

JVC

CAMCORDER

Detailed User Guide

GS-TD1BEK

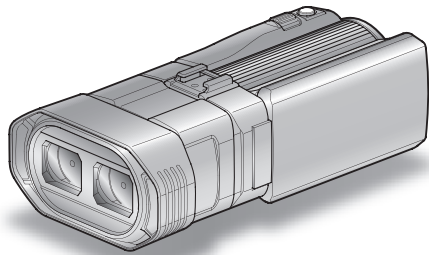

Everio

Table of Contents

Beginner's Guide 4

Charging	4
Recording	4
Playback	4
Shooting Tips	4
Holiday Season/Christmas	5
Wedding	6
Travel	7
Amusement Park	9

Getting Started

Precautions on Recording and Playing Back 3D Images	11
Verifying the Accessories	13
Charging the Battery Pack	15
Grip Adjustment	16
Inserting an SD Card	16
Types of Usable SD Card	17
Using the Touch Screen	18
Names of Buttons and Functions on the LCD Monitor	18
Clock Setting	19
Resetting the Clock	20
Changing the Display Language	21
Holding this Unit	22
Tripod Mounting	22
Using the Remote Control	22
Attaching Headphones	23
Attaching an External Microphone	24
Using this Unit Overseas	24
Charging the Battery Pack Overseas	24
Setting the Clock to Local Time when Traveling	25
Setting Daylight Saving Time	25
Optional Accessories	26

Recording

Taking Videos in 3D Mode	27
Taking Still Images in 3D Mode	29
Taking Videos in Intelligent Auto Mode	30
Zooming	32
Taking Still Images in Intelligent Auto Mode	33
Zooming	35
Adjusting Parallax During Recording	35
Manual Recording	36
Scene Selection	37
Adjusting Focus Manually	38
Using Focus Assist	39
Adjusting Brightness	39
Setting Shutter Speed	40
Setting Aperture	40
Setting White Balance	41
Setting Backlight Compensation	42
Taking Close-up Shots	42
Setting the USER Button	43
Using the Control Dial for Recording	44
Reducing Camera Shake	45
Capturing Subjects Clearly (TOUCH PRIORITY AE/AF)	45
Capturing Smiles Automatically (SMILE SHOT)	46
Recording at Intervals (TIME-LAPSE RECORDING)	47
Taking Group Shots (Self-timer)	49
Remaining Recording Time/Battery Power	50

Playback

Playing Back Videos	53
Playing a Video with Defective Management Information ...	55
Playing Back Still Images	56
Adjusting Parallax During Playback	57
Slideshow Playback	58

Searching for a Specific Video/Still Image	59
Date Search	59
Connecting to and Viewing on TV	59
Playing Back 3D Images	59
Playing Back 2D Images	61
Playing Back a DVD or Blu-ray Disc Created on this Unit	64
Digest Playback on a Blu-ray or DVD Player	66

Editing

Deleting Unwanted Files	67
Deleting the Currently Displayed File	67
Deleting Selected Files	67
Protecting Files	68
Protecting/Releasing Protection of the Currently Displayed File	68
Protecting/Releasing Protection of Selected Files	68
Capturing a Still Image in the Video during Playback	69
Capturing a Required Part in the Video (TRIMMING)	70
Capturing Videos for Uploading to YouTube	71

Copying

Copying Files	72
Creating Discs with a DVD Writer	74
Preparing a DVD Writer (CU-VD50)	75
Preparing a DVD Writer (CU-VD3)	75
Creating a Disc	75
Playing Back with a DVD Writer	79
Finalizing Discs After Copying	80
Creating Discs with an External Blu-ray Drive	80
Preparing an External Blu-ray Drive	81
Creating a Disc	81
Playing Back with an External Blu-ray Drive	84
Creating a Disc Using a Connected Blu-ray Recorder	85
Dubbing Files by Connecting to a DVD Recorder	86
Using a USB External Hard Disk Drive	86
Preparing a USB External Hard Disk Drive	87
Copying All Files	87
Playing Back Files in the USB External Hard Disk Drive	88
Deleting Folders in the USB External Hard Disk Drive	89
Formatting the USB External Hard Disk Drive	90
Importing Files from the USB External Hard Disk Drive	90
Dubbing Files to a VHS Tape Using a VCR	91
Copying Files to an SD Card	92
Moving Files to an SD Card	93
Copying to Windows PC	94
Verifying System Requirements (Guideline)	95
Installing the Provided Software	95
Backing Up All Files	96
Organizing Files	97
Recording Videos to Discs	98
Backing Up Files Without Using Provided Software	99
List of Files and Folders	100
JVC Software Licence Agreement	101

Menu Settings

Operating the Menu	102
Operating the Main Menu	102
Operating the Common Menu	102
Main Menu for Video Recording	103
SCENE SELECT	105
FOCUS	105
FOCUS ASSIST	105
FOCUS ASSIST COLOR	105
BRIGHTNESS ADJUST	105
SHUTTER SPEED	105
APERTURE PRIORITY	105
WHITE BALANCE	105
BACKLIGHT COMP.	105
TELE MACRO (2D mode only)	105
TOUCH PRIORITY AE/AF	105

DIS	105
GAIN UP	106
WIND CUT	106
GRID	107
TIME-LAPSE RECORDING	107
3D VIDEO REC FORMAT (3D mode only)	107
VIDEO QUALITY	108
ZOOM (2D mode only)	109
x.v.Color (2D mode only)	110
USER BUTTON SETTING	110
3D SOUND	110
MIC LEVEL	111
MIC LEVEL SETTING	111
HEADPHONE VOL. ADJ.	112
Main Menu for Still Image Recording	113
SCENE SELECT	115
FOCUS	115
FOCUS ASSIST	115
FOCUS ASSIST COLOR	115
BRIGHTNESS ADJUST	115
SHUTTER SPEED	115
APERTURE PRIORITY	115
WHITE BALANCE	115
BACKLIGHT COMP.	115
TELE MACRO (2D mode only)	115
TOUCH PRIORITY AE/AF	115
SMILE SHOT	115
SMILE LEVEL	115
SELF-TIMER	115
GAIN UP	116
GRID	116
SHUTTER MODE	117
CONT. SHOOTING SPEED	117
IMAGE SIZE	118
USER BUTTON SETTING	118
Main Menu for Video Playback	119
SEARCH DATE	120
PROTECT/CANCEL	120
COPY	120
MOVE	120
TRIMMING	120
UPLOAD SETTINGS	120
PLAYBACK OTHER FILE	120
3D MOTION RELIEF (3D mode only)	120
Main Menu for Still Image Playback	121
SEARCH DATE	121
PROTECT/CANCEL	121
COPY	121
MOVE	121
Common Menu	122
CLOCK ADJUST	124
DATE DISPLAY STYLE	124
LANGUAGE	125
MONITOR BRIGHTNESS	125
REC MEDIA FOR VIDEO	125
REC MEDIA FOR IMAGE	126
OPERATION SOUND	126
AUTO POWER OFF	127
QUICK RESTART	127
REMOTE	128
DEMO MODE	128
TOUCH SCREEN ADJUST	129
3D DISPLAY WARNING (3D mode only)	130
VIDEO OUTPUT (2D mode only)	130
HDMI OUTPUT	131
HDMI CONTROL	132
AUTO FINALIZE	133
FACTORY PRESET	133
UPDATE	133
FORMAT BUILT-IN MEM.	134
FORMAT SD CARD	134
ERASE ALL DATA	135

Names of Parts

Front	136
Rear	136
Bottom	137
Interior	137

Indications on the LCD monitor

Common Recording Indications	138
Video Recording	138
Still Image Recording	139
Video Playback	139
Still Image Playback	140

Troubleshooting

Battery Pack	141
Recording	141
Card	142
Playback	142
Editing/Copying	143
Computer	143
Screen/Image	144
Other Problems	144
Error Message?	145

Maintenance 146

Specifications 147

Charging

- Refer to the operating instructions found in the animation on the Detailed User Guide.

Recording

- Refer to the operating instructions found in the animation on the Detailed User Guide.

Playback

- Refer to the operating instructions found in the animation on the Detailed User Guide.

Shooting Tips

Basic Way to Hold a Camcorder ~ Recording Stable Images ~



This is the standard way of shooting while standing up. Be sure to master this basic technique in order to achieve stable images.

■ [Getting Ready]

- 1 Open your feet to the width of your shoulders.
- 2 Keep the elbow of your right arm, which is holding the camcorder, close to your side.
- 3 Hold the LCD monitor with your left hand and adjust the angle accordingly.

Extending Your Hands to Shoot ~ High-Angle Shooting ~



Extend your hand when your subject is being hidden behind a crowd of people.

■ [Getting Ready]

- 1 Open your feet to the width of your shoulders.
- 2 Extend your right hand and hold the camcorder over your head.
- 3 Hold the LCD monitor with your left hand and adjust the angle accordingly.

Caution :

- Use this way of shooting only as a last resort as it is difficult to achieve stable images.
- Set to the wide angle as much as possible as the image will be prone to camera shake.
- Be considerate. Do not inconvenience the people around you.

Squatting and Shooting at Eye Level



Staying low is a common position to take when shooting small children. By recording from the eye level of the child, you can capture all his cute expressions clearly.

■ [Getting Ready]

- 1 Kneel down with your left knee while keeping your right foot on the ground.
- 2 Place the elbow of your right arm, which is holding the camcorder, on your right knee.
- 3 Hold the LCD monitor with your left hand and adjust the angle accordingly.

Caution :

- To record 3D images, refer also to “Precautions on Recording and Playing Back 3D Images”.

“Precautions on Recording and Playing Back 3D Images” (p. 11)

Holiday Season/Christmas

Record the happy Christmas celebration with your family!



Photo by 101st CAB, Wings of Destiny
[Creative Commons Attribution-No Derivative Works 3.0](#)

Decorating the Tree and Preparing the Dinner

The decoration of tree and preparation of dinner are part of the joy of Christmas. Be sure to record these happy family times!

■ Decorating the tree



A tree is the most important thing to bring out the mood of Christmas. Simply the scene of all family members engaging in the decorating of a fir tree with various colorful ornaments is full of the feeling of happiness.

■ Preparing the Dinner



Photo by Manicosity
[Creative Commons Attribution-No Derivative Works 3.0](#)
 Record the scenes as everyone helps to prepare the feast of the night. You can film the mother who is cooking, the children who are helping, and of course, the process of making a cake!

Recording the Christmas Party



Photo by InnerSpirit
[Creative Commons Attribution-No Derivative Works 3.0](#)

After all preparations, it is finally the Christmas party itself. Not only should you record the candle-blowing scene, but also the smiles of the family while being surrounded by good food, or even the father who is slightly drunk from champagne!

Finding the Presents



For children, the greatest joy of Christmas is receiving presents the next morning. Their expression of delight when finding a present next to their pillow is a recording opportunity not to be missed. Get ready to shoot before the children wake up!

Wedding

Create an awesome wedding video for the bride and groom!



Discussing and Planning Before the Event

Before the day of the wedding reception, it is important to discuss with the bride and groom about various details such as the order of the ceremony and whether there are any entertainment programs or change of clothes. By understanding the preferences of the bride and groom, you will be able to shoot more appropriately.

Finding the Right Angle to Capture Both Bride and Groom

- Composing the picture with the groom in front and the guests at the back



The main characters of a wedding are of course the bride and groom. Record their expressions clearly during the toast, speech, entertainment programs, and other scenes.

Another recommendation is to capture the face shots of the guests, then pan towards the groom. Picture composition containing the crowd of guests only lacks fun, so be sure to pay attention to the shooting angle and size.

Recording the Expressions and Comments of Guests

- Setting the shot from eye level to chest level



You can record comments from the guest by going around asking, "Please say a few words for the bride and groom".

This can be done at the guests' waiting room, when the bride and groom are changing, or during the entertainment programs.

Closing Up on the Bride's Face During the Thank You Speech

The climax of the event finally comes during the bride and groom's thank you speech and presentation of flowers. The touching words of appreciation from the bride and tears of joy from the parents are scenes that must not be missed.

Start by closing up on the bride's face using zoom. As the tears start to form in the bride's eyes, continue shooting for a little longer. Then, slowly zoom out to the wide angle to show the parents who are moved by the speech.

Advanced Operation with Two Camcorders

If video-editing is to be done, record using two camcorders so that a video with varying scenes can be created. You can try asking a close friend who has a camcorder at home.

Set the borrowed camcorder on a tripod to focus on taking close-up shots of the bride and groom. In this way, the other camcorder can be moved around to record other scenes, enabling an interesting video with changing scenes to be created through editing and compilation.

As most people own at least a digital camera nowadays, even if you are really unable to find an extra camcorder, inserting still pictures to the video at various points is also a good way to add variety. Do give it a try!

- <Camcorder 1>
Closing up on the bride and groom all the time

- <Camcorder 2>
Recording the congratulatory messages from friends at the same time



Travel

Capture all the good times of your domestic or overseas trips!



Bringing the Necessary Equipment

The necessary things to bring on a trip depends on your traveling purpose and the destination.

For overseas trips in particular, you have to think about what to bring in accordance to the local conditions.

Here are some suggestions for your consideration.

■ Camcorder

Think about how many hours of shooting you will usually perform in a day. Be sure to prepare enough recording medium especially for long overseas trips.

If you are recording in SD cards, get ready the sufficient number of cards, including some for backup.

■ Battery Pack

Prepare a battery pack that is ready for double the expected recording time in a day. For example, if you plan to record for 2 hours a day, prepare a battery pack that is ready for 4 hours (actual recording time).

For a day trip, you can prepare a battery with low capacity but for a long trip, do prepare a few batteries with high capacities.

■ AC Adapter

The JVC AC adapter supports voltages from 100 V to 240 V, and hence can be used anywhere in the world.

Bring along the adapter if you are traveling for a long time. Charge the battery pack while sleeping so that you can record with full battery power the next day.

■ Power Plug Adapter



The shape of the power plug varies according to countries. Be sure to check the shape of the power plug beforehand, and bring the appropriate power plug adapter.

"Charging the Battery Pack Overseas" (☞ p. 24)

■ Battery Charger



Recording cannot be performed when an AC adapter is connected to the camcorder for battery charging.

You can bring an additional battery charger to charge battery packs if you plan to use the camcorder for recording at night. You can also charge multiple battery packs by using both the battery charger and this camcorder at the same time.

■ Tripod



A tripod is an essential item to take stable images. Select an appropriate tripod in accordance to your purpose and style of traveling, such as a compact one to be used on a table or one that is at least 1 m tall.

Recording the Excitement Before Departure

It may be a little abrupt to start your travel video at the destination suddenly. Record also the preparations prior to departure if it is a family trip, or the time when everyone is gathered at the meeting place if you are traveling with your friends.

For overseas trips, taking a shot of the signs and displays at the airport of the flight you are taking may be useful for future reference.



Useful Shooting Techniques

Using Pan at the Places of Interest

Tourists spots with beautiful scenery or historical sites are places that you would certainly want to record.

To capture the magnificence of a scene which cannot be fitted into a single frame, try the panning technique.

Refer to the "Shooting Tips" found in this website on how to use panning effectively.

In addition, you may also like to take a shot of the signs or monuments that can often be found at the tourist spots.



Showing Everyone Having a Good Time

When taking a video, it is rather dull to shoot only the scenery or historical sites.

Talk about your feelings while recording the breath-taking scenery of an attraction so that it will be an interesting scene to view later.

Amusement Park

Take more shots of the smiling faces of everyone in the family!



Taking Videos or Still Images According to the Attraction

You may choose to take videos all the time. However, you may want to take some still images too.

The following section explains the scenarios suitable for taking videos or still images.

■ Scenarios suitable for taking videos



Scenarios with changes in body movement are suitable for taking videos. This includes situations where there are rapid changes in facial expressions or voices of surprise and delight.

*Some amusement parks do not allow passengers to perform any recording. Be sure to check beforehand.

[Examples]

- Merry-go-round, go kart, coffee cup, etc.

■ Scenarios suitable for taking still images (photos)



Scenarios with little movement of the subject are suitable for taking still images.

Try to take the still images from an angle such that the surroundings can be seen clearly.

[Examples]

- Carousel, ferris wheel, fun bicycle rides, etc.

Inducing Responses by Calling Out



Videos with no waving of hands nor laughter are not only dull when you view them later, but also put the capability of the audio-recording function of the camcorder to a waste.

When recording, induce more reactions by enthusiastically waving your hands or shouting out "Is it fun?" and the like.

Capturing the Best Moment in a Video as a Still Image

Shots with the eyes closed are often taken by accident. To reduce such mistakes, make use of the function to capture still images from videos.

As videos are actually continuous recording of 60 still images within 1 minute, using this function allows you to select the best moment and save it as a still image.

"Capturing a Still Image in the Video during Playback" (p. 69)



Photo by just that good guy jim

[Creative Commons Attribution-No Derivative Works 3.0](#)

Video Playback in Progress



Photo by talk rhubarb

[Creative Commons Attribution-No Derivative Works 3.0](#)

Capturing a Still Image



Photo by just that good guy jim

[Creative Commons Attribution-No Derivative Works 3.0](#)

Video Playback in Progress

Advanced Operation with Backlight Compensation

When the subject's face is in backlight or when the expression cannot be seen clearly, the Intelligent Auto function of this unit automatically increases its brightness for recording.

If Intelligent Auto fails to function as expected or if the brightness correction is insufficient, you can increase the brightness by using backlight compensation in the Manual mode.

"Setting Details" (☰ p. 42)

■ <Without backlight compensation>



■ <With backlight compensation>



Precautions on Recording and Playing Back 3D Images

3D images can be recorded and played back on this unit. You can enjoy realistic and powerful 3D images recorded on this unit by playing back on a 3D compatible TV. Before use, please read the following precautions to ensure safe and comfortable viewing of the 3D images.

Recording 3D Images

This unit makes use of the misalignment between the images that enter the left and right eyes to create the 3D effect during 3D recording. As the images that enter the left and right eyes are different, fatigue may be experienced. In addition, depending on the content of the video, an illusion of movement may be experienced and result in motion sickness. Take note of the following when recording 3D images.

■ Basic Way to Hold a Camcorder During 3D Recording (Recording Stable Images)

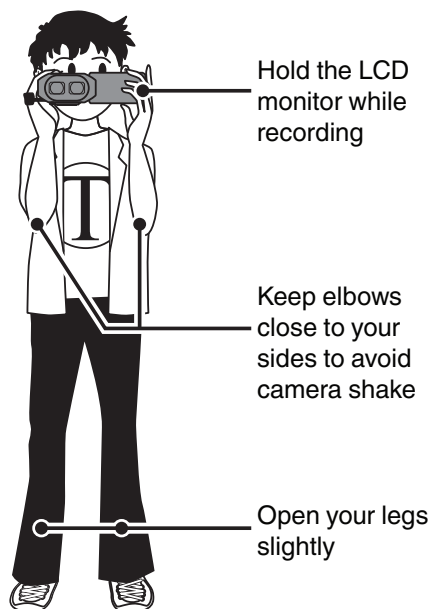

■ Shooting Distance During 3D Recording (Achieving Comfortable 3D Images)

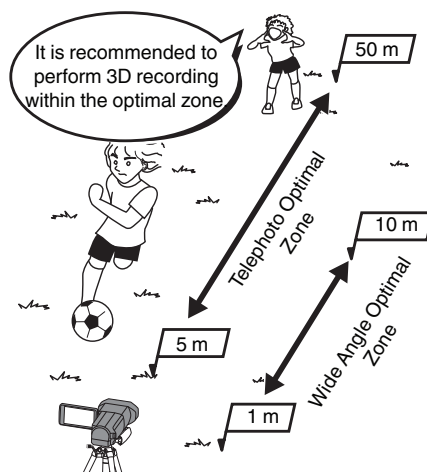

Memo :

- Make sure that you have stable footing during recording.
- Do not swing the camera horizontally or vertically during recording.
- If the subject is not recorded within the recommended shooting distance, 3D effect may be weak.
- When recording night scenes or landscapes, 3D effect of some subjects may be weak.
- For subjects that appear at the side of the screen, 3D effect may be weak.
- Operate slowly when using the zoom.
- If the image is zoomed in too much, 3D effect may be weak.
- It is recommended to make use of a tripod.

* If you do not take note of the above points during 3D recording, the recorded scenes may be played back in stop-motion during playback. "3D MOTION RELIEF (3D mode only)" (p. 120)

3D Display on the LCD Monitor

The LCD monitor supports 3D images during both recording and playback. Press the “3D/2D” button on the touch screen to change the display on the LCD monitor between 3D and 2D.

- When using the 3D recording mode, the image will be recorded in 3D even if the display on the LCD monitor is set to 2D.
- 3D effect appears stronger when viewed at approximately 30 cm from the front.
- 3D effect may be weak if viewed from an angle other than the front.
- The LCD monitor appears darker when 3D images are displayed. Change the display to 2D when it is difficult to see, such as when using this unit outdoors.

Caution :

- Recording and viewing of the 3D images is not recommended for people with medical history of photosensitivity, heart diseases, feel sick, suffer from lack of sleep, suffer from fatigue, or are drunk.

Medical conditions may worsen.

- Do not shoot a subject from a distance shorter than the minimum shooting distance.

The 3D effect may become stronger and result in fatigue or discomfort.

The minimum shooting distance of this camera is 80 cm (using wide angle).

- Be careful not to shake the camera during recording.

Excessive shaking while riding in a vehicle or during walking may result in fatigue or discomfort.

To perform recording while moving the camera, keep the speed slow and steady.

Keep the camera in a horizontal position, as much as possible, during recording.

- If you have vision problems such as short-sightedness, long-sightedness, varying vision in the left and right eyes, or astigmatism, it is recommended to correct your vision by wearing glasses, etc.

Stop recording or viewing of the 3D images if you see double images.

3D images may appear differently for different people. Correct your vision appropriately before viewing the 3D images.

- Stop recording or viewing of the 3D images if you experience fatigue or discomfort.

Continual recording or viewing of the 3D images may result in health problems.

Take an adequate rest.

Recording or viewing of the 3D images in an environment where shaking of the monitor is expected, such as while riding in a vehicle or during walking, may result in fatigue or discomfort.

- If you experience fatigue or discomfort while recording or viewing of the 3D images on the LCD monitor, set the display to 2D.

Continual recording and viewing of the 3D images may result in health problems.

- Rest well after recording or viewing of the 3D images.

After recording or viewing of the 3D images, check that you do not experience fatigue or discomfort before driving, etc.

- Take a break every 30 to 60 minutes when recording or viewing of the 3D images.

Long periods of recording or viewing may cause visual fatigue.

- Keep a distance of at least 3 times the effective height of the screen when viewing of the 3D images on a 3D compatible TV.

Viewing of the 3D images from a distance shorter than the recommended distance may cause visual fatigue.

TV Size	Recommended Distance
54"	Approx. 2.0 m
50"	Approx. 1.9 m
46"	Approx. 1.7 m
42"	Approx. 1.6 m

- Recording and viewing of the 3D images is only recommended for ages 5 to 6 and above.

Guardians should pay close attention to children as health problems may result if fatigue and discomfort are not noticed immediately.



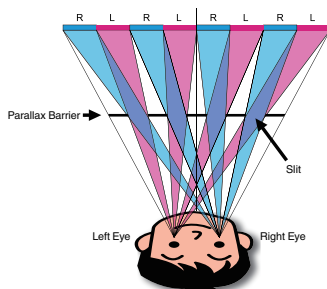

3D Effect Mechanism

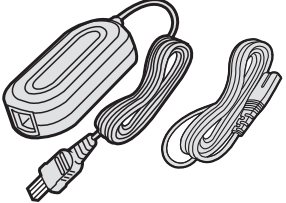
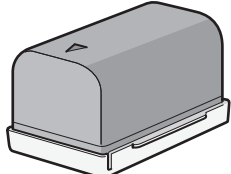
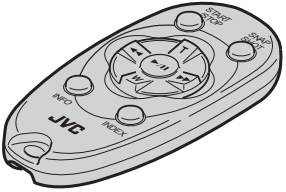
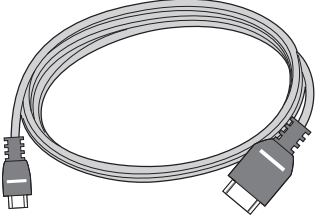
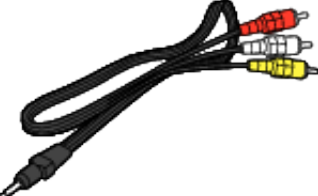

3D images on the LCD monitor of this unit are displayed using the parallax barrier system. Placed in front of an image source, a parallax barrier consists of a series of slits arranged alternately for the left and right eyes, allowing each eye to see a different image when viewing from a distance, thus creating the 3D effect. As such, 3D effect may appear weak depending on the angle of viewing.

Verifying the Accessories

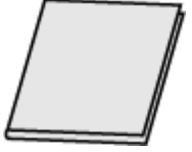
If any of the items are missing or defective, consult your JVC dealer or the nearest JVC service center.

Illustration	Description
	<p>AC Adapter AP-V20M</p> <ul style="list-style-type: none"> Connects to this unit to charge the battery pack. It can also be used when recording or playing back videos indoors.
	<p>Battery Pack BN-VF815U</p> <ul style="list-style-type: none"> Attaches to this unit to supply power.
	<p>Remote Control RM-V760U</p> <ul style="list-style-type: none"> Operates certain functions from a distance.
	<p>HDMI Mini Cable</p> <ul style="list-style-type: none"> Connects this unit to a TV to play back recorded images on the TV in a better quality.
	<p>AV Cable</p> <ul style="list-style-type: none"> Connects this unit to a TV to play back recorded images on the TV.
	<p>USB Cable (Type A - Mini Type B)</p> <ul style="list-style-type: none"> Connects this unit to a computer.
	<p>Basic User Guide</p> <ul style="list-style-type: none"> Read well and keep in a safe place where it can be accessed easily when necessary.
	<p>CD-ROM</p> <ul style="list-style-type: none"> For installing the provided software Everio MediaBrowser 3D on a computer.

Memo :

Getting Started

SD cards are sold separately.

“Types of Usable SD Card” (☞ p. 17)

When using the AC adapter overseas, please prepare a commercially available converter plug for the country or region of visit.

“Charging the Battery Pack Overseas” (☞ p. 24)

Charging the Battery Pack

Charge the battery pack immediately after purchase and when the remaining battery power is low.

The battery pack is not charged at the time of purchase.

1 Attach the battery pack.

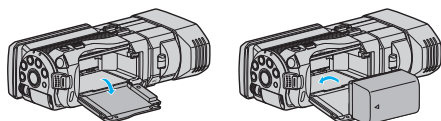

- Align the top of the battery with the mark on this unit, and slide in until the battery clicks into place.

2 Connect the AC adapter to the DC connector.

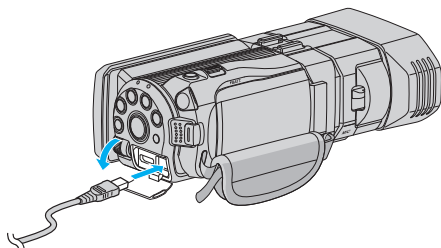

3 Plug in the power.

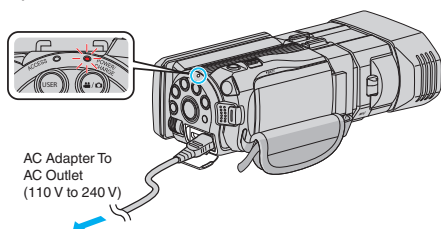

- The charging lamp blinks when charging is in progress. It goes out when charging is finished.

Caution :



Be sure to use JVC battery packs.

- If you use any other battery packs besides JVC battery packs, safety and performance cannot be guaranteed.
- Charging time: Approx. 2 h 40 m (using supplied battery pack)
The charging time is when the unit is used at 25°C. If the battery pack is charged outside the room temperature range of 10°C to 35°C, charging may take a longer time or it may not start. The recordable and playable time may also be shortened under some usage conditions such as at low temperature.

Be sure to use the supplied JVC AC adapter.

- If you use any other AC adapters besides the supplied JVC AC adapter, malfunctions may occur.

Rechargeable Batteries :

- When using the battery in a low temperature environment (10°C or below), the operating time may be shortened, or it may not function properly. When using this unit outdoors in the winter weather, warm the battery, such as by placing it in the pocket, before attaching it. (Keep away from direct contact with a warm pack.)
- Do not expose the battery to excessive heat, such as direct sunlight or fire.
- After removing the battery, store it in a dry place between 15°C to 25°C.
- Keep a 30 % battery level () if the battery pack is not to be used for a long period of time. In addition, fully charge and then fully discharge the battery pack every 2 months, then continue to store it at a 30 % battery level ().

Memo :

- You can connect this unit to the AC adapter to record for long hours indoors.
(Battery charging begins when the LCD monitor is closed.)

Detaching the Battery Pack

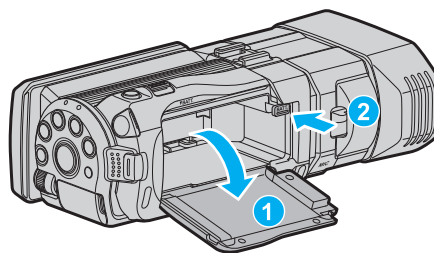

Press the battery release lever to detach the battery from this unit.

Approximate Battery Charging Time (Using AC Adapter)

Battery Pack	Charging Time
BN-VF815U (Supplied)	2 h 40 m
BN-VF823U	3 h 40 m

- When the battery life is reached, the recording time becomes shorter even if the battery pack is fully charged.
(Replace the battery pack with a new one.)

* The charging time is when the unit is used at 25°C. If the battery pack is charged outside the room temperature range of 10°C to 35°C, charging may take a longer time or it may not start. The recordable and playable time may also be shortened under some usage conditions such as at low temperature.
“Approximate Recording Time (Using Battery)” ( p. 52)

Grip Adjustment

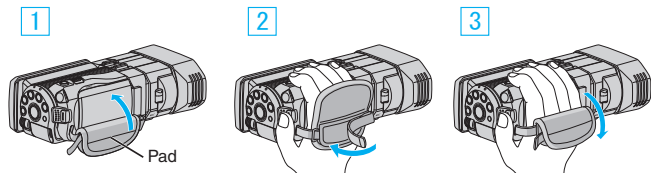

- 1 Pull back the belt
- 2 Adjust the length
- 3 Attach the belt

Caution :

- Be sure to fasten the grip belt properly.
If the belt is loose, this unit may drop and result in injuries or damages.

Inserting an SD Card

When a commercially available SD card is inserted, recordings can be made to either the card or built-in memory separately.

“Types of Usable SD Card” (☞ p. 17)

“Approximate Video Recording Time” (☞ p. 51)

- 1 Open the LCD monitor.

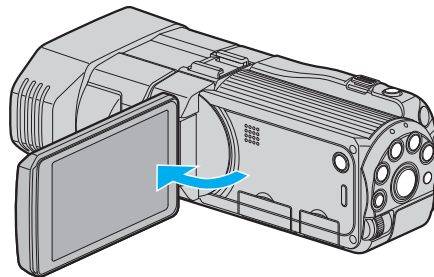

- 2 Press and hold the  button for 2 seconds or more to turn off the power.
- 3 Open the cover.

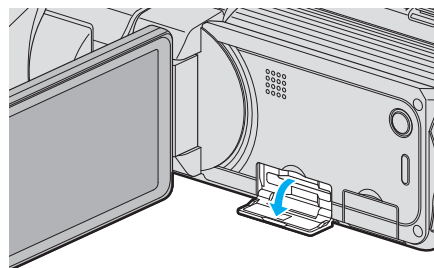

- 4 Insert an SD card.

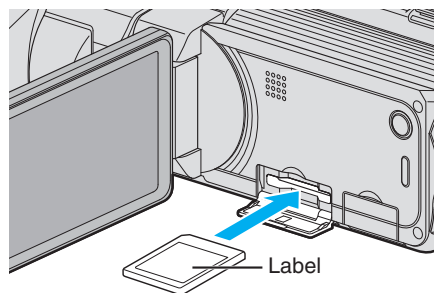

- Insert with the label facing upwards.

Warning

- Make sure not to insert the card in the wrong direction. It may cause damage to the unit and card.
- Turn off the power of this unit before inserting or removing a card.
- Do not touch the metal contact area when inserting the card.

Memo :

- To record to the card, it is necessary to perform media settings. When no card is available, set media settings to “BUILT-IN MEMORY” for recording.

“REC MEDIA FOR VIDEO” (☞ p. 125)

“REC MEDIA FOR IMAGE” (☞ p. 126)

- To use cards that have been used on other devices, it is necessary to format (initialize) the card using “FORMAT SD CARD” from media settings.

“FORMAT SD CARD” (☞ p. 134)

Removing the Card

Push the SD card inward once, then pull it out straight.

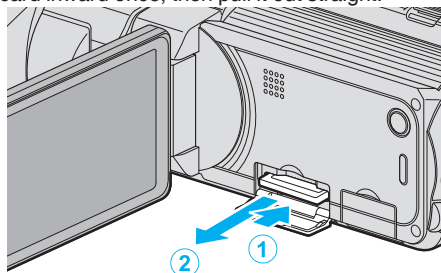

Types of Usable SD Card

The following SD cards can be used on this unit.

Operations are confirmed on the SD cards from the following manufacturers.

- Panasonic
- TOSHIBA
- SanDisk

SD Card



- This unit supports 256 MB to 2 GB SD cards.
- Use a Class 4 or higher compatible SD card (2 GB) for video recording.

SDHC Card



- Use a Class 4 or higher compatible SDHC card (4 GB to 32 GB) for video recording.

SDXC Card



- Use a Class 4 or higher compatible SDXC card (Max. 64 GB) for video recording.

Memo : _____

- Using SD cards (including SDHC/SDXC cards) other than those specified above may result in recording failure or data loss.
- To record videos with "VIDEO QUALITY" set to "THR", use of a Class 10 card is recommended. (Class 6 or higher SDHC/SDXC card is required.)
- To record videos with "VIDEO QUALITY" set to "UXP", use of a Class 6 compliant SDHC/SDXC card is recommended.
- Class 4 and Class 6 are guaranteed to have a minimum transfer rate of 4 MB/s and 6 MB/s respectively during reading or writing of data.
- You can also use a Class 10 compliant SDHC/SDXC card.
- To protect the data, do not touch the terminals of the SD card.
- Both videos and still images can be recorded on one SD card.

For customers who completed the firmware update: _____

- To record in "AVCHD 3D" mode, use of a Class 10 is recommended. (Class 6 or higher SDHC/SDXC card is required.)

When your computer cannot recognize the SDXC card

Confirm and update the OS of your computer.

Windows XP / Windows XP SP1	Necessary to update to SP2 or higher.
Windows XP SP2 / Windows XP SP3	Necessary to download the update software. (KB955704) http://www.microsoft.com/downloads/details.aspx?FamilyID=1cbe3906-ddd1-4ca2-b727-c2dff5e30f61&displaylang=en
Windows Vista	Necessary to update to SP1 or higher.
Windows Vista SP1 / Windows Vista SP2	Necessary to download the update software. (KB975823) <ul style="list-style-type: none"> • 32 bit version http://www.microsoft.com/downloads/en/details.aspx?FamilyID=2d1abe01-0942-4f8a-abb2-2ad529de00a1 • 64 bit version http://www.microsoft.com/downloads/en/details.aspx?FamilyID=7d54c53f-017c-4ea5-ae08-34c3452ba315
Windows 7	Necessary to download the update software. (KB976422) <ul style="list-style-type: none"> • 32 bit version http://www.microsoft.com/downloads/en/details.aspx?FamilyID=3ee91fc2-a9bc-4ee1-aca3-2a9aff5915ea • 64 bit version http://www.microsoft.com/downloads/en/details.aspx?FamilyID=73f766dd-7127-4445-b860-47084587155f

Using the Touch Screen

Icon operation buttons, thumbnails, and menu items are displayed on the touch screen according to the mode in use.

- To operate, tap the icon operation buttons, thumbnails, or menu items on the touch screen lightly.
- There are two ways to operate the touch screen, namely “tap” and “drag”. The following are some examples.

- **A** Tap the displayed button (icon) or thumbnail (file) on the touch screen to make selection.

- **B** Drag the thumbnails on the touch screen to search for the desired file.



- The touch screen of this unit is pressure-sensitive. When the touch screen does not respond smoothly, apply slightly more force to your fingertip.
- Do not press or rub with excessive force.
- If you apply a protect sheet or a sticker, the touch screen may not respond smoothly.
- Do not operate the touch screen using an object with a sharp or hard tip.
- Pressing two or more places at a time may cause a malfunction.
- Tap the buttons (icons) on the touch screen accurately. The buttons may not respond if they are not tapped on the right area.
- Perform “TOUCH SCREEN ADJUST” if the reactive area of the screen is misaligned with the touched area. (Adjust by lightly tapping with a corner of an SD card, etc. Do not press with an object with a sharp tip or do not press hard.)

“TOUCH SCREEN ADJUST” (p. 129)

Names of Buttons and Functions on the LCD Monitor

The following screens are displayed during the video and still image modes, and operate as the touch screens.

Recording Screen (Video/Still Image)

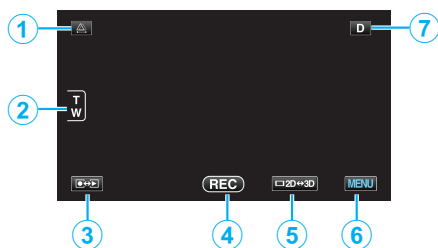

- 1 Parallax Adjustment Button**
 - Adjusts the 3D effect when 3D images are displayed on the LCD monitor.

“Adjusting Parallax During Recording” (p. 35)
- 2 Zoom Button**
 - “Zooming” (p. 32)
- 3 Recording/Playback Mode Button**
 - Switches between recording and playback modes.
- 4 Recording Start/Stop Button**
 - **REC**: Video Recording Start Button
 - **●||**: Video Recording Stop Button
 - **🌀**: Still Image Recording Button
- 5 LCD Monitor 3D/2D Display Switching Button**
 - Switches the display on the LCD monitor between 3D and 2D. The image will be recorded in 3D even if the display on the LCD monitor is set to 2D.
- 6 Menu Button**

“Operating the Menu” (p. 102)

7 Display Button

Some displays disappear after approximately 3 seconds. Use the **D** button to change the displays as shown below.

- Tap **D** button
Displays appear for approximately 3 seconds with every tap.
- Tap and hold **D** button
Displays are fixed such that they do not disappear. After setting, the display button changes from **D** to **D?**. Tap **D?** to release the displays.

Playback Screen (Video)

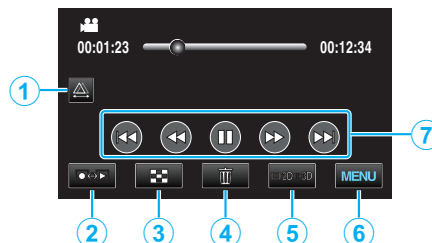

- 1 Parallax Adjustment Button**
 - Adjusts the 3D effect when 3D images are displayed on the LCD monitor.

“Adjusting Parallax During Playback” (p. 57)
- 2 Recording/Playback Mode Button**
 - Switches between recording and playback modes.
- 3 Index Screen Button**
 - “Operation Buttons for Video Playback” (p. 54)
- 4 Delete Button**
 - “Deleting the Currently Displayed File” (p. 67)
- 5 LCD Monitor 3D/2D Display Switching Button**
 - Switches the display on the LCD monitor between 3D and 2D.
- 6 Menu Button**
 - “Operating the Menu” (p. 102)
- 7 Operation Buttons**
 - “Operation Buttons for Video Playback” (p. 54)

Playback Screen (Still Image)

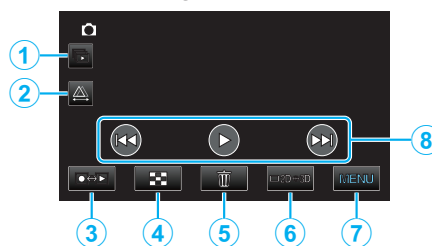

- 1 Group Playback Button**
 - Continuous playback of grouped files (such as still images captured by continuous shooting).

“Playing Back Still Images” (p. 56)
- 2 Parallax Adjustment Button**
 - Adjusts the 3D effect when 3D images are displayed on the LCD monitor.

“Adjusting Parallax During Playback” (p. 57)
- 3 Recording/Playback Mode Button**
 - Switches between recording and playback modes.
- 4 Index Screen Button**
 - “Operation Buttons for Still Image Playback” (p. 56)
- 5 Delete Button**
 - “Deleting the Currently Displayed File” (p. 67)

- 6 LCD Monitor 3D/2D Display Switching Button
 - Switches the display on the LCD monitor between 3D and 2D.
- 7 Menu Button

“Operating the Menu” (☞ p. 102)
- 8 Operation Buttons

“Operation Buttons for Still Image Playback” (☞ p. 56)

Index Screen

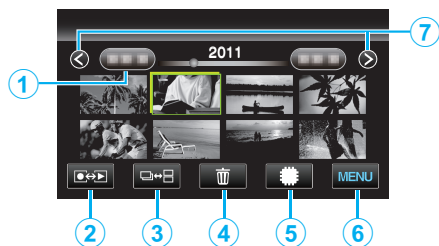

- 1 Date Button

“Operation Buttons for Video Playback” (☞ p. 54)
“Operation Buttons for Still Image Playback” (☞ p. 56)
- 2 Recording/Playback Mode Button
 - Switches between recording and playback modes.
- 3 Index Screen Switching Button (Still image only)
 - Switches between the group or full index screen displays.
- 4 Delete Button

“Deleting Selected Files” (☞ p. 67)
- 5 Playback Media Button
 - Switches between SD card and built-in memory.
- 6 Menu Button

“Operating the Menu” (☞ p. 102)
- 7 Page Forward/Back Button

“Operation Buttons for Video Playback” (☞ p. 54)
“Operation Buttons for Still Image Playback” (☞ p. 56)

Menu Screen



- 1 Help Button

“Operating the Menu” (☞ p. 102)
- 2 Menu Items
- 3 Return Button
- 4 Common Menu Button
- 5 Close Button

“Operating the Menu” (☞ p. 102)

Clock Setting

The “SET DATE/TIME!” screen appears when you turn on this unit for the first time after purchase, when it has not been used for a long time, or when the clock is not set yet.

Set the clock before recording.

- 1 Open the LCD monitor.

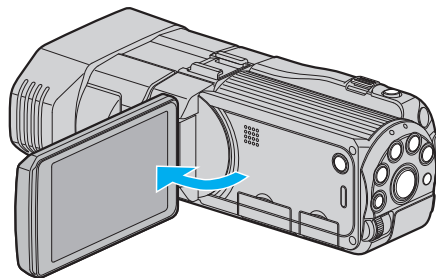

- The unit turns on.
- When the LCD monitor is closed, the unit turns off.

- 2 Tap “YES” when “SET DATE/TIME!” is displayed.

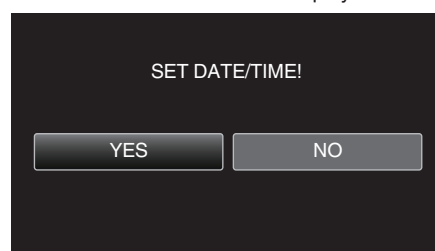

- 3 Set the date and time.

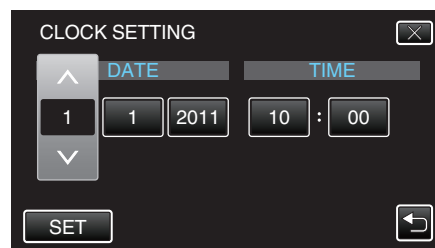

- When the year, month, day, hour, or minute item is tapped, “^” and “v” will be displayed.
- Tap ^ or v to adjust the year, month, day, hour, and minute.

- 4 After setting the date and time, tap “SET”.

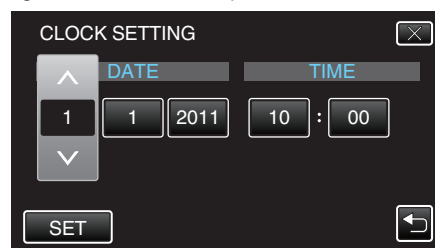

- 5 Select the region where you live and tap “SAVE”.

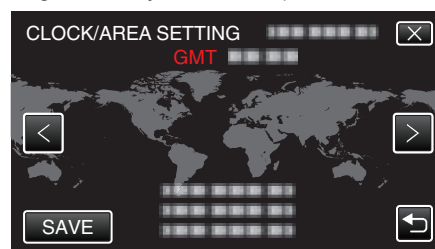

- The city name and time difference are displayed.
- Tap “<” or “>” to select the city name.

Memo :

- The clock can be reset again later.
- “Resetting the Clock” (☞ p. 20)

Getting Started

- When using this unit overseas, you can set it to the local time for recording. “Setting the Clock to Local Time when Traveling” (p. 25)
 - “SET DATE/TIME!” is displayed when you turn on this unit after it has not been used for a prolonged period.
Connect the AC adapter for more than 24 hours to charge the internal clock battery of this unit before setting the clock.
- “Charging the Battery Pack” (p. 15)

Resetting the Clock

Set the clock with “CLOCK ADJUST” from the menu.

- 1 Tap “MENU”.

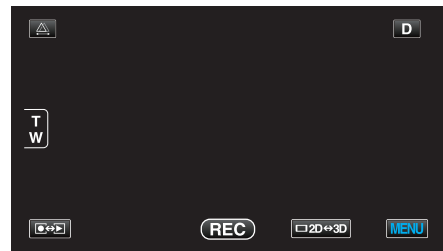

- 2 Tap the gear icon.



- 3 Tap “CLOCK ADJUST”.

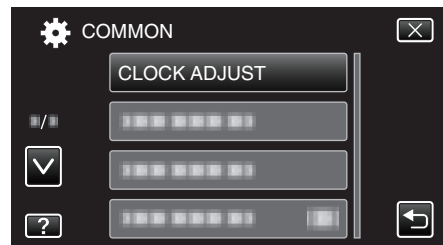

- Tap \wedge or \vee to move upward or downward for more selection.

- 4 Tap “CLOCK SETTING”.

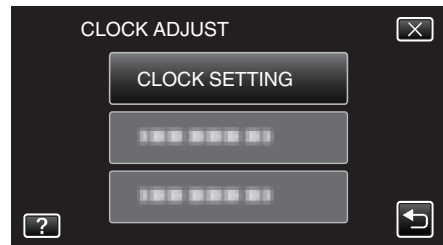

- 5 Set the date and time.

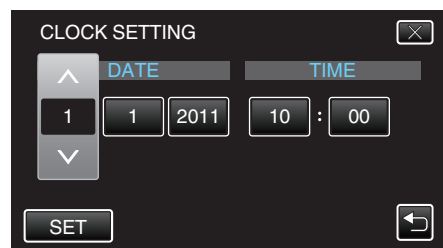

- When the year, month, day, hour, or minute item is tapped, “ \wedge ” and “ \vee ” will be displayed.
- Tap \wedge or \vee to adjust the year, month, day, hour, and minute.

- 6 After setting the date and time, tap “SET”.

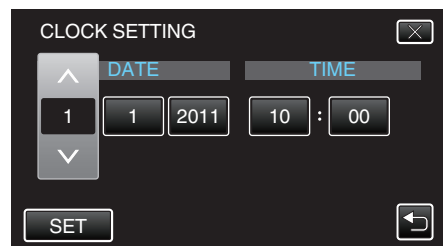

- 7 Select the region where you live and tap "SAVE".

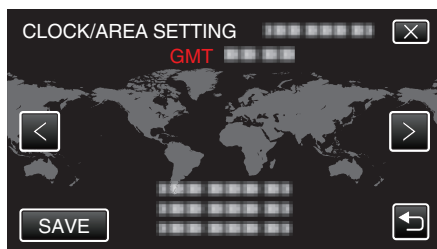

- The city name and time difference are displayed.
- Tap < or > to select the city name.

Changing the Display Language

The language on the display can be changed.

- 1 Tap "MENU".

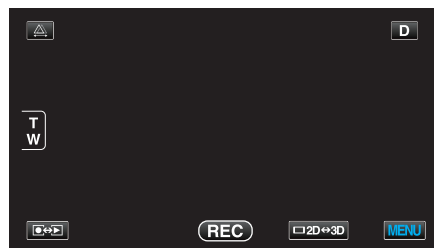

- 2 Tap "⚙️".



- 3 Tap "LANGUAGE".

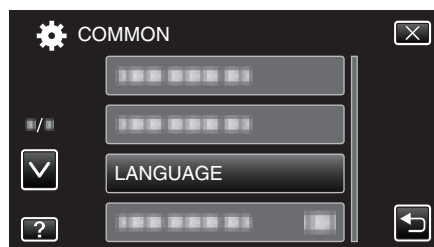

- Tap ^ or v to move upward or downward for more selection.

- 4 Tap to the desired language.

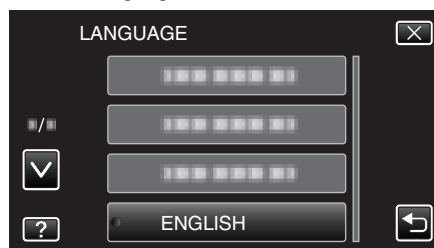

- Tap ^ or v to move upward or downward for more selection.

Holding this Unit

When holding this unit, keep your elbows close to your sides to prevent camera shake.

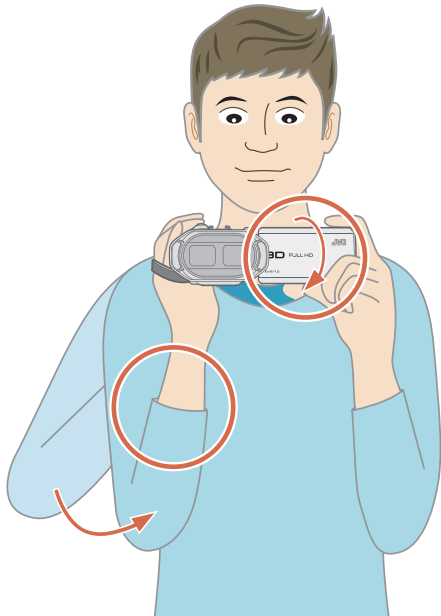

- Hold the LCD monitor with your left hand and adjust the angle accordingly. Holding the LCD monitor with your left hand helps to stabilize the camera for recording.

Caution :

- Be careful not to drop this unit during transportation.
- Guardians should pay close attention when this unit is being used by children.

Memo :

- If camera shake is excessive, use the digital image stabilizer.

“Reducing Camera Shake” (p. 45)

Tripod Mounting

This unit can be mounted on a tripod (or monopod). This is useful for preventing camera shake.

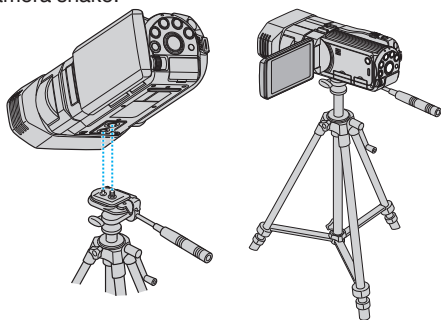

- To prevent this unit from falling off, check the tripod mounting screw holes and positioning holes on the unit carefully before mounting, and turn the screws until they are fastened firmly.

Caution :

- To prevent injuries or damages which may result if this unit falls off, read the instruction manual of the tripod (or monopod) to be used and make sure that it is securely attached.

Memo :

- It is recommended to use a tripod or monopod when recording in conditions prone to camera shake (such as in dark places or when zoomed to the telephoto end).
- Set the digital image stabilizer to (OFF) when using a tripod for recording.

“Reducing Camera Shake” (p. 45)

Using the Remote Control

You can operate this unit from a distance away using the supplied remote control.

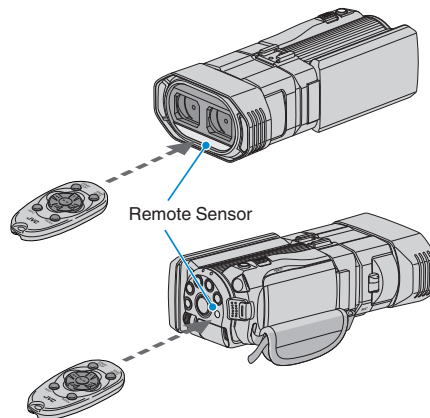

Memo :

- Point the remote control toward the sensor directly and use it within 5 m from this unit.
- The transmitted beam may not be effective or may cause incorrect operation when the sensor is directly exposed to sunlight or powerful lighting.

Preparing the Remote Control

Using the Remote Control for the First Time

Pull out the insulation sheet

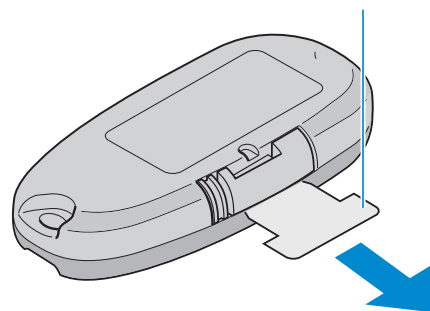

- A button battery (CR2025) is included inside the remote control at the time of purchase. Remove the insulation sheet before use.

Reinserting the Battery

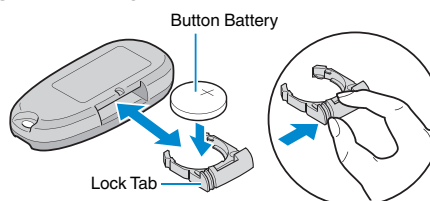

- Pull out the battery holder by pressing the lock tab.
- Insert the button battery with the + side facing upward.

Operation Buttons on Remote Control Unit

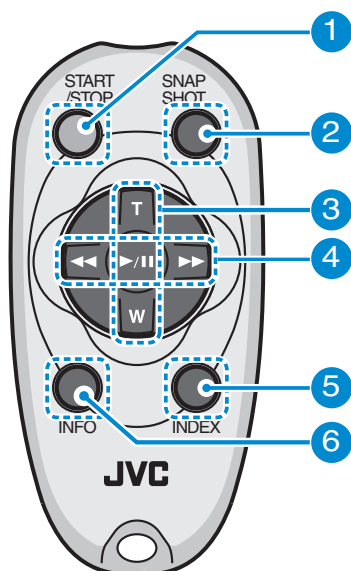

- 1** Recording Start/Stop Button
 - Starts/stops video recording.
- 2** Still Image Button
 - Takes a still image.
- 3** Zoom Button
 - T: Zooms in
 - W: Zooms out
- 4** Basic Playback Operations

Operation Button	Description
Playback/Pause Button ▶ /	<ul style="list-style-type: none"> • Starts/pauses playback of videos or slideshows.
Left Button ◀◀	<ul style="list-style-type: none"> • Moves the cursor to the left. • Performs reverse search during playback.
Right Button ▶▶	<ul style="list-style-type: none"> • Moves the cursor to the right. • Performs forward search during playback.
T Button T	<ul style="list-style-type: none"> • Zooms in. (during pause) • Turns up (+) the volume during video playback.
W Button W	<ul style="list-style-type: none"> • Zooms out. (during pause) • Turns down (-) the volume during video playback.

- 5** Index Button
 - Stops playback and returns to thumbnail display.
- 6** Info Button
 - Recording: Displays the remaining time (for video only) and battery power.
 - Playback: Displays file information such as recording date.

Attaching Headphones

You can attach optional headphones to this unit.

- 1** Open the cover of the headphones connector.

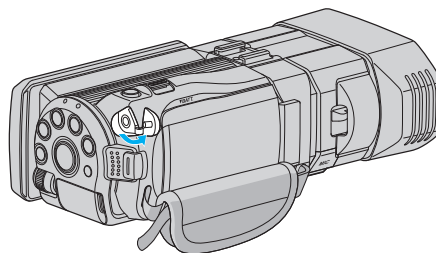

- 2** Connect the headphones to the headphones connector.

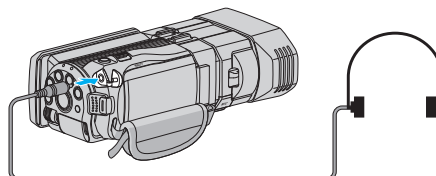

Memo :

- The volume level of the headphones can be adjusted using "HEADPHONE VOL. ADJ." in the menu.
- "HEADPHONE VOL. ADJ." (p. 112)

Attaching an External Microphone

You can attach an external microphone (commercially available) to this unit.

- 1 Attach an external microphone (commercially available) to the shoe.

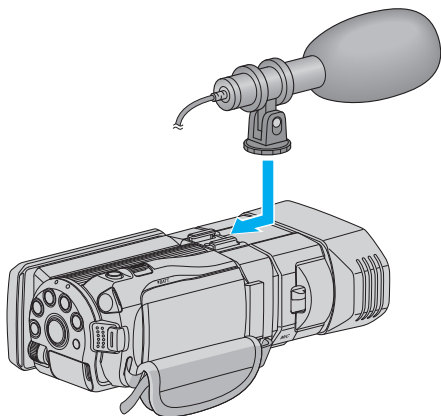

- 2 Open the cover of the microphone connector and connect the cable of the external microphone.

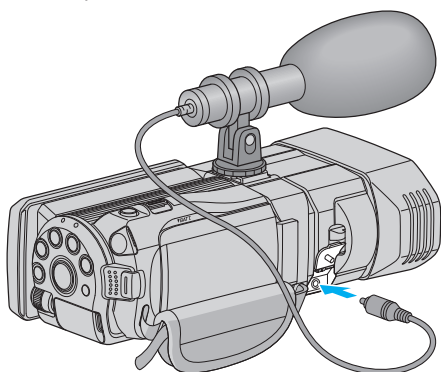

Memo :

- Do not apply too much force when attaching accessories such as an external microphone.
- The microphone level display and setting can be changed in the menu. "MIC LEVEL" (p. 111)
"MIC LEVEL SETTING" (p. 111)

Using this Unit Overseas

The shape of the power outlet varies according to countries and regions. To charge the battery pack, you need a converter plug that matches the shape of the outlet.

"Charging the Battery Pack Overseas" (p. 24)

Change the date and time display to the local time by selecting your travel destination in "AREA SETTING" of "CLOCK ADJUST".

"Setting the Clock to Local Time when Traveling" (p. 25)

When "ON" is selected in "DST SETTING" of "CLOCK ADJUST", the time is set 1 hour ahead.

"Setting Daylight Saving Time" (p. 25)

Charging the Battery Pack Overseas

The shape of the power outlet varies according to countries and regions. To charge the battery pack, you need a converter plug that matches the shape of the outlet.

A	B	BF	C	O

North America	Europe	Oceania	Middle East
United States A	Iceland C	Australia O	Israel C
Canada A	Ireland C	Guam A	Iran C
Mexico A	United Kingdom B,BF	Tahiti C	Kuwait B,C
	Italy C	Tonga O	Jordan B,BF
	Austria C	New Zealand O	
India B,C,BF	Netherlands C	Fiji O	Africa
Indonesia C	Canary Islands C		Algeria A,B,BF,C
Singapore B,BF	Greece C	Latin	Egypt B,BF,C
Sri Lanka B,C,BF	Switzerland C	Argentina O	Guinea C
Thailand A,BF,C	Sweden C	Colombia A	Kenya B,C
South Korea A,C	Spain A,C	Jamaica A	Zambia B,BF
China A,B,BF,C,O	Denmark C	Chile B,C	Tanzania B,BF
Japan A	Germany C	Haiti A	Republic of South Africa B,C,BF
Nepal C	Norway C	Panama A	
Pakistan B,C	Hungary C	Bahamas A	Mozambique C
Bangladesh C	Finland C	Puerto Rico A	Morocco C
Philippines A,BF,O	France C	Brazil A,C	
Vietnam A,C	Belgium C	Venezuela A	
Hong Kong Special	Poland B,C	Peru A,C	
Administrative Region B,BF	Portugal B,C		
Macau Special	Romania C		
Administrative Region B,C			
Malaysia B,BF,C			

Setting the Clock to Local Time when Traveling

Change the date and time display to the local time by selecting your travel destination in "AREA SETTING" of "CLOCK ADJUST".

Restore the region settings after you returned from the trip.

1 Tap "MENU".

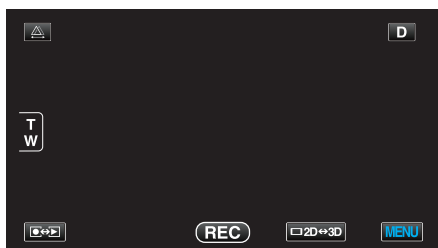

2 Tap "⚙️".



3 Tap "CLOCK ADJUST".

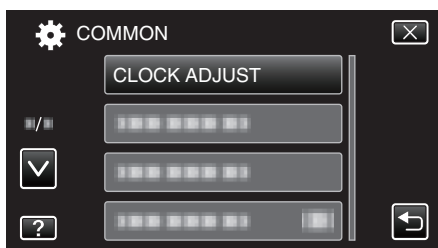

- Tap \wedge or \vee to move upward or downward for more selection.

4 Tap "AREA SETTING".

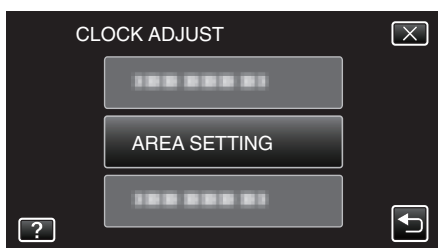

5 Select the area you are traveling to and tap "SAVE".



- The city name and time difference are displayed.
- Tap $<$ or $>$ to select the city name.

Memo :

- Setting "AREA SETTING" changes the clock time such that time difference is accounted for.

After returning to your country, re-select the region that was set initially to restore the original clock settings.

Setting Daylight Saving Time

When "ON" is selected in "DST SETTING" of "CLOCK ADJUST", the time is set 1 hour ahead.

1 Tap "MENU".

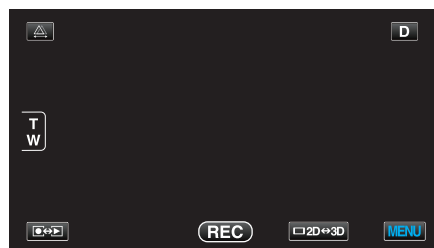

2 Tap "⚙️".

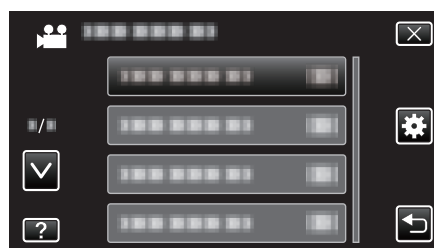

3 Tap "CLOCK ADJUST".

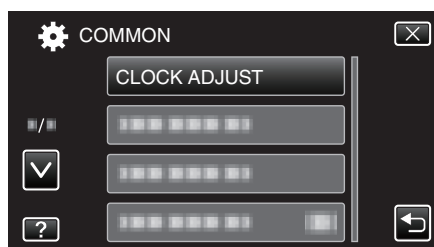

- Tap \wedge or \vee to move upward or downward for more selection.

4 Tap "DST SETTING".

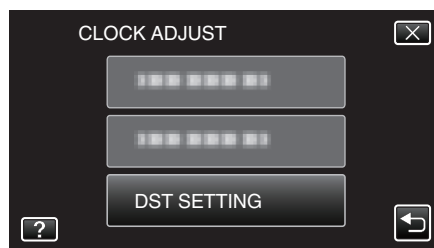

5 Tap "ON".

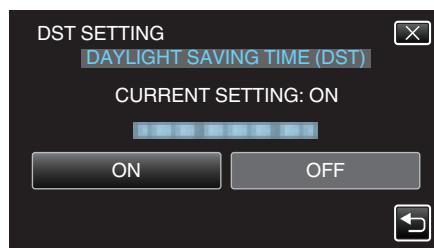

Memo :

- What is daylight saving time?
Daylight saving time is the system of setting the clock 1 hour ahead for a fixed period in summer.
It is used mainly in the Western countries.
- Restore the daylight saving time settings after you returned from the trip.

Optional Accessories

You can record for a longer time by using the optional battery pack.

Product Name	Description
Battery Pack • BN-VF815U • BN-VF823U	<ul style="list-style-type: none"> BN-VF815U is the same battery pack that comes with this unit. BN-VF823U provides a longer recording time than the provided battery pack. It can also be used as a spare battery pack.
Battery Charger • AA-VF8	<ul style="list-style-type: none"> Enables the battery pack to be charged without using this unit.
HDMI Cable • VX-HD310 • VX-HD315 • VX-HD320 • VX-HD330	<ul style="list-style-type: none"> Allows viewing in high picture quality when connected to a TV. Transmits video, audio, and control signals between devices.

Memo : _____

- For more information, consult your JVC dealer.
- For details on the provided accessories, refer to “Verifying the Accessories”.

“Verifying the Accessories” (p. 13)

Approximate Recording Time (Using Battery)

■ 3D Display on LCD Monitor

Battery Pack	Actual Recording Time		
	3D Recording MP4(MVC)	3D Recording AVCHD 3D *	3D Recording AVCHD
BN-VF815U (Supplied)	55 m	55 m	1 h
BN-VF823U	1 h 20 m	1 h 20 m	1 h 35 m

Battery Pack	Continuous Recording Time		
	3D Recording MP4(MVC)	3D Recording AVCHD 3D *	3D Recording AVCHD
BN-VF815U (Supplied)	1 h 45 m	1 h 45 m	2 h
BN-VF823U	2 h 40 m	2 h 40 m	3 h 5 m

■ 2D Display on LCD Monitor

Battery Pack	Actual Recording Time			
	3D Recording MP4(MVC)	3D Recording AVCHD 3D *	3D Recording AVCHD	2D Recording
BN-VF815U (Supplied)	55 m	55 m	1 h 5 m	1 h 20 m
BN-VF823U	1 h 25 m	1 h 25 m	1 h 40 m	1 h 55 m

Battery Pack	Continuous Recording Time			Continuous Recording Time
	3D Recording MP4(MVC)	3D Recording AVCHD 3D *	3D Recording AVCHD	
BN-VF815U (Supplied)	1 h 50 m	1 h 50 m	2 h 10 m	2 h 35 m
BN-VF823U	2 h 45 m	2 h 45 m	3 h 15 m	3 h 50 m

- The above are values when “MONITOR BRIGHTNESS” is set to “STANDARD”.
- The actual recording time may be shorter if zooming is used or if recording is stopped repeatedly. (It is recommended to prepare battery packs ready for three times the expected recording time.)
- When the battery life is reached, the recording time becomes shorter even if the battery pack is fully charged. (Replace the battery pack with a new one.)

* For customers who completed the firmware update

Taking Videos in 3D Mode

You can record 3D images by pressing the 3D button to set to the 3D mode. During 3D mode, "3D" is displayed on the LCD monitor.

- 1 Open the lens cover.

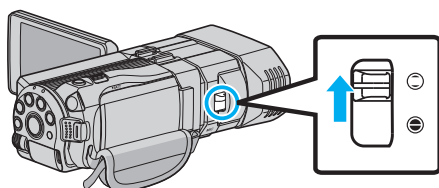

- 2 Open the LCD monitor and select the video mode.

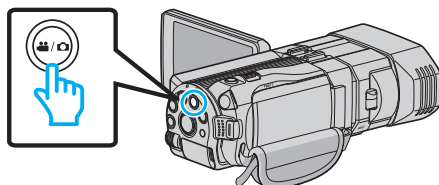

- The video mode icon  appears.

- 3 Check if the recording mode is **i.A.** Intelligent Auto.

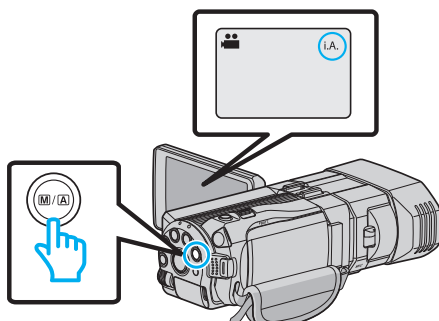

- If the mode is **M** Manual, press the **M/A** button to switch to **i.A.** Intelligent Auto. The mode changes between Intelligent Auto and Manual with every press.

- 4 Press the 3D button to set to the 3D mode.

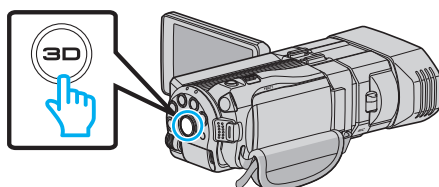

- During 3D mode, "3D" is displayed on the LCD monitor.
- 3D images may be recorded when the 3D button lights up.

- 5 Start recording.

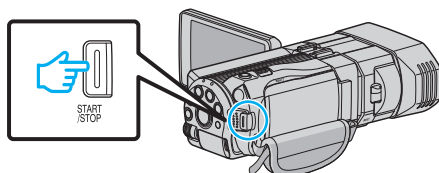

- Press again to stop.

Memo :

- To record 3D images, refer also to "Precautions on Recording and Playing Back 3D Images" (p. 11).
- If the left and right images of an object close to the camera do not appear to be in alignment, or the 3D effect of a distant object is weak, adjust the parallax. "Adjusting Parallax During Recording" (p. 35)
- When "PARALLAX ADJUSTMENT" is assigned to the ADJ button, parallax can be adjusted manually using the ADJ button and control dial. "Using the Control Dial for Recording" (p. 44)
- You can change the display on the LCD monitor between 3D and 2D during recording by tapping on the 3D/2D icon. The image will be recorded

in 3D even if the display on the LCD monitor is set to 2D. To record 2D images, press the 3D button to switch to the 2D mode before recording.

"Taking Videos in Intelligent Auto Mode" (p. 30)

- If the microphone level is frequently displayed in red, lower the setting in "MIC LEVEL SETTING" such that the display turns green so that more realistic audio sounds can be recorded.

"MIC LEVEL SETTING" (p. 111)

3D recording formats

There are 2 types of 3D recording formats, namely "AVCHD" and "MP4(MVC)".

By default, "3D VIDEO REC FORMAT" is set to "AVCHD". "Changing the Setting" (p. 107)

■ AVCHD

Set to this recording format for higher compatibility.

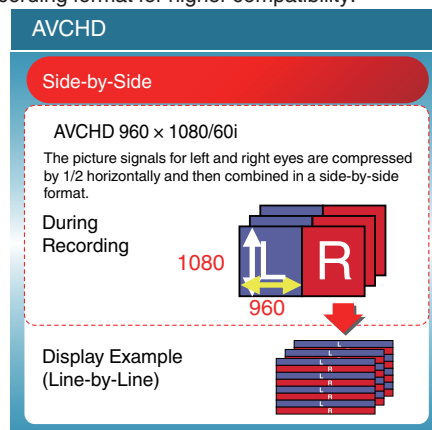

■ MP4(MVC)

Set to this recording format for higher video quality.

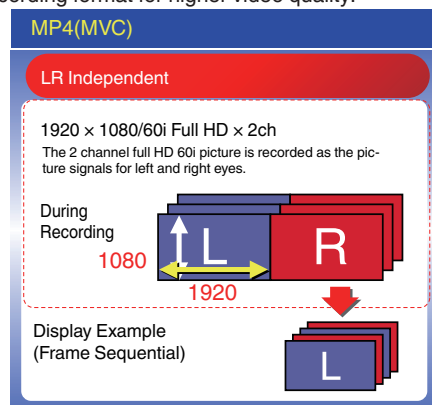

Memo :

- Videos recorded in "MP4(MVC)" format are saved in full high definition and can only be played back on this unit.
- To record 3D images to a disc with a Blu-ray recorder or a computer, set to "AVCHD".
- By dubbing videos recorded in "AVCHD" format to a Blu-ray recorder, the left and right images will be recorded or played back separately, allowing 3D images to be enjoyed when connected to a 3D compatible TV.
- Videos recorded in "MP4(MVC)" and "AVCHD" are displayed on the playback index screen separately.

3D Recording Formats (For customers who completed the firmware update)

There are 3 types of 3D recording formats, namely "AVCHD 3D", "AVCHD" and "MP4(MVC)".

After the firmware update, "3D VIDEO REC FORMAT" will be set to "AVCHD 3D".

"Changing the Setting" (p. 107)

■ AVCHD 3D

A method to record in high picture quality while maintaining the compatibility. (Videos can be saved to a disc by using the AVCHD 3D compatible Blu-ray recorder. Please check "Copying Your Files" for details).

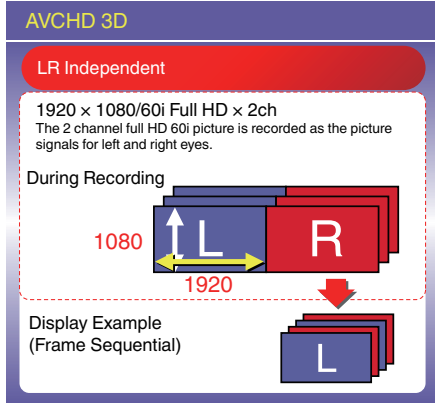

■ AVCHD

Set to this recording format for higher compatibility. (Videos can be saved to a disc by using the AVCHD or AVCHD 3D compatible Blu-ray recorder. Please check "Copying Your Files" for details).

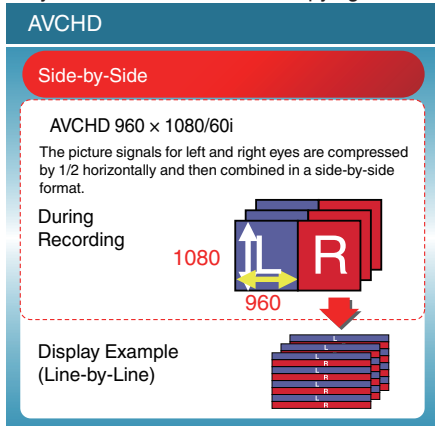

■ MP4(MVC)

A method to record videos that are immersive and with high-resolution.

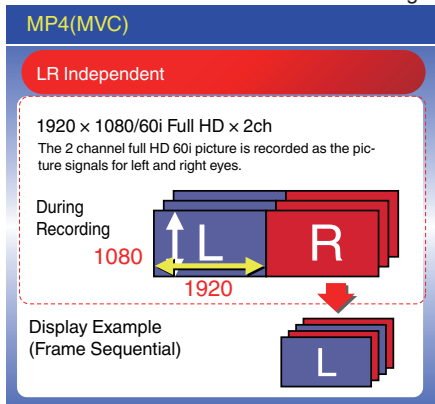

Memo :

- Videos recorded in "MP4(MVC)" format are saved in full high definition and can only be played back on this unit.
- To record 3D images to a disc by using a Blu-ray recorder or a computer, set to "AVCHD 3D" or "AVCHD".
- By dubbing videos recorded in "AVCHD" format to a Blu-ray recorder, the left and right images will be recorded or played back separately, allowing 3D images to be enjoyed when connected to a 3D compatible TV.
- Videos recorded in "MP4(MVC)", "AVCHD 3D" and "AVCHD" are displayed on the playback index screen separately.

Taking Still Images in 3D Mode

You can record 3D images by pressing the 3D button to set to the 3D mode. During 3D mode, "3D" is displayed on the LCD monitor.

- 1 Open the lens cover.

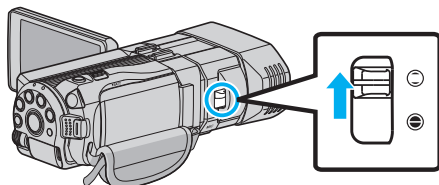

- 2 Open the LCD monitor and select the still image mode.

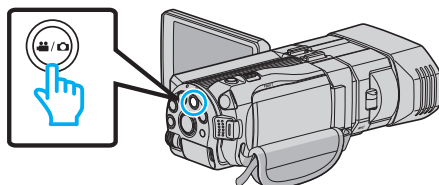

- The still image icon  appears.

- 3 Press the 3D button to set to the 3D mode.

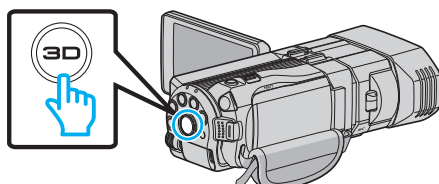

- During 3D mode, "3D" is displayed on the LCD monitor.
- 3D images may be recorded when the 3D button lights up.

- 4 Set the focus on the subject.

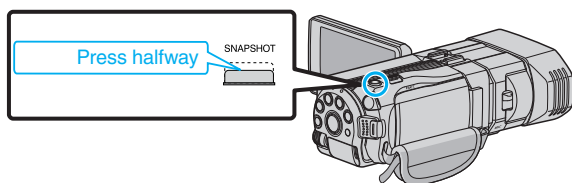

- When focused, the focus icon lights up in green.

- 5 Take a still image.

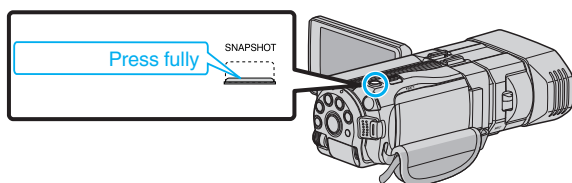

- PHOTO lights up when a still image is being captured.

Memo :

- When 3D recording is performed, still images will be saved in both 3D and 2D formats.
 - 3D still images are saved as MP files (*.mpo).
 - 3D still images can only be printed by the 3D printing service.
When printing by other than 3D printing service, use the 2D still images (shot simultaneously when 3D still images are shot) for printing.
 - Use the provided software (Everio Media Browser 3D) to transfer 3D still images to a computer for playback.
- "Copying to Windows PC" (☞ p. 94)
- To record 3D images, refer also to "Precautions on Recording and Playing Back 3D Images" (☞ p. 11).
 - If the left and right images of an object close to the camera do not appear to be in alignment, or the 3D effect of a distant object is weak, adjust the parallax.
- "Adjusting Parallax During Recording" (☞ p. 35)
- When "PARALLAX ADJUSTMENT" is assigned to the ADJ button, parallax can be adjusted manually using the ADJ button and control dial.
- "Using the Control Dial for Recording" (☞ p. 44)

Taking Videos in Intelligent Auto Mode

You can record without worrying about the setting details by using the Intelligent Auto mode.

- Before recording an important scene, it is recommended to conduct a trial recording.

1 Open the lens cover.

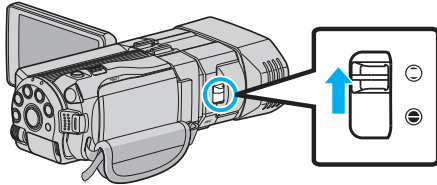

2 Open the LCD monitor and select the video mode.

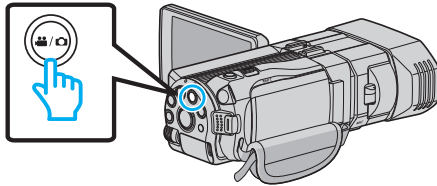

- The video mode icon  appears.

3 Check if the recording mode is **i.A.** Intelligent Auto.

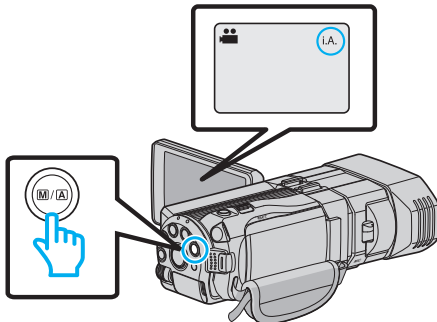

- If the mode is **M** Manual, press the **M/A** button to switch to **i.A.** Intelligent Auto. The mode changes between Intelligent Auto and Manual with every press.

4 Start recording.

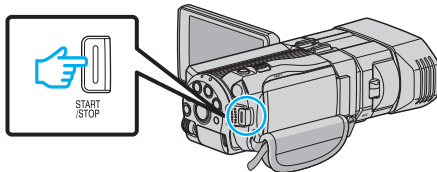

- Press again to stop.

Indications During Video Recording

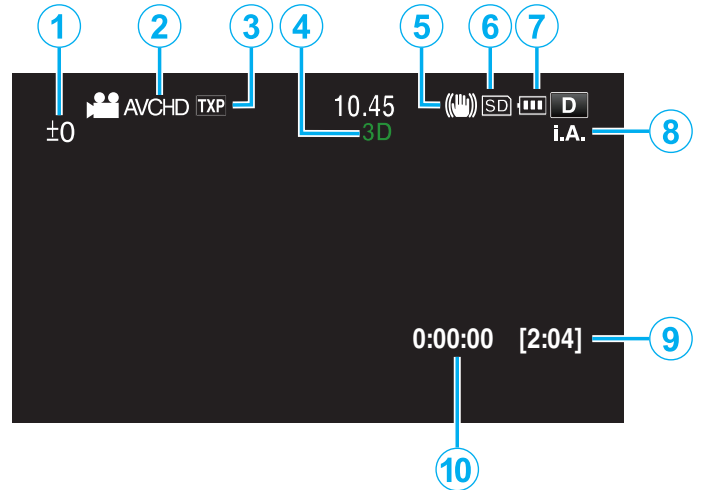

	Display Icon	Description
①	Parallax Adjustment Value (3D mode only)	Displays the adjusted value when performing parallax adjustment manually. "Adjusting Parallax During Recording" (☞ p. 35)
②	3D VIDEO REC FORMAT (3D mode only)	Displays the recording format for 3D video recording.
③	Video Quality	Displays the icon of the "VIDEO QUALITY" setting selected in the recording menu. "VIDEO QUALITY" (☞ p. 108)
④	3D/2D Mode	Displays the current recording mode of 3D or 2D. "3D" is displayed during 3D recording, while "2D" is displayed during 2D recording.
⑤	Image Stabilizer	Displays the icon of the "DIS" setting selected in the recording menu. "Reducing Camera Shake" (☞ p. 45)
⑥	Recording Media	Displays the icon of the media where videos are recorded to. You can change the setting with "REC MEDIA FOR VIDEO". "REC MEDIA FOR VIDEO" (☞ p. 125)
⑦	Battery Indicator	Displays the approximate remaining battery power. Details of the battery power can be displayed by pressing the INFO button. "Remaining Recording Time/Battery Power" (☞ p. 50)
⑧	Recording Mode	Displays the current recording mode of i.A. (Intelligent Auto) or M (Manual). The mode changes with every press of the i.AUTO button.
⑨	Remaining Recording Time	Displays the remaining time for video recording.
⑩	Scene Counter (Recorded Time)	Displays the elapsed time of the video that is currently being recorded.

■ Scenes of Intelligent Auto

Display Icon	Description
	Captures one's skin beautifully.
	Allows people to be captured naturally.
	Focuses at a far distance and captures a sharp image with vivid colors.
	Records with minimal noise in the overall image.
	Allows night scenes to be captured accurately with minimal noise in the overall image.
	Prevents colors from fading even when recording in a bright environment.
	Records while focusing on a near object.
	Reproduces the green color of trees vividly.
	Reproduces the colors of sunset naturally.
	Adjusts settings so that the subject does not appear too dark due to backlight.
	Allows people to be captured naturally with minimal noise in the overall image.
	Records while focusing on a near object even in a dark environment.

Memo :

- Scenes can be detected according to the shooting conditions and automatically adjusted in Intelligent Auto mode.
- Some functions may not work properly depending on the shooting conditions.

Operation Buttons for Video Recording

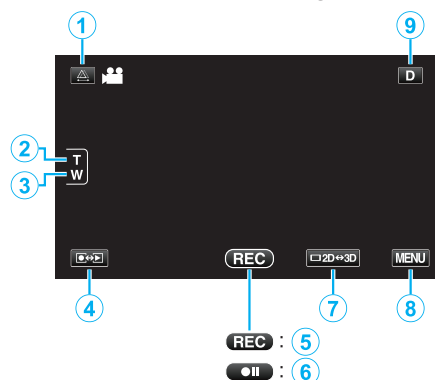

	Operation Button	Description
①	Parallax Adjustment	Adjusts the 3D effect when 3D images are displayed on the LCD monitor. "Adjusting Parallax During Recording" (☞ p. 35)
② / ③	T/W Zoom	Allows the same functions as the zoom lever to be performed. Camera shake that often occurs when using the zoom lever can be minimized. "Zooming" (☞ p. 32)
④	Recording/ Playback Mode	Switches between recording and playback modes.
⑤ / ⑥	Recording Start REC Record-Standby II	Functions as the START/STOP button.
⑦	LCD Monitor 3D/2D Display	Switches the display on the LCD monitor between 3D and 2D. The image will be recorded in 3D even if the display on the LCD monitor is set to 2D.
⑧	MENU	Displays the various menus of video recording. "Operating the Menu" (☞ p. 102)
⑨	Display Button D	Some displays disappear after approximately 3 seconds. Use the D button to change the displays as shown below. <ul style="list-style-type: none"> • Tap D button Displays appear for approximately 3 seconds with every tap. • Tap and hold D button Displays are fixed such that they do not disappear. After setting, the display button changes from D to D?. Tap D? to release the displays.

Useful Settings for Recording

- When “AUTO POWER OFF” is set to “ON”, this unit turns itself off automatically to conserve power when it is not operated for 5 minutes. (only when using the battery pack)

“AUTO POWER OFF” (☞ p. 127)

- When “TOUCH PRIORITY AE/AF” is set to “FACE TRACKING”, this unit detects faces and automatically adjusts its brightness and focus to record the faces more clearly.

“Capturing Subjects Clearly (TOUCH PRIORITY AE/AF)” (☞ p. 45)

Caution :

- Do not expose the lens to direct sunlight.
- Do not use this unit in the rain, snow, or places with high humidity like the bathroom.
- Do not use this unit in places subject to excessive humidity or dust, as well as places exposed to steam or smoke directly.
- Do not remove the battery pack, AC adapter, or SD card when the access lamp is lighted. The recorded data may become unreadable.

“Playing a Video with Defective Management Information” (☞ p. 55)

- Make a backup of important recorded data. It is recommended to copy your important recorded data to a DVD or other recording media for storage. JVC will not be responsible for any lost data.

Memo :

- Before recording an important scene, it is recommended to conduct a trial recording.
- Check the remaining recording time in the media before you start shooting. If there is not enough space, move (copy) the data to a computer or disc.
- Do not forget to make copies after recording!
- Recording stops automatically as it cannot be performed for 12 or more consecutive hours according to specifications. (It may take some time to resume recording.)
- For long recordings, the file is split into two or more files if the size exceeds 4 GB.
- You can connect this unit to the AC adapter to record for long hours indoors.
- The maximum number of files that can be recorded to the same media is 9999 for MP4 video and still image files respectively.

Zooming

The angle of view can be adjusted using zoom.

- Use the W end (wide angle end) to shoot a wider field of view.
- Use the T end (telephoto end) to magnify the subject for shooting.

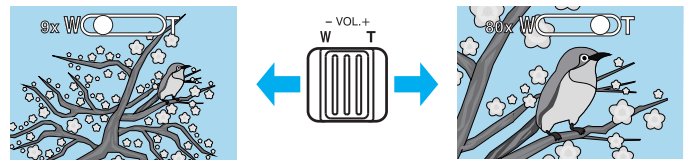

Wide Angle

Telephoto

- The following zoom options are available:
 - Optical Zoom (1 – 5x) *During 3D recording
 - Optical Zoom (1 – 10x) *During 2D recording
 - Digital Zoom (11 – 200x) *During 2D recording
- You can also use the zoom (T/W) button on the touch screen to zoom.

Zoom Button (T/W)

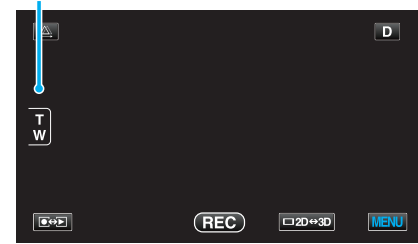

Memo :

- When digital zoom is used, the image becomes grainy as it is digitally enlarged.
- The zoom ratio range can be changed.

“ZOOM (2D mode only)” (☞ p. 109)

Taking Still Images in Intelligent Auto Mode

You can record without worrying about the setting details by using the Intelligent Auto mode.

- 1 Open the lens cover.

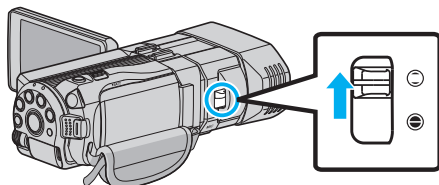

- 2 Open the LCD monitor and select the still image mode.

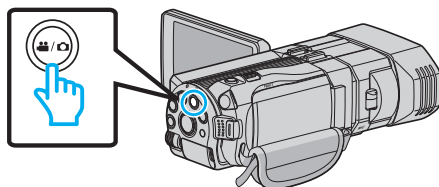

- The still image icon  appears.

- 3 Check if the recording mode is **i.A.** Intelligent Auto.

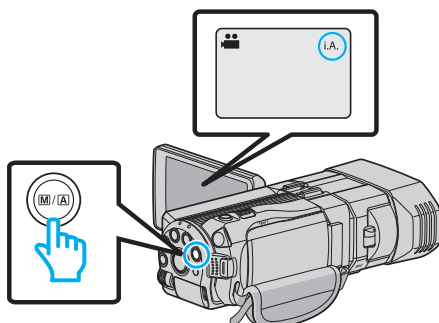

- If the mode is **M** Manual, press the **M/A** button to switch to **i.A.** Intelligent Auto. The mode changes between Intelligent Auto and Manual with every press.

- 4 Set the focus on the subject.

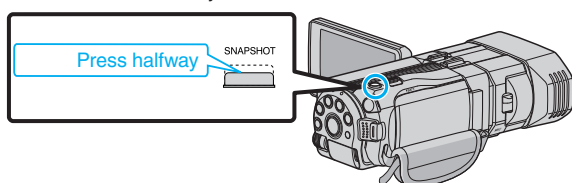

- When focused, the focus icon lights up in green.

- 5 Take a still image.

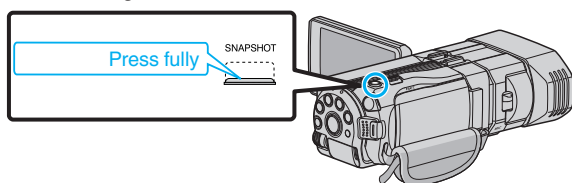

- PHOTO lights up when a still image is being captured.

Indications During Still Image Recording

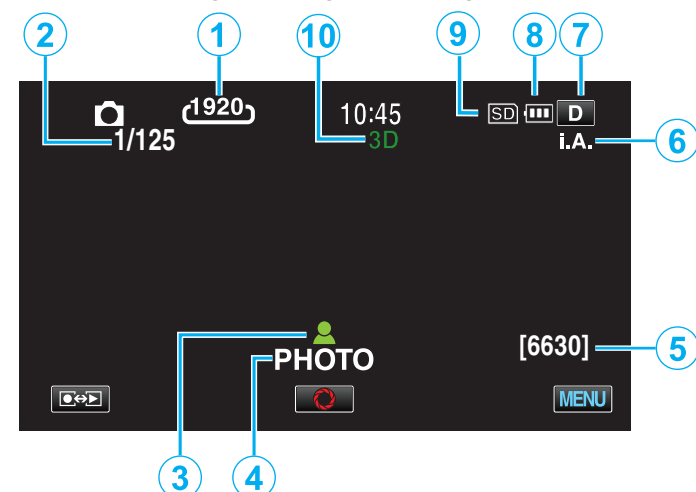

	Display Icon	Description
①	Image Size	Displays the icon of the image size. <ul style="list-style-type: none"> • The size of still images can be changed. "IMAGE SIZE" (see p. 118)
②	Shutter Speed	Displays the shutter speed.
③	Focus	Lights up in green when focused.
④	Recording in Progress	Appears when a still image is being captured.
⑤	Remaining Number of Shots	Displays the remaining number of shots for still image recording.
⑥	Recording Mode	Press the i.AUTO button to switch the recording mode between i.A. (Intelligent Auto) and M (Manual).
⑦	Display Button D	Some displays disappear after approximately 3 seconds. Use the D button to change the displays as shown below. <ul style="list-style-type: none"> • Tap D button Displays appear for approximately 3 seconds with every tap. • Tap and hold D button Displays are fixed such that they do not disappear. After setting, the display button changes from D to D_L. Tap D_L to release the displays.
⑧	Battery Indicator	Displays the approximate remaining battery power. Details of the battery power can be displayed by pressing the INFO button. "Remaining Recording Time/Battery Power" (see p. 50)
⑨	Recording Media	Displays the icon of the media where still images are recorded to. The recording media can be changed. "REC MEDIA FOR IMAGE" (see p. 126)
⑩	3D/2D Mode	Displays the current recording mode of 3D or 2D. "3D" is displayed during 3D recording, while "2D" is displayed during 2D recording.

Operation Buttons for Still Image Recording

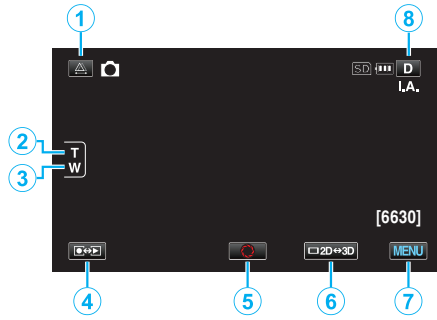

	Operation Button	Description
①	Parallax Adjustment	Adjusts the 3D effect when 3D images are displayed on the LCD monitor. “Adjusting Parallax During Recording” (☞ p. 35)
② / ③	T/W Zoom	Allows the same functions as the zoom lever to be performed. Camera shake that often occurs when using the zoom lever can be minimized. “Zooming” (☞ p. 32)
④	Recording/ Playback Mode	Switches between recording and playback modes.
⑤	Snapshot 	Functions as the SNAPSHOT button. However, focus cannot be set by pressing halfway.
⑥	LCD Monitor 3D/2D Display	Switches the display on the LCD monitor between 3D and 2D. The image will be recorded in 3D even if the display on the LCD monitor is set to 2D.
⑦	MENU	Displays the various menus of still image recording. “Operating the Menu” (☞ p. 102)
⑧	Display Button D	Some displays disappear after approximately 3 seconds. Use the D button to change the displays as shown below. <ul style="list-style-type: none"> • Tap D button Displays appear for approximately 3 seconds with every tap. • Tap and hold D button Displays are fixed such that they do not disappear. After setting, the display button changes from D to D_L. Tap D_L to release the displays.

Useful Settings for Recording

- When “QUICK RESTART” is set to “ON”, this unit turns on immediately if you open the LCD monitor within 5 minutes after the power is turned off by closing the monitor.

“QUICK RESTART” (☞ p. 127)

- When “AUTO POWER OFF” is set to “ON”, this unit turns itself off automatically to conserve power when it is not operated for 5 minutes. (only when using the battery pack)

“AUTO POWER OFF” (☞ p. 127)

- When “TOUCH PRIORITY AE/AF” is set to “FACE TRACKING”, this unit detects faces and automatically adjusts its brightness and focus to record the faces more clearly.

“Capturing Subjects Clearly (TOUCH PRIORITY AE/AF)” (☞ p. 45)

- The image resolution can be changed.

“IMAGE SIZE” (☞ p. 118)

Caution :

- Do not expose the lens to direct sunlight.
- Do not use this unit in the rain, snow, or places with high humidity like the bathroom.
- Do not use this unit in places subject to excessive humidity or dust, as well as places exposed to steam or smoke directly.
- Do not remove the battery pack, AC adapter, or SD card when the access lamp is lighted. The recorded data may become unreadable.

Memo :

- Before recording an important scene, it is recommended to conduct a trial recording.
- The digital image stabilizer does not work when recording still images.

Zooming

The angle of view can be adjusted using zoom.

- Use the W end (wide angle end) to shoot a wider field of view.
- Use the T end (telephoto end) to magnify the subject for shooting.

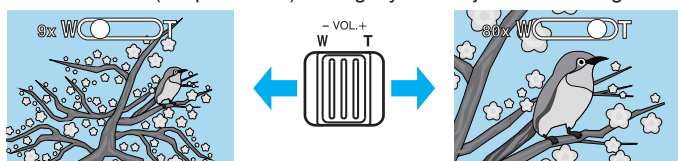

Wide Angle

Telephoto

- The following zoom options are available:
 - Optical Zoom (1 – 5x) *During 3D recording
 - Optical Zoom (1 – 10x) *During 2D recording
- You can also use the zoom (T/W) button on the touch screen to zoom.

Zoom Button (T/W)

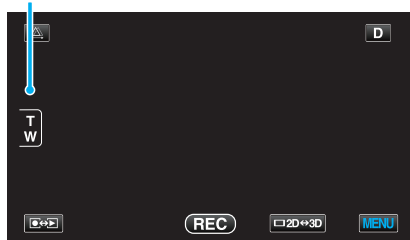

Memo :

- Only optical zoom is available in the still image recording mode.

Adjusting Parallax During Recording

When recording 3D images, parallax is automatically adjusted. If the left and right images of an object close to the camera do not appear to be in alignment, or the 3D effect of a distant object is weak, you can make adjustments by bringing the left and right images closer to each other.

- Parallax can only be adjusted when 3D images are displayed on the unit's LCD monitor.

“3D VIDEO REC FORMAT (3D mode only)” (p. 107)

- 1 Tap .



- 2 Tap “MANUAL”.

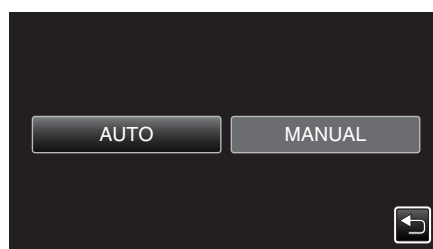

- The parallax adjustment screen appears.
- To set parallax adjustment to auto (default), tap “AUTO”.

- 3 Adjust the parallax.

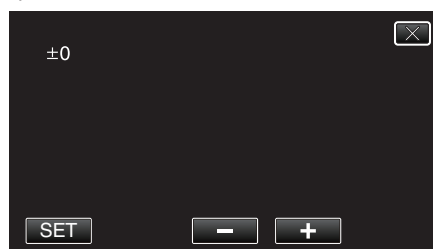

- To increase the amount of correction, tap “+”. Doing so increases the value of the parallax display.
- To reduce the amount of correction, tap “-”. Doing so decreases the value of the parallax display.

- 4 Tap “SET” to confirm.

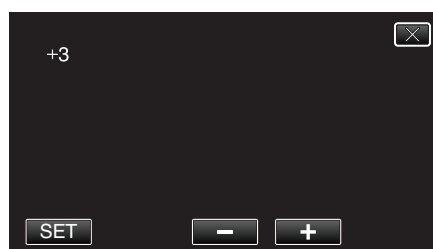

Caution :

- Too much parallax may cause the 3D effect to be lost.
- If you see double images even after parallax adjustment, set the display on the LCD monitor to 2D immediately.

Memo :

- While this unit is equipped with the function to adjust parallax automatically, it may not work properly for the following subjects.
 - Subjects beyond the recommended shooting distance (especially subjects that are extremely close to the camera)
 - Numerous subjects of the similar shape arrayed in a line, such as the windows of a building
 - Straight subjects such as electric wires
 In these cases, adjust the parallax manually.

Recording

- When the power of this unit is turned off or the mode is switched to playback after parallax is manually adjusted, the "PARALLAX ADJUSTMENT" setting returns to "AUTO".

Manual Recording

You can adjust settings, such as brightness and shutter speed, by using the manual mode.

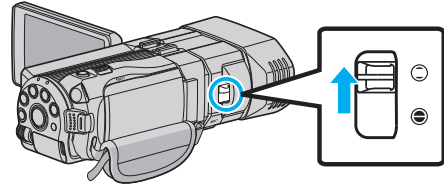

Manual recording can be set for both video and still image modes.

- 1 Open the lens cover.

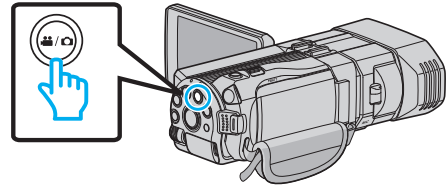

- 2 Open the LCD monitor and select the video or still image mode.



- The video  or still image  icon appears.

- 3 Select the Manual recording mode.

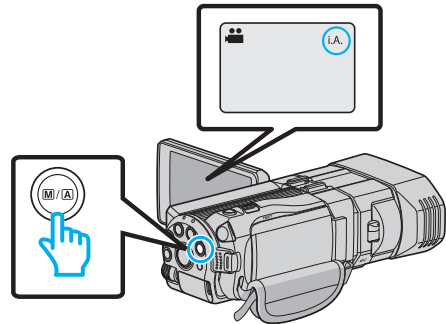

- If the mode is **i.A.** Intelligent Auto, press the **M/A** button to switch to **M** Manual. The mode changes between Intelligent Auto and Manual with every press.

- 4 Tap "MENU".

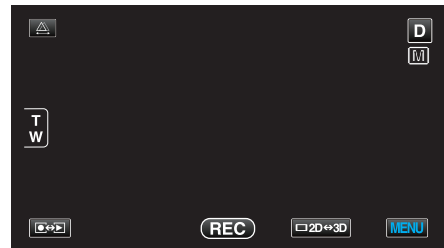

- 5 Tap the item to set manually.

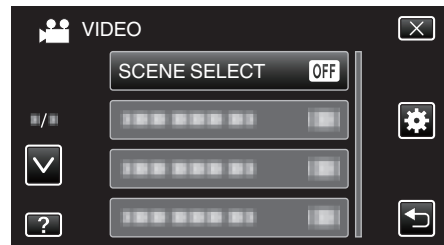

- For details on the various manual settings, refer to "Manual Recording Menu".

Memo :

- The manual settings are displayed only in the manual recording mode.

Manual Recording Menu

The following items can be set.

Name	Description
SCENE SELECT	<ul style="list-style-type: none"> Recordings that suit the shooting conditions can be performed easily. “Scene Selection” (☞ p. 37)
FOCUS	<ul style="list-style-type: none"> Use manual focus if the subject is not focused automatically. “Adjusting Focus Manually” (☞ p. 38)
FOCUS ASSIST	<ul style="list-style-type: none"> Focused subject is outlined in color for more precise focus. “Using Focus Assist” (☞ p. 39)
FOCUS ASSIST COLOR	<ul style="list-style-type: none"> Sets the color of the outline of a focused object when Focus Assist is used. “FOCUS ASSIST COLOR” (☞ p. 115)
BRIGHTNESS ADJUST	<ul style="list-style-type: none"> Overall brightness on the screen can be adjusted. Use this when recording in a dark or bright location. “Adjusting Brightness” (☞ p. 39)
SHUTTER SPEED	<ul style="list-style-type: none"> Shutter speed can be adjusted. Use this when shooting a fast-moving subject or to emphasize the subject's movement. “Setting Shutter Speed” (☞ p. 40)
APERTURE PRIORITY	<ul style="list-style-type: none"> You can adjust the aperture to capture an image with only the subject in focus while blurring the surroundings. “Setting Aperture” (☞ p. 40)
WHITE BALANCE	<ul style="list-style-type: none"> Overall color on the screen can be adjusted. Use this when the color on the screen appears differently from the actual color. “Setting White Balance” (☞ p. 41)
BACKLIGHT COMP.	<ul style="list-style-type: none"> Corrects the image when the subject appears dark due to backlight. Use this when shooting against the light. “Setting Backlight Compensation” (☞ p. 42)
TELE MACRO	<ul style="list-style-type: none"> Use this to take close-up (macro) shots of the subject. “Taking Close-up Shots” (☞ p. 42) *Displayed only in the 2D recording mode.

Scene Selection

Common scenes that are often encountered can be recorded with the most suitable settings.

1 Tap “MENU”.

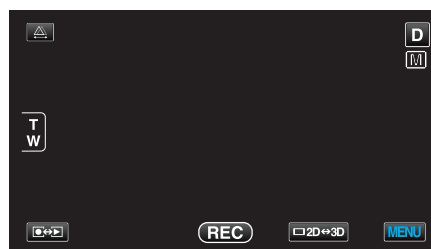

2 Tap “SCENE SELECT”.

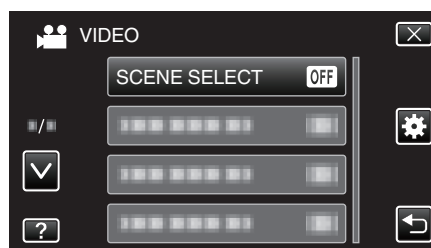

- Tap \wedge or \vee to move upward or downward for more selection.
- Tap \times to exit the menu.
- Tap \curvearrowright to return to the previous screen.

3 Tap the appropriate scene.

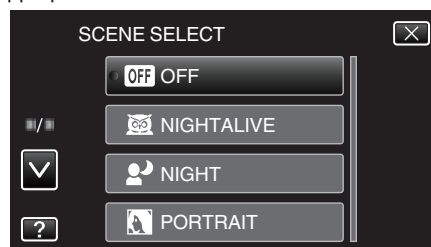

- After setting, the selected scene is immediately put on view.
- Tap “OFF” to cancel the selection.
- Tap \wedge or \vee or flick on the list to move upward or downward for more scene selection.
- Tap \times to exit the menu.

*The image is only an impression.

Setting	Effect
NIGHTLIVE	Increases gain and brightens the scene automatically using a slow shutter when the surrounding is dark. To prevent camera shake, use a tripod. OFF ON
NIGHT	Captures night scenes naturally. OFF ON
PORTRAIT	Blurs the background to bring out the people in the picture. OFF ON
SPORTS	Captures fast-moving subjects clearly in every single frame. OFF ON
SNOW	Prevents the subject from appearing too dark when recording snow scenes on a sunny day. OFF ON
SPOTLIGHT	Prevents the human subject from appearing too bright under light. OFF ON

Adjusting Focus Manually

Set this when the focus is not clear in Intelligent Auto or when manual focusing is desired.

1 Tap "MENU".



2 Tap "FOCUS".

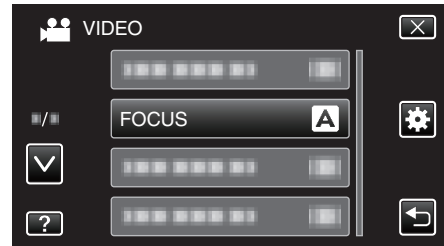

- Tap \wedge or \vee to move upward or downward for more selection.
- Tap \times to exit the menu.
- Tap \curvearrowright to return to the previous screen.

3 Tap "MANUAL".

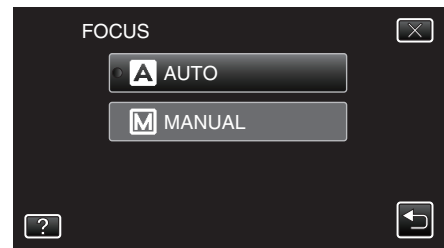

4 Adjust the focus.

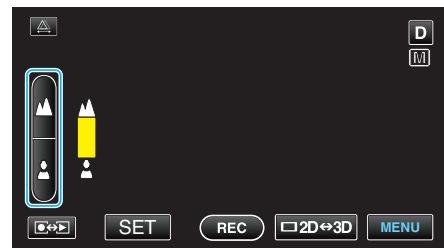

- Tap \blacktriangle to focus on a distant subject.
- Tap \blacktriangle to focus on a near subject.

5 Tap "SET" to confirm.

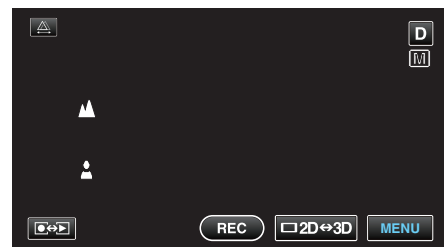

- When focus is confirmed, the focusing frame disappears and \blacktriangle and \blacktriangle are displayed. (The icons may appear blinking.)

Memo :

- A subject that is focused at the telephoto (T) end remains in focus when it is zoomed out to the wide angle (W) end.
- Focus cannot be achieved on a distant or near object beyond limit. \wedge or \vee will appear blinking.
- You can also use the control dial to adjust the focus.

"Using the Control Dial for Recording" (p. 44)

Using Focus Assist

Focused subject is outlined in color for more precise focus.

1 Tap "MENU".

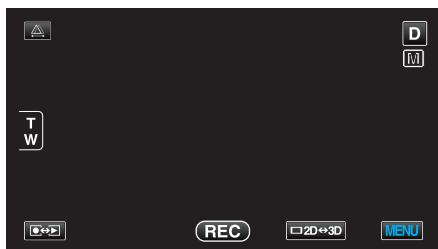

2 Tap "FOCUS ASSIST".

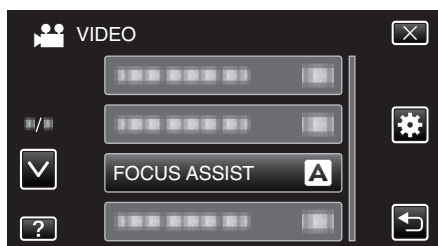

- Tap \wedge or \vee to move upward or downward for more selection.
- Tap \times to exit the menu.
- Tap \curvearrowright to return to the previous screen.

3 Adjust the focus.

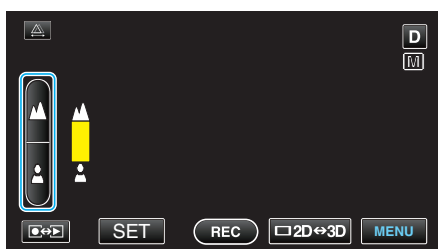

- Tap \blacktriangle to focus on a distant subject.
- Tap \blacktriangle to focus on a near subject.

4 Tap "SET" to confirm.

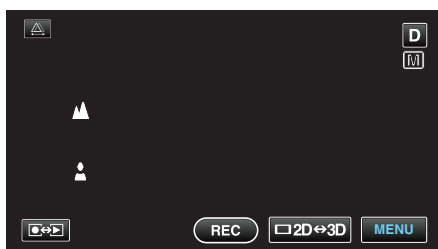

Memo :

- The image becomes black and white while the outline of the focused object is displayed in the selected color. Change outline color if it becomes difficult to see.

"FOCUS ASSIST COLOR" (p. 115)

Adjusting Brightness

You can adjust the brightness to your preferred level.

1 Tap "MENU".

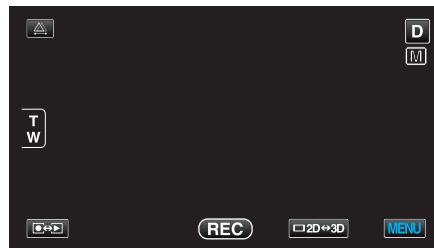

2 Tap "BRIGHTNESS ADJUST".

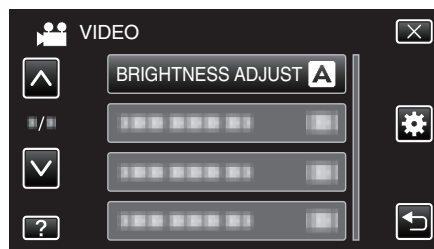

- Tap \wedge or \vee to move upward or downward for more selection.
- Tap \times to exit the menu.
- Tap \curvearrowright to return to the previous screen.

3 Tap "MANUAL".

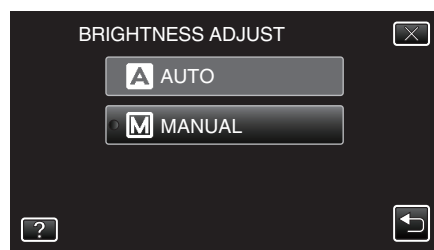

4 Adjust the brightness value.



- Compensation range during video recording: -6 to +6
- Compensation range during still image recording: -2.0 to +2.0
- Tap \wedge to increase the brightness.
- Tap \vee to decrease the brightness.

5 Tap "SET" to confirm.

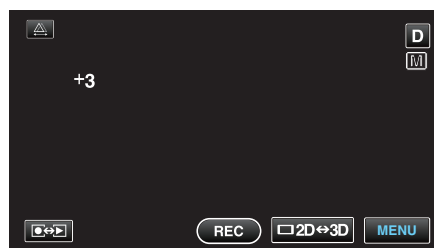

Memo :

- Settings can be adjusted separately for videos and still images.

Setting Shutter Speed

You can set the shutter speed to suit the type of subject.

1 Tap "MENU".



2 Tap "SHUTTER SPEED".

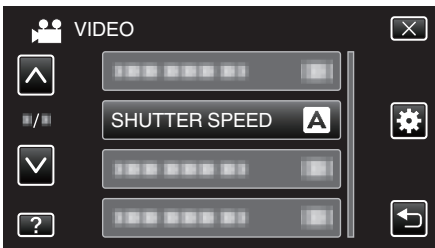

- Tap \wedge or \vee to move upward or downward for more selection.
- Tap \times to exit the menu.
- Tap \curvearrowright to return to the previous screen.

3 Tap "MANUAL".

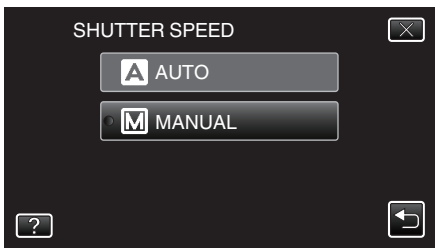

4 Adjust the shutter speed.

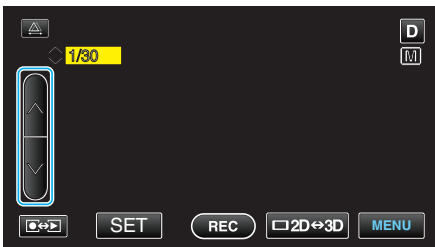

- Shutter speed can be set from 1/2 to 1/4000. (Up to 1/500 for still image.)
- Tap \wedge to increase the shutter speed.
- Tap \vee to decrease the shutter speed.

5 Tap "SET" to confirm.

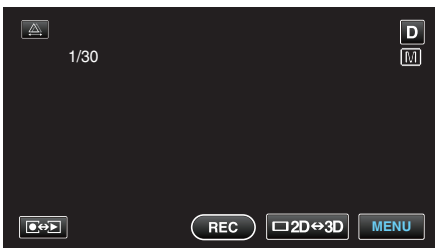

- After confirmation, the display for adjusting shutter speed disappears.

Memo :

- Settings can be adjusted separately for videos and still images.
- While fast-moving subjects can be captured clearly by increasing "SHUTTER SPEED", the screen appears darker. When recording in dark places such as indoors, check the brightness of the LCD monitor and set "SHUTTER SPEED" accordingly.

Setting Aperture

You can adjust the aperture to capture an image with only the subject in focus.

1 Tap "MENU".

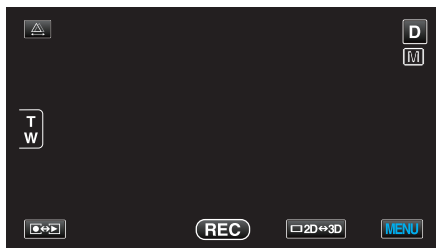

2 Tap "APERTURE PRIORITY".

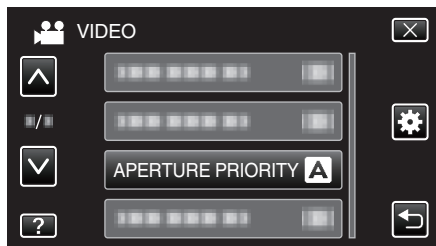

- Tap \wedge or \vee to move upward or downward for more selection.
- Tap \times to exit the menu.
- Tap \curvearrowright to return to the previous screen.

3 Tap "MANUAL".

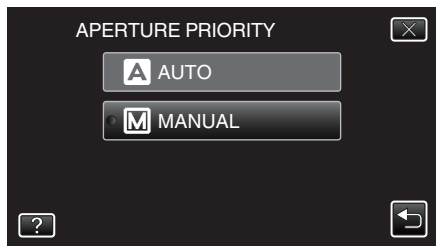

4 Adjust the aperture.



- Aperture can be set from F1.2 to F5.6.
- If you want the background to be in focus as well (larger aperture value), tap \wedge .
- If you want the background to appear blurry (smaller aperture value), tap \vee .

5 Tap "SET" to confirm.

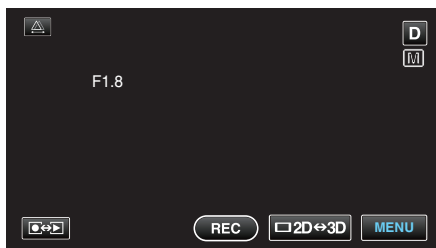

- After confirmation, the display for adjusting aperture disappears.

Memo :

- Settings can be adjusted separately for videos and still images.
- When zoomed to the telephoto end, setting the aperture to the minimum value (F1.2) does not stop it down all the way. In this case, the aperture value is set according to the zoom and indicated in yellow. Set the zoom to the wide angle end to enable the aperture to be stopped down all the way.

- The larger the aperture value, the darker the subject appears.

Setting White Balance

You can set the color tone to suit the light source.

- 1 Tap "MENU".

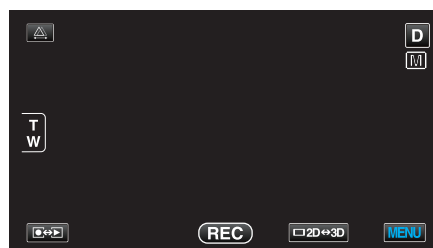

- 2 Tap "WHITE BALANCE".

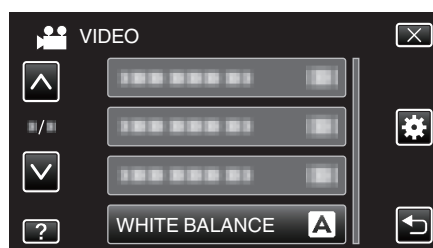

- Tap \wedge or \vee to move upward or downward for more selection.
- Tap X to exit the menu.
- Tap \curvearrowright to return to the previous screen.

- 3 Tap the appropriate shooting environment.

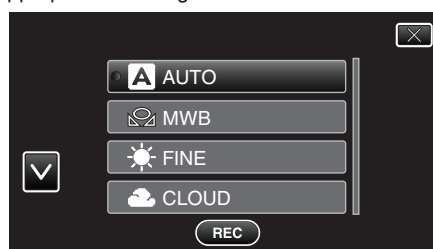

- Tap \wedge or \vee to move upward or downward to select.

Setting	Details
AUTO	Adjusts automatically to the natural colors.
MWB	Use this when the problem of unnatural colors is not resolved.
FINE	Set this when shooting outdoors on a sunny day.
CLOUD	Set this when shooting on a cloudy day or inside a shade.
HALOGEN	Set this when shooting under illumination such as a video light.
MARINE:BLUE	Set this when shooting the sea at deep water area (water appears blue).
MARINE:GREEN	Set this when shooting the sea at shallow water area (water appears green).

Using MWB

- 1 Hold a sheet of plain white paper in front of the lens so that the white paper fills the screen.
- 2 Tap "MWB" and keep touching while the icon appears and blinks.
- 3 Release your touch after the menu disappears and  lights up.

Memo :

- The setting will not change if "MWB" is being tapped too fast (less than 1 second).
- Manual setting is temporarily canceled in the Intelligent Auto mode.

Setting Backlight Compensation

You can correct the image when the subject appears too dark due to backlight.

1 Tap "MENU".



2 Tap "BACKLIGHT COMP.".

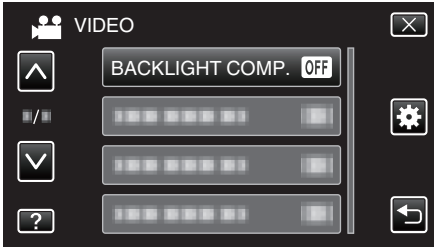

- Tap \wedge or \vee to move upward or downward for more selection.
- Tap \times to exit the menu.
- Tap \hookrightarrow to return to the previous screen.

3 Tap "ON".

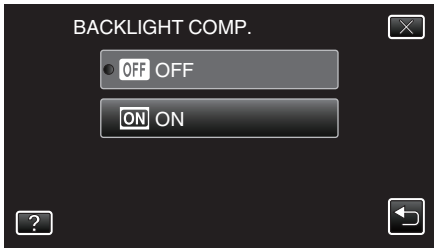

- After setting, the backlight icon  appears.

Taking Close-up Shots

You can take close-up shots of an object using the tele macro function.



*The image is only an impression.

1 Tap "MENU".



2 Tap "TELE MACRO".

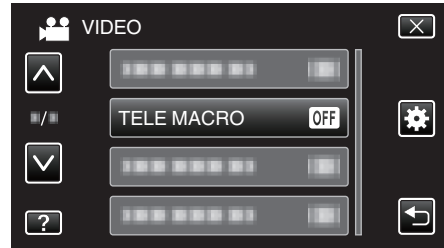

- Tap \wedge or \vee to move upward or downward for more selection.
- Tap \times to exit the menu.
- Tap \hookrightarrow to return to the previous screen.

3 Tap "ON".



- After setting, the tele macro icon  appears.

Setting	Details
OFF	Enables close-up shots up to 1 m at the telephoto (T) end. Enables close-up shots up to 5 cm at the wide angle (W) end.
ON	Enables close-up shots up to 40 cm at the telephoto (T) end. Enables close-up shots up to 5 cm at the wide angle (W) end.

Caution :

- When you are not taking close-up shots, set "TELE MACRO" to "OFF". Otherwise, the image may be blur.

Setting the USER Button

By assigning one of manual adjustment functions that you frequently use to the USER button, you can access the function quickly.

Assigning a Function to the USER Button

- 1 Tap "MENU".

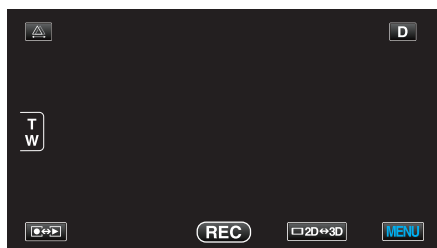

- 2 Tap "USER BUTTON SETTING".

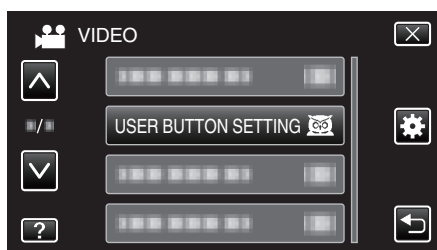

- Tap \wedge or \vee to move upward or downward for more selection.
- Tap X to exit the menu.
- Tap \leftarrow to return to the previous screen.

- 3 Select the desired function.

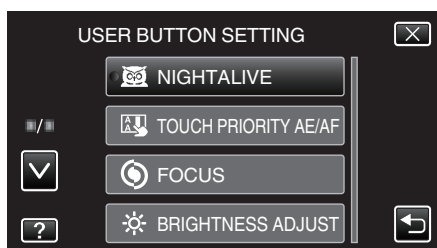

- You can select one of the following functions.
- Video mode:
 - NIGHTALIVE
 - TOUCH PRIORITY AE/AF
 - FOCUS
 - BRIGHTNESS ADJUST
 - SHUTTER SPEED
 - APERTURE PRIORITY
 - BACKLIGHT COMP.
 - WHITE BALANCE
 - FOCUS ASSIST
 - DIS
- Still image mode:
 - NIGHTALIVE
 - TOUCH PRIORITY AE/AF
 - FOCUS
 - BRIGHTNESS ADJUST
 - SHUTTER SPEED
 - APERTURE PRIORITY
 - BACKLIGHT COMP.
 - WHITE BALANCE
 - FOCUS ASSIST
 - SELF-TIMER

Making Adjustments with the USER Button

Operate as follows.

- In the case of functions that are turned on or off (NIGHTALIVE, BRIGHTNESS ADJUST, SHUTTER SPEED, APERTURE PRIORITY, BACKLIGHT COMP., DIS, FOCUS ASSIST, SELF-TIMER)

Press the USER button to turn on or off the function.

- In the case of FOCUS

Press the USER button to switch FOCUS between automatic and manual. To adjust focus manually, refer to "Adjusting Focus Manually" (p. 38). "Adjusting Focus Manually" (p. 38)

- In the case of functions that have settings to be selected (TOUCH PRIORITY AE/AF, WHITE BALANCE)

- 1) Press the USER button.
- 2) Tap the desired function to set.

Memo :

- The USER button is invalid when the menu is displayed.

Using the Control Dial for Recording

You can use the control dial to change the settings for “FOCUS”, “BRIGHTNESS ADJUST”, “SHUTTER SPEED”, “APERTURE PRIORITY”, “WHITE BALANCE”, and “PARALLAX ADJUSTMENT”.

- 1 Press the ADJ button for about 3 seconds to display the control menu.

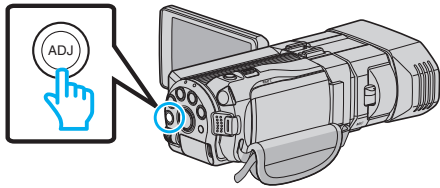

- A menu screen containing the functions that can be adjusted by the control dial is displayed.

- 2 Select the function with the control dial.

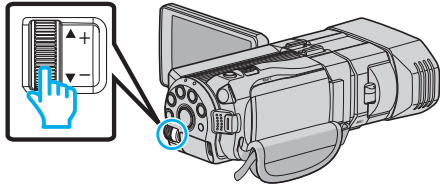

- For details on setting the items and values of each function, refer to the following.

- 1 BRIGHTNESS ADJUST
“Adjusting Brightness” (☞ p. 39)
- 2 FOCUS
“Adjusting Focus Manually” (☞ p. 38)
- 3 SHUTTER SPEED
“Setting Shutter Speed” (☞ p. 40)
- 4 APERTURE PRIORITY
“Setting Aperture” (☞ p. 40)
- 5 WHITE BALANCE
“Setting White Balance” (☞ p. 41)
- 6 PARALLAX ADJUSTMENT
“Adjusting Parallax During Recording” (☞ p. 35)
- 7 CLEAR
Select this to set all values adjusted by the ADJ button to “AUTO”.

- 3 Press the ADJ button.

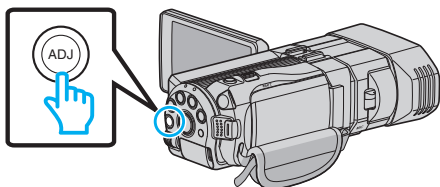

- The setting screen for the selected function appears.

- 4 Adjust the assigned function and record.

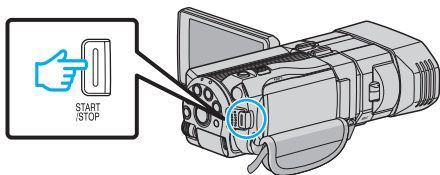

- Change the setting using the control dial.
- Press the ADJ button to set to “AUTO” or activate an assigned function.
- To change the setting of a different function, press the ADJ button for about 3 seconds. The control menu appears. Go back to step 2 and select a different function.

Memo :

- By assigning “BRIGHTNESS ADJUST”, “FOCUS”, “SHUTTER SPEED”, or “APERTURE PRIORITY” to the control dial, you can adjust the function while recording.
- Only one function can be operated by the control dial. The settings of all other functions will remain unchanged. (Example: When focus is being adjusted, the settings of brightness and shutter speed remain unchanged.)

- When “CLEAR” is selected, all values adjusted by the ADJ button will be set to “AUTO”.
(Exits the control menu.)

Caution :

- Settings cannot be changed by tapping on the screen while the control dial is being used. Change the setting with the control dial. (except PARALLAX ADJUSTMENT)
- When “3D VIDEO REC FORMAT” is set to “MP4(MVC)” and recording is performed together with HDMI output, the control menu will not be displayed.

Reducing Camera Shake

When the image stabilizer is set, camera shake during recording can be effectively reduced.

1 Tap "MENU".

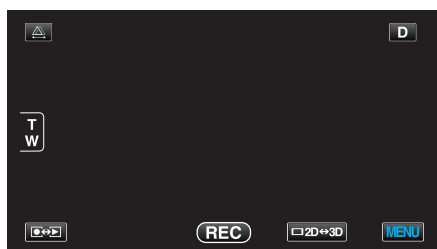

2 Tap "DIS".

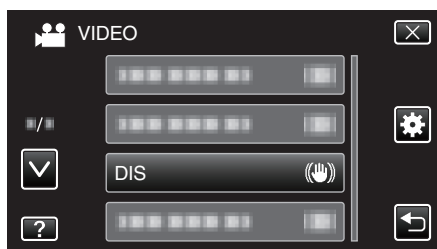

3 Tap "ON" or "ON (AIS)".

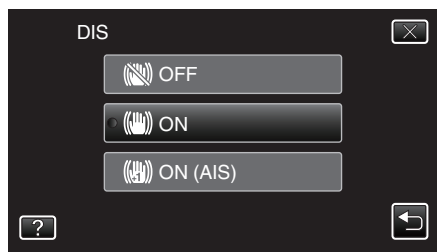

- Tap \wedge or \vee to move upward or downward for more selection.
- Tap X to exit the menu.
- Tap \rightarrow to return to the previous screen.

Display	Setting
(OFF)	Deactivates image stabilizer.
(ON)	Reduces camera shake under normal shooting conditions.
(ON (AIS))	Reduces camera shake more effectively when shooting bright scenes on the wide angle end. Only on the wide angle end (during 3D recording: approx. 5x, during 2D recording: approx. 10x).

Memo :

- It is recommended to set the image stabilizer to "OFF" when shooting a subject of little movement with the unit on a tripod.
- Complete stabilization may not be possible if camera shake is excessive.
- This setting is effective for video recording only.

Setting with the USER Button

When "DIS" is assigned to the USER button, the setting changes with every press of the button.

"Setting the USER Button" (p. 43)

• "OFF" \rightarrow "ON" \rightarrow "ON (AIS)" \rightarrow "OFF" \rightarrow

The setting changes as above with every press of the USER button.

Capturing Subjects Clearly (TOUCH PRIORITY AE/AF)

"TOUCH PRIORITY AE/AF" is a function that adjusts focus and brightness based on a tapped position.

This function is available for both videos and still images.

1 Select video or still image mode.

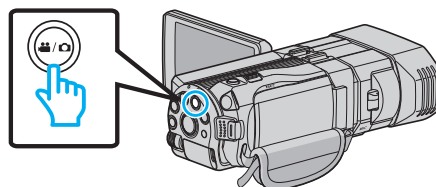

- The video or still image mode icon appears.

2 Tap "MENU".

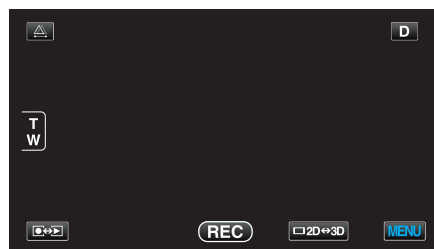

3 Tap "TOUCH PRIORITY AE/AF".

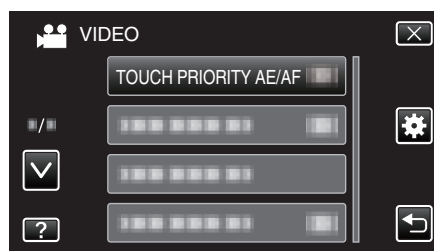

- Tap \wedge or \vee to move upward or downward for more selection.
- Tap X to exit the menu.
- Tap \rightarrow to return to the previous screen.

4 Tap the desired setting.

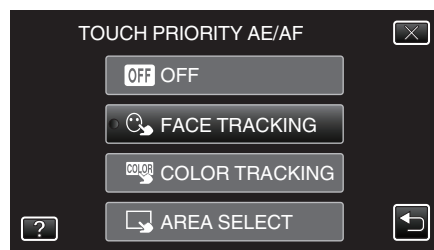

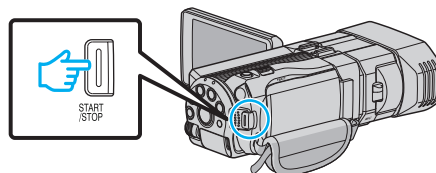

5 Start recording and tap the desired position.



- Focus and brightness will be adjusted automatically based on the tapped position (face/color/area). A blue frame appears around the selected subject (face/color), while a white frame appears around the selected area.
- To reset, tap the desired position (face/color/area) again.
- To cancel "FACE TRACKING", tap the blue frame.
- To cancel "COLOR TRACKING", tap the blue frame.
- To cancel "AREA SELECT", tap the white frame.

Setting	Details
OFF	Deactivates the function.

FACE TRACKING	 appears on the screen. Recording is performed while tracking and automatically adjusting the tapped face (subject) with appropriate focus and brightness. In addition, a blue frame appears around the tapped face (subject).
COLOR TRACKING	 appears on the screen. Recording is performed while tracking and automatically adjusting the tapped color (subject) with appropriate focus and brightness. In addition, a blue frame appears around the tapped color (subject).
AREA SELECT	 appears on the screen. Recording is performed while automatically adjusting the tapped area (fixed position) with appropriate focus and brightness. In addition, a white frame appears around the tapped area.

Memo :

- When “TOUCH PRIORITY AE/AF” is set, “FOCUS” will be set to “AUTO” automatically.
- If the camera loses track of a subject, tap the subject again.
- Settings are canceled when zoom operation is performed. (“AREA SELECT” only)
- When “COLOR TRACKING” is set, the targeted subject (color) may change if similar colors are detected. In this case, tap the subject again. The targeted subject (color) may also be tracked back again if it appears in the center of the screen within a specific time.

Caution :

- Subjects near the sides of the LCD monitor may not respond or be recognized when tapped. In this case, move the subject to the center and tap again.
- “COLOR TRACKING” may not function properly in the following cases:
 - when recording subjects with no contrast
 - when recording subjects that are moving at high speed
 - when recording in a dark place
 - when the surrounding brightness changes
- When “FACE TRACKING” is set, the subject may be lost if the camera is moved vertically or horizontally very fast. To track back the subject, tap on it again.

Capturing Smiles Automatically (SMILE SHOT)

“SMILE SHOT” automatically captures a still image upon detection of a smile.

1 Select still image mode.

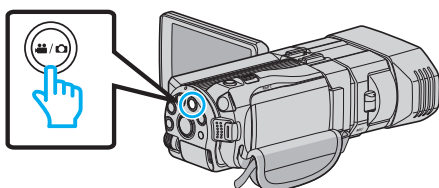

- The still image mode icon appears.

2 Tap “MENU”.

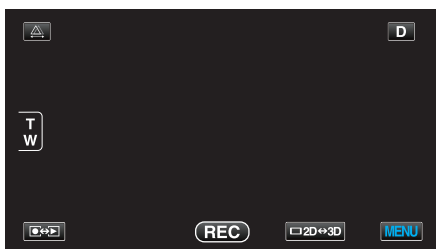

3 Tap “SMILE SHOT”.

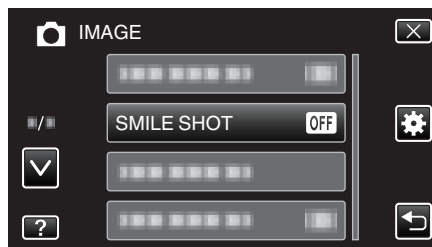

- Tap \wedge or \vee to move upward or downward for more selection.
- Tap \times to exit the menu.
- Tap \leftarrow to return to the previous screen.

4 Tap “ON”.

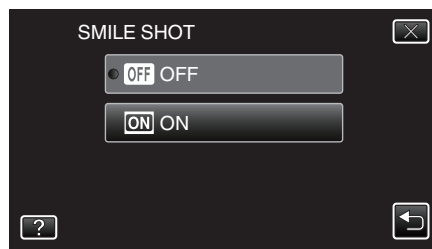

5 Point the camera toward the human subject.

- A still image is automatically captured when smiles are detected.



- PHOTO lights up when a still image is being captured.
- You can display the smile level (%) together with the frame by setting “SMILE LEVEL” in the menu to ON before recording.

“Setting SMILE LEVEL Display (Still image only)” (p. 47)

Memo :

- The camera is able to detect up to 16 faces. Smile levels will be displayed for up to 3 of the largest faces displayed on the screen.
- This function may not work properly depending on the shooting conditions (distance, angle, brightness, etc.) and the subject (direction of face, smile level, etc.). It is also difficult to detect a smile in backlight.
- After a smile is detected and captured, it takes time before the next recording may be performed.

Caution :

- When “TOUCH PRIORITY AE/AF” is set to “AREA SELECT” or “COLOR TRACKING”, “SMILE SHOT” does not work.
- If appropriate results cannot be obtained, record with “SMILE SHOT” set to “OFF”.

Setting SMILE LEVEL Display (Still image only)

“SMILE LEVEL” allows you to set the items to display when faces are detected.

This item is only displayed when “TOUCH PRIORITY AE/AF” is set to “FACE TRACKING”.

- 1 Open the LCD monitor and select the still image mode.

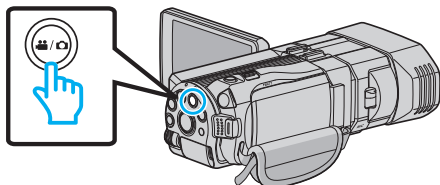

- 2 Tap “MENU”.

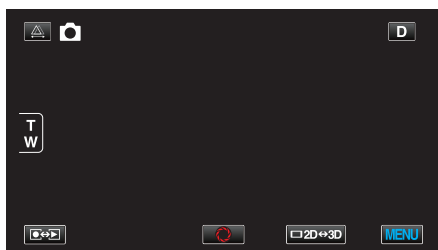

- 3 Tap “SMILE LEVEL”.

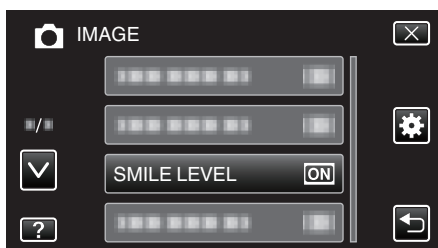

- 4 Tap “ON”.

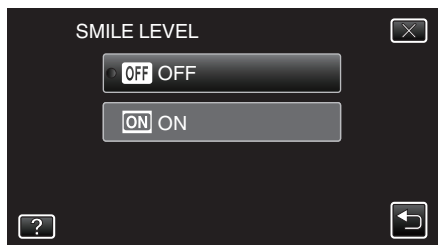

Setting	Details
OFF	Displays only the frames when faces are detected.
ON	Displays the frames and smile levels (%) when faces are detected.

- Frame: Appears around detected faces.
Smile level: Appears in value (0 % - 100 %) for detected smiles.

Recording at Intervals (TIME-LAPSE RECORDING)

Enables the changes of a scene that occur slowly over a long period to be shown within a short time by taking frames of it at a certain interval. This is useful for making observations such as the opening of a flower bud.

- 1 Open the LCD monitor and select the video mode.

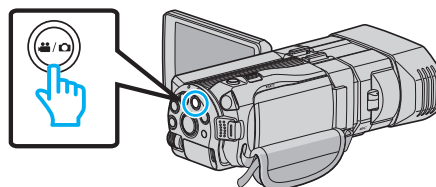

- The video mode icon  appears.

- 2 Tap “MENU”.

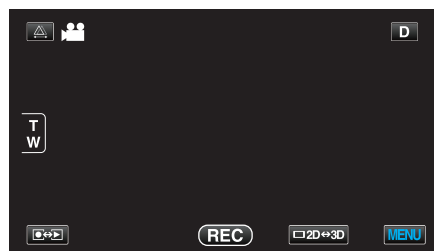

- 3 Tap “TIME-LAPSE RECORDING”.

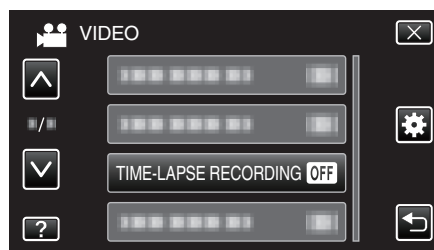

- Tap \wedge or \vee to move upward or downward for more selection.
- Tap \times to exit the menu.
- Tap \curvearrowright to return to the previous screen.

- 4 Tap to select a recording interval (1 to 80 seconds).

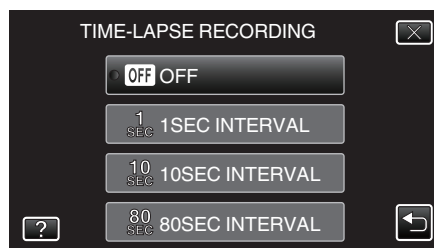

- The greater the number of seconds, the longer the recording interval.
- Tap \wedge or \vee to move upward or downward for more selection.
- Tap \times to exit the menu.
- Tap \curvearrowright to return to the previous screen.

- 5 Start recording.

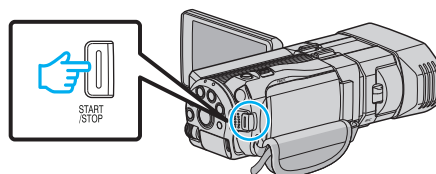

- A frame is taken at intervals of the selected period.
- When the recording interval is set to “80SEC INTERVAL”, this unit switches to the power-saving mode between recordings. At the next point to record, the power-saving mode will be turned off and recording will start automatically.
- Press the START/STOP button again to stop recording.

Indications During Time-Lapse Recording

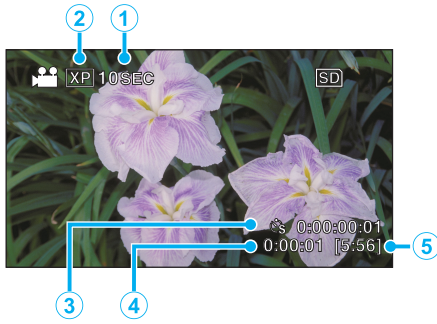

	Display	Description
①	Speed Indicator	Displays the recording interval that is set.
②	Video Quality	Displays the icon of the video quality that is set.
③	Recorded Time	Displays the actual recorded time of the video. Recorded time increases in units of frames.
④	Actual Elapsed Time	Displays the actual elapsed time after recording starts.
⑤	Remaining Recording Time	Remaining time left to record with the currently selected video quality.

Time-Lapse Setting

The greater the number of seconds, the longer the recording interval.

Setting	Details
OFF	Deactivates the function.
1SEC INTERVAL	Takes a frame at 1-second intervals. Recorded videos will be played back at 30 times speed.
10SEC INTERVAL	Takes a frame at 10-second intervals. Recorded videos will be played back at 300 times speed.
80SEC INTERVAL	Takes a frame at 80-second intervals. Recorded videos will be played back at 2 400 times speed.

Caution :

- Audio cannot be recorded during time-lapse recording.
- Zooming, simultaneous still image recording, and image stabilizer are not available in time-lapse recording.
- When recording is stopped with the recorded time less than "0:00:00:14", the video will not be saved.

Memo :

- Settings of time-lapse recording are reset when the power is turned off. To start time-lapse recording again, it is necessary to make the selection once more.
- Recording stops automatically 99 hours after it is started.
- Make use of a tripod and AC adapter for time-lapse recordings with long intervals. It is also recommended to fix the focus and white balance manually.

"Tripod Mounting" (☞ p. 22)

"Adjusting Focus Manually" (☞ p. 38)

"Setting White Balance" (☞ p. 41)

Taking Group Shots (Self-timer)

The 10-second self-timer and Face Detection self-timer are convenient functions for taking group photos.

The 2-second self-timer is useful for preventing camera shake caused by pressing the shutter button.

Memo :

When shooting a photo using the self-timer function, use of a tripod is recommended.

“Tripod Mounting” (p. 22)

Using the 2-/10-second Self-timer

- 1 Select still image mode.

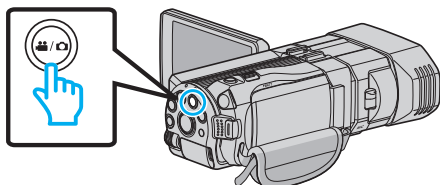



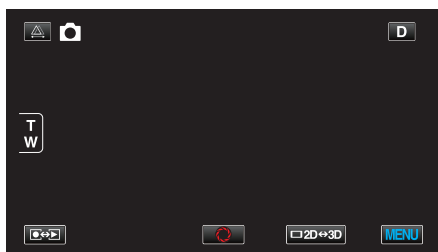

- The still image icon  appears.

- 2 Tap “MENU”.



- 3 Tap “SELF-TIMER”.



- Tap  or  to move upward or downward for more selection.
- Tap  to exit the menu.
- Tap  to return to the previous screen.

- 4 Tap “2SEC” or “10SEC”.

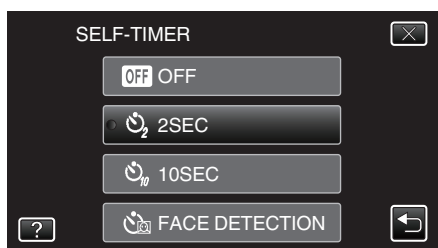

- 5 Set the focus on the subject.

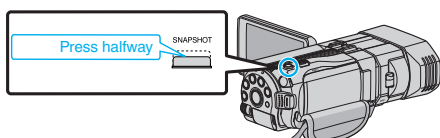

- When focused, the focus icon lights up in green.

- 6 Take a still image.

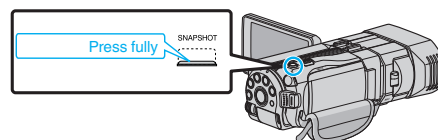

- A timer appears and countdown to shooting starts.
- To stop the self-timer, press the SNAPSHOT button again.

Using the Face Detection Self-timer

Pressing the SNAPSHOT button starts face detection, and shooting is performed three seconds after another person enters the frame.

This function is useful when you want to include the photographer in the group photo.

- 1 Select still image mode.

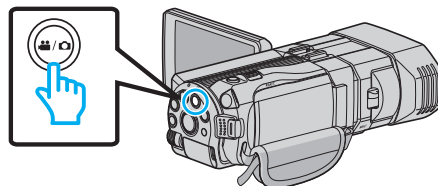



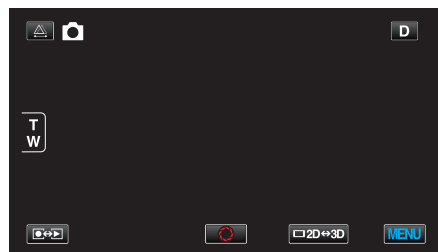

- The still image icon  appears.

- 2 Tap “MENU”.



- 3 Tap “SELF-TIMER”.



- Tap  or  to move upward or downward for more selection.
- Tap  to exit the menu.
- Tap  to return to the previous screen.

- 4 Tap “FACE DETECTION”.

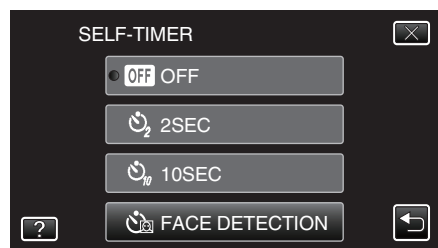

- 5 After making sure that everyone is facing the camera, press the SNAPSHOT button.

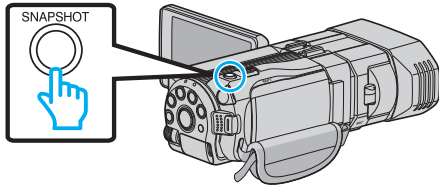

- Frames appear around the faces of the subjects.
- Pressing the SNAPSHOT button again starts the 10-second self-timer.

- 6 The photographer enters the frame.

Photographer



- The frames around the faces disappear when the photographer is detected, and a countdown timer appears.
- The shutter is released three seconds after the photographer enters the frame.
- To stop the self-timer, press the SNAPSHOT button again.

Memo :

- The "FACE DETECTION" function may fail to detect faces depending on the shooting environment.

Remaining Recording Time/Battery Power

You can check the remaining video recording time on the built-in memory and SD card as well as the remaining battery power.

- 1 Open the LCD monitor and select the video or still image mode.

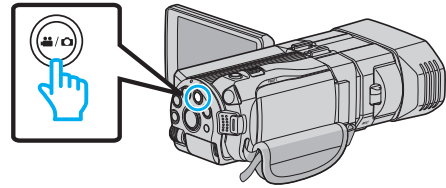

- The video or still image icon appears.

- 2 Press the INFO button.

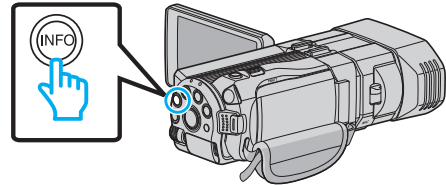

- If in the still image mode, go directly to step 4.

- 3 Display the remaining recording time.



- The remaining recording time is displayed only in the video recording mode.
- Press the INFO button to check the remaining recording time of each recording media.
- To display the remaining battery power, tap .
- Tap to return to the recording mode.
- To exit the display, tap X.

- 4 Display the remaining battery power.

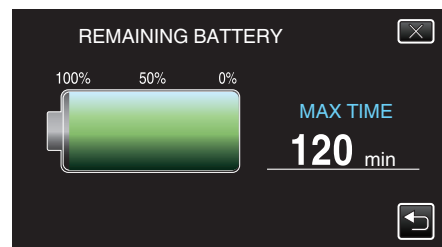

- For video recording, tap to return to the remaining recording time display. For still image recording, tap to return to the recording mode.
- To exit the display, press the INFO button or tap X.
- Remaining battery power will not be displayed when the AC adapter is connected.

Memo :

- You can change to the desired video quality by tapping on it from the remaining recording time display.

Approximate Video Recording Time

■ 3D Mode (MP4(MVC))

Quality	Built-in Memory (64 GB)	SDHC/SDXC Card					
		4 GB	8 GB	16 GB	32 GB	48 GB	64 GB
THR	4 h	10 m	30 m	1 h	2 h	3 h	4 h 10 m
TSR	6 h 10 m	20 m	40 m	1 h 30 m	3 h 10 m	4 h 40 m	6 h 20 m

■ 3D Mode (AVCHD)

Quality	Built-in Memory (64 GB)	SDHC/SDXC Card					
		4 GB	8 GB	16 GB	32 GB	48 GB	64 GB
TXP	8 h 10 m	30 m	1 h	2 h	4 h 10 m	6 h 10 m	8 h 20 m
TSP	11 h 40 m	40 m	1 h 20 m	2 h 50 m	5 h 50 m	8 h 40 m	11 h 50 m

■ 2D Mode

Quality	Built-in Memory (64 GB)	SDHC/SDXC Card					
		4 GB	8 GB	16 GB	32 GB	48 GB	64 GB
UXP	5 h 50 m	20 m	40 m	1 h 20 m	2 h 50 m	4 h 20 m	5 h 50 m
XP	8 h 10 m	30 m	1 h	2 h	4 h 10 m	6 h 10 m	8 h 20 m
SP	11 h 40 m	40 m	1 h 20 m	2 h 50 m	5 h 50 m	8 h 40 m	11 h 50 m
EP	29 h 10 m	1 h 40 m	3 h 40 m	7 h 10 m	14 h 50 m	21 h 50 m	29 h 50 m

For customers who completed the firmware update

■ 3D Mode (AVCHD 3D)

Built-in Memory (64 GB)	SDHC/SDXC Card					
	4 GB	8 GB	16 GB	32 GB	48 GB	64 GB
5 h 10 m	10 m	30 m	1 h 10 m	2 h 30 m	3 h 50 m	5 h 10 m

- The actual recording time may shorten depending on the shooting environment.

Approximate Number of Still Images (Unit: Number of Shots)

■ 3D Mode

Image Size	SDHC Card				Built-in Memory (64 GB)
	4 GB	8 GB	16 GB	32 GB	
1920X1080(2M)(16:9)	1,000	2,200	4,400	4,999	4,999

■ 2D Mode

Image Size	SDHC Card				Built-in Memory (64 GB)
	4 GB	8 GB	16 GB	32 GB	
2304X1296(2.9M)(16:9)	2,200	4,600	9,100	9,999	9,999
1920X1080(2M)(16:9)	3,200	6,700	9,999	9,999	9,999
1728X1296(2.2M)(4:3)	3,000	6,200	9,999	9,999	9,999
640X480(0.3M)(4:3)	9,999	9,999	9,999	9,999	9,999

- Regardless of image size and quality, up to 9999 still images may be recorded on the built-in memory (during 2D mode) and SD cards with at least 16 GB capacity (except for "2,304 x 1,296 (2.9M) (16:9)").

Recording

Approximate Recording Time (Using Battery)

■ 3D Display on LCD Monitor

Battery Pack	Actual Recording Time		
	3D Recording MP4(MVC)	3D Recording AVCHD 3D *	3D Recording AVCHD
BN-VF815U (Supplied)	55 m	55 m	1 h
BN-VF823U	1 h 20 m	1 h 20 m	1 h 35 m

Battery Pack	Continuous Recording Time		
	3D Recording MP4(MVC)	3D Recording AVCHD 3D *	3D Recording AVCHD
BN-VF815U (Supplied)	1 h 45 m	1 h 45 m	2 h
BN-VF823U	2 h 40 m	2 h 40 m	3 h 5 m

■ 2D Display on LCD Monitor

Battery Pack	Actual Recording Time			
	3D Recording MP4(MVC)	3D Recording AVCHD 3D *	3D Recording AVCHD	2D Recording
BN-VF815U (Supplied)	55 m	55 m	1 h 5 m	1 h 20 m
BN-VF823U	1 h 25 m	1 h 25 m	1 h 40 m	1 h 55 m

Battery Pack	Continuous Recording Time			Continuous Recording Time
	3D Recording MP4(MVC)	3D Recording AVCHD 3D *	3D Recording AVCHD	
BN-VF815U (Supplied)	1 h 50 m	1 h 50 m	2 h 10 m	2 h 35 m
BN-VF823U	2 h 45 m	2 h 45 m	3 h 15 m	3 h 50 m

- The above are values when "MONITOR BRIGHTNESS" is set to "STANDARD".
- The actual recording time may be shorter if zooming is used or if recording is stopped repeatedly. (It is recommended to prepare battery packs ready for three times the expected recording time.)
- When the battery life is reached, the recording time becomes shorter even if the battery pack is fully charged. (Replace the battery pack with a new one.)

* For customers who completed the firmware update

Playing Back Videos

You can select and play back the recorded videos from an index screen (thumbnail display).

- 1 Select video mode.

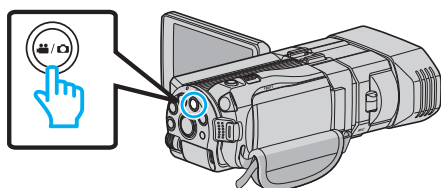

- The video mode icon  appears.

- 2 Tap  to select the playback mode.

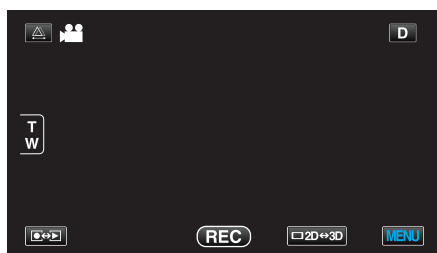

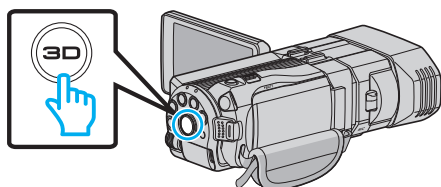

- 3 Press the 3D button to select 3D or 2D mode.



- Images recorded in 3D mode and 2D mode are displayed on the index screen separately. Press the 3D button to switch to the desired mode for playback.
- During 3D mode, "3D" is displayed on the LCD monitor.
- During 2D mode, "2D" is displayed on the LCD monitor.

- 4 Tap on the file to start playback.



- Tap  SD to select the media for playback and change the index screen (thumbnail display).
- Tap  to pause.
- Tap  to return to the index screen.

Memo :

- Images recorded in 2D mode cannot be displayed as 3D images.
- 3D images may be played back when the 3D button lights up.
- Images recorded in 3D mode and 2D mode are displayed on the index screen separately. Press the 3D button to switch to the desired mode for playback.
- 3D images recorded in "MP4(MVC)" format and "AVCHD" format are displayed on the index screen separately. Change the setting of 3D VIDEO REC FORMAT to the desired format for playback.

"3D VIDEO REC FORMAT (3D mode only)" (p. 107)

- It is recommended to play back in stop-motion for scenes that are likely to cause motion sickness during 3D playback.
- By default, "3D MOTION RELIEF" is set to "ON". Scenes that are likely to cause motion sickness during 3D playback may be played back in stop-motion, but this is not a malfunction. To play back normally, set "3D MOTION RELIEF" to "OFF".

"3D MOTION RELIEF (3D mode only)" (p. 120)

For customers who completed the firmware update: _____

- 3D images recorded in "MP4(MVC)" format, "AVCHD 3D" format and "AVCHD" format are displayed on the index screen separately. Change the setting of 3D VIDEO REC FORMAT to the desired format for playback.

"3D VIDEO REC FORMAT (3D mode only)" (p. 107)

Caution :

- To play back 3D images, refer also to "Precautions on Recording and Playing Back 3D Images".

"Precautions on Recording and Playing Back 3D Images" (p. 11)

Operation Buttons for Video Playback

During Index Screen Display

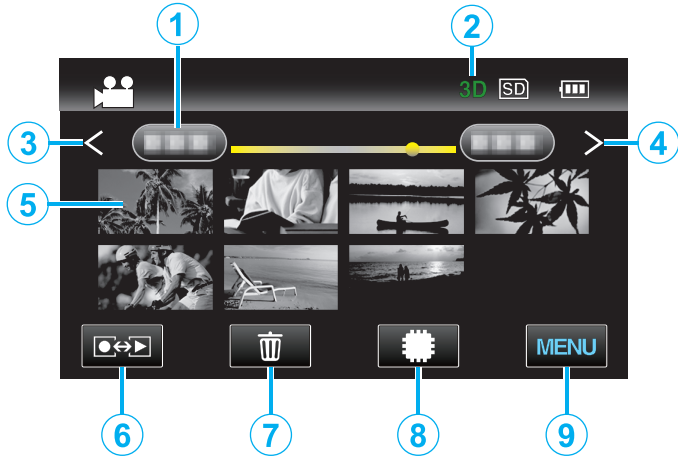

	Display	Description
①	Date	Moves to the previous/next date
②	3D/2D Mode	Displays the current playback mode of 3D or 2D. "3D" is displayed during 3D playback, while "2D" is displayed during 2D playback.
③	<	Displays the previous index screen (thumbnail display)
④	>	Displays the next index screen (thumbnail display)
⑤	Thumbnail (File)	Tap on thumbnail - Starts playback Drag to right - Scrolls to the right to show the previous index screen (thumbnail display) Drag to left - Scrolls to the left to show the next index screen (thumbnail display)
⑥	Recording/ Playback Mode [Icon]	Switches between recording and playback modes.
⑦	[Icon]	Displays the index screen (thumbnail display) to perform deletion
⑧	[Icon] SD	Switches between the index screen of the built-in memory and SD card
⑨	MENU	Displays the menu screen

During Video Playback

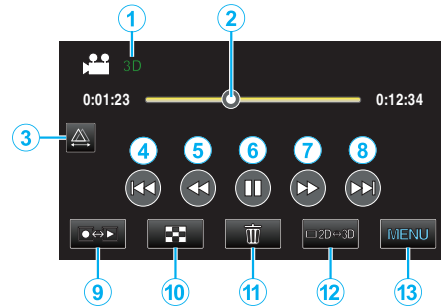

	Display	Description
①	3D/2D Mode	Displays the current playback mode of 3D or 2D. "3D" is displayed during 3D playback, while "2D" is displayed during 2D playback.
②	Pointer	Displays the current estimated playback position within the scene
③	[Icon]	Enables manual parallax adjustment
④	[Icon]	Returns to the beginning of the scene
⑤	[Icon]	Reverse search
⑥	[Icon]	Playback/pause
⑦	[Icon]	Forward search
⑧	[Icon]	Advances to the next video
⑨	Recording/ Playback Mode [Icon]	Switches between recording and playback modes.
⑩	[Icon]	Stop (returns to index screen)
⑪	[Icon]	Displays the index screen (thumbnail display) to perform deletion
⑫	[Icon] 2D↔3D	Switches between 3D and 2D modes.
⑬	MENU	Displays the menu screen

Memo :

- Tap or drag on the operation area of the touch screen.
- Operations buttons on the touch screen disappear if the unit is not operated for about 5 seconds. Tap on the screen to display the operation buttons again.
- Operation buttons on the touch screen are displayed as long as there is contact with the effective operation area.
- You can search for a specific file by the recording date. "Date Search" (p. 59)

Caution :

- Make a backup of important recorded data. It is recommended to copy your important recorded data to a DVD or other recording media for storage. JVC will not be responsible for any lost data.

Adjusting the Volume of Videos

- 1 Press the zoom lever during video playback.

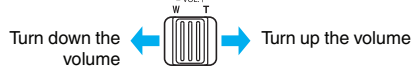

Checking the Recording Date and Other Information

- 1 Select a file and press the INFO button while playback is paused. You can display the recording date and duration of the selected file.

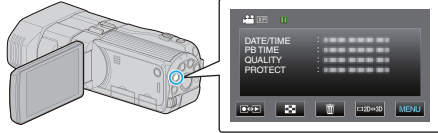

Playing a Video with Defective Management Information

Plays videos with defective management information.

- 1 Select video mode.

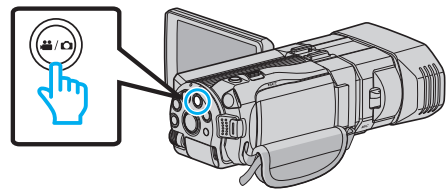

- 2 Tap to select the playback mode.

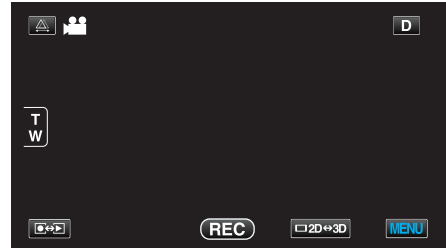

- 3 Tap "MENU".



- 4 Tap "PLAYBACK OTHER FILE".

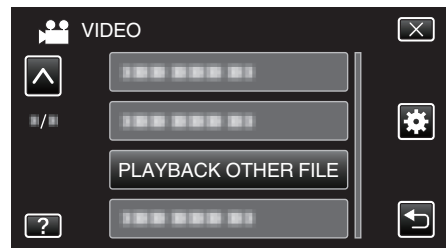

- 5 Tap on the file to start playback.



"Playing Back Videos" (p. 54)

Memo :

- An MTS file is created in the EXTMOV folder when management information is corrupted.
- The thumbnails of the 3D files in the EXTMOV folder will be shown as images separated into left and right on the index screen but this is not a malfunction.
- Depending on the condition of the damaged file, playback might fail or may not run smoothly.

Playing Back Still Images

You can select and play back the recorded still images from an index screen (thumbnail display).

The contents of the selected media are displayed on the index screen.

“REC MEDIA FOR IMAGE” (☞ p. 126)

- 1 Select still image mode.

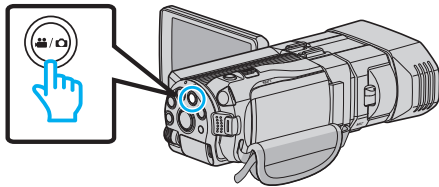

- 2 Tap to select the playback mode.

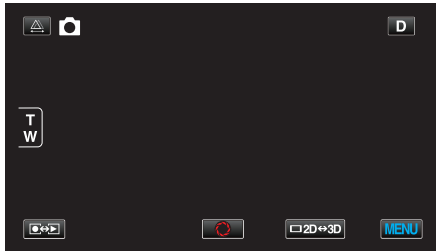

- 3 Press the 3D button to select 3D or 2D mode.

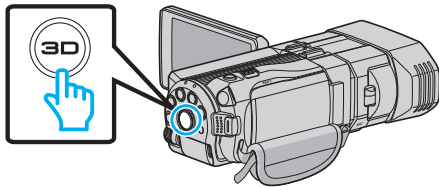

- Images recorded in 3D mode and 2D mode are displayed on the index screen separately. Press the 3D button to switch to the desired mode for playback.
- During 3D mode, “3D” is displayed on the LCD monitor.
- During 2D mode, “2D” is displayed on the LCD monitor.

- 4 Tap on the file to start playback.



- Tap to select the media for playback and change the index screen (thumbnail display).
- Tap to return to the index screen.
- Tap to show all the thumbnails that are displayed in a group. Tap again to restore the group.

Memo :

- Only 3D images are displayed during the 3D mode. Similarly, only 2D images are displayed during the 2D mode.
- 3D images may be played back when the 3D button lights up.
- You can search for a specific file by the recording date. This is useful when searching from a large number of files.

“Date Search” (☞ p. 59)

Caution :

- To play back 3D images, refer also to “Precautions on Recording and Playing Back 3D Images”.

“Precautions on Recording and Playing Back 3D Images” (☞ p. 11)

Operation Buttons for Still Image Playback

During Index Screen Display

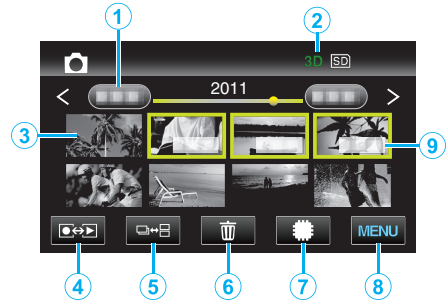

	Display	Description
①	Date	Moves to the previous/next date
②	3D/2D Mode	Displays the current playback mode of 3D or 2D. “3D” is displayed during 3D playback, while “2D” is displayed during 2D playback.
③	Thumbnail (File)	Tap on thumbnail - Starts playback Drag to right - Scrolls to the right to show the previous index screen (thumbnail display) Drag to left - Scrolls to the left to show the next index screen (thumbnail display)
④	Recording/Playback Mode 	Switches between recording and playback modes.
⑤		Switches between the group or full index screen displays.
⑥		Displays the index screen (thumbnail display) to perform deletion
⑦		Switches between the index screen of the built-in memory and SD card
⑧	MENU	Displays the menu screen
⑨	Recording Date	Recording date (only displayed on the first file of each date)

During Still Image Playback

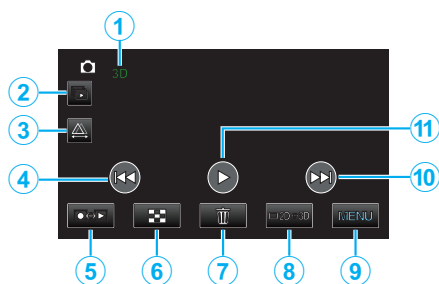

	Display	Description
①	3D/2D Mode	Displays the current playback mode of 3D or 2D. "3D" is displayed during 3D playback, while "2D" is displayed during 2D playback.
②		Continuous playback of grouped files (such as still images captured by continuous shooting).
③		Enables manual parallax adjustment
④		Returns to the previous still image
⑤	Recording/ Playback Mode 	Switches between recording and playback modes.
⑥		Returns to index screen
⑦		Displays the index screen (thumbnail display) to perform deletion
⑧		Switches between 3D and 2D modes.
⑨	MENU	Displays the menu screen
⑩		Advances to the next still image
⑪		Starts/pauses slideshow "Slideshow Playback" (see p. 58)

Memo :

- Tap or drag on the operation area of the touch screen.
- Operations buttons on the touch screen disappear if the unit is not operated for about 5 seconds. Tap on the screen to display the operation buttons again.
- Operation buttons on the touch screen are displayed as long as there is contact with the effective operation area.

Checking the Recording Date and Other Information

- 1 Press the INFO button.
You can display the recording date of the selected file.

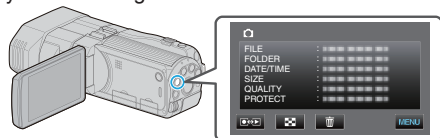

Adjusting Parallax During Playback

When playing back 3D images of scenes where there are multiple objects arrayed in a line from near to far, or objects that are extremely close to the camera, you can change the way they appear to the eye.

- Parallax can only be adjusted when 3D images are displayed on the unit's LCD monitor.

- 1 Tap



- 2 Tap "MANUAL".

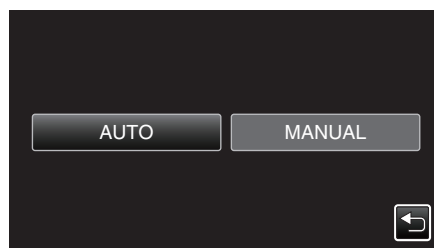

- The parallax adjustment screen appears.
- To set parallax adjustment to auto (default), tap "AUTO".

- 3 Adjust the parallax.

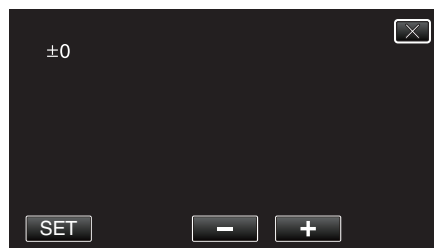

- To increase the amount of correction, tap "+". Doing so increases the value of the parallax display.
- To reduce the amount of correction, tap "-". Doing so decreases the value of the parallax display.

- 4 Tap "SET" to confirm.

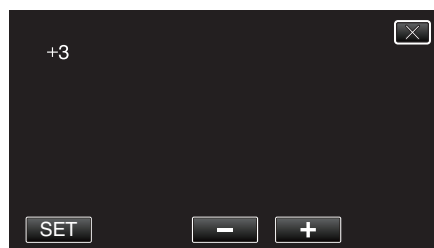

Caution :

- Too much parallax may cause the 3D effect to be lost.
- If you see double images even after parallax adjustment, set the display on the TV to 2D immediately. In addition, set the LCD monitor to 2D display accordingly.

Memo :

- While this unit is equipped with the function to adjust parallax automatically, it may not work properly for the following subjects.
 - Subjects beyond the recommended shooting distance (especially subjects that are extremely close to the camera)
 - Numerous subjects of the similar shape arrayed in a line, such as the windows of a building
 - Straight subjects such as electric wires
 In these cases, adjust the parallax manually.

- When the power of this unit is turned off or the mode is switched to recording after parallax is manually adjusted, the “PARALLAX ADJUSTMENT” setting returns to “AUTO”.

Slideshow Playback

Still images can be played back in a slideshow.

- 1 Select still image mode.

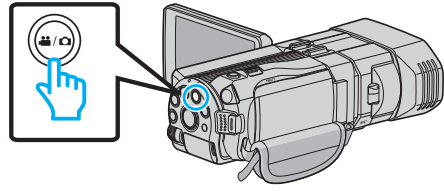

- 2 Tap  to select the playback mode.



- 3 Press the 3D button to select 3D or 2D mode.

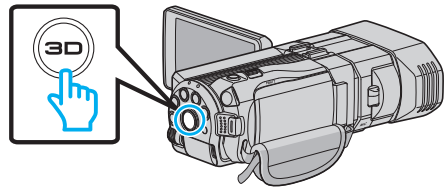

- Images recorded in 3D mode and 2D mode are displayed on the index screen separately. Press the 3D button to switch to the desired mode for playback.
- During 3D mode, “3D” is displayed on the LCD monitor.
- During 2D mode, “2D” is displayed on the LCD monitor.

- 4 Tap on the thumbnail and tap .



“Operation Buttons for Still Image Playback” (p. 56)

Searching for a Specific Video/Still Image

When there is a large number of recorded videos and still images, it is difficult to look for the desired file from the index screen.

Use the search function to find the file you want.

- For both videos and still images, you can search by “SEARCH DATE” (recording date).

“To search by recording dates” (☞ p. 59)

Date Search

You can search and play videos or still images according to recording dates.

- The contents of the media selected in “REC MEDIA FOR VIDEO” or “REC MEDIA FOR IMAGE” are searched.

- 1 Tap “MENU”.



- Searching can be performed in both the video and still image modes.
*The image shows the video mode.

- 2 Tap “SEARCH DATE”.

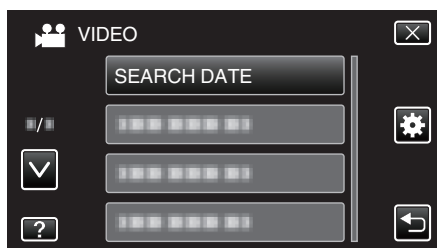

- 3 Select a recording date and tap “NEXT”.

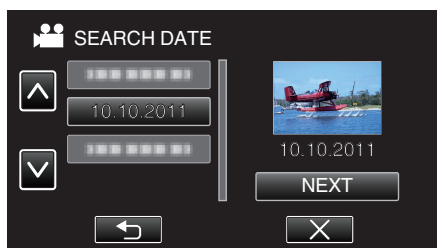

- Tap again to cancel the selected date.

- 4 Tap on the file to start playback.



- You can select videos in the video mode and still images in the still image mode.
- Only the files recorded on the selected date are displayed.

Deleting Files of a Selected Date:

Tap  on the index screen (thumbnail display) to delete unwanted files.

“Deleting Unwanted Files” (☞ p. 67)

Connecting to and Viewing on TV

You can connect this unit to a TV for playback. Select the most suitable way of connecting to the TV based on the image to view (3D/2D image).

- Refer also to the instruction manual of the TV in use.

“Playing Back 3D Images” (☞ p. 59)

“Playing Back 2D Images” (☞ p. 61)

Unnatural Displays on TV

Trouble	Action
Images do not appear on the TV properly.	<ul style="list-style-type: none"> • Disconnect the cable and connect again. • Turn off and on this unit again.
Images are projected vertically on the TV.	<ul style="list-style-type: none"> • Set “VIDEO OUTPUT” in the “COMMON” menu to “4:3”. • “VIDEO OUTPUT (2D mode only)” (☞ p. 130)
Images are projected horizontally on the TV.	<ul style="list-style-type: none"> • Adjust the TV's screen accordingly.
The color of images looks strange.	<ul style="list-style-type: none"> • If the video was recorded with “x.v.Color” set to “ON”, set the x.v.Color setting of the TV to on. • “x.v.Color (2D mode only)” (☞ p. 110) • Adjust the TV's screen accordingly.
HDMI-CEC functions do not work properly, and the TV does not work in conjunction with this unit.	<ul style="list-style-type: none"> • TVs may operate differently depending on the specifications, even if they are HDMI-CEC compliant. Therefore, the HDMI-CEC functions of this unit cannot be guaranteed to operate in combination with all the TVs. In such cases, set “HDMI CONTROL” to “OFF”. • “HDMI CONTROL” (☞ p. 132)
The language on the display changed.	<ul style="list-style-type: none"> • It may occur when you connect this unit to a TV with different language setting using an HDMI mini cable.
3D images are not displayed in 3D.	<ul style="list-style-type: none"> • Set “HDMI OUTPUT” in the “COMMON” menu to “CERTAIN TV TYPES”. • “HDMI OUTPUT” (☞ p. 131)

Memo :

- Fatigue or discomfort may be experienced if you view 3D images for a long period of time. When viewing 3D images on this unit, a message will be displayed every 30 minutes. To turn off the message display, set “3D DISPLAY WARNING” to “OFF”.

“3D DISPLAY WARNING (3D mode only)” (☞ p. 130)

- When recording 3D images, parallax is automatically adjusted. If the left and right images of an object close to the camera do not appear to be in alignment, or the 3D effect of a distant object is weak, you can change the way they appear to the eye by adjusting the parallax.

“Adjusting Parallax During Playback” (☞ p. 57)

- You can enjoy realistic audio sounds by viewing the video from the center of the TV or center of the right and left speakers.

Playing Back 3D Images

If you are using a 3D compatible TV, you can play back 3D images by connecting to the HDMI connector.

- Use the provided HDMI mini cable or an optional High Speed HDMI mini cable.
- Refer also to the instruction manual of the TV in use.

- 1 Close the LCD monitor.

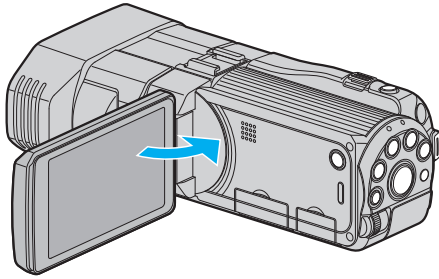

- Close the LCD monitor to turn off the camcorder before connecting to a TV.

2 Connect to a TV.

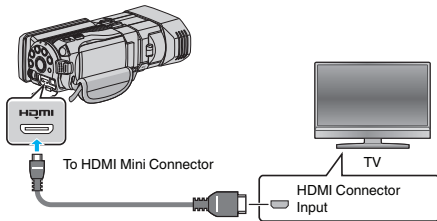

3 Connect the AC adapter to this unit.

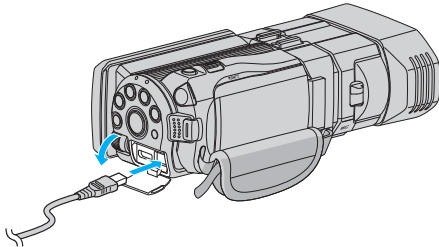

- This unit powers on automatically when the LCD monitor is opened.

4 Press the external input button on the TV to switch to the input from this unit via the connected connector.

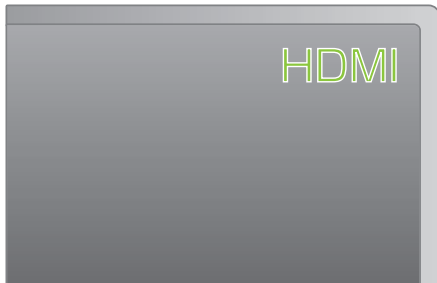

5 Play back a file.



- “Playing Back Videos” (☞ p. 53)
- “Playing Back Still Images” (☞ p. 56)

Caution :

- To play back 3D images, refer also to “Precautions on Recording and Playing Back 3D Images”.
- “Precautions on Recording and Playing Back 3D Images” (☞ p. 11)
- If you experience fatigue or discomfort while viewing 3D images, set “HDMI OUTPUT” in the “COMMON” menu to “2D OUTPUT”. In addition, set the TV to 2D display accordingly.
- “HDMI OUTPUT” (☞ p. 131)

Memo :

- When connected to the TV via the provided HDMI mini cable, images and sounds may not be output properly depending on the TV connected.

In such cases, perform the following operations.

- 1) Disconnect the HDMI mini cable and connect it again.
- 2) Turn off and on this unit again.

- If 3D images cannot be seen properly, change the setting in “HDMI OUTPUT”. Refer also to the instruction manual of the TV in use.

“HDMI OUTPUT” (☞ p. 131)

- The displayed 3D images may vary depending on the size of the TV connected.
- For questions about the TV or method of connection, contact your TV’s manufacturer.

“Connecting via the AV Connector” (p. 63)

Operating in Conjunction with TV via HDMI

Connecting this unit to an HDMI-CEC-enabled TV using the HDMI cable allows linked operations with the TV to be performed.

- HDMI-CEC (Consumer Electronics Control) is an industry standard that enables interoperability between HDMI-CEC compliant devices that are connected via HDMI cables.

Memo :

- Not all HDMI-control devices comply with the HDMI-CEC standard. The HDMI control function of this unit will not work when connected to these devices.
- This unit is not guaranteed to operate with all HDMI-CEC-enabled devices.
- Depending on the specifications of each HDMI-CEC-enabled device, some functions may not work with this unit. (For details, refer to the instruction manual of your TV.)
- Unintended operations may occur with some connected devices. In these cases, set “HDMI CONTROL” to “OFF”.

“HDMI CONTROL” (p. 132)

Preparations

- Close the LCD monitor to turn off the camcorder before connecting to a TV.
- Connect an HDMI cable between this unit and the TV.

“Connecting via the HDMI Mini Connector” (p. 62)

- Turn on the TV and set the HDMI-CEC related setting to “ON”. (For details, refer to the instruction manual of the TV.)
- Turn on this unit and set “HDMI CONTROL” in the “COMMON” menu to “ON”.

“HDMI CONTROL” (p. 132)

Operation Method 1

- 1 Turn on this unit.
- 2 Select the playback mode.
- 3 Connect the HDMI cable.
 - TV turns on automatically and switches to HDMI input mode when this unit is turned on.

Operation Method 2

- 1 Turn off the TV.
 - This unit turns off automatically.

Memo :

- Depending on the TV connected, the display language of this unit will automatically switch to the language that is selected for the TV when this unit is turned on.
(This is applicable only if this unit supports the language selected for the TV.) To use this unit with a language that differs from the display language of the TV, set “HDMI CONTROL” to “OFF”.
- The display language of the TV will not switch automatically, even if the display language of this unit is changed.
- These functions may not work correctly when devices such as amplifier and selector are connected. Set “HDMI CONTROL” to “OFF”.
- If HDMI-CEC does not work properly, turn off and on this unit again.

Caution :

- Do not remove the recording medium or perform any other operation (such as turning off the power) while accessing files. Also, be sure to use the provided AC adapter, as the data on the recording medium may be corrupted if the battery becomes exhausted during operation. If the data on the recording medium becomes corrupted, format the recording medium to use the medium again.

Playing Back 2D Images

The image quality on TV varies with the type of TV and the connecting cable. Select the connector that best suits your TV.

- Refer also to the instruction manual of the TV in use.

“Connecting via the HDMI Mini Connector” (p. 62)

Connecting via the HDMI Mini Connector

If you are using an HDTV, you can play back in HD quality by connecting to the HDMI connector.

- Use a High Speed HDMI Cable.
- Refer also to the instruction manual of the TV in use.

1 Close the LCD monitor.

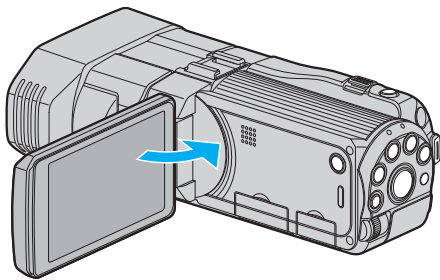

- Close the LCD monitor to turn off the camcorder before connecting to a TV.

2 Connect to a TV.

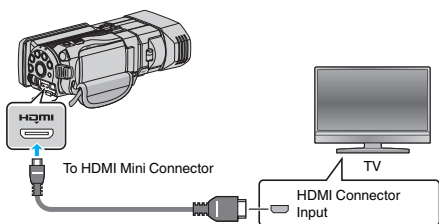

3 Connect the AC adapter to this unit.

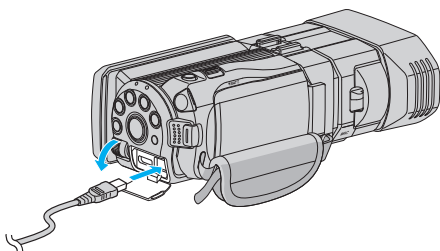

- This unit powers on automatically when the LCD monitor is opened.

4 Press the external input button on the TV to switch to the input from this unit via the connected connector.



5 Play back a file.



“Playing Back Videos” (☞ p. 53)

“Playing Back Still Images” (☞ p. 56)

Memo :

- Change the settings in “HDMI OUTPUT” according to the connection.
“HDMI OUTPUT” (☞ p. 131)

- When connected to the TV via the HDMI mini cable, images and sounds may not be output properly depending on the TV connected. In such cases, perform the following operations.
 - 1) Disconnect the HDMI mini cable and connect it again.
 - 2) Turn off and on this unit again.
- For questions about the TV or method of connection, contact your TV's manufacturer.

Connecting via the AV Connector

By connecting the supplied AV cable to the AV connector, videos can be played back on a TV.

- Refer also to the instruction manual of the TV in use.

- 1 Open the LCD monitor, then press and hold the power button for 2 seconds or more to turn off the power.

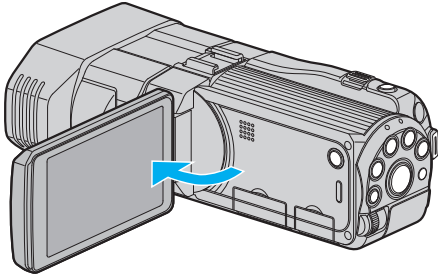

- 2 Connect to a TV.

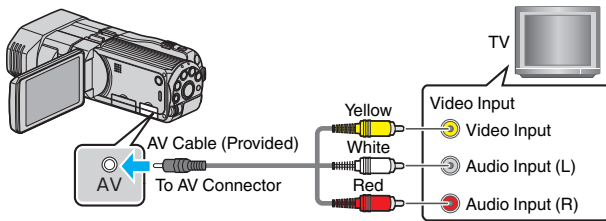

- 1 Connect using the provided AV cable.
 - 2 Connect the AC adapter to this unit.
- This unit powers on automatically when the AC adapter is connected.
- 3 Press the external input button on the TV to switch to the input from this unit via the connected connector.

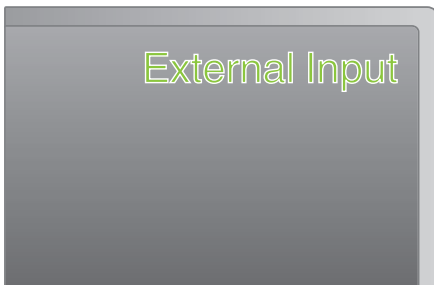

- 4 Play back a file.



“Playing Back Videos” (☰ p. 53)

“Playing Back Still Images” (☰ p. 56)

Memo :

- For questions about the TV or method of connection, contact your TV's manufacturer.

Playing Back a DVD or Blu-ray Disc Created on this Unit

BD/DVDs created using the backup function on this unit can be played back on TV using an optional DVD writer (DVDs only) with playback function (CU-VD50U) or a normal BD/DVD player. DVDs can also be played back on this unit by connecting the optional DVD writer with playback function.

“Playing Back with a DVD Writer” (☞ p. 79)

“Playing Back with an External Blu-ray Drive” (☞ p. 84)

“Playing Back Files in the USB External Hard Disk Drive” (☞ p. 88)

- For details on how to play back on a normal DVD or Blu-ray disc player, refer to the instruction manual of the player.

■ 3D (MP4(MVC)) Files

✓: Can be played back, -: Cannot be played back

Playback Device	DVD (DVD-Video format)	DVD (AVCHD format)	Blu-ray Disc	Device's Internal HDD
DVD writer with playback function (CU-VD3, CU-VD50)	-	-	-	-
External Blu-ray drive connected to this unit	-	-	✓	-
DVD player/ DVD recorder	-	-	-	-
Blu-ray player/ Blu-ray recorder	-	-	-	-
USB external hard disk drive	-	-	-	✓
Computer	-	-	-	*

* Use Everio MediaBrowser 3D Player to play back an MP4(MVC) file on the computer. Refer to the help file of the provided Everio MediaBrowser 3D software to operate.

Memo :

- Videos recorded in MP4(MVC) format can be copied or played back only when dubbed to a Blu-ray disc or hard disk drive.
Copy or play back by connecting this unit to an external Blu-ray drive or USB external hard disk drive.
- When there are many files in the disc, it may take time for them to be displayed on the screen. Wait for a while as the access lamp appears blinking, which indicates normal operation.

■ 3D (AVCHD) Files

✓: Can be played back, -: Cannot be played back

Playback Device	DVD (DVD-Video format)	DVD (AVCHD format)	Blu-ray Disc	Device's Internal HDD
DVD writer with playback function (CU-VD3, CU-VD50)	-	✓	-	-
External Blu-ray drive connected to this unit	-	✓	✓	-
DVD player/ DVD recorder	-	✓*1	-	✓
Blu-ray player/ Blu-ray recorder	-	✓*1	✓*1	✓
USB external hard disk drive	-	-	-	✓
Computer	-	*2	*2	*2

*1: only on AVCHD or AVCHD 3D compatible devices

*2: Use Everio MediaBrowser 3D Player to play back an AVCHD file on the computer. Refer to the help file of the provided Everio MediaBrowser 3D software to operate.

Memo :

- When AVCHD files recorded in 3D are played back on a normal recorder or player, the left and right images will be displayed separately.
- When there are many files in the disc, it may take time for them to be displayed on the screen. Wait for a while as the access lamp appears blinking, which indicates normal operation.

■ 2D Files

✓: Can be played back, -: Cannot be played back

Playback Device	DVD (DVD-Video format)	DVD (AVCHD format)	Blu-ray Disc	Device's Internal HDD
DVD writer with playback function (CU-VD3, CU-VD50)	✓	✓	-	-
External Blu-ray drive connected to this unit	✓	✓	✓	-
DVD player/ DVD recorder	✓	✓*1	-	✓
Blu-ray player/ Blu-ray recorder	✓	✓*1	✓*1	✓
USB external hard disk drive	-	-	-	✓
Computer	✓	*2	*2	✓

*1: Only on AVCHD compatible devices.

*2: Use Everio MediaBrowser 3D Player to play back an AVCHD file on the computer. Refer to the help file of the provided Everio MediaBrowser 3D software to operate.

Memo :

- When there are many files in the disc, it may take time for them to be displayed on the screen. Wait for a while as the access lamp appears blinking, which indicates normal operation.

Caution :

- DVDs that are created in AVCHD format cannot be played back on DVD players with standard quality. You may not be able to remove the disc from the player.

For customers who completed the firmware update

■ Files recorded in 3D (AVCHD 3D) mode

✓: Can be played back, -: Cannot be played back

Playback Device	DVD (DVD-Video format)	DVD (AVCHD format)	Blu-ray Disc	Device's Internal HDD
DVD writer with playback function (CU-VD3, CU-VD50)	-	-	-	-
External Blu-ray drive connected to this unit	-	-	✓	-
DVD player/ DVD recorder	-	-	-	-
Blu-ray player/ Blu-ray recorder	-	-	✓*1	✓*1
USB external hard disk drive	-	-	-	✓
Computer	-	-	*2	*2

*1: only on AVCHD 3D compatible devices

*2 Use Everio MediaBrowser 3D Player to play back an AVCHD 3D file on the computer. Refer to the help file of the provided Everio MediaBrowser 3D software to operate.

Memo :

- When saving or playing back the videos recorded in AVCHD 3D format by using the USB external hard disk drive, connect the USB external hard disk drive to this unit.
- When there are many files in the disc, it may take time for them to be displayed on the screen. Wait for a while as the access lamp appears blinking, which indicates normal operation.

Digest Playback on a Blu-ray or DVD Player

You can play back a few seconds from each scene of the recorded videos in the created disc.

- 1 Load the created disc on a player.
- 2 Select "DIGEST PLAYBACK" on the TV.
 - The digest is played back continuously.

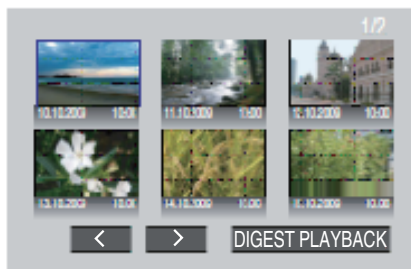

(The screen does not appear on this unit.)

Memo :

- To normal playback/To index menu
 - 1) Press the top menu button on the remote control of the player during digest playback.
 - 2) Select the desired item.
 - "DIGEST PLAYBACK" menu is not available when the DVD is created using the provided Everio MediaBrowser 3D software.
 - Digest Playback is not available when playing back by connecting this unit to a DVD writer or external Blu-ray drive.
 - Digest Playback is not available for MP4(MVC) videos recorded to discs.
-

Deleting Unwanted Files

Delete unwanted videos and still images when the space in the recording media is running out.

The remaining space in the recording media increases after deleting the files.

“Deleting the Currently Displayed File” (☞ p. 67)

“Deleting Selected Files” (☞ p. 67)

Memo :

- Deleted files cannot be restored.
- Files that are protected cannot be deleted.
Release protection before deleting the file.

“Protecting Files” (☞ p. 68)

- Be sure to back up important files on a PC.

“Backing Up All Files” (☞ p. 96)

Caution :

- Do not remove the recording medium or perform any other operation (such as turning off the power) while accessing files.
- Be sure to use the supplied JVC AC adapter.
- If the data on the recording medium becomes corrupted, format the recording medium to use the medium again.

“FORMAT SD CARD” (☞ p. 134)

Deleting the Currently Displayed File

Deletes the currently displayed file.

Caution :

- Deleted files cannot be restored.

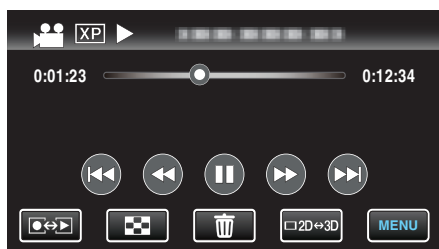

1 Tap .

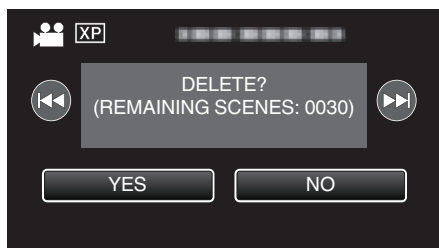

- While the video mode is shown in the image, the same operations apply for the still image mode.

2 Tap “YES”.



- Tap  /  to select the previous or next file.
- When no file remains, the screen returns to the index screen.

Memo :

- Files that are protected cannot be deleted.
Release protection before deleting the file.

“Protecting Files” (☞ p. 68)

Deleting Selected Files

Deletes the selected files.

Caution :

- Deleted files cannot be restored.

1 Select video or still image mode.

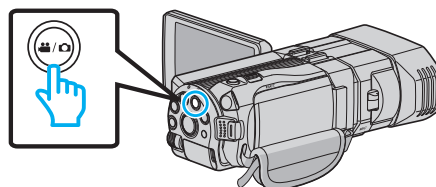

2 Tap  to select the playback mode.

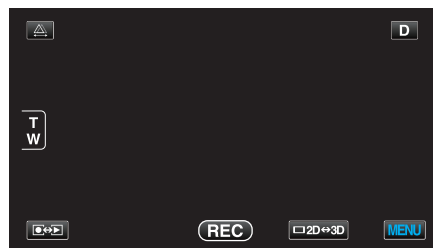

- While the video mode is shown in the image, the same operations apply for the still image mode.

3 Tap .



4 Tap on the files to delete.



- ✓ appears on the selected files.
To remove ✓ from a file, tap on the file again.
- Tap “SEL ALL” to select all files.
- Tap “REL ALL” to release all selections.
- Still images that are recorded continuously within 2 seconds or with the continuous shooting mode will be grouped together. Only the first recorded file is shown and the group is displayed with a green frame. When this is tapped, an index screen of the grouped files appears. Tap on the files to delete, then tap .

5 Tap “SET”.



6 Tap “EXECUTE” to confirm the deletion.

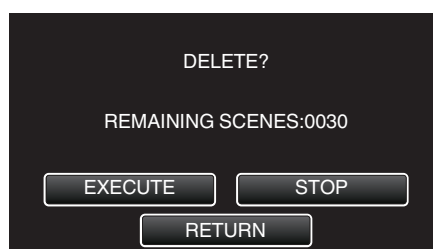

- After deleting is complete, tap “OK”.
- To cancel the deletion, tap “QUIT”.

Memo :

- Files that are protected cannot be deleted. Release protection before deleting the file.
- “Protecting Files” (p. 68)

Protecting Files

Prevent important videos/still images from being deleted accidentally by protecting them.

“Protecting/Releasing Protection of the Currently Displayed File” (p. 68)

“Protecting/Releasing Protection of Selected Files” (p. 68)

Caution :

- When the recording media is formatted, even the protected files will be deleted.

Protecting/Releasing Protection of the Currently Displayed File

Protects or releases protection of the currently displayed file.

- 1 Tap “MENU”.

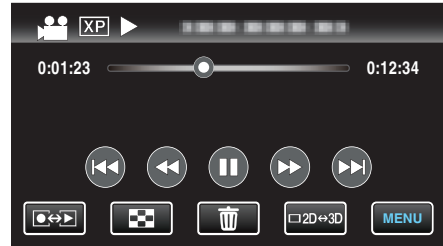

- 2 Tap “PROTECT/CANCEL”.

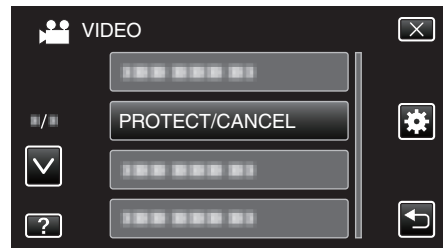

- 3 Tap “YES”.



- Tap ◀▶/▶▶ to select the previous or next file.
- After setting, tap “OK”.

Protecting/Releasing Protection of Selected Files

Protects or releases protection of the selected files.

- 1 Select video or still image mode.

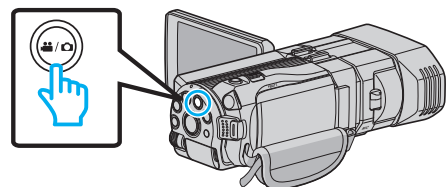

- 2 Tap ◻▶▶ to select the playback mode.

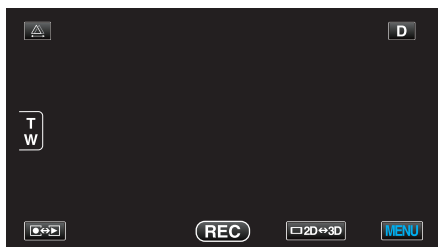

3 Tap "MENU".



4 Tap "PROTECT/CANCEL".

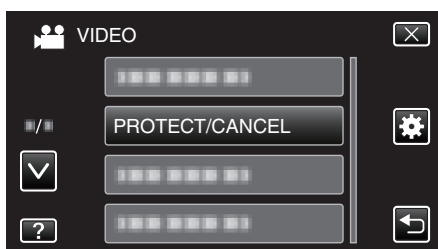

5 Tap on the files to protect or release protection of.



- and are displayed on the files that are already protected. To release protection of a file, tap on the file such that is removed.
- appears on the selected files. To remove from a file, tap on the file again.
- Tap "SEL ALL" to select all files.
- Tap "REL ALL" to release all selections.
- Still images that are recorded continuously within 2 seconds or with the continuous shooting mode will be grouped together. Only the first recorded file is shown and the group is displayed with a green frame. When this is tapped, an index screen of the grouped files appears. Tap on the files to protect or release protection of, then tap "".

6 Tap "SET".



- Protect marks appear on the selected files. Protect marks disappear from the deselected files.

Capturing a Still Image in the Video during Playback

You can capture still images of the scenes you like in the recorded videos.

1 Select video mode.

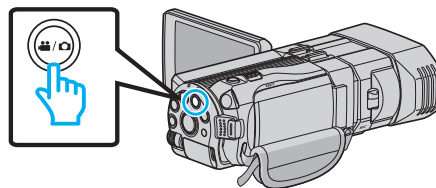

2 Tap to select the playback mode.

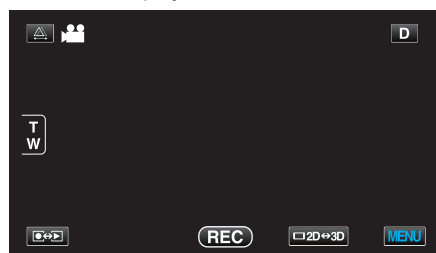

3 Tap on the desired video.



4 Tap pause at the desired scene during playback.

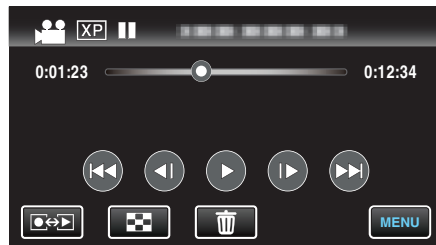

- After pausing the video, you can fine-tune the point to capture by tapping forward slow-motion and reverse slow-motion .

5 Press the SNAPSHOT button.

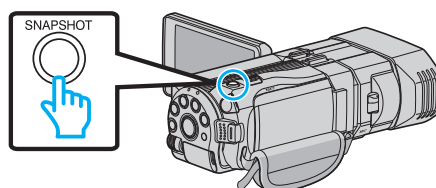

Memo :

- Still images are captured with a size of 1920x1080.
- Captured still images are stored in the media where the video is being played back from.
- Still images cannot be captured from 3D videos.

Capturing a Required Part in the Video (TRIMMING)

Select the required part of a video and save it as a new video file.

- The original video remains in its existing location.

1 Select video mode.

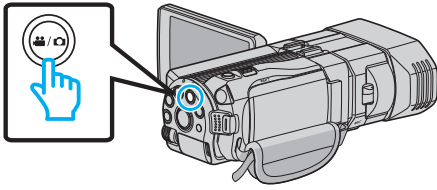

2 Tap to select the playback mode.

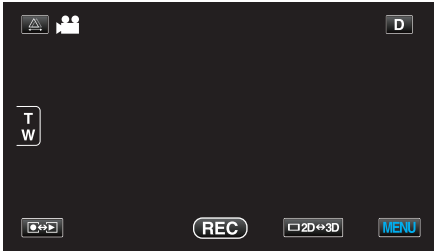

3 Tap "MENU".



4 Tap "TRIMMING".

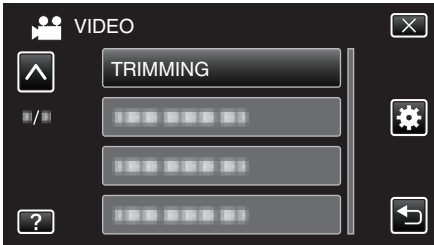

- Tap \wedge or \vee to move upward or downward for more selection.

5 Tap on the video to edit.



6 Tap to pause playback at the desired start point, then tap "A".

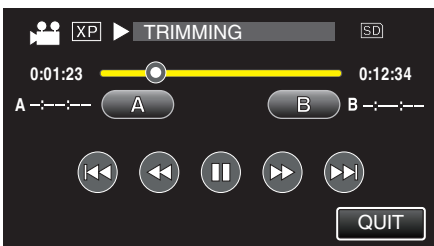

7 Tap to pause playback at the desired end point, then tap "B".

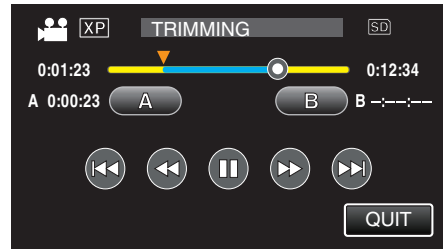

- To reset the start or end point, tap "A" or "B" at the desired scene (position).

8 Tap "SET".

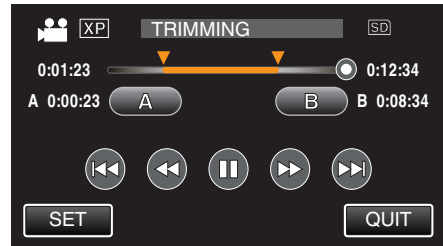

9 Tap "SET".



- When copying finishes, the copied file is added to the index screen.
- After copying, tap "OK".

Memo :

- The division point may deviate slightly from the selected scene.

Capturing Videos for Uploading to YouTube

Capture and copy a part of a recorded video (maximum 15 minutes) for uploading to YouTube, and save it as a YouTube video. When capturing videos for YouTube, the duration cannot be longer than 15 minutes.

- 1 Select video mode.

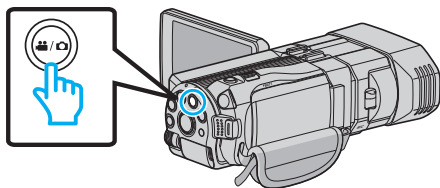

- 2 Tap to select the playback mode.

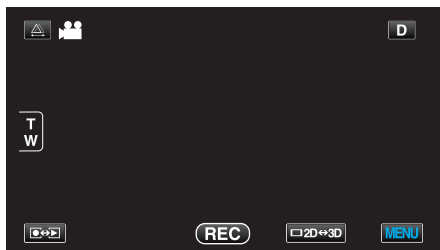

- 3 Tap "MENU".



- 4 Tap "UPLOAD SETTINGS".

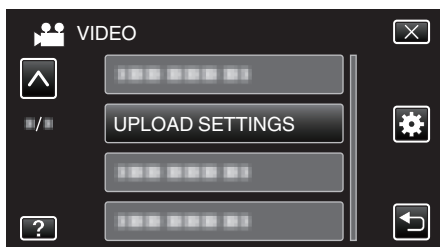

- Tap \wedge or \vee to move upward or downward for more selection.

- 5 Tap on the desired video.



- 6 Tap "TRIM".

- When trimming is not necessary, tap "DO NOT TRIM".

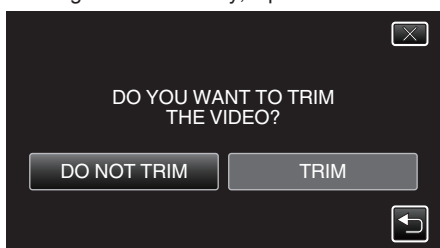

- If the selected video is more than 15 minutes, trimming is necessary.

- 7 Tap to pause playback at the desired start point, then tap "A".

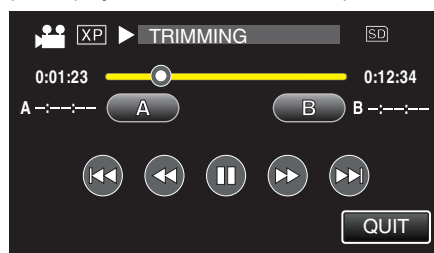

- 8 Tap to pause playback at the desired end point, then tap "B".

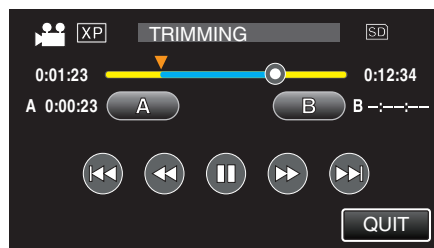

- To reset the start or end point, tap "A" or "B" at the desired scene (position).
- When capturing videos for YouTube, the duration cannot be longer than 15 minutes.

- 9 Tap "SET".

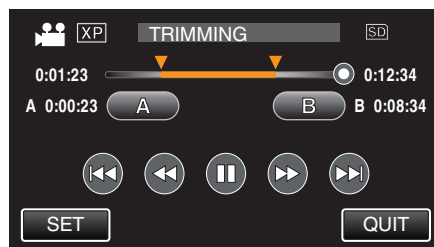

- 10 Tap "YES".

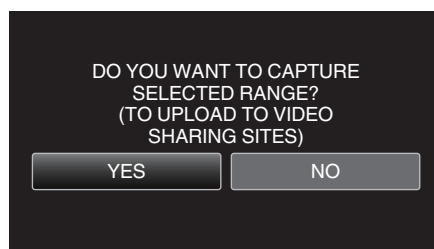

- After copying, tap "OK".
- When copying finishes, the copied file is added to the index screen.
- To exit upload settings, tap "STOP" on the upload settings screen.
- After copying, tap "OK".

Memo : _____

- The division point may deviate slightly from the selected scene.

Uploading Videos to YouTube

You can upload your videos to YouTube using the provided software Everio MediaBrowser 3D. Install the software on your PC and connect this unit to the PC.

- For details on how to use the software, refer to the help file.

"Installing the Provided Software" (p. 95)

"Connecting this Unit to PC" (p. 96)

Trouble with Uploading Videos : _____

- Check if you have created an account with YouTube. (You need a YouTube account to upload files to YouTube.)
- Refer to "Q&A", "Latest Information", "Download Information", etc. in "Click for Latest Product Info" in the help file of the provided software Everio MediaBrowser 3D.

Copying Files

You can create discs or copy the files on this unit by connecting it to various devices.

- Select the appropriate method of copying according to the device. If you are unsure about the method of copying, refer to “Copying Your Files”.

■ 3D (MP4(MVC)) Files

✓: Can be copied, -: Cannot be copied

Recording Device	DVD (AVCHD)	Blu-ray Disc	Device's Internal HDD
DVD writer connected to this unit “Creating Discs with a DVD Writer” (☞ p. 74)	-	-	-
External Blu-ray drive connected to this unit “Creating Discs with an External Blu-ray Drive” (☞ p. 80)	-	✓	-
Blu-ray recorder “Creating a Disc Using a Connected Blu-ray Recorder” (☞ p. 85)	-	-	-
DVD recorder “Dubbing Files by Connecting to a DVD Recorder” (☞ p. 86)	-	-	-
USB external hard disk drive “Using a USB External Hard Disk Drive” (☞ p. 86)	-	-	✓
Computer “Copying to Windows PC” (☞ p. 94)	-	-	*

*: When creating a disc with 3D images, there may be certain limitations due to the recording format. Refer to the help file of the provided Everio MediaBrowser 3D software to operate.

Memo :

- 3D images cannot be copied to a VHS tape.
- Videos recorded in MP4(MVC) format can be copied or played back only when dubbed to a Blu-ray disc or hard disk drive.
Copy or play back by connecting this unit to an external Blu-ray drive or USB external hard disk drive.

■ 3D (AVCHD) Files

✓: Can be copied, -: Cannot be copied

Recording Device	DVD (AVCHD)	Blu-ray Disc	Device's Internal HDD
DVD writer connected to this unit “Creating Discs with a DVD Writer” (☞ p. 74)	✓	-	-
External Blu-ray drive connected to this unit “Creating Discs with an External Blu-ray Drive” (☞ p. 80)	✓	✓	-
Blu-ray recorder “Creating a Disc Using a Connected Blu-ray Recorder” (☞ p. 85)	-	✓*1	✓
DVD recorder “Dubbing Files by Connecting to a DVD Recorder” (☞ p. 86)	-	-	✓
USB external hard disk drive “Using a USB External Hard Disk Drive” (☞ p. 86)	-	-	✓
Computer “Copying to Windows PC” (☞ p. 94)	*2	*2	*2

*1: Only on AVCHD compatible devices.

*2: When creating a disc with 3D images, there may be certain limitations due to the recording format. Refer to the help file of the provided Everio MediaBrowser 3D software to operate.

Memo :

- When AVCHD files recorded in 3D are played back on a normal recorder or player, the left and right images will be displayed separately.
- 3D images cannot be copied to a VHS tape. Copy them to a Blu-ray disc, DVD, or USB external hard disk drive.
- To record to discs with a computer, a recordable DVD or Blu-ray drive is required for the computer in use.

■ 2D Files

✓: Can be copied, -: Cannot be copied

Recording Device	VHS Tape	DVD (DVD-Video)	DVD (AVCHD)	Blu-ray Disc	Device's Internal HDD
DVD writer connected to this unit "Creating Discs with a DVD Writer" (☞ p. 74)	-	✓	✓	-	-
External Blu-ray drive connected to this unit "Creating Discs with an External Blu-ray Drive" (☞ p. 80)	-	✓	✓	✓	-
Blu-ray recorder "Creating a Disc Using a Connected Blu-ray Recorder" (☞ p. 85)	-	✓	-	✓*1	✓
DVD recorder "Dubbing Files by Connecting to a DVD Recorder" (☞ p. 86)	-	✓	-	-	✓
USB external hard disk drive "Using a USB External Hard Disk Drive" (☞ p. 86)	-	-	-	-	✓
VCR "Dubbing Files to a VHS Tape Using a VCR" (☞ p. 91)	✓	-	-	-	-
Computer "Copying to Windows PC" (☞ p. 94)	-	*2	*2	*2	✓

*1: Only on AVCHD compatible devices.

*2: Use Everio MediaBrowser 3D to record to discs on the computer. Refer to the help file of the provided Everio MediaBrowser 3D software to operate.

Memo :

- To record to discs with a computer, a recordable DVD or Blu-ray drive is required for the computer in use.

For customers who completed the firmware update

■ Files recorded in 3D (AVCHD 3D) mode

✓: Can be copied, -: Cannot be copied

Recording Device	DVD (AVCHD)	Blu-ray Disc	Device's Internal HDD
DVD writer connected to this unit "Creating Discs with a DVD Writer" (☞ p. 74)	-	-	-
External Blu-ray drive connected to this unit "Creating Discs with an External Blu-ray Drive" (☞ p. 80)	-	✓	-
Blu-ray recorder "Creating a Disc Using a Connected Blu-ray Recorder" (☞ p. 85)	-	✓*1	✓*1
DVD recorder "Dubbing Files by Connecting to a DVD Recorder" (☞ p. 86)	-	-	-
USB external hard disk drive "Using a USB External Hard Disk Drive" (☞ p. 86)	-	-	✓
Computer "Copying to Windows PC" (☞ p. 94)	-	*2	*2

*1: only on AVCHD 3D compatible devices

*2: When creating a disc with 3D images, there may be certain limitations due to the recording format. Refer to the help file of the provided Everio MediaBrowser 3D software to operate.

Memo :

- 3D images cannot be copied to a VHS tape.
- When dubbing the videos recorded in AVCHD 3D format by using the USB external hard disk drive, connect the USB external hard disk drive to this unit.
- To record to discs with a computer, a recordable DVD or Blu-ray drive is required for the computer in use.

Creating Discs with a DVD Writer

You can copy the recorded files to discs or play back the created discs using an optional DVD writer.

Compatible DVD Writers

Product Name	Description
DVD Writer • CU-VD3	<ul style="list-style-type: none"> Enables the images recorded on this unit to be copied to a DVD without using a PC.
DVD Writer • CU-VD50	<ul style="list-style-type: none"> Creates DVDs and functions as an external DVD drive when connected to a PC. In addition, created DVDs can be played back by connecting the CU-VD50 to a TV.

Creating Discs with a DVD Writer

■ Preparing a DVD Writer

“Preparing a DVD Writer (CU-VD50)” (p. 75)

“Preparing a DVD Writer (CU-VD3)” (p. 75)

■ Copying to Discs

“Copying All Files” (p. 75)

“Copying Files by Date (2D mode only)” (p. 76)

“Copying Selected Files” (p. 78)

■ Other Operations

“Playing Back with a DVD Writer” (p. 79)

“Finalizing Discs After Copying” (p. 80)

Memo :

- When there are many files to back up, it may take time for the backup to be completed. Wait for a while as the access lamp appears blinking, which indicates normal operation.
- Recording date and time will not be displayed when playing back a disc that contains videos recorded in 3D mode.

Caution :

- 3D images in MP4(MVC) format cannot be copied to a DVD writer.

Changing the Media of the DVD Writer

Set the type of media according to the loaded DVD.

1 Prepare a DVD writer.

“Preparing a DVD Writer (CU-VD50)” (p. 75)

“Preparing a DVD Writer (CU-VD3)” (p. 75)

2 Tap “CHANGE REC. MEDIA” in the “BACK-UP” menu.

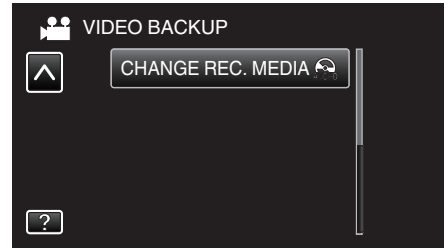

3 Tap “DVD(AVCHD)” or “DVD-Video”.

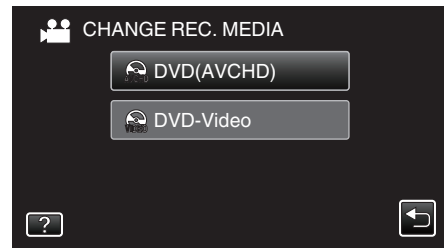

- The media changes to the tapped item. Select the appropriate setting according to the disc.
- Selecting “DVD(AVCHD)” enables you to save videos in a DVD in the high definition quality.
- Selecting “DVD-Video” enables you to save videos in a DVD after converting to the standard image quality.

Caution :

- When copying 3D images in AVCHD format, the media of the DVD writer cannot be changed.

For customers who completed the firmware update:

- When copying 3D images in AVCHD 3D format, the media of the DVD writer cannot be changed.

Preparing a DVD Writer (CU-VD50)

- 1 Connect the USB cable and the AC adapter.
 - Turn off the camcorder by pressing the  button for about 2 seconds.

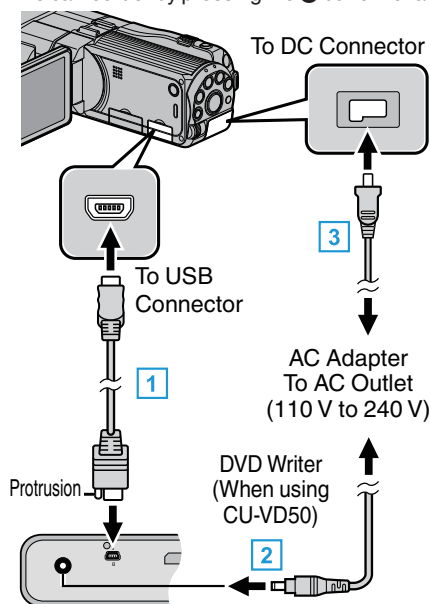

- 1 Connect the USB cable provided with the DVD writer.
- 2 Connect the AC adapter of the DVD writer.
- 3 Connect the AC adapter to this unit.
 - This unit powers on automatically when the AC adapter is connected.
 - This unit turns on and the "BACK-UP" menu appears.
 - While the USB cable is connected, the "BACK-UP" menu is displayed.
 - Refer also to the instruction manual of the DVD writer.

- 2 Turn on the DVD writer and insert a new disc.

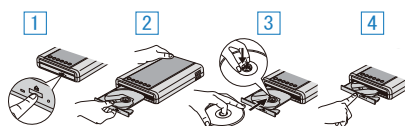

- 1 Press the power button to turn on the power.
- 2 Press the eject button to open the disc tray.
- 3 Pull out the tray completely and load a new disc properly.
- 4 Push the disc tray in until it clicks into place.

Caution :

- Be sure to turn off the power when connecting the devices. Otherwise, electric shocks or malfunctions may occur.

Memo :

- When connected to this unit, all buttons on the DVD writer CU-VD50, other than the power and eject buttons, will not work.

Preparing a DVD Writer (CU-VD3)

- 1 Connect the USB cable and the AC adapter.
 - Turn off the camcorder by pressing the  button for about 2 seconds.

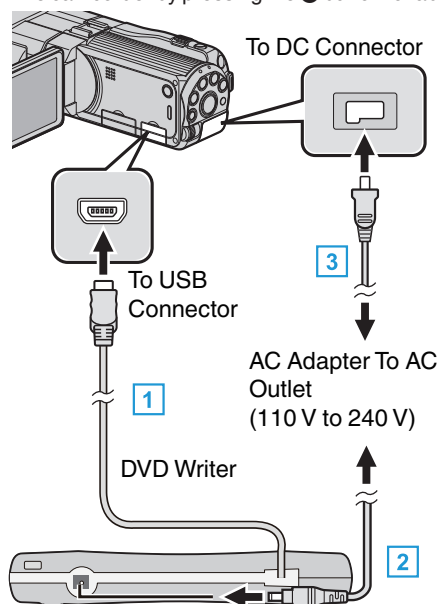

- 1 Connect the USB cable of the DVD writer to this unit.
- 2 Connect the AC adapter of the DVD writer.
- 3 Connect the AC adapter to this unit.
 - This unit powers on automatically when the AC adapter is connected.
 - This unit turns on and the "BACK-UP" menu appears.
 - While the USB cable is connected, the "BACK-UP" menu is displayed.
 - Refer also to the instruction manual of the DVD writer.

- 2 Insert a new disc.

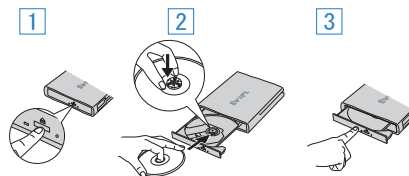

- 1 Press the eject button to open the disc tray.
- 2 Pull out the tray completely and load a new disc properly.
- 3 Push the disc tray in until it clicks into place.

Caution :

- Be sure to turn off the power when connecting the devices. Otherwise, electric shocks or malfunctions may occur.

Creating a Disc

- 1 Prepare a DVD writer.
 - Insert a new disc into the DVD writer.
 - “Preparing a DVD Writer (CU-VD50)” (p. 75)
 - “Preparing a DVD Writer (CU-VD3)” (p. 75)
- 2 Copy files to the disc with the following methods.
 - “Copying All Files” (p. 75)
 - “Copying Files by Date (2D mode only)” (p. 76)
 - “Copying Selected Files” (p. 78)

Copying All Files

All videos or still images recorded on this unit will be copied. You can also select and copy only the videos or still images that have never been copied.

- 1 Select 3D or 2D mode.

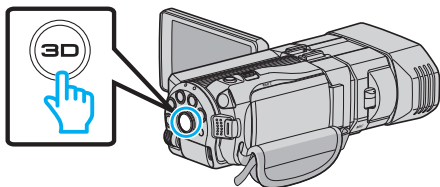

2 Select video or still image mode.

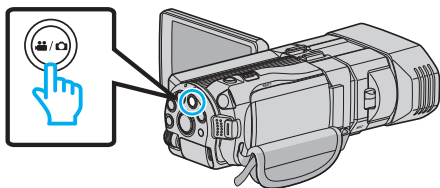

3 Tap "CREATE FROM ALL" (video) or "SAVE ALL" (still image).

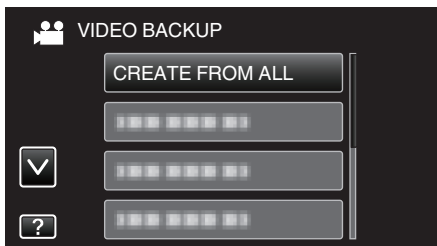

- While the video mode is shown in the image, the same operations apply for the still image mode.

4 Tap on the media to copy.

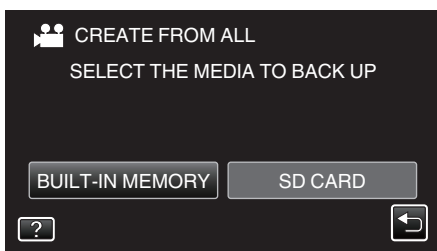

5 Tap the desired method.

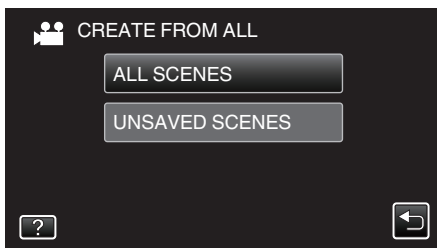

- While the video mode is shown in the image, the same operations apply for the still image mode.
- **"ALL SCENES" (video)/"ALL IMAGES" (still image):**
All videos or still images in this unit are copied.
- **"UNSAVED SCENES" (video)/"UNSAVED IMAGES" (still image):**
Videos or still images that have never been copied are automatically selected and copied.

6 Tap "EXECUTE".

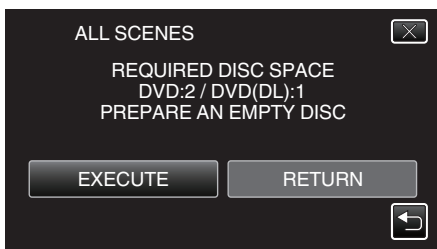

- The number of discs required to copy the files is displayed. Prepare the discs accordingly.

7 Tap "YES" or "NO". (3D mode only)

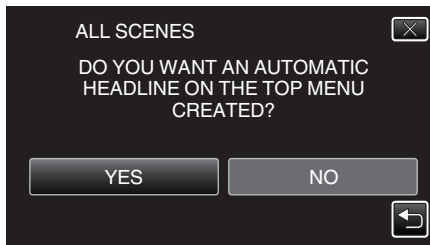

- When "YES" is selected, videos with similar recording dates are displayed in groups.
- When "NO" is selected, videos are displayed according to recording dates.

8 Tap "EXECUTE".

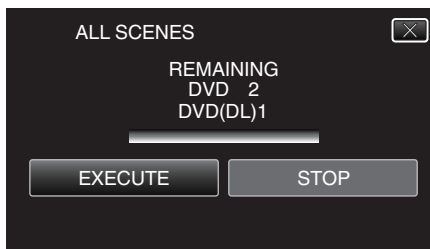

- When "INSERT NEXT DISC" appears, change the disc.

9 After copying, tap "OK".

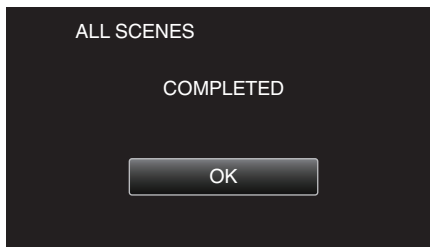

10 Press and hold the **Power** button for 2 seconds or more to turn off this unit and disconnect the USB cable.

Caution :

- Do not turn off the power or remove the USB cable until copying is complete.
- Files that are not on the index screen during playback cannot be copied.

Memo :

- To check the created disc, refer to "Playing Back with a DVD Writer". "Playing Back with a DVD Writer" (p. 79)

When "DO YOU WANT TO FINALIZE?" appears

This appears when "AUTO FINALIZE" in the basic settings menu is set to OFF.

"AUTO FINALIZE" (p. 133)

- To play back on other devices, tap "YES".
- To add more files to the DVD later, tap "NO".

Memo :

- When two or more DVDs are created simultaneously, all the discs other than the last one will be finalized automatically even when "AUTO FINALIZE" is set to "OFF".
- You can finalize a DVD even when "FINALIZE" is selected in the "BACK-UP" menu.
"Finalizing Discs After Copying" (p. 80)
- To play back a BD-R disc on other devices, select "FINALIZE" after creating the disc.
(The "AUTO FINALIZE" function on the basic settings menu can only be used for creating DVDs.)

Copying Files by Date (2D mode only)

Videos or still images are sorted and copied according to the date on which they were recorded.

- Only 2D videos or still images can be sorted and copied according to the date on which they were recorded.

1 Select 2D mode.

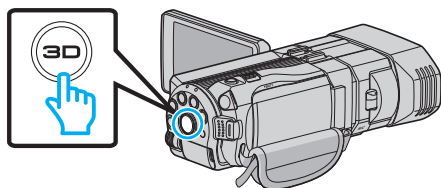

2 Select video or still image mode.

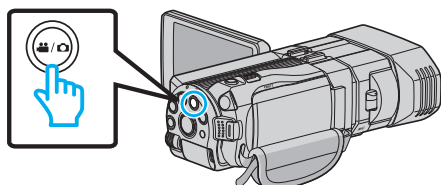

3 Tap "SELECT AND CREATE" (video) or "SELECT AND SAVE" (still image).

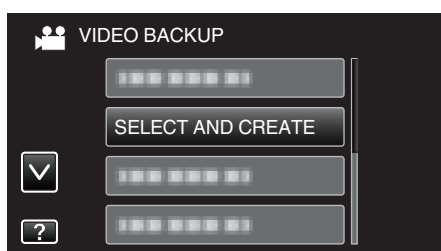

- While the video mode is shown in the image, the same operations apply for the still image mode.

4 Tap on the media to copy.

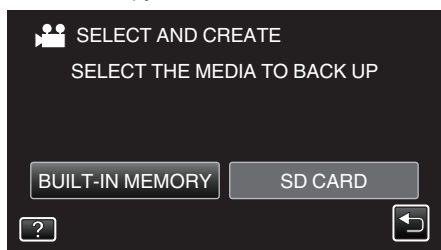

5 Tap "CREATE BY DATE" (video) or "SAVE BY DATE" (still image).

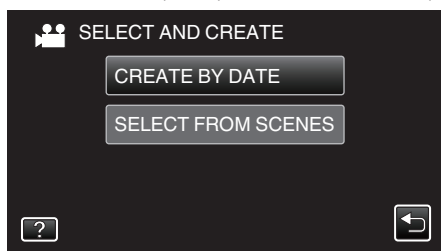

- While the video mode is shown in the image, the same operations apply for the still image mode.

6 Tap to select a recording date.

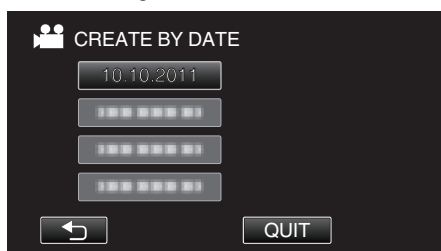

7 Tap "EXECUTE".

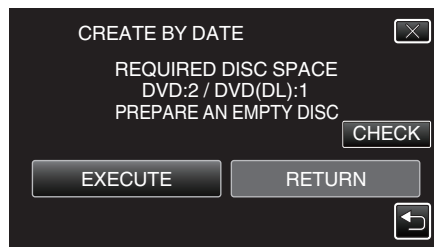

- The number of discs required to copy the files is displayed. Prepare the discs accordingly.

8 Tap "YES" or "NO". (👤 mode only)



- When "YES" is selected, videos with similar recording dates are displayed in groups.
- When "NO" is selected, videos are displayed according to recording dates.

9 Tap "EXECUTE".

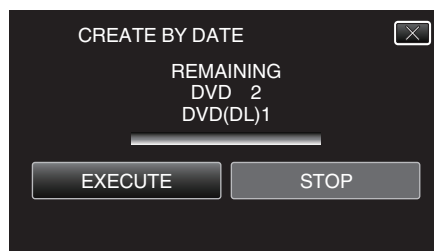

- When "INSERT NEXT DISC" appears, change the disc.

10 After copying, tap "OK".

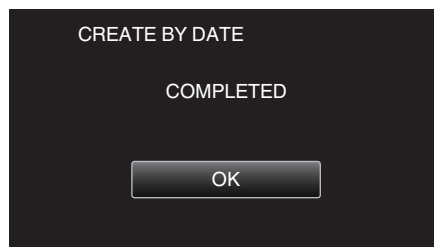

11 Press and hold the button for 2 seconds or more to turn off this unit and disconnect the USB cable.

Caution :

- Do not turn off the power or remove the USB cable until copying is complete.
- Files that are not on the index screen during playback cannot be copied.
- 3D videos cannot be copied.

Memo :

- To check the created disc, refer to "Playing Back with a DVD Writer". "Playing Back with a DVD Writer" (p. 79)

When "DO YOU WANT TO FINALIZE?" appears

This appears when "AUTO FINALIZE" in the basic settings menu is set to OFF.

"AUTO FINALIZE" (p. 133)

- To play back on other devices, tap "YES".
- To add more files to the DVD later, tap "NO".

Memo :

Copying

- When two or more DVDs are created simultaneously, all the discs other than the last one will be finalized automatically even when "AUTO FINALIZE" is set to "OFF".
 - You can finalize a DVD even when "FINALIZE" is selected in the "BACK-UP" menu.
- "Finalizing Discs After Copying" (p. 80)
- To play back a BD-R disc on other devices, select "FINALIZE" after creating the disc.
(The "AUTO FINALIZE" function on the basic settings menu can only be used for creating DVDs.)

Copying Selected Files

Select and copy the desired videos or still images individually.

- 1 Select 3D or 2D mode.

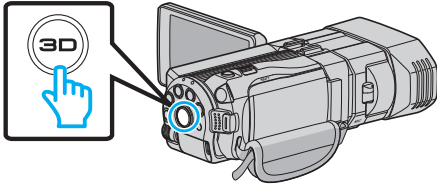

- 2 Select video or still image mode.

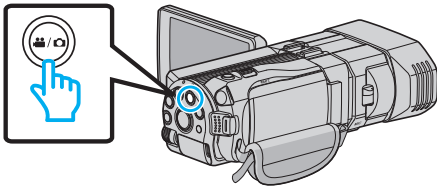

- 3 Tap "SELECT AND CREATE" (video) or "SELECT AND SAVE" (still image).

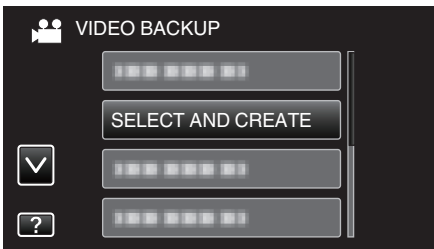

- While the video mode is shown in the image, the same operations apply for the still image mode.

- 4 Tap on the media to copy.

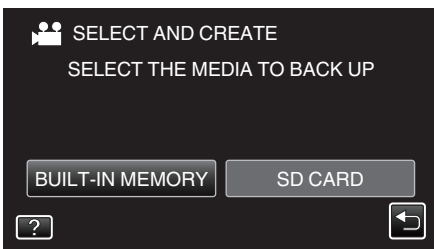

- 5 Tap "SELECT FROM SCENES" (video) or "SELECT FROM IMAGES" (still image).

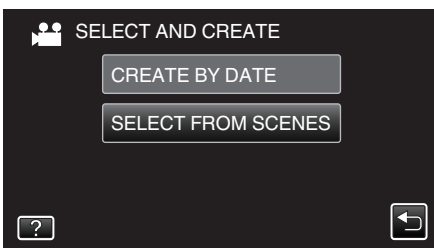

- While the video mode is shown in the image, the same operations apply for the still image mode.

- 6 Tap on the videos or still images to copy.

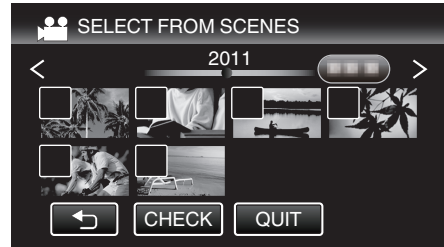

- A check mark appears on the selected file.
To remove the check mark, tap on the file again.
- Tap "CHECK" to check the file.
- While the video mode is shown in the image, the same operations apply for the still image mode.

- 7 After selecting all the files, tap "SAVE".

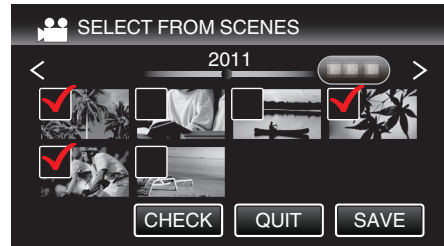

- While the video mode is shown in the image, the same operations apply for the still image mode.

- 8 Tap "EXECUTE".



- The number of discs required to copy the files is displayed.
Prepare the discs accordingly.

- 9 Tap "YES" or "NO". (mode only)

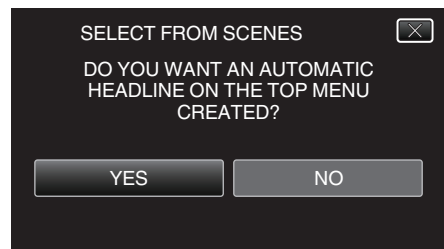

- When "YES" is selected, videos with similar recording dates are displayed in groups.
- When "NO" is selected, videos are displayed according to recording dates.

- 10 Tap "EXECUTE".



- When "INSERT NEXT DISC" appears, change the disc.

- 11 After copying, tap "OK".

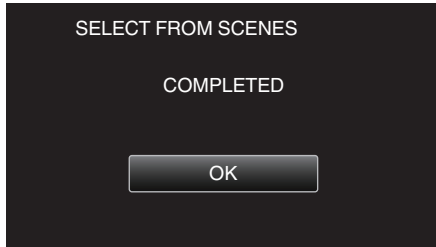

12 Press and hold the button for 2 seconds or more to turn off this unit and disconnect the USB cable.

Caution :

- Do not turn off the power or remove the USB cable until copying is complete.
- Files that are not on the index screen during playback cannot be copied.

Memo :

- To check the created disc, refer to “Playing Back with a DVD Writer”. “Playing Back with a DVD Writer” (p. 79)

When “DO YOU WANT TO FINALIZE?” appears

This appears when “AUTO FINALIZE” in the basic settings menu is set to OFF.

“AUTO FINALIZE” (p. 133)

- To play back on other devices, tap “YES”.
- To add more files to the DVD later, tap “NO”.

Memo :

- When two or more DVDs are created simultaneously, all the discs other than the last one will be finalized automatically even when “AUTO FINALIZE” is set to “OFF”.
- You can finalize a DVD even when “FINALIZE” is selected in the “BACK-UP” menu.

“Finalizing Discs After Copying” (p. 80)

- To play back a BD-R disc on other devices, select “FINALIZE” after creating the disc. (The “AUTO FINALIZE” function on the basic settings menu can only be used for creating DVDs.)

Playing Back with a DVD Writer

You can play back the DVDs created on this unit.

1 Prepare a DVD writer.

- Insert the DVD to play back into the DVD writer. “Preparing a DVD Writer (CU-VD50)” (p. 75) “Preparing a DVD Writer (CU-VD3)” (p. 75)

2 Tap “PLAYBACK” in the BACK-UP menu.

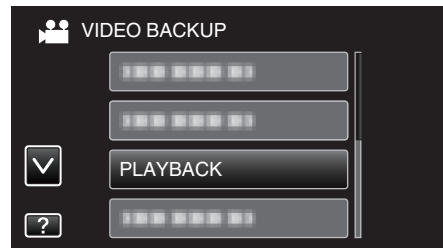

- An index screen (thumbnail display) of the videos in the disc appears.
- Tap “←” to return to the “BACK-UP” menu.
- Images recorded in 3D mode and 2D mode are displayed on the index screen separately. Press the 3D button to switch to the desired mode for playback.
- During 3D mode, “3D” is displayed on the LCD monitor.
- During 2D mode, “2D” is displayed on the LCD monitor.

3 Tap on the file to start playback.



- For details on video playback, refer to ““Operation Buttons for Video Playback” (p. 54) ”.
- “Operation Buttons for Video Playback” (p. 54)
- To exit, stop playback and turn off the camcorder by pressing the button for about 2 seconds. Then, disconnect the USB cable.

Memo :

- 3D images may be played back when the 3D button lights up.
- It is recommended to play back in stop-motion for scenes that are likely to cause motion sickness during 3D playback.
- By default, “3D MOTION RELIEF” is set to “ON”. Scenes that are likely to cause motion sickness during 3D playback may be played back in stop-motion, but this is not a malfunction. To play back normally, set “3D MOTION RELIEF” to “OFF”.

“3D MOTION RELIEF (3D mode only)” (p. 120)

Copying

- When playing back a disc created in DVD-Video format, no information such as date and time will be displayed.

Finalizing Discs After Copying

Finalize the disc after copying is finished. This enables the disc to be played back using this unit, PC, DVD writer, DVD player, or external Blu-ray drive that supports the BD-MV and AVCHD formats.

- 1 Select video or still image mode.

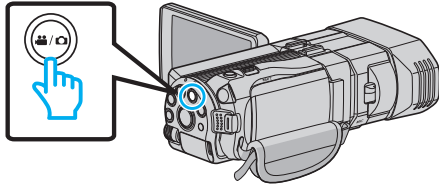

- 2 Tap "FINALIZE".

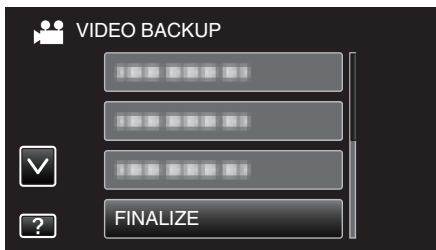

- 3 Tap "YES".

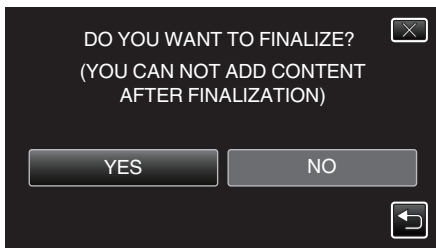

- After finalizing, tap "OK".

Creating Discs with an External Blu-ray Drive

You can copy the recorded files to discs or play back the created discs using an optional external Blu-ray drive.

Compatible External Blu-ray Drives

You can use BE08LU20 from LG. (as of December, 2010)

Creating Discs with an External Blu-ray Drive

■ Preparing an External Blu-ray Drive

"Preparing an External Blu-ray Drive" (p. 81)

■ Copying to Discs

"Copying All Files" (p. 81)

"Copying Files by Date (2D mode only)" (p. 82)

"Copying Selected Files" (p. 83)

■ Other Operations

"Playing Back with an External Blu-ray Drive" (p. 84)

Memo :

- Discs that are recorded in MP4(MVC) format cannot be played back on AVCHD compatible Blu-ray recorders. Play it back on an external Blu-ray drive.
- "Playing Back with an External Blu-ray Drive" (p. 84)
- The recordable time on the disc varies according to the way of recording.
- When there are many files to back up, it may take time for the backup to be completed. Wait for a while as the access lamp appears blinking, which indicates normal operation.
- Recording date and time will not be displayed when playing back a disc that contains videos recorded in 3D mode.

For customers who completed the firmware update: _____

- Discs recorded in AVCHD 3D format cannot be played back with the Blu-ray recorder which is not compatible with AVCHD 3D. Play back the discs on an external Blu-ray drive.

"Playing Back with an External Blu-ray Drive" (p. 84)

Changing the Media of the External Blu-ray Drive

Set the type of media according to the loaded Blu-ray disc or DVD.

- 1 Prepare an external Blu-ray drive.

- Insert a disc into the external Blu-ray drive.

"Preparing an External Blu-ray Drive" (p. 81)

- 2 Tap "CHANGE REC. MEDIA" in the "BACK-UP" menu.

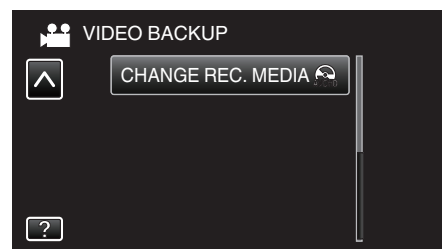

- 3 Tap "Blu-ray DISC", "DVD(AVCHD)", or "DVD-Video".

- The media changes to the tapped item. Select the appropriate setting according to the disc.
- Selecting "Blu-ray DISC" enables you to save videos in a Blu-ray disc in the high definition quality.
- Selecting "DVD(AVCHD)" enables you to save videos in a DVD in the high definition quality.
- Selecting "DVD-Video" enables you to save videos in a DVD after converting to the standard image quality.

Caution :

- "DVD-Video" cannot be selected when saving a video in AVCHD (3D) mode.
- Media cannot be changed when saving MP4(MVC) videos. (Only recordable to BD)

For customers who completed the firmware update: _____

- When saving a video in AVCHD 3D mode, the modes cannot be switched. (Only recordable to BD)

Preparing an External Blu-ray Drive

Memo :

When connecting to the external Blu-ray drive, use a USB cable with Mini-A (Male) – B (Male) connectors.

The USB cable provided with this unit cannot be used.

- To use the USB cable provided with the external Blu-ray drive, purchase the USB extension cable.

Mini-A (Male) – A (Female)

(Part number: QAM0852-001)

1 Connect the USB cable and the AC adapter.

- Turn off the camcorder by pressing the  button for about 2 seconds.

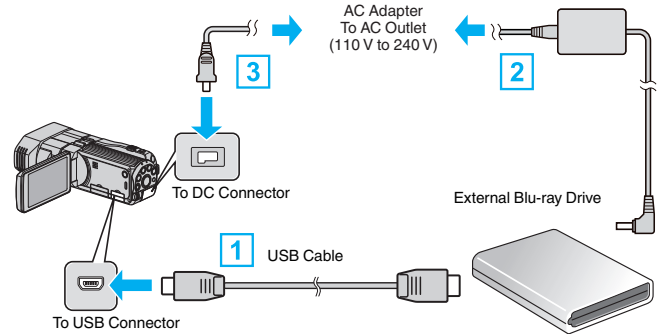

1 Connect the USB cable of the external Blu-ray drive to this unit.

2 Connect the AC adapter of the external Blu-ray drive.

3 Connect the AC adapter to this unit.

- This unit powers on automatically when the AC adapter is connected.
- This unit turns on and the “BACK-UP” menu appears.
- While the USB cable is connected, the “BACK-UP” menu is displayed.
- Refer also to the instruction manual of the external Blu-ray drive.

2 Insert a new disc.

- Press the power button on the external Blu-ray drive to turn on the power.



1 Press the eject button to open the disc tray.

2 Pull out the tray completely and load a new disc properly.

3 Push the disc tray in until it clicks into place.

Caution :

- Be sure to turn off the power when connecting the devices. Otherwise, electric shocks or malfunctions may occur.

Creating a Disc

Creating a Disc

1 Prepare an external Blu-ray drive.

- Insert a new disc into the external Blu-ray drive. “Preparing an External Blu-ray Drive” (p. 81)

2 Copy files to the disc with the following methods.

- “Copying All Files” (p. 81)
- “Copying Files by Date (2D mode only)” (p. 82)
- “Copying Selected Files” (p. 83)

Copying All Files

All videos or still images recorded on this unit will be copied. You can also select and copy only the videos or still images that have never been copied.

1 Select 3D or 2D mode.

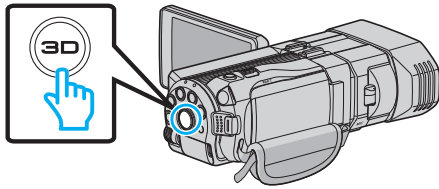

2 Select video or still image mode.

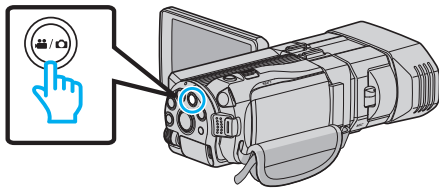

3 Tap "CREATE FROM ALL" (video) or "SAVE ALL" (still image).

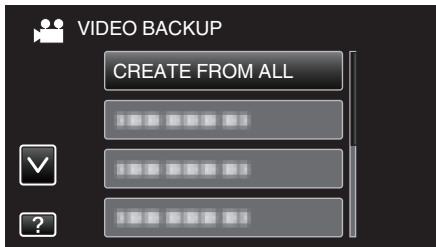

4 Tap on the media to copy.

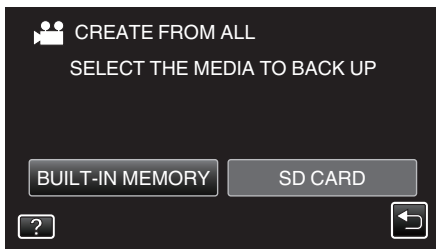

5 Tap the desired method.

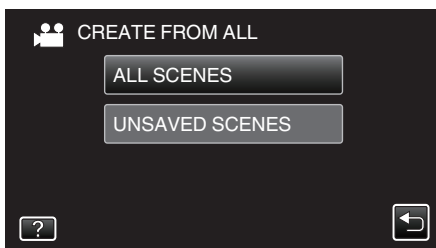

• **"ALL SCENES" (video)/"ALL IMAGES" (still image):**

All videos or still images in this unit are copied.

• **"UNSAVED SCENES" (video)/"UNSAVED IMAGES" (still image):**

Videos or still images that have never been copied are automatically selected and copied.

6 Tap "EXECUTE".

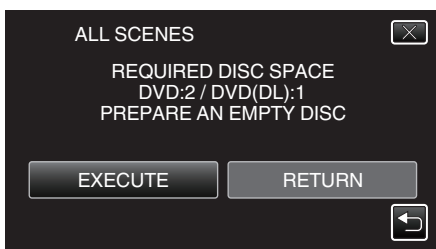

• The number of discs required to copy the files is displayed. Prepare the discs accordingly.

7 Tap "YES" or "NO". (M mode only)

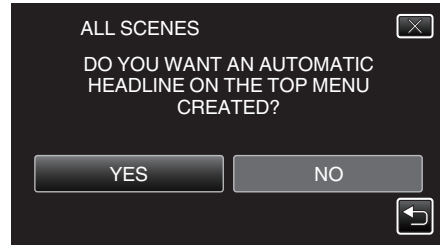

- When "YES" is selected, videos with similar recording dates are displayed in groups.
- When "NO" is selected, videos are displayed according to recording dates.

8 Tap "EXECUTE".

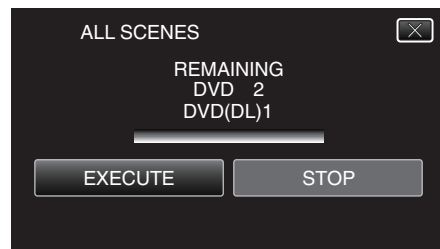

- When "INSERT NEXT DISC" appears, change the disc.

9 After copying, tap "OK".

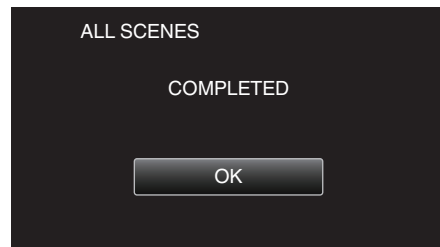

10 Press and hold the **power** button for 2 seconds or more to turn off this unit and disconnect the USB cable.

Caution :

- Do not turn off the power or remove the USB cable until copying is complete.
- Files that are not on the index screen during playback cannot be copied.

Memo :

- To check the created disc, refer to "Playing Back with an External Blu-ray Drive".

"Playing Back with an External Blu-ray Drive" (p. 84)

Copying Files by Date (2D mode only)

Videos or still images are sorted and copied according to the date on which they were recorded.

1 Select 3D or 2D mode.

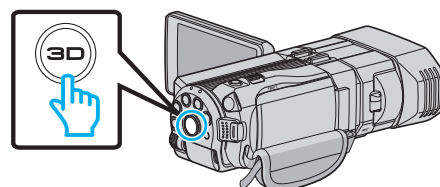

2 Select video or still image mode.

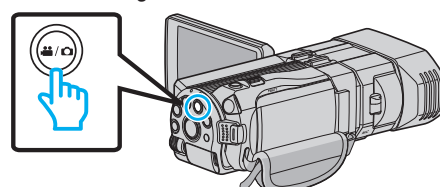

3 Tap "SELECT AND CREATE" (video) or "SELECT AND SAVE" (still image).

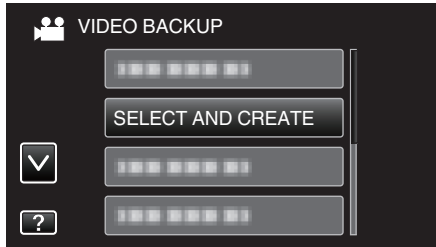

- While the video mode is shown in the image, the same operations apply for the still image mode.

4 Tap on the media to copy.

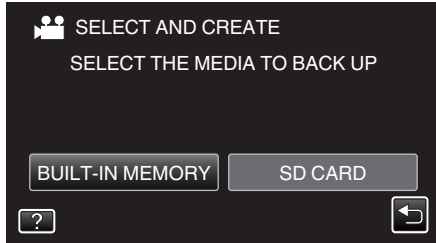

5 Tap "CREATE BY DATE" (video) or "SAVE BY DATE" (still image).

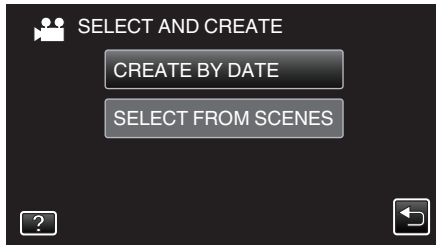

- While the video mode is shown in the image, the same operations apply for the still image mode.

6 Tap to select a recording date.



7 Tap "EXECUTE".



- The number of discs required to copy the files is displayed. Prepare the discs accordingly.

8 Tap "YES" or "NO". (👤 mode only)



- When "YES" is selected, videos with similar recording dates are displayed in groups.
- When "NO" is selected, videos are displayed according to recording dates.

9 Tap "EXECUTE".

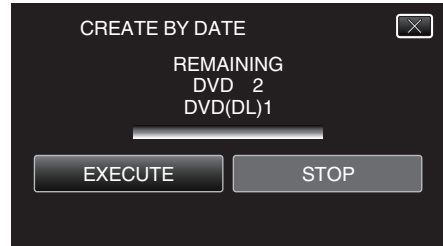

- When "INSERT NEXT DISC" appears, change the disc.

10 After copying, tap "OK".

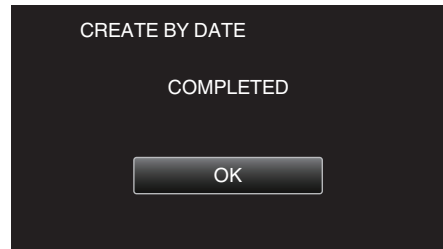

11 Press and hold the button for 2 seconds or more to turn off this unit and disconnect the USB cable.

Caution :

- Do not turn off the power or remove the USB cable until copying is complete.
- Files that are not on the index screen during playback cannot be copied.
- 3D videos cannot be copied.

Memo :

- To check the created disc, refer to "Playing Back with an External Blu-ray Drive".

"Playing Back with an External Blu-ray Drive" (p. 84)

Copying Selected Files

Select and copy the desired videos or still images individually.

1 Select 3D or 2D mode.

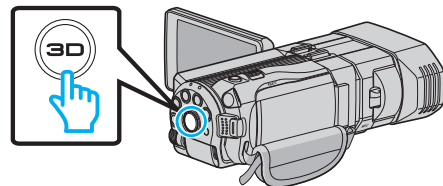

2 Select video or still image mode.

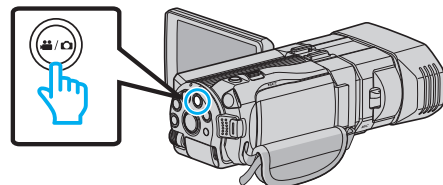

- 3 Tap "SELECT AND CREATE" (video) or "SELECT AND SAVE" (still image).

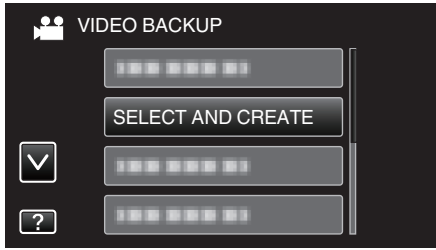

- 4 Tap on the media to copy.

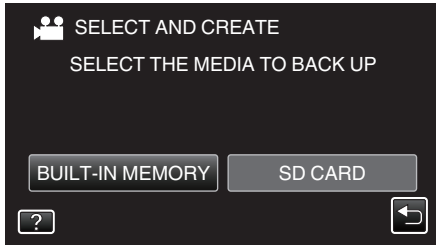

- 5 Tap "SELECT FROM SCENES" (video) or "SELECT FROM IMAGES" (still image).

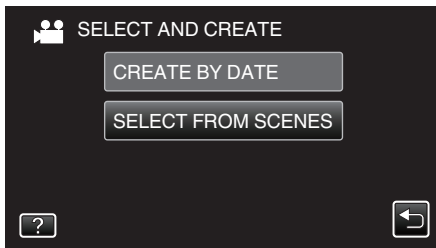

- While the video mode is shown in the image, the same operations apply for the still image mode.

- 6 Tap on the videos or still images to copy.

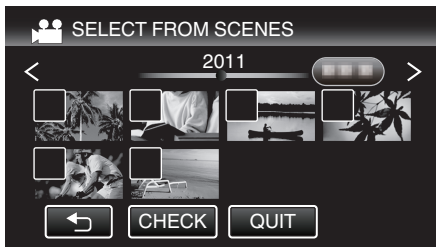

- A check mark appears on the selected file. To remove the check mark, tap on the file again.
- Tap "CHECK" to check the file.

- 7 After selecting all the files, tap "SAVE".

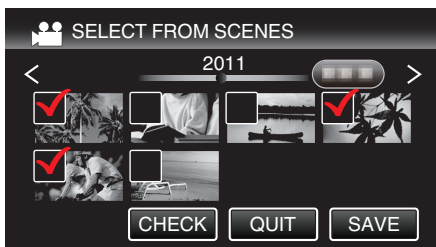

- 8 Tap "EXECUTE".



- The number of discs required to copy the files is displayed. Prepare the discs accordingly.

- 9 Tap "YES" or "NO". (👤 mode only)

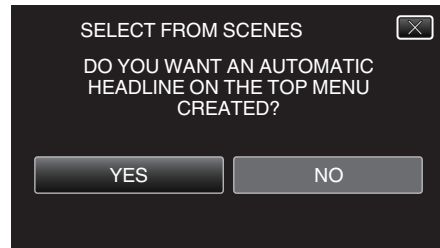

- When "YES" is selected, videos with similar recording dates are displayed in groups.
- When "NO" is selected, videos are displayed according to recording dates.

- 10 Tap "EXECUTE".



- When "INSERT NEXT DISC" appears, change the disc.

- 11 After copying, tap "OK".

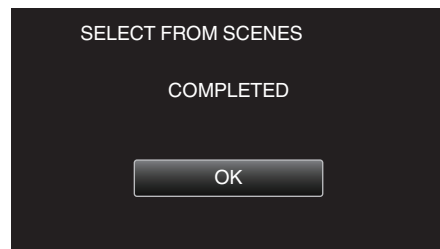

- 12 Press and hold the ⏻ button for 2 seconds or more to turn off this unit and disconnect the USB cable.

Caution :

- Do not turn off the power or remove the USB cable until copying is complete.
- Files that are not on the index screen during playback cannot be copied.

Memo :

- To check the created disc, refer to "Playing Back with an External Blu-ray Drive".

"Playing Back with an External Blu-ray Drive" (📖 p. 84)

Playing Back with an External Blu-ray Drive

You can play back the Blu-ray discs created on this unit.

- 1 Prepare an external Blu-ray drive.

- Insert the Blu-ray disc to play back into the external Blu-ray drive. "Preparing an External Blu-ray Drive" (📖 p. 81)

- 2 Tap "PLAYBACK" in the BACK-UP menu.

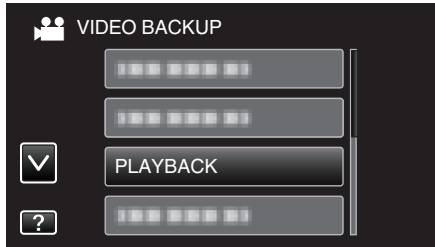

- An index screen (thumbnail display) of the videos in the disc appears.
- Tap “←” to return to the “BACK-UP” menu.
- Images recorded in 3D mode and 2D mode are displayed on the index screen separately. Press the 3D button to switch to the desired mode for playback.
- During 3D mode, “3D” is displayed on the LCD monitor.
- During 2D mode, “2D” is displayed on the LCD monitor.

3 Tap on the file to start playback.



- For details on video playback, refer to ““Operation Buttons for Video Playback” (p. 54) ”.
- “Operation Buttons for Video Playback” (p. 54)
- To exit, stop playback and turn off the camcorder by pressing the ⏻ button for about 2 seconds. Then, disconnect the USB cable.

Memo :

- Images recorded in 2D mode cannot be displayed as 3D images.
 - 3D images may be played back when the 3D button lights up.
 - 3D images recorded in “MP4(MVC)” format and “AVCHD” format are displayed on the index screen separately.
Change the setting of 3D VIDEO REC FORMAT to the desired format for playback.
- “3D VIDEO REC FORMAT (3D mode only)” (p. 107)
- It is recommended to play back in stop-motion for scenes that are likely to cause motion sickness during 3D playback.
 - By default, “3D MOTION RELIEF” is set to “ON”. Scenes that are likely to cause motion sickness during 3D playback may be played back in stop-motion, but this is not a malfunction. To play back normally, set “3D MOTION RELIEF” to “OFF”.
- “3D MOTION RELIEF (3D mode only)” (p. 120)
- Videos recorded in MP4(MVC) format can only be played back when dubbed to a Blu-ray disc.
 - Videos recorded in AVCHD format can be played back from either a Blu-ray disc or DVD.
 - When playing back a disc created in DVD-Video format, no information such as date and time will be displayed.

For customers who completed the firmware update :

- 3D images recorded in “MP4(MVC)” format, “AVCHD 3D” format and “AVCHD” format are displayed on the index screen separately.
Change the setting of 3D VIDEO REC FORMAT to the desired format for playback.
- “3D VIDEO REC FORMAT (3D mode only)” (p. 107)
- Videos recorded in AVCHD 3D format can only be played back when dubbed to a Blu-ray disc.

Creating a Disc Using a Connected Blu-ray Recorder

You can create discs using a Blu-ray recorder by connecting it to this unit using a USB cable.

- 1 Connect the USB cable and the AC adapter.
 - Turn off the camcorder by pressing the ⏻ button for about 2 seconds.

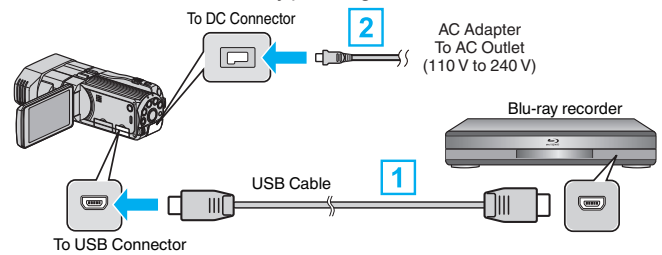

- 1 Connect using the provided USB cable.
- 2 Connect the AC adapter to this unit.
 - This unit powers on automatically when the AC adapter is connected.
 - Be sure to use the supplied JVC AC adapter.
 - The “SELECT DEVICE” screen appears.

2 Tap “CONNECT TO OTHER”.

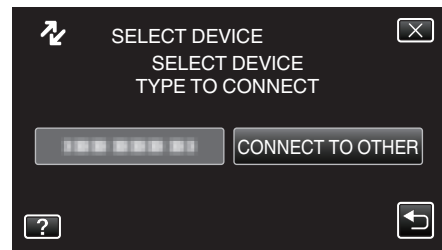

3 Tap the desired media.

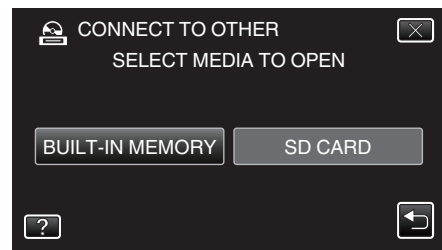

- 4 Perform dubbing on the Blu-ray recorder.
 - Refer also to the instruction manual of the Blu-ray recorder.

Caution :

- MP4(MVC) videos cannot be copied.

Memo :

- The created discs are playable only on AVCHD compatible devices (such as Blu-ray recorders).

For customers who completed the firmware update :

- Videos recorded in AVCHD 3D format cannot be saved to the Blu-ray recorder that are not compatible with AVCHD 3D.
- Videos recorded in AVCHD 3D format can only be played back on Blu-ray recorder etc., that is compatible with AVCHD 3D.

Dubbing Files by Connecting to a DVD Recorder

You can dub videos in standard quality by connecting to a DVD recorder.

- Refer also to the instruction manuals of the TV and DVD recorder.

- 1 Open the LCD monitor, then press and hold the power button for 2 seconds or more to turn off the power.

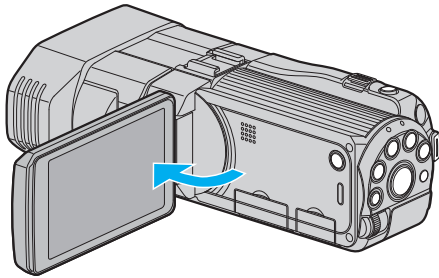

- 2 Connect to a DVD recorder.

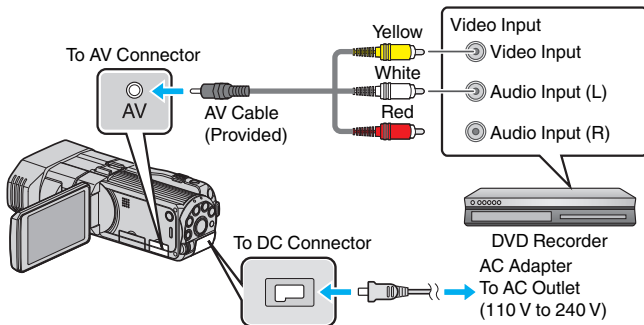

- 1 Connect using the provided AV cable.

- 2 Connect the AC adapter to this unit.

- This unit powers on automatically when the AC adapter is connected.

- 3 Tap to select the playback mode.

- 4 Prepare the TV/DVD recorder for recording.

- Switch to a compatible external input.
- Insert a disc (DVD-R, etc.) into the DVD recorder.

- 5 Prepare this unit for playback.

- Set "VIDEO OUTPUT" in the "COMMON" menu to the aspect ratio ("4:3" or "16:9") of the connecting TV.
- "VIDEO OUTPUT (2D mode only)" (p. 130)

- 6 Start recording.

- Start playback on this unit and press the record button on the recorder.

"Playing Back Videos" (p. 53)

- After playback is complete, stop the recording.

Caution :

- 3D videos cannot be dubbed.

Using a USB External Hard Disk Drive

You can copy video and still image files to a USB external hard disk drive from this unit. You can also play the files in the USB external hard disk drive on this unit.

- Refer also to the instruction manual of the external hard disk drive.

Compatible External Hard Disk Drives

You can use the "LaCie Hard Disk Sleek black design USB2.0" series from LaCie.

Memo :

Before purchasing, check the compatible devices on the LaCie website.

- LaCie

<http://www.lacie.com/home.htm?cc=1>

- USB external hard disk drives up to 2 TB can be used.

Copying and Playback with a USB External Hard Disk Drive

"Preparing a USB External Hard Disk Drive" (p. 87)

"Copying All Files" (p. 87)

"Playing Back Files in the USB External Hard Disk Drive" (p. 88)

"Deleting Folders in the USB External Hard Disk Drive" (p. 89)

Importing Files from the USB External Hard Disk Drive

"Importing Files from the USB External Hard Disk Drive" (p. 90)

Memo :

- Format the USB external hard disk drive when connecting it to this unit for the first time. (All data will be deleted.)

"Formatting the USB External Hard Disk Drive" (p. 90)

- Refer to the help file of the provided Everio MediaBrowser 3D software when you use the PC to operate the data in the USB external hard disk drive directly copied from this unit.

- USB external hard disk drives with the capacity over 2 TB cannot be used.
- Copying may take time. (For example, saving 1 hour video in XP mode takes about 20 minutes.)
- When there are many files to back up, it may take time for the backup to be completed. Wait for a while as the access lamp appears blinking, which indicates normal operation.
- Sound or video may be interrupted during playback.

Caution :

- Do not connect a USB hub between this unit and the USB external hard disk drive.
- Disconnect the USB external hard disk drive when using other USB devices such as DVD writer, external Blu-ray drive, or another USB external hard disk drive.
- Avoid the following operations during copying and playing back.
 - Turning off the unit or the USB external hard disk drive.
 - Disconnecting the USB cable.
- Do not format the USB external hard disk drive using the PC. If you did, format again using this unit. (All the data in the USB external hard disk drive will be erased.)
- Avoid the following operations using the PC.
 - Deleting files or folders in the USB external hard disk drive.
 - Moving files or folders in the USB external hard disk drive.
 - Changing the name of files or folders in the USB external hard disk drive. These operations make the data impossible to be played back on this unit.
- When you use the PC to edit the data in the USB external hard disk drive, copy the data to the PC before editing. Editing the data in the USB external hard disk drive directly from the PC makes the data impossible to be played back on this unit.

Preparing a USB External Hard Disk Drive

Memo :

- When connecting to the external hard disk drive, use a USB cable with Mini-A (Male) – B (Male) connectors. The USB cable provided with this unit cannot be used.
- To use the USB cable provided with the external hard disk drive, purchase the following USB extension cable.
Mini-A (Male) – A (Female)
(Part number: QAM0852-001)

1 Connect the USB cable and the AC adapter.

- Turn off the camcorder by pressing the button for about 2 seconds.

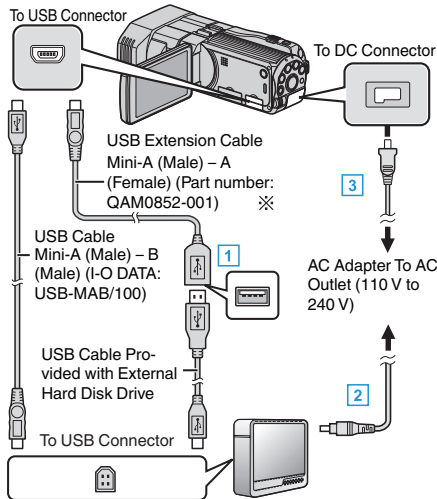

* Consult your nearest service center.

- 1 Connect the USB cable with the USB external hard disk drive.
- 2 Connect the AC adapter of the USB external hard disk drive.
- 3 Connect the AC adapter to this unit.

- This unit powers on automatically when the AC adapter is connected.
- This unit turns on and the “BACK-UP” menu appears.
- While the USB cable is connected, the “BACK-UP” menu is displayed.
- Refer also to the instruction manual of the external hard disk drive.

2 Turn on the external hard disk drive.

Caution :

- Be sure to turn off the power when connecting the devices. Otherwise, electric shocks or malfunctions may occur.
- Do not connect a USB hub between this unit and the USB external hard disk drive.

Copying All Files

All videos or still images recorded on this unit will be copied. You can also select and copy only the videos or still images that have never been copied.

1 Select 3D or 2D mode.

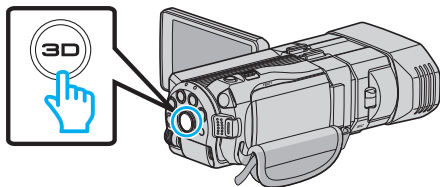

2 Select video or still image mode.

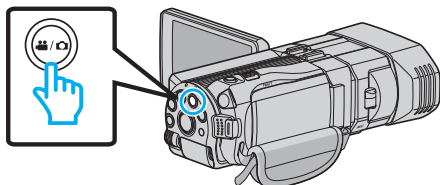

3 Tap “BACK UP”.

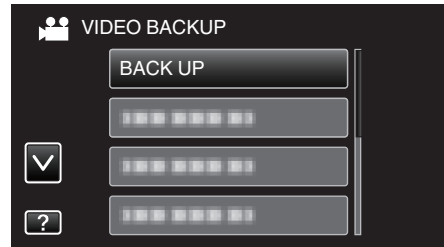

4 Tap on the media to copy.

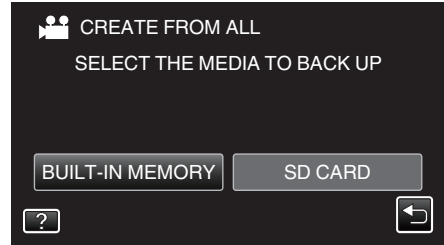

5 Tap the desired method.

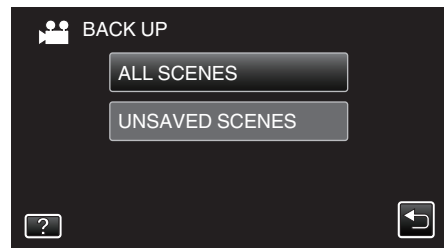

- “ALL SCENES” (video)/“ALL IMAGES” (still image):

All videos or still images in this unit are copied.

- “UNSAVED SCENES” (video)/“UNSAVED IMAGES” (still image):

Videos or still images that have never been copied are automatically selected and copied.

6 Check that there is sufficient remaining space on the hard disk drive and tap “YES”.

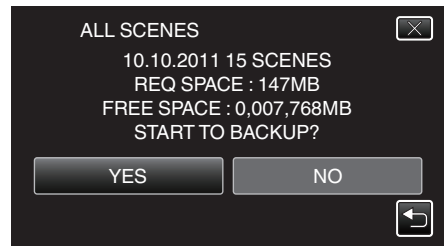

- Backup starts when “YES” is tapped.

7 After copying, tap “OK”.

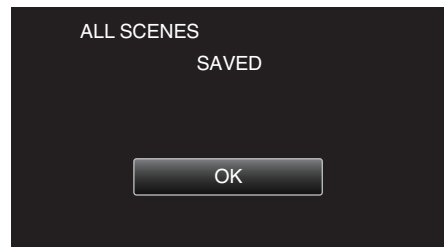

8 Press and hold the button for 2 seconds or more to turn off this unit and disconnect the USB cable.

Caution :

- Do not turn off the power or remove the USB cable until copying is complete.
- Files that are not on the index screen during playback cannot be copied.
- Copying may take time. (For example, saving 1 hour video in XP mode takes about 20 minutes.)

Playing Back Files in the USB External Hard Disk Drive

Videos or still images saved in an external hard disk drive can be played back on this unit.

- 1 Select 3D or 2D mode.

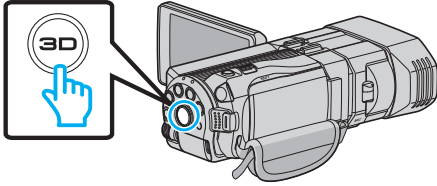

- 2 Select video or still image mode.

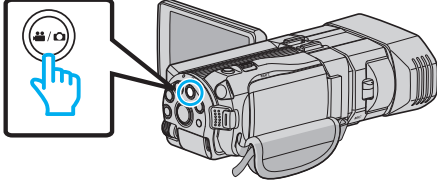

- 3 Tap "PLAYBACK".

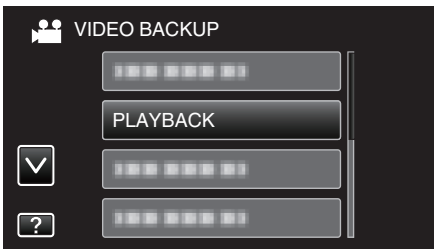

- 4 Tap on the folder to play back.

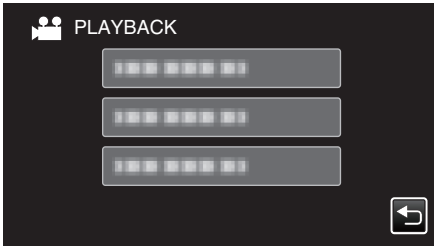

- Tap "⏪" to return to the "BACK-UP" menu.

- 5 Tap on the file to play back.



- Tap "⏪" to return to the folder index screen.
- For details on video playback, refer to "Operation Buttons for Video Playback" (p. 54).

"Operation Buttons for Video Playback" (p. 54)

- To exit, stop playback and turn off the camcorder by pressing the power button for about 2 seconds. Then, disconnect the USB cable.

Memo :

- Sound or video may be interrupted during playback.
- Images recorded in 3D mode and 2D mode are displayed on the index screen separately. Press the 3D button to switch to the desired mode for playback.
- 3D images recorded in "MP4(MVC)" format and "AVCHD" format are displayed on the index screen separately. Change the setting of 3D VIDEO REC FORMAT to the desired format for playback.

"3D VIDEO REC FORMAT (3D mode only)" (p. 107)

- To play back 3D images, refer also to "Precautions on Recording and Playing Back 3D Images".

"Precautions on Recording and Playing Back 3D Images" (p. 11)

For customers who completed the firmware update:

- 3D images recorded in "MP4(MVC)" format, "AVCHD 3D" format and "AVCHD" format are displayed on the index screen separately. Change the setting of 3D VIDEO REC FORMAT to the desired format for playback.

"3D VIDEO REC FORMAT (3D mode only)" (p. 107)

Caution :

Deleting Folders in the USB External Hard Disk Drive

Files that are copied to the external hard disk drive can be deleted.

Caution :

- Deleted files cannot be restored.
 - Be sure to back up important files on a PC.
- “Backing Up All Files” (p. 96)

Change the setting of 3D VIDEO REC FORMAT to the desired format for playback.

“3D VIDEO REC FORMAT (3D mode only)” (p. 107)

1 Select 3D or 2D mode.

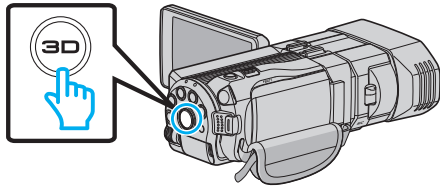

2 Select video or still image mode.

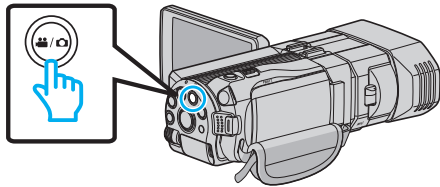

3 Tap “DELETE”.

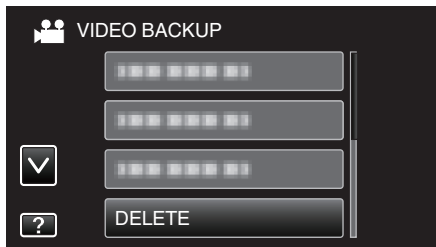

4 Tap on the folder to delete.

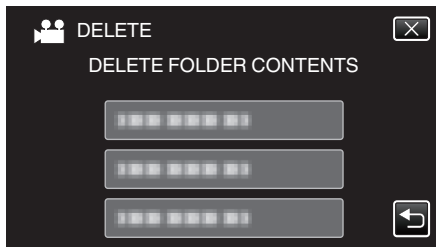

5 Tap “YES”.

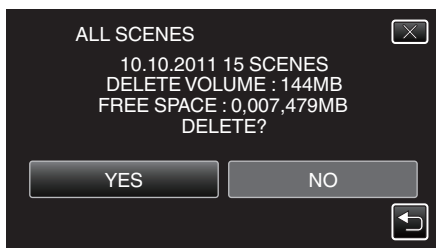

- After deleting, tap “OK”.

Memo :

- Images recorded in 3D mode and 2D mode are displayed on the index screen separately. Press the 3D button to switch to the desired mode for deletion.
- 3D images recorded in “MP4(MVC)” format and “AVCHD” format are displayed on the index screen separately. Change the setting of 3D VIDEO REC FORMAT to the desired format for deletion.

“3D VIDEO REC FORMAT (3D mode only)” (p. 107)

For customers who completed the firmware update :

- 3D images recorded in “MP4(MVC)” format, “AVCHD 3D” format and “AVCHD” format are displayed on the index screen separately.

Formatting the USB External Hard Disk Drive

All files on the external hard disk drive can be deleted.

Caution :

- All data on the external hard disk drive will be deleted when it is formatted. Copy all files on the card to a PC before formatting.

1 Select video or still image mode.

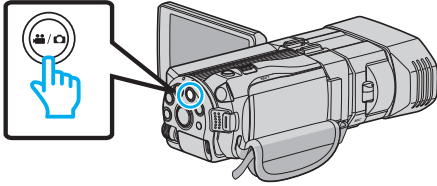

2 Tap "FORMAT".

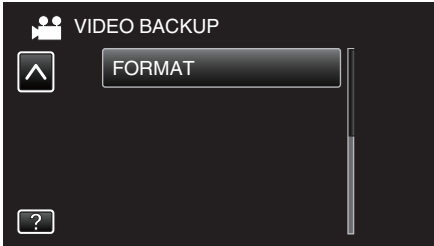

3 Tap "YES".

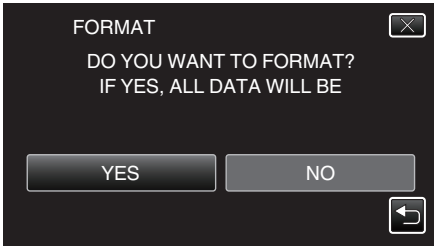

- After formatting, tap "OK".

Importing Files from the USB External Hard Disk Drive

You can copy video and still image files from a USB external hard disk drive to the built-in memory of this unit or an SD card.

1 Select 3D or 2D mode.

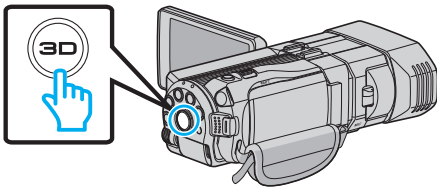

2 Select video or still image mode.

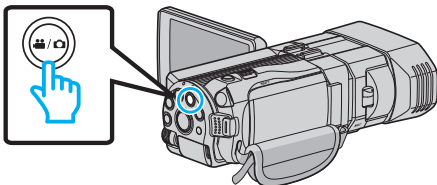

3 Tap "IMPORT FROM DEVICE" in "BACK-UP".

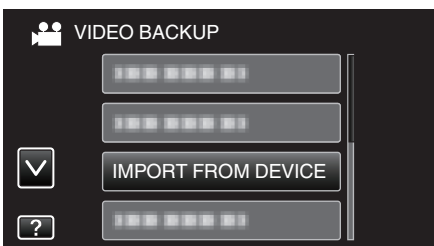

4 Tap "USB HDD→BUILT-IN MEM" or "USB HDD→SD".



- Files will be imported to the selected media.

5 Tap on the folder to import.



6 Tap on the files to import.



- ✓ appears on the selected files. To remove ✓ from a file, tap on the file again.
- Tap "SEL ALL" to select all files.
- Tap "REL ALL" to release all selections.
- "SET" is deactivated when no file is selected.

7 Tap "SET".

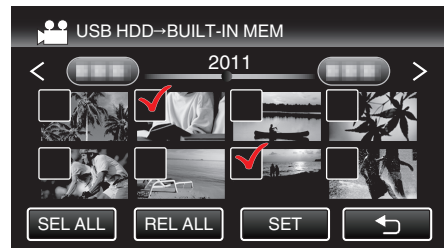

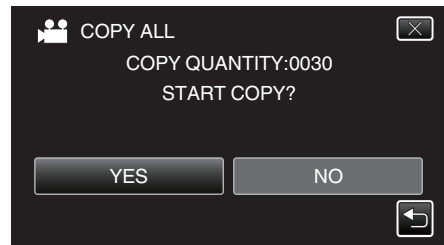

8 Tap "YES".

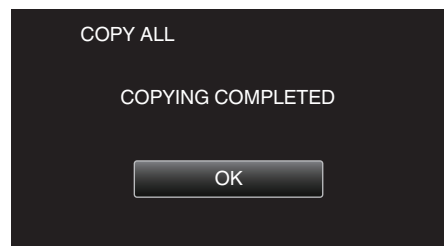

- Importing starts when "YES" is tapped.
- To cancel importing of files, tap "STOP", then tap "YES".

9 After importing, tap "OK".



10 Press and hold the  button for 2 seconds or more to turn off this unit and disconnect the USB cable.

Memo :

- Images recorded in 3D mode and 2D mode are displayed on the index screen separately. Press the 3D button to switch to the desired mode for importing.
- 3D images recorded in “MP4(MVC)” format and “AVCHD” format are displayed on the index screen separately. Change the setting of 3D VIDEO REC FORMAT to the desired format for importing.

“3D VIDEO REC FORMAT (3D mode only)” (☞ p. 107)

For customers who completed the firmware update :

- 3D images recorded in “MP4(MVC)” format, “AVCHD 3D” format and “AVCHD” format are displayed on the index screen separately. Change the setting of 3D VIDEO REC FORMAT to the desired format for playback.

“3D VIDEO REC FORMAT (3D mode only)” (☞ p. 107)

Dubbing Files to a VHS Tape Using a VCR

You can dub videos in standard quality by connecting to a VCR.

- Refer also to the instruction manuals of the TV and VCR.

Caution :

- 3D images cannot be copied to a VHS tape. Images recorded in 3D mode cannot be copied as 2D images.

- 1 Open the LCD monitor, then press and hold the power button for 2 seconds or more to turn off the power.

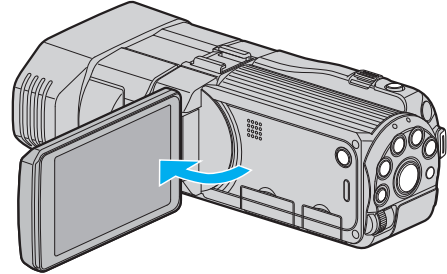

- 2 Connect to a VCR/DVD recorder.

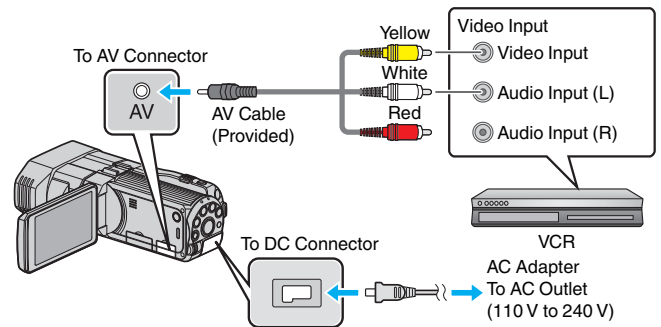

- 1 Connect using the provided AV cable.
- 2 Connect the AC adapter to this unit.

- This unit powers on automatically when the AC adapter is connected.

- 3 Tap  to select the playback mode.

- 4 Prepare the TV/VCR for recording.

- Switch to a compatible external input.
- Insert a video tape.

- 5 Prepare this unit for playback.

- Set “VIDEO OUTPUT” in the “COMMON” menu to the aspect ratio (“4:3” or “16:9”) of the connecting TV.

“VIDEO OUTPUT (2D mode only)” (☞ p. 130)

- 6 Start recording.

- Start playback on this unit and press the record button on the recorder.

“Playing Back Videos” (☞ p. 53)

- After playback is complete, stop the recording.

Copying Files to an SD Card

You can copy videos and still images from the built-in memory to SD card. Copying still images to cards makes it convenient to bring them to the shop for printing (developing).

Caution :

- Make sure that there is enough space left in the destination medium.
- Videos and still images in the SD card cannot be copied to the built-in memory.

1 Select 3D or 2D mode.

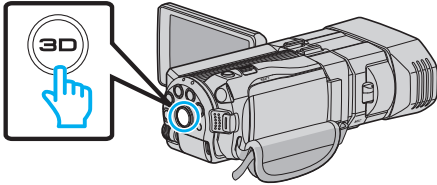

2 Select video or still image mode.

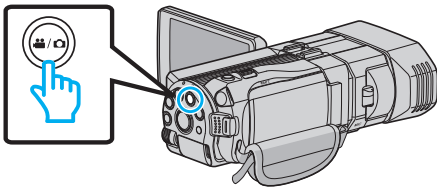

3 Tap to select the playback mode.

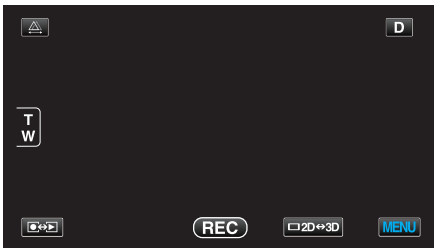

4 Tap "MENU".



5 Tap "COPY".

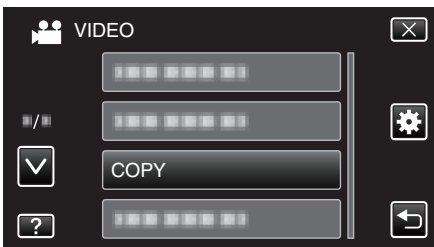

6 Tap on the files to copy.



- ✓ appears on the selected files.
To remove ✓ from a file, tap on the file again.

- Tap "SEL ALL" to select all files.
- Tap "REL ALL" to release all selections.
- "SET" is deactivated when no file is selected.

7 Tap "SET".



8 Tap "YES".

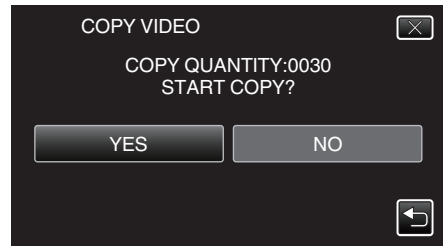

- Copying starts.
- After copying, tap "OK".

Moving Files to an SD Card

You can move videos and still images from the built-in memory to SD card. Files that are moved will be deleted from the built-in memory. Moving still images to SD cards makes it convenient to bring them to the shop for printing (developing).

Caution :

- Make sure that there is enough space left in the destination medium.
- Videos and still images in the SD card cannot be moved to the built-in memory.

1 Select 3D or 2D mode.

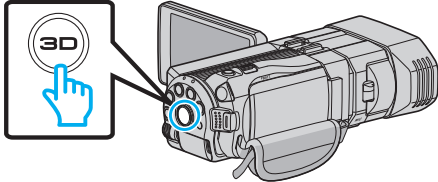

2 Select video or still image mode.

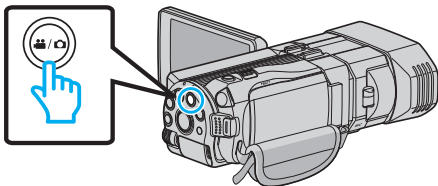

3 Tap to select the playback mode.

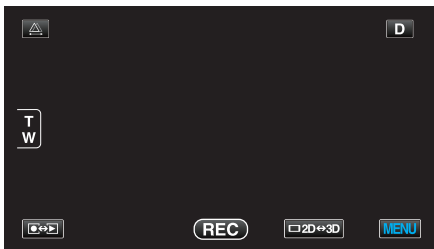

4 Tap "MENU".



5 Tap "MOVE".

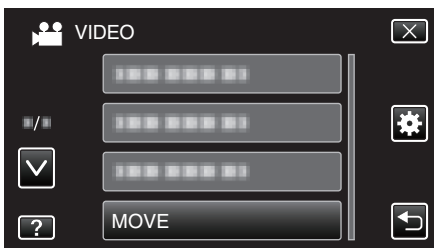

6 Tap on the files to move.



- ✓ appears on the selected files.

To remove ✓ from a file, tap on the file again.

- Tap "SEL ALL" to select all files.
- Tap "REL ALL" to release all selections.
- "SET" is deactivated when no file is selected.

7 Tap "SET".



8 Tap "YES".



- Moving of files starts.
- After moving, tap "OK".

Copying to Windows PC

You can copy files to a computer using the provided software.

DVDs can also be created using the computer's DVD drive.

If the provided software is not installed, this unit will be recognized as an external storage when connected.

Memo :

- To record to discs, a recordable DVD or Blu-ray drive is required for the computer in use.
- Still images cannot be recorded to discs using the provided software.

Trouble with Using the Provided Software Everio MediaBrowser 3D

Consult the customer service center below.

- Pixela User Support Center

Telephone	USA and Canada (English): +1-800-458-4029 (toll-free) Europe (UK, Germany, France, and Spain) (English/German/French/Spanish): +800-1532-4865 (toll-free) Other Countries in Europe (English/German/French/Spanish): +44-1489-564-764 Asia (Philippines) (English): +63-2-438-0090 China (Chinese): 10800-163-0014 (toll-free)
Homepage	http://www.pixela.co.jp/oem/jvc/mediabrowser/e/

- For details on how to upload to YouTube, refer to Everio MediaBrowser 3DHelp in the "Help" menu of Everio MediaBrowser 3D.

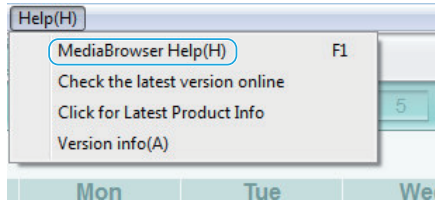

Verifying System Requirements (Guideline)

Right-click on “Computer” (or “My Computer”) in the “Start” menu and select “Properties” to check the following items.

Windows Vista/Windows 7

- Refer to the operating instructions found in the animation on the Detailed User Guide.

Windows XP

- Refer to the operating instructions found in the animation on the Detailed User Guide.

	Windows Vista/Windows 7	Windows XP
OS	Windows Vista 32/64-bit Home Basic or Home Premium (Pre-installed versions only) Service Pack 2 Windows 7 32/64-bit Home Premium (Pre-installed versions only)	Windows XP Home Edition or Professional (Pre-installed versions only) Service Pack 3
CPU	Intel Core Duo CPU 1.66 GHz or higher (Intel Core 2 Duo CPU 2.13 GHz or higher recommended) (Video editing/AVCHD(3D) playback: Intel Core i7 CPU 2.53 GHz or higher recommended)	Intel Core Duo CPU 1.66 GHz or higher (Intel Core 2 Duo CPU 2.13 GHz or higher recommended) (Video editing/AVCHD(3D) playback: Intel Core i7 CPU 2.53 GHz or higher recommended)
RAM	At least 2 GB	At least 1 GB

Other requirements

- Display: 1024×768 pixels or above (1280×1024 pixels or above recommended)
- Graphic: Intel G965 or higher recommended

Memo :

- If your PC does not meet the above system requirements, operations of the provided software cannot be guaranteed.
- For more information, contact your PC's manufacturer.

Installing the Provided Software

You can display the recorded images in calendar format and perform simple editing using the provided software.

- Refer to the operating instructions found in the animation on the Detailed User Guide.

Copying

Backing Up All Files

Before making backup, make sure that enough free space is left in the computer's hard disk (HDD).

1 Connect the USB cable and the AC adapter.

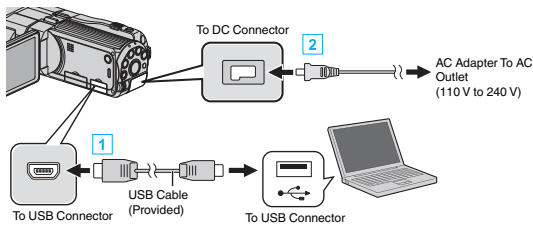

1 Connect using the provided USB cable.

2 Connect the AC adapter to this unit.

- This unit powers on automatically when the AC adapter is connected.
- Be sure to use the supplied JVC AC adapter.
- The "SELECT DEVICE" menu appears.

2 Tap "CONNECT TO PC".



3 Tap "BACK UP".

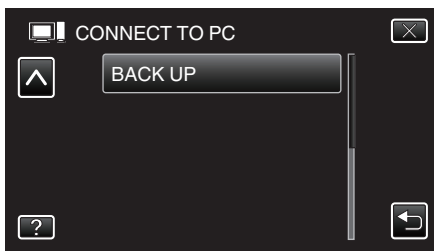

- Tap X to exit the menu.
- Tap ↶ to return to the previous screen.
- The provided software Everio MediaBrowser 3D starts up on the computer.
The subsequent operations are to be performed on the computer.

4 Select "Back-up".

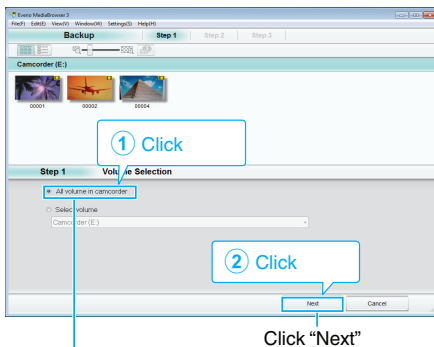

Click "All volume in camcorder"

5 Start backup.

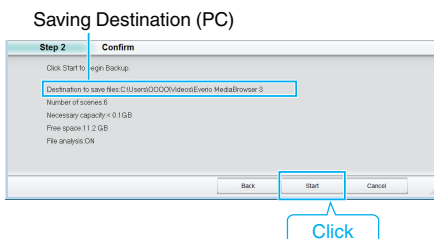

- Backup starts.

6 After backup is complete, click "OK".

Memo :

- Before making backup, load the SD card in which the videos and still images are stored on this unit.
- If you encounter any problems with the provided software Everio MediaBrowser 3D, please consult the "Pixela User Support Center".

Telephone	USA and Canada (English): +1-800-458-4029 (toll-free) Europe (UK, Germany, France, and Spain) (English/German/French/Spanish): +800-1532-4865 (toll-free) Other Countries in Europe (English/German/French/Spanish): +44-1489-564-764 Asia (Philippines) (English): +63-2-438-0090 China (Chinese): 10800-163-0014 (toll-free)
Homepage	http://www.pixela.co.jp/oem/jvc/mediabrowser/e/

- Delete unwanted videos before making backup.
It takes time to back up many videos.

"Deleting Unwanted Files" (p. 67)

Disconnecting this Unit from Computer

1 Click "Safely Remove Hardware and Eject Media".

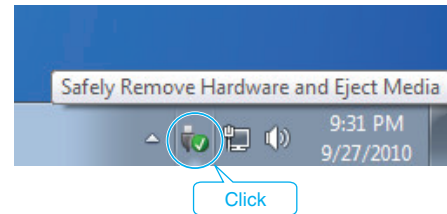

2 Click "Safely Remove USB Mass Storage Device".

3 (For Windows Vista) Click "OK".

4 Disconnect the USB cable and close the LCD monitor.

Organizing Files

After backing up your files, organize them by adding labels such as “Family Trip” or “Athletic Meet”. This is useful not only for creating discs, but for viewing the files too.

- 1 Double-click on the Everio MediaBrowser 3D icon.
 - The provided software starts up.



- 2 Display the month of the files to organize.

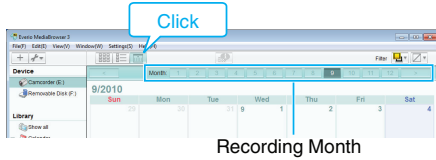

- 3 Create a user list.

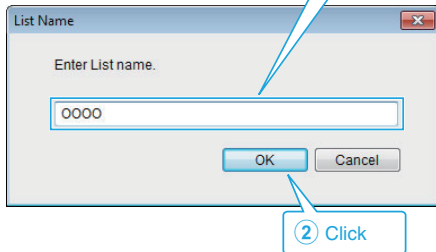
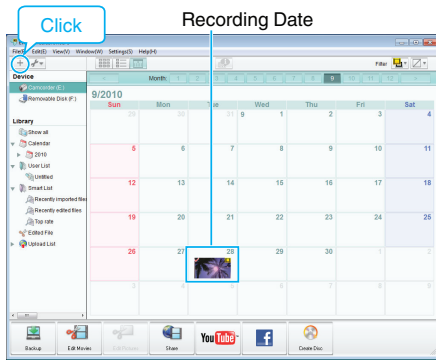

- A new user list is added to the user list library.
- 4 Click on the recording day.
 - The thumbnails of the files recorded on the day are displayed.
 - 5 Register files to the created user list.

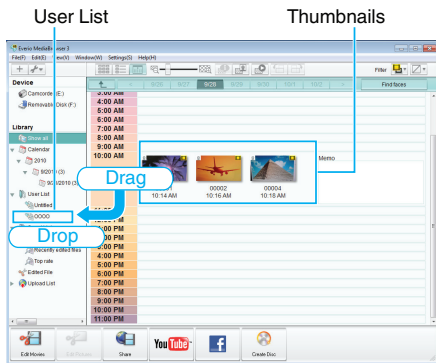

Identifying Video or Still Image :

- You can select files using the "SELECT" menu on the top right of the screen.
- Check the video/still image icon on the top right corner of the thumbnail.

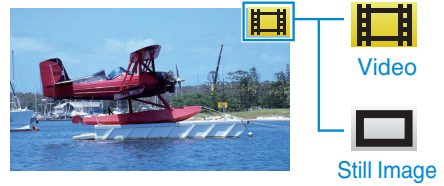

Memo :

- If you encounter any problems with the provided software Everio MediaBrowser 3D, please consult the “Pixela User Support Center”.

Telephone	USA and Canada (English): +1-800-458-4029 (toll-free) Europe (UK, Germany, France, and Spain) (English/German/French/Spanish): +800-1532-4865 (toll-free) Other Countries in Europe (English/German/French/Spanish): +44-1489-564-764 Asia (Philippines) (English): +63-2-438-0090 China (Chinese): 10800-163-0014 (toll-free)
Homepage	http://www.pixela.co.jp/oem/jvc/mediabrowser/e/

Recording Videos to Discs

Copy the files that are arranged using the user list to discs.

- 1 Insert a new disc into the PC's recordable DVD or Blu-ray drive.
- 2 Select the desired user list.

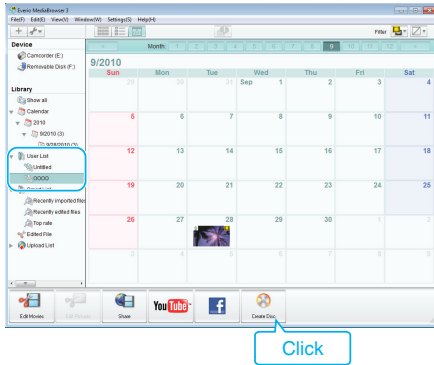

- 3 Select the files to copy to disc in order.

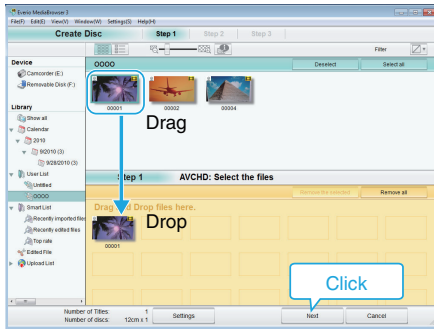

- Click "Settings" to select the disc type. Image quality is set to standard when DVD-Video is selected.
- Click "Select all" to select all the displayed files.
- After selecting, click "Next".

- 4 Set the title of the top menu of the disc.

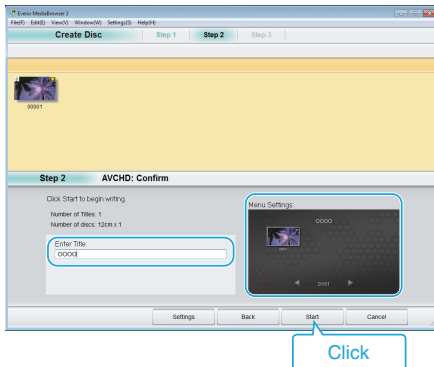

- Click "Settings" to select the menu background.
- After setting, click "Start".

- 5 After copying is complete, click "OK".

Caution :

- When creating a disc with 3D images, there may be certain limitations due to the recording format. For details, refer to the help file of the provided Everio MediaBrowser 3D software.
- To view the help file of Everio MediaBrowser 3D, select "Help" from the Everio MediaBrowser 3D's menu bar or press F1 on the keyboard.

Memo :

- The following types of discs can be used on the provided software Everio MediaBrowser 3D.
 - DVD-R
 - DVD-R DL
 - DVD-RW
 - DVD+R
 - DVD+R DL
 - DVD+RW
 - BD-R
 - BD-RE
 - The following formats are supported by the provided software Everio MediaBrowser 3D.
 - DVD-Video
 - AVCHD
 - BD
 - When copying videos recorded in UXP recording mode to create an AVCHD disc, the videos need to be converted to XP recording mode before copying. Therefore, it may take a longer time than copying videos recorded in other modes.
 - Use Everio MediaBrowser 3D Player to play back an AVCHD disc. Refer to the help file of the provided Everio MediaBrowser 3D software to operate.
 - To view the help file of Everio MediaBrowser 3D, select "Help" from the Everio MediaBrowser 3D's menu bar or press F1 on the keyboard.
 - If you encounter any problems with the provided software Everio MediaBrowser 3D, please consult the "Pixela User Support Center".
- For customers who completed the firmware update :
- Use Everio MediaBrowser 3D Player to play back an AVCHD 3D disc. Refer to the help file of the provided Everio MediaBrowser 3D software to operate.

Telephone	USA and Canada (English): +1-800-458-4029 (toll-free) Europe (UK, Germany, France, and Spain) (English/German/French/Spanish): +800-1532-4865 (toll-free) Other Countries in Europe (English/German/French/Spanish): +44-1489-564-764 Asia (Philippines) (English): +63-2-438-0090 China (Chinese): 10800-163-0014 (toll-free)
Homepage	http://www.pixela.co.jp/oem/jvc/mediabrowser/e/

Backing Up Files Without Using Provided Software

Copy the files to a computer using the following method.

1 Connect the USB cable and the AC adapter.

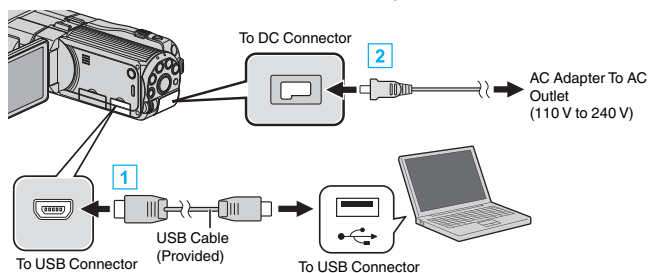

- 1 Connect using the provided USB cable.
- 2 Connect the AC adapter to this unit.
 - This unit powers on automatically when the AC adapter is connected.
 - Be sure to use the supplied JVC AC adapter.
 - The “SELECT DEVICE” menu appears.

2 Tap “CONNECT TO PC”.



3 Tap “PLAYBACK ON PC”.

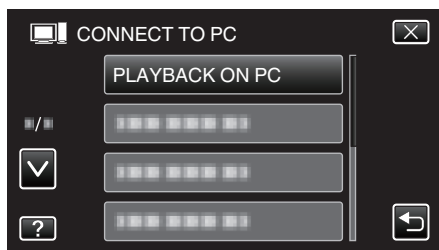

- Tap X to exit the menu.
- Tap ↶ to return to the previous screen.
- Close the Everio MediaBrowser 3D program, if it starts.
- The subsequent operations are to be performed on the computer.

4 Select “Computer” (Windows Vista) / “My Computer” (Windows XP) / “Computer” (Windows 7) from the “Start” menu, then click on the “JVCCAM_MEM” or “JVCCAM_SD” icon.

- Open the folder with the desired files.
“List of Files and Folders” (p. 100)

5 Copy the files to any folder in the computer (desktop, etc).

Caution :

- When the folders or files are deleted/moved/renamed in the computer, they cannot be played back on this unit anymore.

Memo :

- To edit/view the files, use a software that supports AVCHD (video)/MP4 (video)/MPF (3D still image)/JPEG (2D still image) files.
- The above operations on computer may vary with the system used.

For customers who completed the firmware update :

- To edit or view the AVCHD 3D files, use a software that supports AVCHD 3D (video).

Disconnecting this Unit from Computer

1 Click “Safely Remove Hardware and Eject Media”.

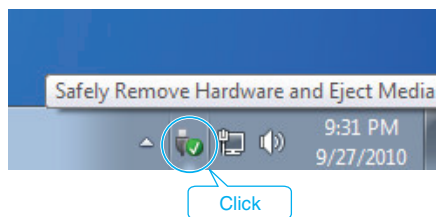

2 Click “Safely Remove USB Mass Storage Device”.

3 (For Windows Vista) Click “OK”.

4 Disconnect the USB cable and close the LCD monitor.

Copying

List of Files and Folders

Folders and files are created in the built-in memory and SD card as shown below. They are created only when necessary.

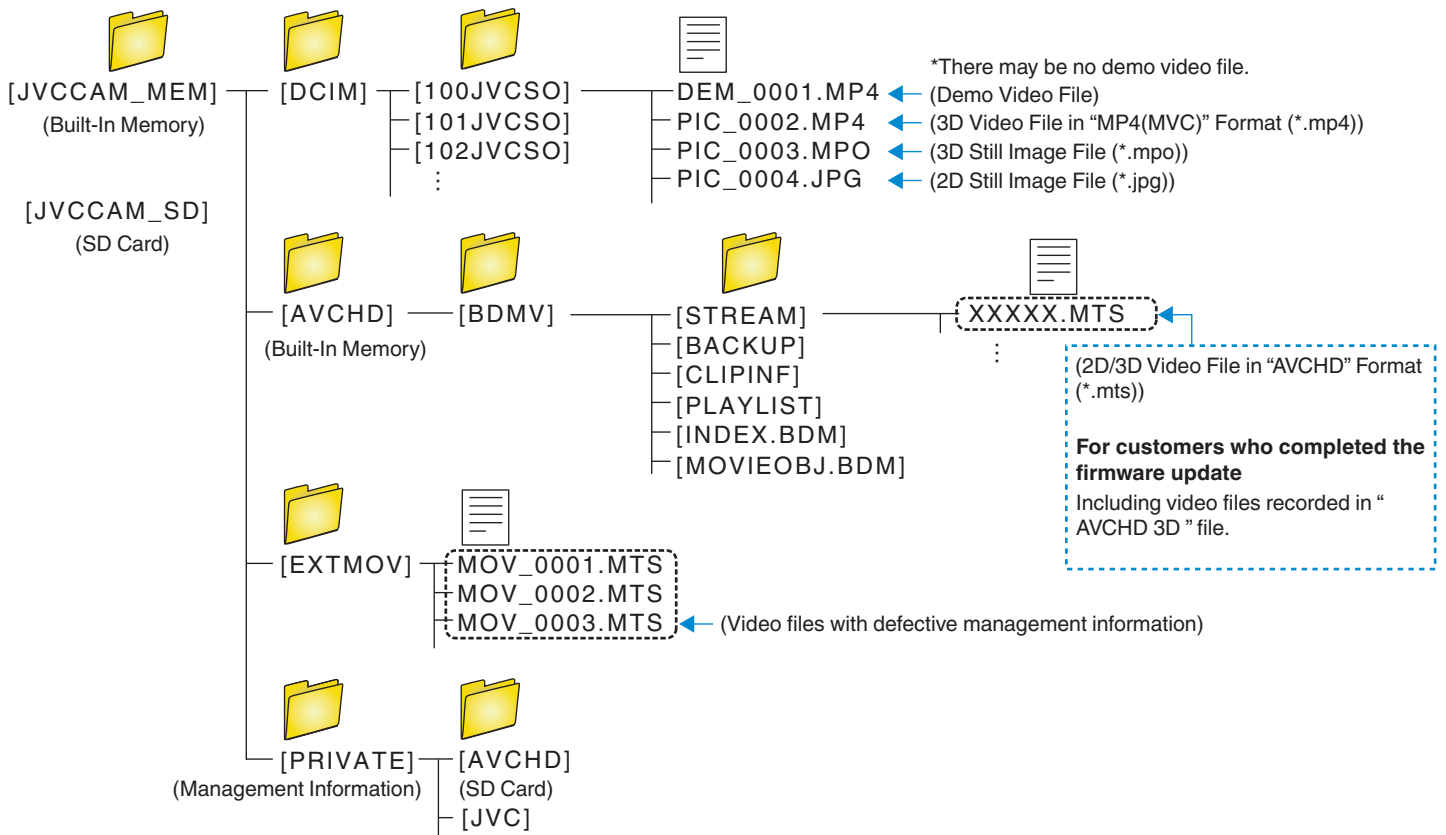

Caution :

- When the folders or files are deleted/moved/renamed in the computer, they cannot be played back on this unit anymore.

JVC Software Licence Agreement

IMPORTANT

TO CUSTOMERS: PLEASE MAKE SURE TO READ THIS CAREFULLY BEFORE INSTALLING OR USING THE SOFTWARE PROGRAM NAMED "DIGITAL PHOTO NAVIGATOR" ("Program") ON YOUR PC.

The right to use the Program is granted by Victor Company of Japan, Limited ("JVC") to You only on the condition that You agree to the following.

Should You not agree to the terms hereof, You may not install or use the Program. HOWEVER, INSTALLING OR USING THE PROGRAM INDICATES YOUR ACCEPTANCE OF THESE TERMS AND CONDITIONS.

1 COPYRIGHT; OWNERSHIP

You acknowledge that all copyrights and other intellectual property rights in the Program are owned by JVC and its licensor, and remain vested in JVC and such licensor. The Program is protected under the copyright law of Japan and other countries, and related Conventions.

2 GRANT OF LICENCE

- 1 Subject to the conditions of this Agreement, JVC grants to You a non-exclusive right to use the Program. You may install and use the Program on a HDD or other storage devices incorporated in Your PC.
- 2 You may make one (1) copy of the Program solely for your personal backup or archival purposes.

3 RESTRICTION ON THE PROGRAM

- 1 You may not reverse engineer, decompile, disassemble, revise or modify the Program, except to the extent that expressly permitted by applicable law.
- 2 You may not copy or use the Program, in whole or in part, other than as expressly specified in this Agreement.
- 3 You have no right to grant a licence to use the Program, and may not distribute, rent, lease or transfer the Program to any third party or otherwise let them use the Program.

4 LIMITED WARRANTY

JVC warrants that any media in which the Program is embodied are free from any defects in materials and workmanship for a period of thirty (30) days from the date of Your purchasing any our products accompanying the Program. JVC's entire liability and your exclusive remedy in connection with the Program shall be replacement of such defective media. EXCEPT FOR THE EXPRESS WARRANTIES STATED HEREIN AND TO THE EXTENT PERMITTED BY APPLICABLE LAW, JVC AND ITS LICENSORS DISCLAIM ANY OTHER WARRANTIES, EITHER EXPRESS OR IMPLIED, INCLUDING BUT NOT LIMITED TO IMPLIED WARRANTIES OF MERCHANTABILITY AND FITNESS FOR A PARTICULAR PURPOSE IN REGARD TO THE PROGRAM AND THE ACCOMPANYING PRINTED MATERIALS. SHOULD THERE BE ANY PROBLEM ARISING FROM OR CAUSED BY THE PROGRAM, YOU SHOULD SETTLE ALL SUCH PROBLEM AT YOUR OWN COST AND EXPENSE.

5 LIMITED LIABILITY

TO THE EXTENT PERMITTED BY APPLICABLE LAW, IN NO EVENT SHALL JVC AND ITS LICENSORS BE LIABLE FOR ANY INDIRECT, SPECIAL, INCIDENTAL OR CONSEQUENTIAL DAMAGES WHATSOEVER, REGARDLESS OF THE FORM OF ACTION WHETHER IN CONTRACT, TORT OR OTHERWISE ARISING OUT OF OR IN CONNECTION WITH THE USE OF OR INABILITY TO USE THE PROGRAM, EVEN IF JVC HAS BEEN ADVISED OF THE POSSIBILITY OF SUCH DAMAGES. YOU WILL INDEMNIFY AND HOLD HARMLESS JVC FROM ANY LOSS, LIABILITY OR COST ARISING OUT OF OR IN ANY WAY CONNECTED TO CLAIMS FROM ANY THIRD PARTY RELATING TO THE USE OF THE PROGRAM.

6 TERM

This Agreement will become effective on the date when You install and use the Program on Your machine, and continue to be in effect until the termination under the following provision.

Should You breach any provision of this Agreement, JVC may terminate this Agreement without giving any notice to You. In this event, JVC may claim against You for any damages caused by Your breach. Should this Agreement be terminated, You must immediately destroy the Program stored in Your machine (including the erasing from any memory in Your PC), and no longer own such Program.

7 EXPORT CONTROL

You agree that You will not ship, transfer or export the Program or underlying information and technology to any countries to which Japan and other relevant countries have initiated an embargo on such goods.

8 U.S. GOVERNMENT USER

If You are an agency of the United States of America (the "Government"), You acknowledge JVC's representation that the Program is a "Commercial Item" as defined in Federal Acquisition Regulation (FAR) part 2.101 (g) consisting unpublished "Commercial Computer Software" as those items are used at FAR part 12.212 and is only licenced to You with the same use rights JVC grants all commercial end users pursuant to the terms of this Agreement.

9 GENERAL

- 1 No modification, change, addition, deletion or other alternation of or to this Agreement will be valid unless reduced to writing and signed by an authorized representative of JVC.
- 2 If any part of this Agreement is held invalid by or in conflict with any law having jurisdiction over this Agreement, the remaining provisions will remain in full force and effect.
- 3 This Agreement shall be governed by and interpreted under the laws of Japan. The Tokyo District Court has jurisdiction over all disputes which may arise with respect to the execution, interpretation and performance of this Agreement.

Victor Company of Japan, Limited

Memo :

- If You acquired the Program in Germany, the provisions of Sections 4 (Limited Warranty) and 5 (Limited Liability) provided above will be replaced with those of the German version of this Agreement.

Caution :

- Operate this equipment according to the operating procedures described in this manual.
- Use only the provided CD-ROM. Never use any other CD-ROM to run this software.
- Do not attempt to modify this software.
- Changes or modifications not approved by JVC could void user's authority to operate the equipment.

How to handle a CD-ROM :

- Take care not to soil or scratch the mirror surface (opposite to the printed surface). Do not write anything or put a sticker on either the front or back surface. If the CD-ROM gets dirty, gently wipe it with a soft cloth outward from the center hole.
- Do not use conventional disc cleaners or cleaning spray.
- Do not bend the CD-ROM or touch its mirror surface.
- Do not store your CD-ROM in a dusty, hot or humid environment. Keep it away from direct sunlight.

Operating the Menu

There are two types of menus in this unit.

- Main menu:
Menu that contains all the items specific to the video recording, still image recording, video playback, and still image playback modes respectively.
-  menu in main (common) menu:
Menu that contains all common items in the video recording, still image recording, video playback, and still image playback modes.

Operating the Main Menu

You can configure various settings using the menu.

- 1 Tap "MENU".
 - The menu differs according to the mode in use.



- 2 Tap the desired menu.



- Tap \wedge or \vee to move upward or downward for more selection.

- 3 Tap the desired setting.

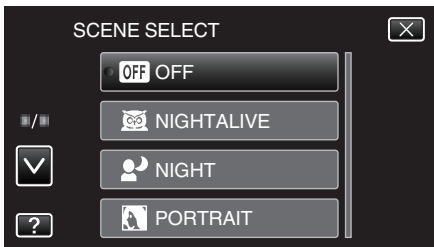

Memo :

- To exit the screen
Tap "X" (quit).
- To return to the previous screen
Tap " \curvearrowright " (return).
- To display the help file
Tap "?" (help) and tap the item.
- Help file may not be available for some items.

Operating the Common Menu

You can configure common setting items regardless of the mode using the common menu.

- 1 Tap "MENU".
 - The menu differs according to the mode in use.

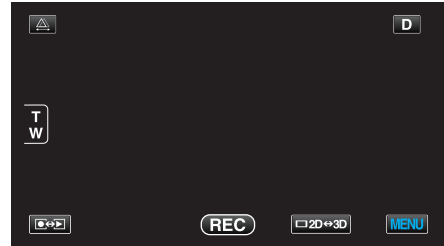

- 2 Tap .



- 3 Tap the desired setting.

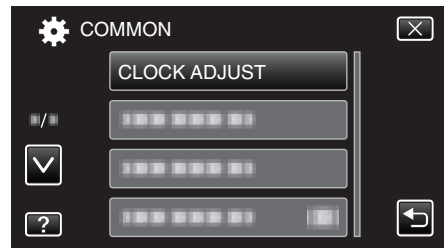

- Tap \wedge or \vee to move upward or downward for more selection.

Memo :

- To exit the screen
Tap "X" (quit).
- To return to the previous screen
Tap " \curvearrowright " (return).
- To display the help file
Tap "?" (help) and tap the item.
- Help file may not be available for some items.

Main Menu for Video Recording

You can adjust various settings, such as brightness and white balance, to suit the subject or purpose. You can also change settings such as picture quality and gain.

- 1 Select video mode.

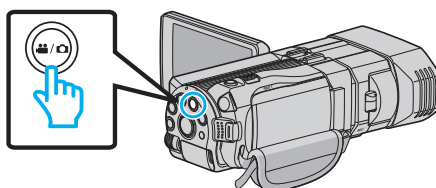

- 2 Tap  to select the recording mode.



- 3 Tap "MENU".

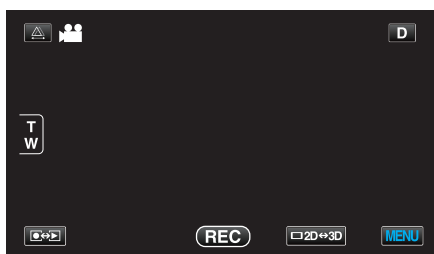

Setting	Details
SCENE SELECT	Settings to suit the shooting condition can be selected. "Scene Selection" (☞ p. 37) *Displayed only in the manual recording mode.
FOCUS	Focus can be adjusted manually. "Adjusting Focus Manually" (☞ p. 38) *Displayed only in the manual recording mode.
FOCUS ASSIST	Focused subject is outlined in color for more precise focus. "Using Focus Assist" (☞ p. 39) *Displayed only in the manual recording mode.
FOCUS ASSIST COLOR	Sets the color of the outline of a focused object when Focus Assist is used. "FOCUS ASSIST COLOR" (☞ p. 105) *Displayed only in the manual recording mode.
BRIGHTNESS ADJUST	Adjusts the overall brightness of the screen. "Adjusting Brightness" (☞ p. 39) *Displayed only in the manual recording mode.
SHUTTER SPEED	Shutter speed can be adjusted. "Setting Shutter Speed" (☞ p. 40) *Displayed only in the manual recording mode.
APERTURE PRIORITY	Adjusts the aperture value. "Setting Aperture" (☞ p. 40) *Displayed only in the manual recording mode.
WHITE BALANCE	Adjusts the color according to the light source. "Setting White Balance" (☞ p. 41) *Displayed only in the manual recording mode.

Menu Settings

Setting	Details
BACKLIGHT COMP.	Corrects the image when the subject appears dark due to backlight. “Setting Backlight Compensation” (☞ p. 42) *Displayed only in the manual recording mode.
TELE MACRO	Enables close-up shots when using the telephoto (T) end of the zoom. “Taking Close-up Shots” (☞ p. 42) *Displayed only in the 2D manual recording mode.
TOUCH PRIORITY AE/AF	Automatically adjusts focus and brightness based on the subjects' faces or selected area. “Capturing Subjects Clearly (TOUCH PRIORITY AE/AF)” (☞ p. 45)
DIS	Camera shake during recording can be effectively reduced. “Reducing Camera Shake” (☞ p. 45)
GAIN UP	Makes the subject appear bright automatically when recording in dark places. “GAIN UP” (☞ p. 106)
WIND CUT	Reduces the noise caused by wind. “WIND CUT” (☞ p. 106)
GRID	Displays gridlines to make it easier to detect when the subject appears slanted. “GRID” (☞ p. 107)
TIME-LAPSE RECORDING	Enables the changes of a scene that occur slowly over a long period to be shown within a short time by taking frames of it at a certain interval. “Recording at Intervals (TIME-LAPSE RECORDING)” (☞ p. 47)
3D VIDEO REC FORMAT	You can select a recording format for 3D video recording. “3D VIDEO REC FORMAT (3D mode only)” (☞ p. 107) *Displayed only in the 3D recording mode.
VIDEO QUALITY	Sets the video quality. “VIDEO QUALITY” (☞ p. 108)
ZOOM	Sets the maximum zoom ratio. “ZOOM (2D mode only)” (☞ p. 109) *Displayed only in the 2D recording mode.
x.v.Color	Captures the true colors. (Use an x.v.Color compatible TV for playback.) “x.v.Color (2D mode only)” (☞ p. 110) *Displayed only in the 2D recording mode.
USER BUTTON SETTING	Assigns a frequently used function to the USER button. “Setting the USER Button” (☞ p. 43)
3D SOUND	Records realistic audio sounds. You can enjoy more realistic audio sounds during playback of a video by recording it with “3D SOUND” set to “ON”. “3D SOUND” (☞ p. 110)
MIC LEVEL	Make the adjustments such that “MIC LEVEL” does not turn red. “MIC LEVEL” (☞ p. 111)
MIC LEVEL SETTING	Sets the microphone level. “MIC LEVEL SETTING” (☞ p. 111)
HEADPHONE VOL. ADJ.	Sets the volume level of the connected headphones. “HEADPHONE VOL. ADJ.” (☞ p. 112)

SCENE SELECT

Settings to suit the shooting condition can be selected.
 Operating Details
 "Scene Selection" (☞ p. 37)

FOCUS

Focus can be adjusted manually.
 Operating Details
 "Adjusting Focus Manually" (☞ p. 38)

FOCUS ASSIST

Focused subject is outlined in color for more precise focus.
 Operating Details
 "Using Focus Assist" (☞ p. 39)

FOCUS ASSIST COLOR

Sets the color of the outline of a focused object when Focus Assist is used.

Setting	Details
RED	Outlines the focused object in red.
GREEN	Outlines the focused object in green.
BLUE	Outlines the focused object in blue.

Displaying the Item

1 Select video mode.

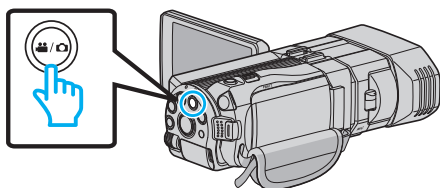

2 Tap [RECORD] to select the recording mode.



3 Tap "MENU".

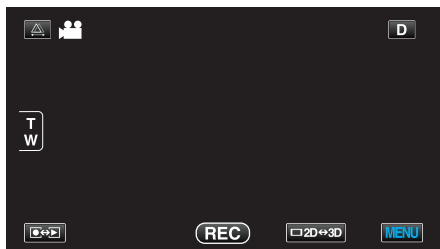

4 Tap "FOCUS ASSIST COLOR".

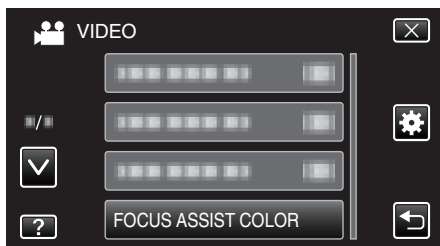

BRIGHTNESS ADJUST

Adjusts the overall brightness of the screen.
 Operating Details
 "Adjusting Brightness" (☞ p. 39)

SHUTTER SPEED

Shutter speed can be adjusted.
 Operating Details
 "Setting Shutter Speed" (☞ p. 40)

APERTURE PRIORITY

Adjusts the aperture value.
 Operating Details
 "Setting Aperture" (☞ p. 40)

WHITE BALANCE

Adjusts the color according to the light source.
 Operating Details
 "Setting White Balance" (☞ p. 41)

BACKLIGHT COMP.

Corrects the image when the subject appears dark due to backlight.
 Operating Details
 "Setting Backlight Compensation" (☞ p. 42)

TELE MACRO (2D mode only)

Enables close-up shots when using the telephoto (T) end of the zoom.
 Operating Details
 "Taking Close-up Shots" (☞ p. 42)

TOUCH PRIORITY AE/AF

Automatically adjusts focus and brightness based on the subjects' faces or selected area.
 Operating Details
 "Capturing Subjects Clearly (TOUCH PRIORITY AE/AF)" (☞ p. 45)

DIS

Camera shake during recording can be effectively reduced.
 Operating Details
 "Reducing Camera Shake" (☞ p. 45)

Menu Settings

GAIN UP

Makes the subject appear bright automatically when recording in dark places.

Setting	Details
OFF	Deactivates the function.
ON	Electrically brightens the scene when it is dark.
AUTO SLOW-SHUTTER	Automatically brightens the scene when it is dark.

Memo :

- Although AUTO SLOW-SHUTTER brightens the scene more than ON, movements of the subject may become unnatural.
- Setting can be adjusted separately for still images.

“GAIN UP (Still Image)” (p. 116)

Displaying the Item

- 1 Select video mode.

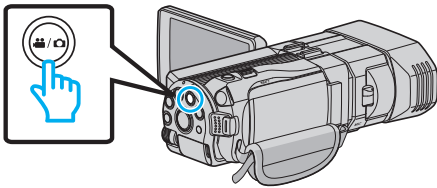

- 2 Tap to select the recording mode.



- 3 Tap “MENU”.

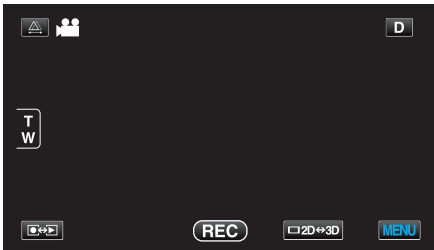

- 4 Tap “GAIN UP”.

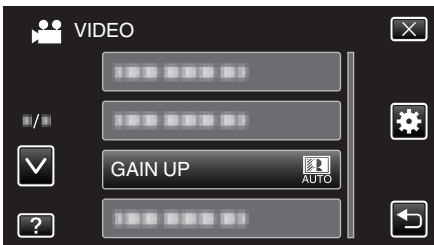

WIND CUT

Reduces the noise caused by wind.

Setting	Details
OFF	Deactivates the function.
ON	Activates the function.

Displaying the Item

- 1 Select video mode.

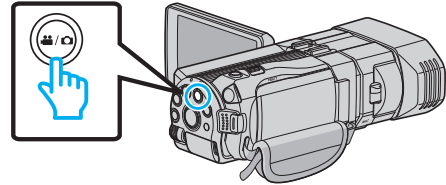

- 2 Tap to select the recording mode.



- 3 Tap “MENU”.

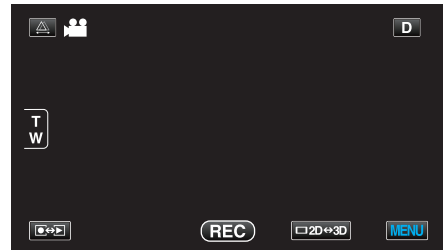

- 4 Tap “WIND CUT”.

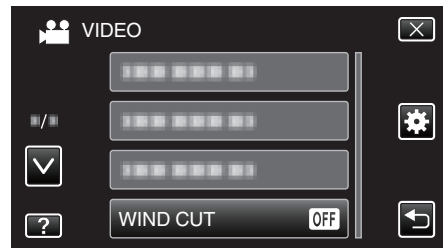

GRID

Displays gridlines to make it easier to detect when the subject appears slanted.

Setting	Details
OFF	Turns off grid display.
ON	Turns on grid display.

Displaying the Item

1 Select video mode.

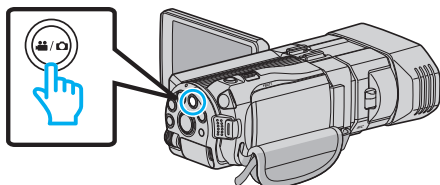

2 Tap to select the recording mode.



3 Tap "MENU".

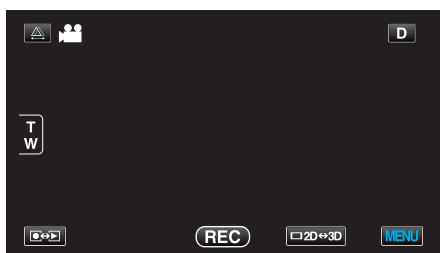

4 Tap "GRID".

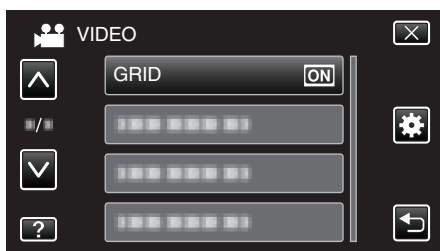

TIME-LAPSE RECORDING

Enables the changes of a scene that occur slowly over a long period to be shown within a short time by taking frames of it at a certain interval.

This is useful for making observations such as the opening of a flower bud.

Operating Details

"Recording at Intervals (TIME-LAPSE RECORDING)" (p. 47)

3D VIDEO REC FORMAT (3D mode only)

You can select a recording format for 3D video recording.

Setting	Details
AVCHD	Records in AVCHD format. Set to this recording format for higher compatibility.
MP4(MVC)	Records in MP4(MVC) format. Set to this recording format for higher video quality.

For customers who completed the firmware update

Setting for the 3D video recording format is as below:

Setting	Details
AVCHD 3D	Records in AVCHD 3D format. Set to to this in order to record in high picture quality while maintaining the compatibility. (Videos can be saved to a disc by using the AVCHD 3D compatible Blu-ray recorder. Please check "Copying Your Files" for details).
AVCHD	Records in AVCHD format. Set to this recording format for higher compatibility. (Videos can be saved to a disc by using the AVCHD or AVCHD 3D compatible Blu-ray recorder. Please check "Copying Your Files" for details).
MP4(MVC)	Records in MP4(MVC) format. Set to this recording format for higher definition picture quality.

Displaying the Item

1 Select video mode.

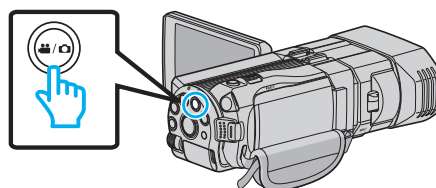

2 Tap to select the recording mode.



3 Tap "MENU".

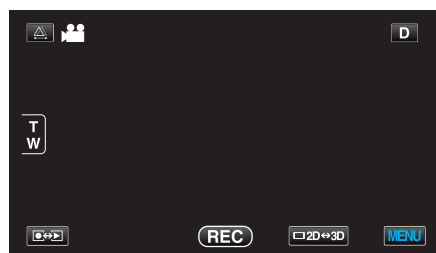

4 Tap "3D VIDEO REC FORMAT".

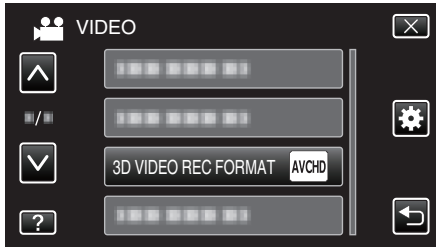

VIDEO QUALITY

Sets the video quality.

■ **3D Mode (MP4(MVC))**

Setting	Details
THR	Enables recording in high picture quality.
TSR	Enables long recordings.

■ **3D Mode (AVCHD)**

Setting	Details
TXP	Enables recording in high picture quality.
TSP	Enables long recordings.

■ **2D Mode**

Setting	Details
UXP	Enables recording in the best picture quality. <ul style="list-style-type: none"> • Applies to Blu-ray discs only. Videos taken in high-definition quality cannot be saved to DVDs.
XP	Enables recording in high picture quality.
SP	Enables recording in standard quality.
EP	Enables long recordings.

Memo :

- To avoid noise when recording fast-moving scenes or scenes with extreme changes of brightness, set to “THR” or “TXP” during 3D mode or “UXP” or “XP” during 2D mode.
- Use an external Blu-ray drive to save videos recorded in “UXP” mode.
- You can change to the desired video quality by tapping on it from the remaining recording time display.

For customers who completed the firmware update :

- Video quality cannot be set in the 3D mode (AVCHD 3D).

Displaying the Item

1 Select video mode.

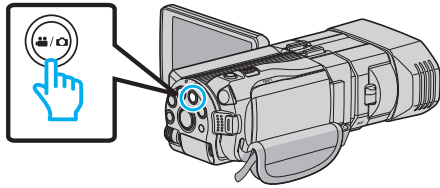

2 Tap to select the recording mode.



3 Tap "MENU".

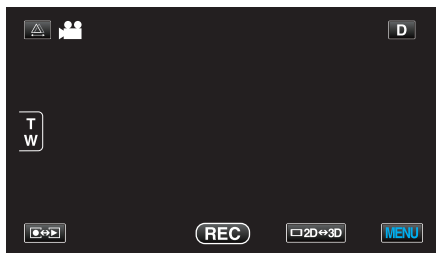

4 Tap "VIDEO QUALITY".



ZOOM (2D mode only)

Sets the maximum zoom ratio.

Setting	Details
10x/OPTICAL	Enables recording with 1 - 10x optical zoom. Set this when digital zoom is not desired.
40x/DIGITAL	Enables recording with 1 - 10x optical zoom and 11 - 40x digital zoom.
200x/DIGITAL	Enables recording with 1 - 10x optical zoom and 11 - 200x digital zoom.

Memo :

- When digital zoom is used, the image becomes grainy as it is digitally enlarged.

Displaying the Item

1 Select video mode.

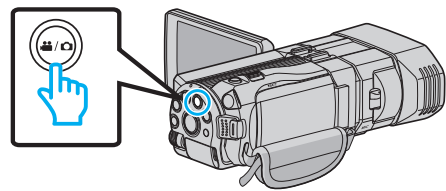

2 Tap to select the recording mode.



3 Tap "MENU".

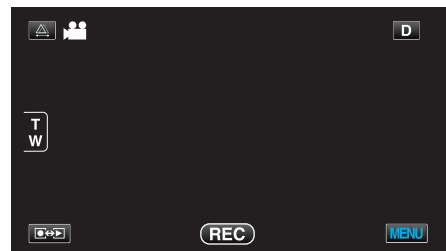

4 Tap "ZOOM".

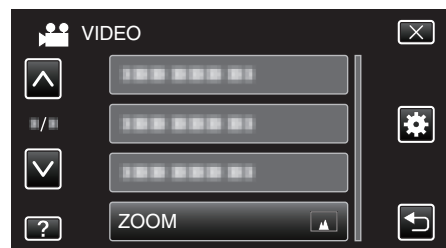

Menu Settings

x.v.Color (2D mode only)

Captures the true colors.
(Use an x.v.Color compatible TV for playback.)

Setting	Details
OFF	Captures colors with the same standard as TV broadcasting.
ON	Captures the true colors. (for TVs that supports x.v.Color)

Displaying the Item

- 1 Select video mode.

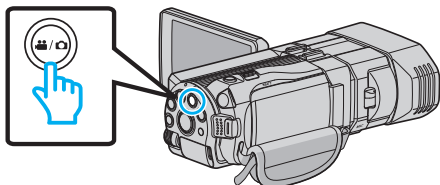

- 2 Tap to select the recording mode.



- 3 Tap "MENU".

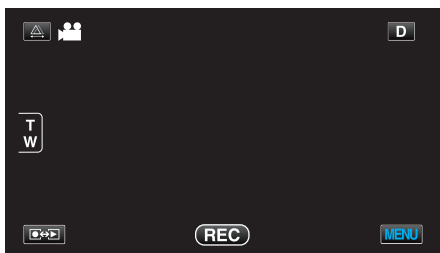

- 4 Tap "x.v.Color".

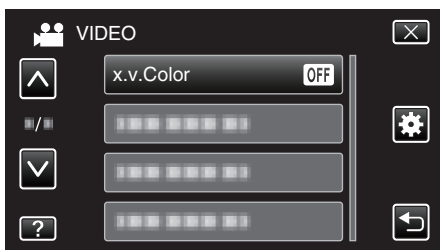

3D SOUND

Records realistic audio sounds.

Setting	Details
OFF	Does not record with 3D sound effects.
ON	Records with 3D sound effects.

Displaying the Item

- 1 Select video mode.

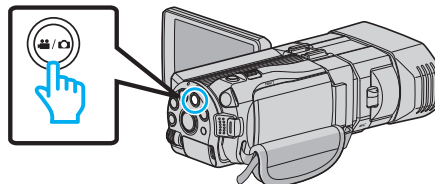

- 2 Tap to select the recording mode.



- 3 Tap "MENU".

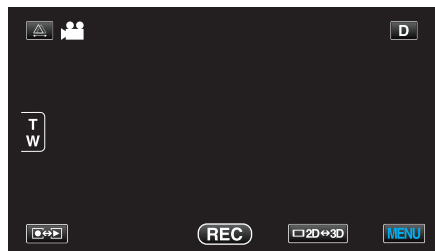

- 4 Tap "3D SOUND".

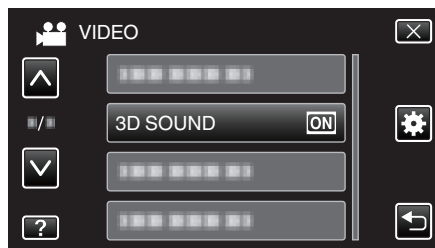

USER BUTTON SETTING

Assigns a frequently used function to the USER button.

Operating Details

"Setting the USER Button" (p. 43)

MIC LEVEL

Make the adjustments such that "MIC LEVEL" does not turn red.

Setting	Details
OFF	Hides display of microphone input level.
ON	Shows display of microphone input level.

Caution :

- When "3D VIDEO REC FORMAT" is set to "MP4(MVC)" and recording is performed together with HDMI output, the microphone input level will not be displayed. (It will be displayed after recording stops.)

Displaying the Item

- 1 Select video mode.

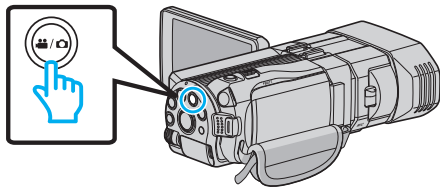

- 2 Tap to select the recording mode.



- 3 Tap "MENU".

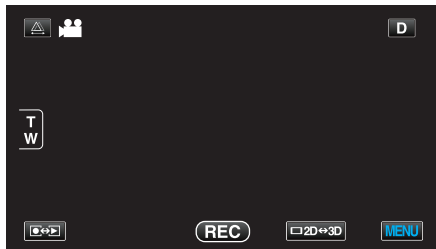

- 4 Tap "MIC LEVEL".

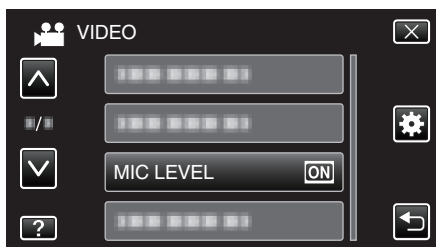

MIC LEVEL SETTING

Sets the microphone level.

Make the adjustments such that "MIC LEVEL" does not turn red.

Setting	Details
+2	Increases the microphone input level.
+1	Increases the microphone input level slightly.
0	The microphone input level is not changed.
-1	Decreases the microphone input level slightly.
-2	Decreases the microphone input level.

Displaying the Item

- 1 Select video mode.

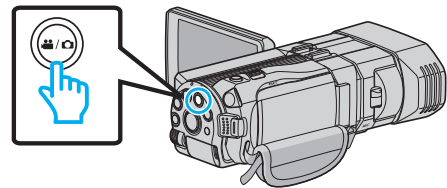

- 2 Tap to select the recording mode.



- 3 Tap "MENU".

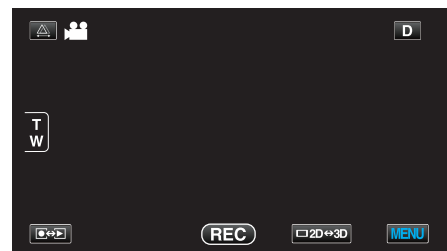

- 4 Tap "MIC LEVEL SETTING".

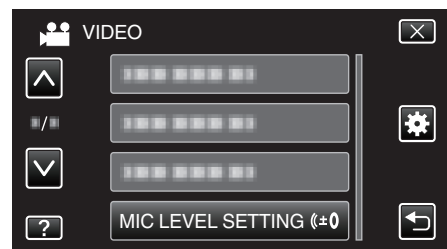

Menu Settings

HEADPHONE VOL. ADJ.

Sets the volume level of the connected headphones.

Adjusting the Volume Level of Headphones During Recording

1 Select video mode.

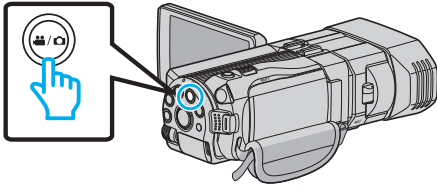

2 Tap  to select the recording mode.



3 Tap "MENU".

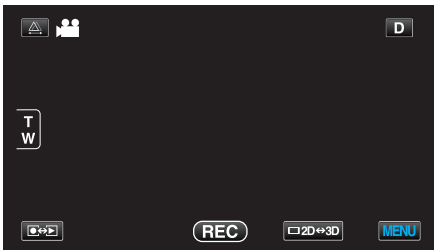

4 Tap "HEADPHONE VOL. ADJ.".

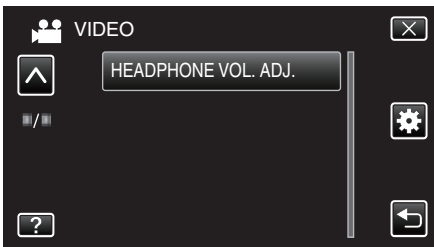

- The volume adjustment screen appears.

5 Adjust the volume level of the headphones.



- To turn up the volume, tap "+" on the touch screen.
- To turn down the volume, tap "-" on the touch screen.
- Tap X to exit the volume adjustment screen.

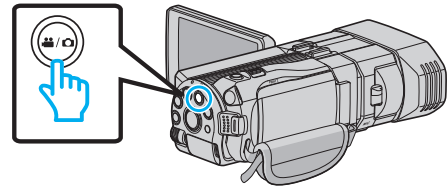

2 Tap  to select the playback mode.



3 Adjust the volume level of the headphones.

- To turn up the volume, set the zoom lever to the T end.
- To turn down the volume, set the zoom lever to the W end.

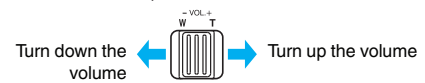

Adjusting the Volume Level of Headphones During Playback

1 Select video mode.

Main Menu for Still Image Recording

You can adjust various settings, such as brightness and white balance, to suit the subject or purpose. You can also change settings such as picture quality and gain.

- 1 Select still image mode.

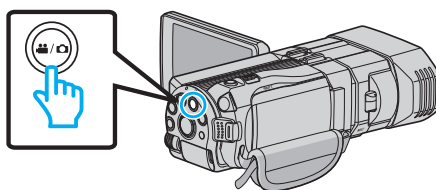

- 2 Tap  to select the recording mode.



- 3 Tap "MENU".

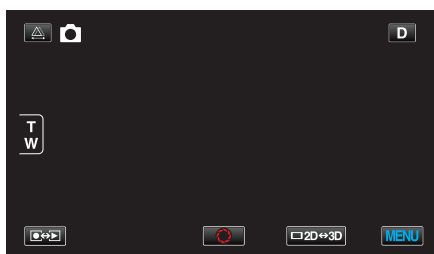

Setting	Details
SCENE SELECT	Settings to suit the shooting condition can be selected. "Scene Selection" (☞ p. 37) *Displayed only in the manual recording mode.
FOCUS	Focus can be adjusted manually. "Adjusting Focus Manually" (☞ p. 38) *Displayed only in the manual recording mode.
FOCUS ASSIST	Focused subject is outlined in color for more precise focus. "Using Focus Assist" (☞ p. 39) *Displayed only in the manual recording mode.
FOCUS ASSIST COLOR	Sets the color of the outline of a focused object when Focus Assist is used. "FOCUS ASSIST COLOR" (☞ p. 115) *Displayed only in the manual recording mode.
BRIGHTNESS ADJUST	Adjusts the overall brightness of the screen. "Adjusting Brightness" (☞ p. 39) *Displayed only in the manual recording mode.
SHUTTER SPEED	Shutter speed can be adjusted. "Setting Shutter Speed" (☞ p. 40) *Displayed only in the manual recording mode.
APERTURE PRIORITY	Adjusts the aperture value. "Setting Aperture" (☞ p. 40) *Displayed only in the manual recording mode.
WHITE BALANCE	Adjusts the color according to the light source. "Setting White Balance" (☞ p. 41) *Displayed only in the manual recording mode.

Menu Settings

Setting	Details
BACKLIGHT COMP.	Corrects the image when the subject appears dark due to backlight. “Setting Backlight Compensation” (☞ p. 42) *Displayed only in the manual recording mode.
TELE MACRO	Enables close-up shots when using the telephoto (T) end of the zoom. “Taking Close-up Shots” (☞ p. 42) *Displayed only in the 2D manual recording mode.
TOUCH PRIORITY AE/AF	Automatically adjusts focus and brightness based on the subjects' faces or selected area. “Capturing Subjects Clearly (TOUCH PRIORITY AE/AF)” (☞ p. 45)
SMILE SHOT	Automatically captures a still image upon detection of a smile. “Capturing Smiles Automatically (SMILE SHOT)” (☞ p. 46)
SMILE LEVEL	Sets the items to display when faces are detected. “Setting SMILE LEVEL Display (Still image only)” (☞ p. 47)
SELF-TIMER	Use this when taking a group photo. “Taking Group Shots (Self-timer)” (☞ p. 49)
GAIN UP	Makes the subject appear bright automatically when recording in dark places. “GAIN UP” (☞ p. 116)
GRID	Displays gridlines to make it easier to detect when the subject appears slanted. “GRID” (☞ p. 116)
SHUTTER MODE	Continuous shooting settings can be adjusted. “SHUTTER MODE” (☞ p. 117)
CONT. SHOOTING SPEED	Sets the speed for continuous shooting. “CONT. SHOOTING SPEED” (☞ p. 117)
IMAGE SIZE	Sets the image size (number of pixels) for still images. “IMAGE SIZE” (☞ p. 118) *Displayed only in the 2D recording mode.
USER BUTTON SETTING	Assigns a frequently used function to the USER button. “Setting the USER Button” (☞ p. 43)

SCENE SELECT

Settings to suit the shooting condition can be selected.
 Operating Details
 "Scene Selection" (☞ p. 37)

FOCUS

Focus can be adjusted manually.
 Operating Details
 "Adjusting Focus Manually" (☞ p. 38)

FOCUS ASSIST

Focused subject is outlined in color for more precise focus.
 Operating Details
 "Using Focus Assist" (☞ p. 39)

FOCUS ASSIST COLOR

Sets the color of the outline of a focused object when Focus Assist is used.

Setting	Details
RED	Outlines the focused object in red.
GREEN	Outlines the focused object in green.
BLUE	Outlines the focused object in blue.

Displaying the Item

1 Select still image mode.

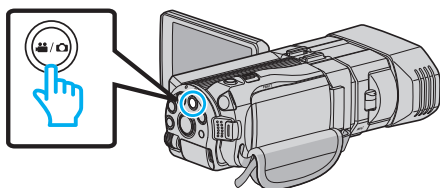

2 Tap to select the recording mode.



3 Tap "MENU".

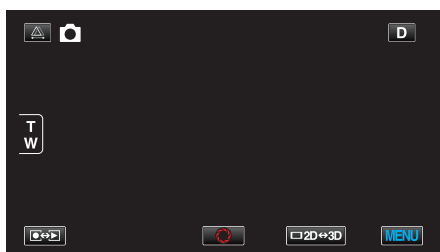

4 Tap "FOCUS ASSIST COLOR".

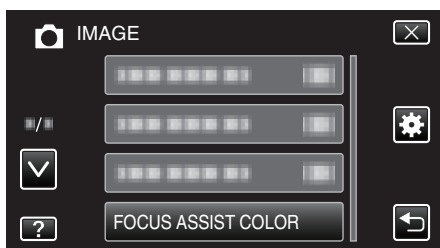

BRIGHTNESS ADJUST

Adjusts the overall brightness of the screen.
 Operating Details
 "Adjusting Brightness" (☞ p. 39)

SHUTTER SPEED

Shutter speed can be adjusted.
 Operating Details
 "Setting Shutter Speed" (☞ p. 40)

APERTURE PRIORITY

Adjusts the aperture value.
 Operating Details
 "Setting Aperture" (☞ p. 40)

WHITE BALANCE

Adjusts the color according to the light source.
 Operating Details
 "Setting White Balance" (☞ p. 41)

BACKLIGHT COMP.

Corrects the image when the subject appears dark due to backlight.
 Operating Details
 "Setting Backlight Compensation" (☞ p. 42)

TELE MACRO (2D mode only)

Enables close-up shots when using the telephoto (T) end of the zoom.
 Operating Details
 "Taking Close-up Shots" (☞ p. 42)

TOUCH PRIORITY AE/AF

Automatically adjusts focus and brightness based on the subjects' faces or selected area.
 Operating Details
 "Capturing Subjects Clearly (TOUCH PRIORITY AE/AF)" (☞ p. 45)

SMILE SHOT

Automatically captures a still image upon detection of a smile.
 Operating Details
 "Capturing Smiles Automatically (SMILE SHOT)" (☞ p. 46)

SMILE LEVEL

Sets the items to display when faces are detected.
 Operating Details
 "Setting SMILE LEVEL Display (Still image only)" (☞ p. 47)

SELF-TIMER

Use this when taking a group photo.
 Operating Details
 "Taking Group Shots (Self-timer)" (☞ p. 49)

Menu Settings

GAIN UP

Makes the subject appear bright automatically when recording in dark places.

Setting	Details
OFF	Deactivates the function.
ON	Electrically brightens the scene when it is dark.

Memo :

- Setting can be adjusted separately for videos.
- “GAIN UP (Video)” (p. 106)

Displaying the Item

- 1 Select still image mode.

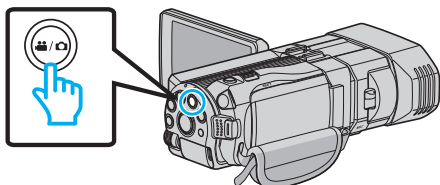

- 2 Tap to select the recording mode.



- 3 Tap “MENU”.

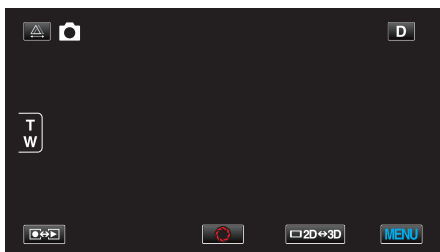

- 4 Tap “GAIN UP”.

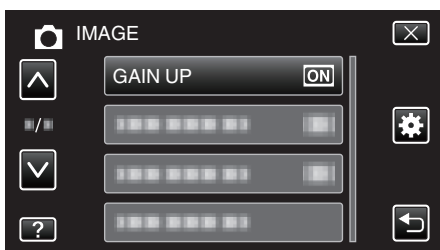

GRID

Displays gridlines to make it easier to detect when the subject appears slanted.

Setting	Details
OFF	Turns off grid display.
ON	Turns on grid display.

Displaying the Item

- 1 Select still image mode.

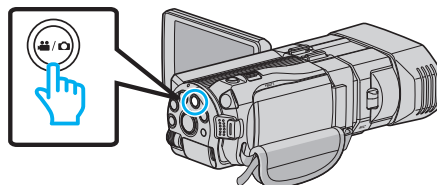

- 2 Tap to select the recording mode.



- 3 Tap “MENU”.

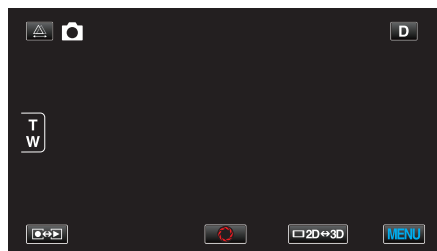

- 4 Tap “GRID”.

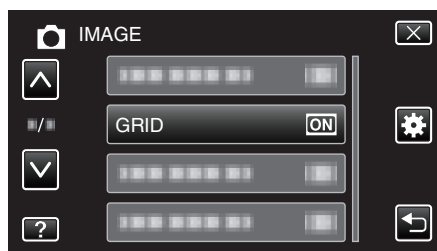

SHUTTER MODE

Continuous shooting settings can be adjusted.

Setting	Details
RECORD ONE SHOT	Records one still image.
CONTINUOUS SHOOTING	Records still images continuously while the SNAPSHOT button is pressed.

Memo :

- You can change the continuous shooting speed with “CONT. SHOOTING SPEED” in the “COMMON” menu.
- “CONT. SHOOTING SPEED” (p. 117)
- Some SD cards may not support continuous shooting.
- The continuous shooting speed will drop if this function is used repeatedly.

Displaying the Item

- 1 Select still image mode.

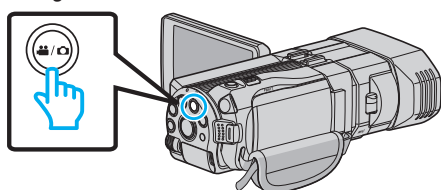

- 2 Tap to select the recording mode.



- 3 Tap “MENU”.

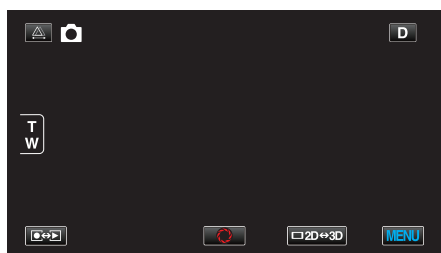

- 4 Tap “SHUTTER MODE”.

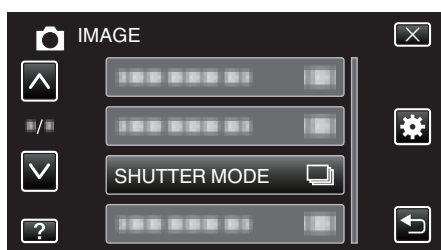

CONT. SHOOTING SPEED

Sets the speed for continuous shooting.

Setting	Details
HIGH SPEED	<ul style="list-style-type: none"> • Shoots up to 12 still images continuously in the 3D still image mode at approximately 12 images/second. • Shoots up to 40 still images continuously in the 2D still image mode at approximately 12 images/second.
LOW SPEED	Shoots continuously until the recording media is full.

Memo :

- Shooting speed slows down gradually as continuous shooting goes on in the “LOW SPEED” mode.

Displaying the Item

- 1 Select still image mode.

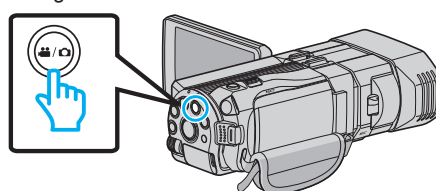

- 2 Tap to select the recording mode.



- 3 Tap “MENU”.

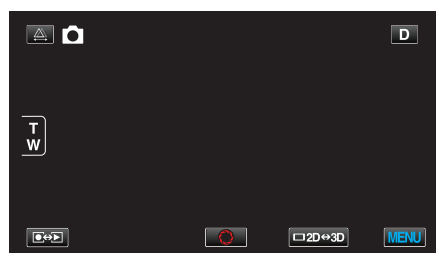

- 4 Tap “CONT. SHOOTING SPEED”.

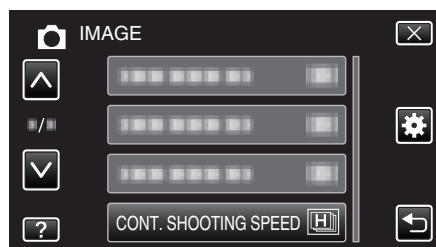

Menu Settings

IMAGE SIZE

Sets the image size (number of pixels) for still images.

■ 3D Mode

Setting	Details
1920X1080(2M) (16:9)	Takes still images with aspect ratio 16:9.

Memo :

- During 3D mode, IMAGE SIZE is fixed at 1920X1080(2M) (16:9) and cannot be changed.
- When still images are captured in the 3D mode, they will be saved in both 3D and 2D formats. IMAGE SIZE of both the 3D and 2D images will be set to 1920X1080(2M) (16:9).

■ 2D Mode

Setting	Details
2304X1296(2.9M) 1920X1080(2M) (16:9)	Takes still images with aspect ratio 16:9. <ul style="list-style-type: none">• The sides of still images recorded in 16:9 aspect ratio may be cut off when printed.
1728X1296(2.2M) 640X480(0.3M) (4:3)	Takes still images with aspect ratio 4:3.

Displaying the Item

- 1 Select still image mode.

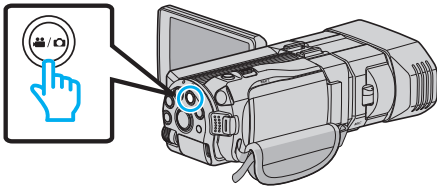

- 2 Tap  to select the recording mode.



- 3 Tap "MENU".

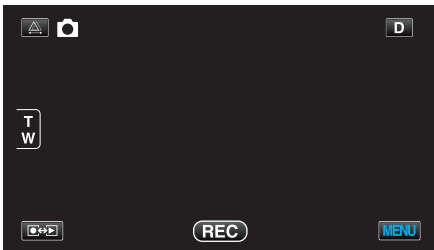

- 4 Tap "IMAGE SIZE".



USER BUTTON SETTING

Assigns a frequently used function to the USER button.

Operating Details

"Setting the USER Button" (p. 43)

Main Menu for Video Playback

You can delete or look for specific videos.

- 1 Select video mode.

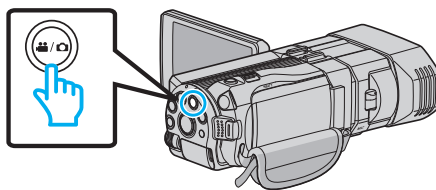

- 2 Tap  to select the playback mode.

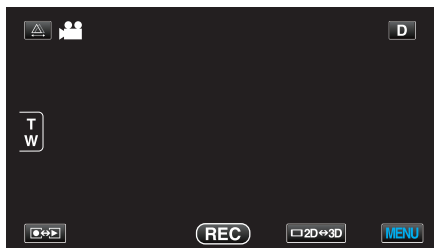

- 3 Tap "MENU".



Setting	Details
SEARCH DATE	Narrows down the video index screen according to recording dates. "SEARCH DATE" (☞ p. 120)
PROTECT/CANCEL	Protects files from being deleted accidentally. "Protecting/Releasing Protection of the Currently Displayed File" (☞ p. 68) "Protecting/Releasing Protection of Selected Files" (☞ p. 68)
COPY	Copies files from the built-in memory to the SD card. "COPY" (☞ p. 120)
MOVE	Moves files from the built-in memory to the SD card. "MOVE" (☞ p. 120)
TRIMMING	Select the required part of a video and save it as a new video file. "Capturing a Required Part in the Video (TRIMMING)" (☞ p. 70)
UPLOAD SETTINGS	Capture and copy a part of a recorded video (maximum 15 minutes) for uploading to YouTube. "UPLOAD SETTINGS" (☞ p. 120)
PLAYBACK OTHER FILE	Plays videos with defective management information. "Playing a Video with Defective Management Information" (☞ p. 55)
3D MOTION RELIEF	Plays back in stop-motion the scenes that are likely to cause motion sickness to prevent its occurrence. "3D MOTION RELIEF (3D mode only)" (☞ p. 120) *Displayed only in the 3D playback mode.

Menu Settings

SEARCH DATE

Narrows down the video index screen according to recording dates.

Operating Details

“Date Search” (☞ p. 59)

PROTECT/CANCEL

Protects files from being deleted accidentally.

Operating Details

“Protecting/Releasing Protection of the Currently Displayed File” (☞ p. 68)

“Protecting/Releasing Protection of Selected Files” (☞ p. 68)

COPY

Copies files from the built-in memory to the SD card.

Operating Details

“Copying Files to an SD Card” (☞ p. 92)

MOVE

Moves files from the built-in memory to the SD card.

Operating Details

“Moving Files to an SD Card” (☞ p. 93)

TRIMMING

Select the required part of a video and save it as a new video file.

Operating Details

“Capturing a Required Part in the Video (TRIMMING)” (☞ p. 70)

UPLOAD SETTINGS

Capture and copy a part of a recorded video (maximum 15 minutes) for uploading to YouTube.

Operating Details

“Capturing Videos for Uploading to YouTube” (☞ p. 71)

PLAYBACK OTHER FILE

Plays videos with defective management information.

Operating Details

“Playing a Video with Defective Management Information” (☞ p. 55)

3D MOTION RELIEF (3D mode only)

Plays back in stop-motion the scenes that are likely to cause motion sickness to prevent its occurrence.

Setting	Details
OFF	Plays back normally even for the scenes that are likely to cause motion sickness.
ON	Plays back in stop-motion the scenes that are likely to cause motion sickness.

Displaying the Item

- 1 Select video mode.

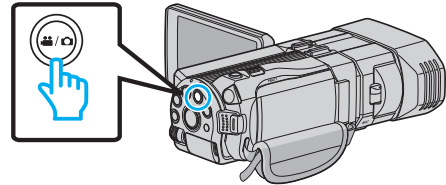

- 2 Tap  to select the playback mode.

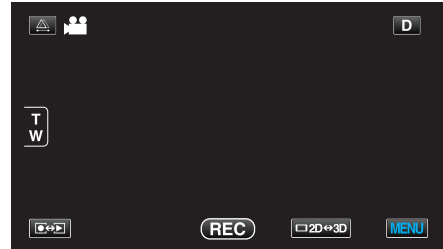

- 3 Tap “MENU”.



- 4 Tap “3D MOTION RELIEF”.



Memo :

To avoid recording scenes that will be played back in stop-motion, refer to “Precautions on Recording and Playing Back 3D Images”.

“Precautions on Recording and Playing Back 3D Images” (☞ p. 11)

Main Menu for Still Image Playback

You can delete or look for specific still images.

- 1 Select still image mode.

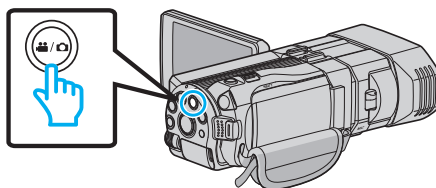

- 2 Tap  to select the playback mode.

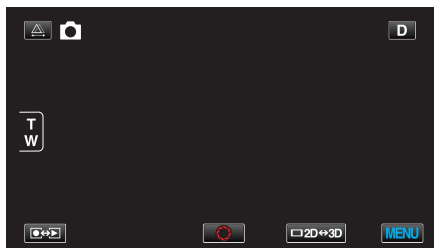

- 3 Tap "MENU".



Setting	Details
SEARCH DATE	Narrows down the still image index screen according to recording dates. "Date Search" (☞ p. 59)
PROTECT/CANCEL	Protects files from being deleted accidentally. "Protecting/Releasing Protection of the Currently Displayed File" (☞ p. 68) "Protecting/Releasing Protection of Selected Files" (☞ p. 68)
COPY	Copies files from the built-in memory to the SD card. "COPY" (☞ p. 121)
MOVE	Moves files from the built-in memory to the SD card. "MOVE" (☞ p. 121)

SEARCH DATE

Narrows down the still image index screen according to recording dates.

Operating Details

"Date Search" (☞ p. 59)

PROTECT/CANCEL

Protects files from being deleted accidentally.

Operating Details

"Protecting/Releasing Protection of the Currently Displayed File" (☞ p. 68)

"Protecting/Releasing Protection of Selected Files" (☞ p. 68)

COPY

Copies files from the built-in memory to the SD card.

Operating Details

"Copying Files to an SD Card" (☞ p. 92)

MOVE

Moves files from the built-in memory to the SD card.

Operating Details

"Moving Files to an SD Card" (☞ p. 93)

Common Menu

1 Select video or still image mode.

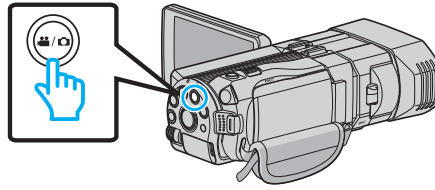

2 Tap "MENU".

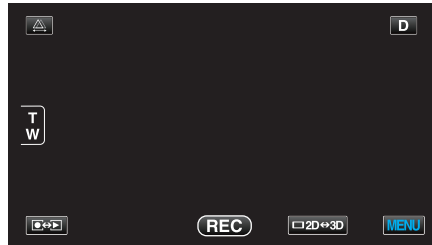

3 Tap "⚙️".



Setting	Details
CLOCK ADJUST	Resets the current time or sets to the local time when using this unit overseas. "Clock Setting" (☞ p. 19) "Setting the Clock to Local Time when Traveling" (☞ p. 25) "Setting Daylight Saving Time" (☞ p. 25)
DATE DISPLAY STYLE	Sets the order of year, month, day and the time display format (24H/12H). "DATE DISPLAY STYLE" (☞ p. 124)
LANGUAGE	The language on the display can be changed. "Changing the Display Language" (☞ p. 21)
MONITOR BRIGHTNESS	Sets the brightness of the LCD monitor. "MONITOR BRIGHTNESS" (☞ p. 125)
REC MEDIA FOR VIDEO	Sets the recording/playback media of videos. "REC MEDIA FOR VIDEO" (☞ p. 125)
REC MEDIA FOR IMAGE	Sets the recording/playback media of still images. "REC MEDIA FOR IMAGE" (☞ p. 126)
OPERATION SOUND	Turns on or off the operation sound. "OPERATION SOUND" (☞ p. 126)
AUTO POWER OFF	Prevents the situation of forgetting to turn off the power when this is set. "AUTO POWER OFF" (☞ p. 127)
QUICK RESTART	Reduces the power consumption within 5 minutes after the LCD monitor is closed to 1/3 of that used during recording. "QUICK RESTART" (☞ p. 127)
REMOTE	Enables remote control operation. "REMOTE" (☞ p. 128)

Setting	Details
DEMO MODE	Introduces the special features of this unit in digest form. "DEMO MODE" (p. 128)
TOUCH SCREEN ADJUST	Adjusts the response position of the buttons on the touch screen. "TOUCH SCREEN ADJUST" (p. 129)
3D DISPLAY WARNING (3D mode only)	Sets whether to display warnings during 3D playback. "3D DISPLAY WARNING (3D mode only)" (p. 130)
VIDEO OUTPUT (2D mode only)	Sets the aspect ratio (16:9 or 4:3) according to the connecting TV. "VIDEO OUTPUT (2D mode only)" (p. 130)
HDMI OUTPUT	Sets the definition of the video output from the HDMI mini connector. "HDMI OUTPUT" (p. 131)
HDMI CONTROL	Sets the linked operations ON/OFF when the TV and this unit are connected using the HDMI mini connector. "HDMI CONTROL" (p. 132)
AUTO FINALIZE	Finalizes the discs created automatically so that they can be played back on compatible devices. "AUTO FINALIZE" (p. 133)
FACTORY PRESET	Returns all the settings to their default values. "FACTORY PRESET" (p. 133)
UPDATE	Updates the functions of this unit to the latest version. "UPDATE" (p. 133)
FORMAT BUILT-IN MEM.	Deletes all files on the built-in memory. "FORMAT BUILT-IN MEM." (p. 134)
FORMAT SD CARD	Deletes all files on the SD card. "FORMAT SD CARD" (p. 134)
ERASE ALL DATA	Execute this process when disposing of this unit or passing it to another person. "ERASE ALL DATA" (p. 135)

Menu Settings

CLOCK ADJUST

Resets the current time or sets to the local time when using this unit overseas.

Operating Details

“Clock Setting” (p. 19)

“Setting the Clock to Local Time when Traveling” (p. 25)

“Setting Daylight Saving Time” (p. 25)

DATE DISPLAY STYLE

Sets the order of year, month, day and the time display format (24H/12H).

1 Tap “MENU”.

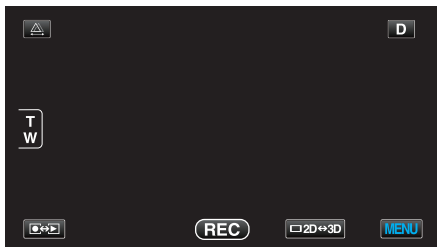

2 Tap “⚙️”.



3 Tap “DATE DISPLAY STYLE”.

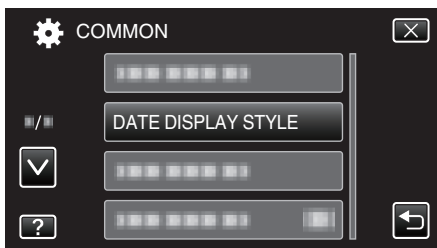

4 Tap to set the style of date and time display.

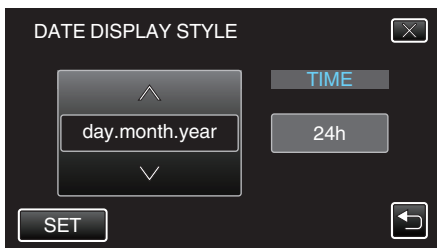

- Tap the bottom of “DATE STYLE”, then tap \wedge or \vee to set the order of year, month, and day.
- Tap the bottom of TIME, then tap \wedge or \vee to set the time display format.
- For date display, set to any format from “month.day.year”, “year.month.day”, and “day.month.year”.
- For time display, set to any format from “12h” and “24h”.
- After setting, tap “SET”. This confirms the setting of the order of year, month, day and the time display format.
- To cancel the setting, tap “X” or “↶”.

Clock Set Style

The clock set style of this unit varies with the models.

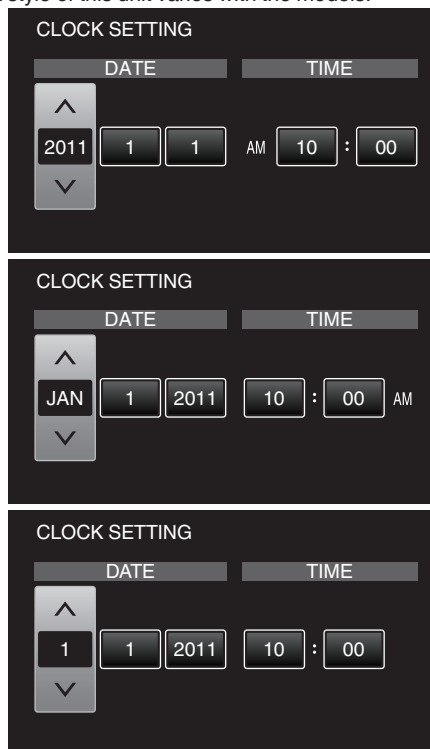

- The order of “Year, Month, Day, Time” changes according to the date display style.

LANGUAGE

The language on the display can be changed.
 Operating Details
 “Changing the Display Language” (p. 21)

MONITOR BRIGHTNESS

Sets the brightness of the LCD monitor.

Setting	Details
4	Brightens the backlight of the monitor regardless of the surrounding conditions.
3	Sets to the standard brightness.
2	Darkens the backlight of the monitor regardless of the surrounding conditions.
1	Sets to dim brightness. Helps to save battery life when selected.
AUTO	Sets the brightness automatically to “4” when using outdoors and to “3” when using indoors.

Displaying the Item

1 Tap “MENU”.

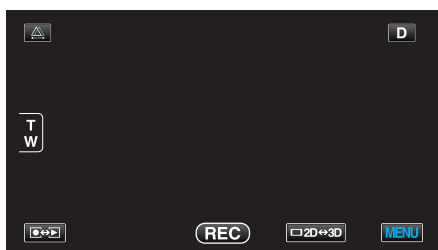

2 Tap .



3 Tap “MONITOR BRIGHTNESS”.

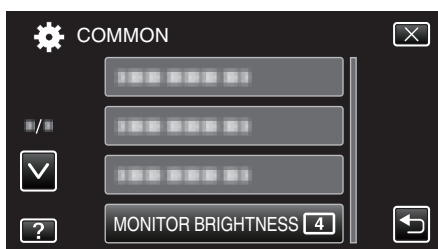

REC MEDIA FOR VIDEO

Sets the recording/playback media of videos.

Setting	Details
BUILT-IN MEMORY	Records videos to this unit's built-in memory.
SD CARD	Records videos to the SD card.

Displaying the Item

1 Tap “MENU”.

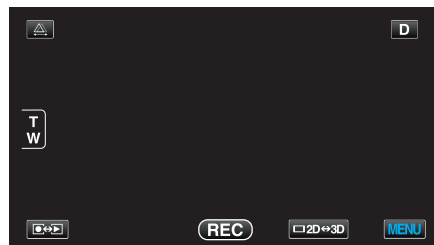

2 Tap .



3 Tap “REC MEDIA FOR VIDEO”.

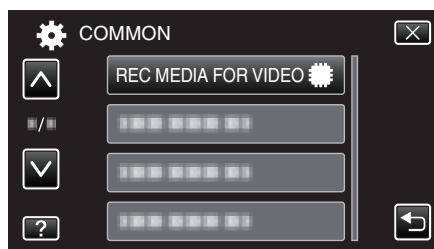

Menu Settings

REC MEDIA FOR IMAGE

Sets the recording/playback media of still images.

Setting	Details
BUILT-IN MEMORY	Records still images to this unit's built-in memory.
SD CARD	Records still images to the SD card.

Displaying the Item

- 1 Tap "MENU".



- 2 Tap "⚙️".



- 3 Tap "REC MEDIA FOR IMAGE".

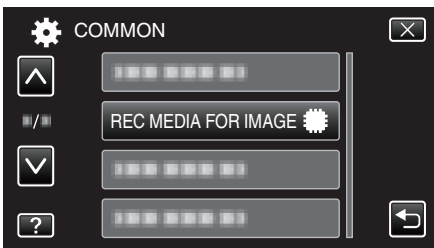

OPERATION SOUND

Turns on or off the operation sound.

Setting	Details
OFF	Turns off the operation sound.
ON	Turns on the operation sound.

Displaying the Item

- 1 Tap "MENU".

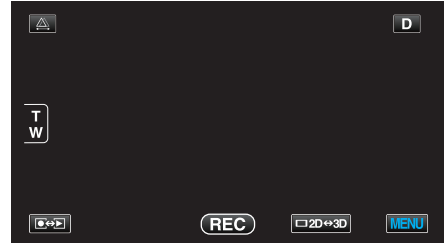

- 2 Tap "⚙️".



- 3 Tap "OPERATION SOUND".

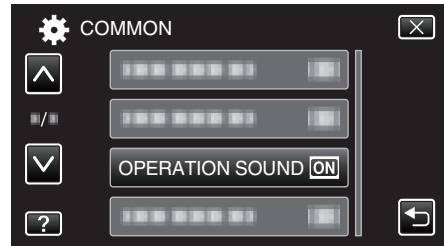

AUTO POWER OFF

Prevents the situation of forgetting to turn off the power when this is set.

Setting	Details
OFF	Power is not turned off even if this unit is not operated for 5 minutes.
ON	Turns off the power automatically if this unit is not operated for 5 minutes.

Memo :

- When using battery, power is turned off automatically if this unit is not operated for 5 minutes.
- When using the AC adapter, this unit goes into standby mode.

Displaying the Item

1 Tap "MENU".

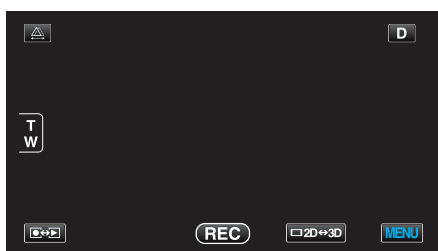

2 Tap "⚙️".



3 Tap "AUTO POWER OFF".

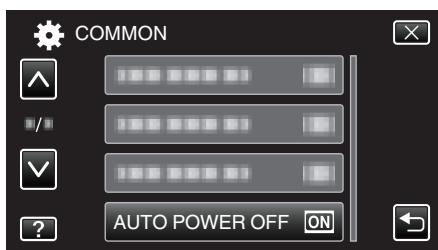

QUICK RESTART

Enables the power to turn on quickly when the LCD monitor is opened again within 5 minutes.

Setting	Details
OFF	Deactivates the function.
ON	Enables the power to turn on quickly when the LCD monitor is opened again within 5 minutes.

Memo :

- The power consumption within 5 minutes after the LCD monitor is closed is reduced.

Displaying the Item

1 Tap "MENU".

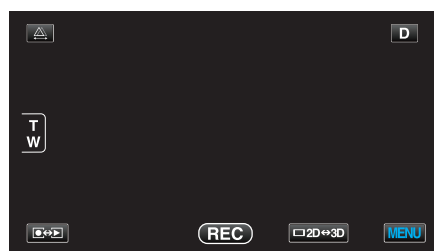

2 Tap "⚙️".

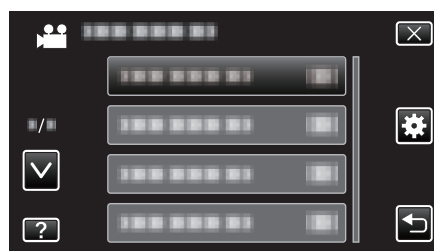

3 Tap "QUICK RESTART".

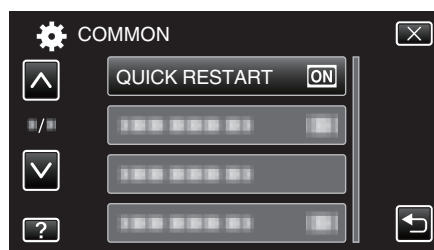

- The power consumption within 5 minutes after the LCD monitor is closed is reduced.

Menu Settings

REMOTE

Enables remote control operation.

Setting	Details
OFF	Disables remote control operation.
ON	Enables remote control operation.

Displaying the Item

- 1 Tap "MENU".



- 2 Tap "⚙️".



- 3 Tap "REMOTE".

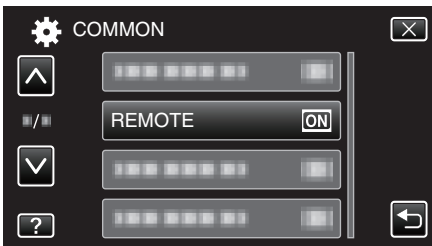

DEMO MODE

Plays a demonstration of the special features of this unit.

Setting	Details
OFF	Deactivates the function.
ON	Plays a demonstration of the special features of this unit.

Displaying Demo Mode

- 1 Remove the battery pack and SD card.
 - 2 Connect the AC adapter.
 - 3 Open the LCD monitor and turn on the power.
- Demonstration starts playing after 3 minutes.
 - To stop playback, tap on the screen.

Memo :

- This mode is not available in the playback mode.

Displaying the Item

- 1 Tap "MENU".

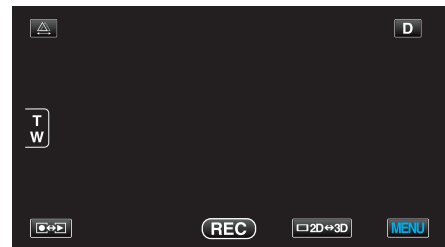

- 2 Tap "⚙️".



- 3 Tap "DEMO MODE".

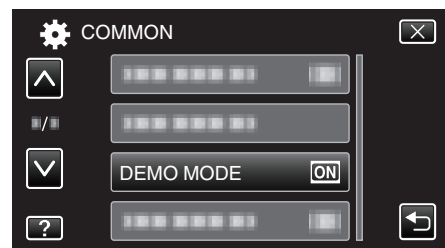

TOUCH SCREEN ADJUST

Adjusts the response position of the buttons on the touch screen.

- 1 Tap "MENU".

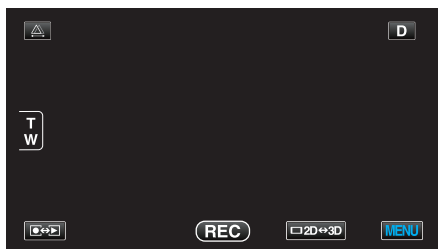

- 2 Tap "⚙️".



- 3 Tap "TOUCH SCREEN ADJUST".

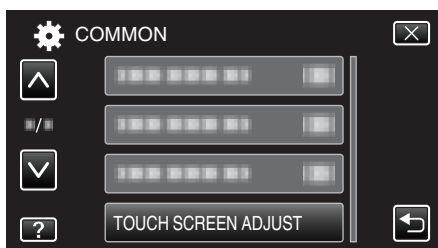

- The touch screen adjustment screen appears.

- 4 Tap "+". (3 times in total)

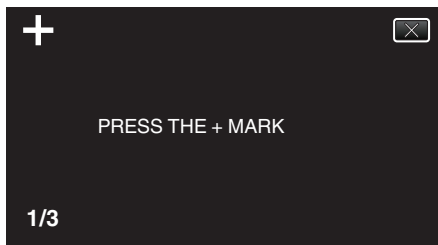

- Keep tapping "+" as its position changes with every tap.

- 5 Tap "+" again to confirm the adjusted positions. (3 times in total)

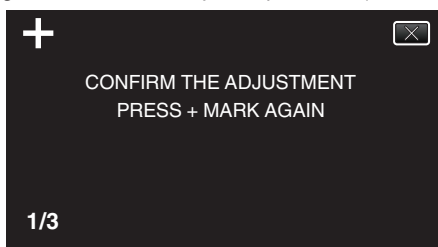

- Keep tapping "+" as its position changes with every tap.
- If areas on the adjustment screen other than the "+" mark are tapped, errors will occur. In this case, try again from step 4.

- 6 Tap "OK".

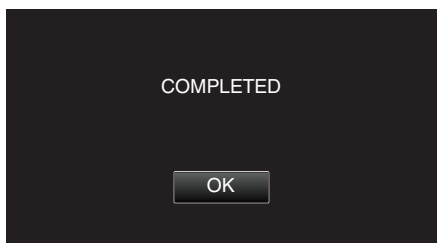

- Setting ends and returns to the menu screen.

Caution :

- Do not tap areas other than the "+" mark during touch screen adjustment (steps 4 - 5). Doing so may cause the touch screen to malfunction.

Memo :

- Adjust by lightly tapping with a corner of an SD card, etc.
- Do not press with an object with a sharp tip or do not press hard.

Menu Settings

3D DISPLAY WARNING (3D mode only)

Sets whether to display warnings during 3D playback.

Setting	Details
OFF	Shows a 3D warning icon (*) instead of the 3D warning message.
ON	Shows a 3D warning message at a regular interval.

*3D warning icon: 

Displaying the Item

- 1 Tap "MENU".



- 2 Tap "⚙️".



- 3 Tap "3D DISPLAY WARNING".

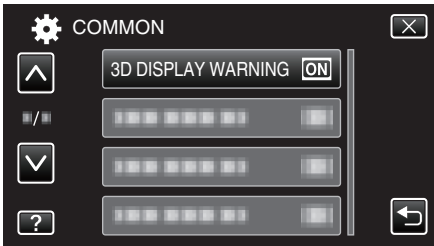

VIDEO OUTPUT (2D mode only)

Sets the aspect ratio (4:3 or 16:9) according to the connecting TV.

Setting	Details
4:3	Select this when connecting to a conventional TV (4:3).
16:9	Select this when connecting to a widescreen TV (16:9).

Displaying the Item

- 1 Tap "MENU".



- 2 Tap "⚙️".



- 3 Tap "VIDEO OUTPUT".

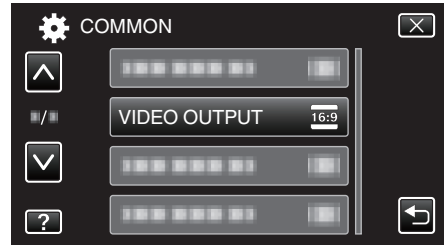

HDMI OUTPUT

Sets the output from the HDMI connector of this unit when it is connected to a TV.

3D Mode

Setting	Details
AUTO	Output images according to the supported monitor output format.
SIDE-BY-SIDE OUTPUT	Outputs images from the HDMI connector in "SIDE-BY-SIDE OUTPUT" (960x1080i x2ch) regardless of the supported monitor output format.
CERTAIN TV TYPES	Outputs images from the HDMI connector in "SIDE-BY-SIDE OUTPUT" (960x1080i x2ch) if the format "1080i" is supported by the monitor. Outputs images from the HDMI connector in "2D" (576p or 576i) if "1080i" is not supported by the monitor.
2D OUTPUT	Outputs images from the HDMI connector in "2D" ("1080i", "576p", or "576i") regardless of the supported monitor output format.

Recorded 3D Video Format and Display on TV via HDMI Output**■ When HDMI OUTPUT is set to "2D OUTPUT"**

3D VIDEO REC FORMAT	Video Output		
	2D TV	3D Compatible TV	LCD Monitor of this Unit
AVCHD	2D	2D	3D
MP4(MVC)	2D	2D	3D

■ When HDMI OUTPUT is set to "AUTO"

3D VIDEO REC FORMAT	Video Output		
	2D TV	3D Compatible TV	LCD Monitor of this Unit
AVCHD	2D	3D	3D
MP4(MVC)	2D	3D	3D

- If 3D images cannot be seen even when connected to a 3D compatible TV, set "HDMI OUTPUT" to "CERTAIN TV TYPES" or "SIDE-BY-SIDE OUTPUT".
- If "HDMI OUTPUT" is set to "CERTAIN TV TYPES" when connected to a 2D TV, the left and right images will appear side by side.
- For details on the settings of your TV, refer to its instruction manual.

■ For customers who completed the firmware update**Recorded 3D Video Format and Display on TV via HDMI Output****■ When HDMI OUTPUT is set to "2D OUTPUT"**

3D VIDEO REC FORMAT	Video Output		
	2D TV	3D Compatible TV	LCD Monitor of this Unit
AVCHD 3D	2D	2D	3D
AVCHD	2D	2D	3D
MP4(MVC)	2D	2D	3D

■ When HDMI OUTPUT is set to "AUTO"

3D VIDEO REC FORMAT	Video Output		
	2D TV	3D Compatible TV	LCD Monitor of this Unit
AVCHD 3D	2D	3D	3D
AVCHD	2D	3D	3D
MP4(MVC)	2D	3D	3D

- If 3D images cannot be seen even when connected to a 3D compatible TV, set "HDMI OUTPUT" to "CERTAIN TV TYPES" or "SIDE-BY-SIDE OUTPUT".
- If "HDMI OUTPUT" is set to "CERTAIN TV TYPES" when connected to a 2D TV, the left and right images will appear side by side.
- For details on the settings of your TV, refer to its instruction manual.

2D Mode

Setting	Details
AUTO	It is recommended to select "AUTO" usually.
576p	Select this when the video is not output in "AUTO" correctly.

Displaying the Item

Menu Settings

- 1 Tap "MENU".



- 2 Tap "⚙️".



- 3 Tap "HDMI OUTPUT".

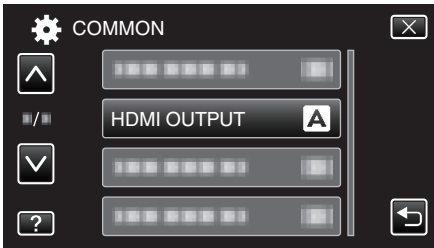

HDMI CONTROL

Sets whether to link operations with an HDMI-CEC compliant TV.

Setting	Details
OFF	Turns off linked operations.
ON	Turns on linked operations.

Displaying the Item

- 1 Tap "MENU".

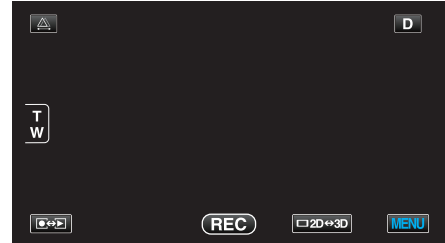

- 2 Tap "⚙️".



- 3 Tap "HDMI CONTROL".

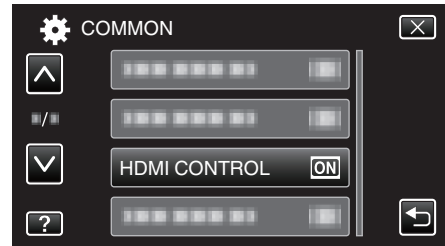

AUTO FINALIZE

Finalizes the discs created automatically so that they can be played back on compatible devices.

Setting	Details
OFF	Does not finalize the disc. Data can be added to the disc later.
ON	Finalizes the disc and sets it to a readable state.

Displaying the Item

1 Tap "MENU".

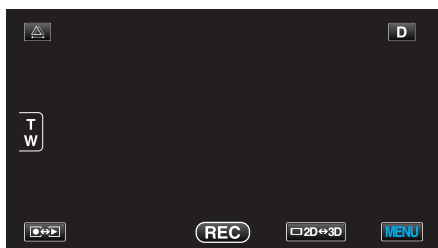

2 Tap "⚙️".

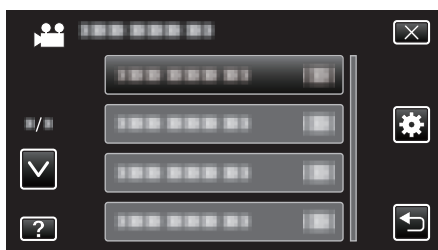

3 Tap "AUTO FINALIZE".

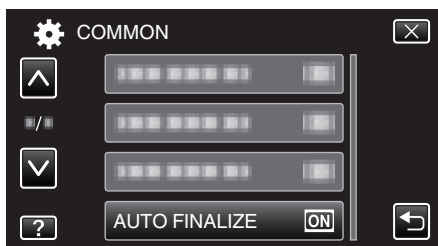

FACTORY PRESET

Returns all the settings to their default values.

1 Tap "MENU".

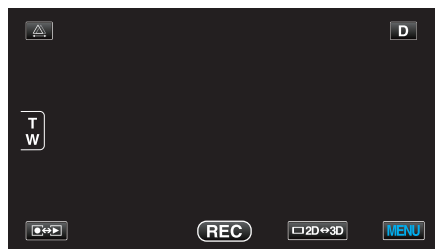

2 Tap "⚙️".



3 Tap "FACTORY PRESET".



4 Tap "YES".

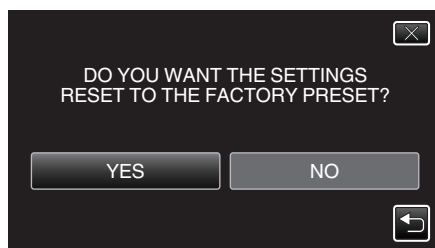

- All settings return to their default values.

UPDATE

Updates the functions of this unit to the latest version.

For details, refer to the JVC homepage.

(When no program to update the software of this unit is available, nothing will be provided on the homepage.)

<http://www3.jvckenwood.com/english/support/index.html>

Menu Settings

FORMAT BUILT-IN MEM.

Deletes all files on the built-in memory.

Setting	Details
FILE	Deletes all files on the built-in memory.
FILE + MANAGEMENT NO	Deletes all files on the built-in memory and resets the folder and file numbers to "1".

Caution :

- All data on the built-in memory will be deleted when it is formatted. Copy all files on the built-in memory to a PC before formatting.
- Make sure that the battery pack is fully charged or connect the AC adapter as the formatting process may take some time.

Displaying the Item

- 1 Tap "MENU".

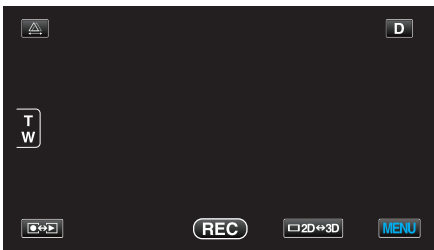

- 2 Tap "⚙️".



- 3 Tap "FORMAT BUILT-IN MEM.".

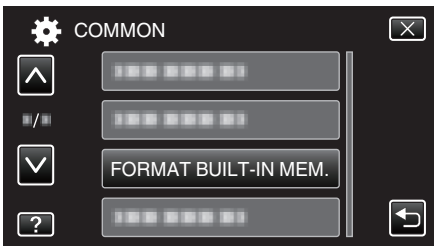

FORMAT SD CARD

Deletes all files on the SD card.

Setting	Details
FILE	Deletes all files on the SD card.
FILE + MANAGEMENT NO	Deletes all files on the SD card and resets the folder and file numbers to "1".

Caution :

- Not available for selection when no SD card is inserted.
- All data on the card will be deleted when it is formatted. Copy all files on the card to a PC before formatting.
- Make sure that the battery pack is fully charged or connect the AC adapter as the formatting process may take some time.

Displaying the Item

- 1 Tap "MENU".

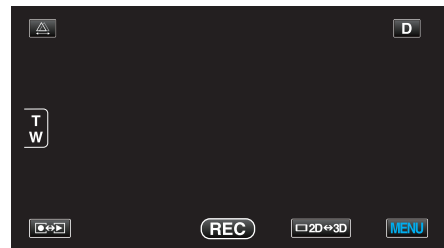

- 2 Tap "⚙️".



- 3 Tap "FORMAT SD CARD".

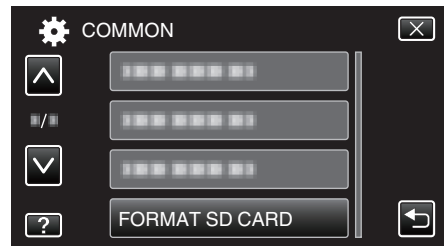

ERASE ALL DATA

Execute this process when disposing of this unit or passing it to another person.

1 Tap "MENU".



2 Tap .



3 Tap "ERASE ALL DATA".



4 Tap "YES".

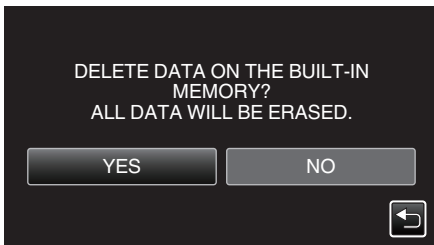

- After deleting is complete, tap "OK".

Caution :

- Connect the AC adapter as it may take some time to delete data.

Memo :

- Repeat the process to make data restoration even more difficult.

Front

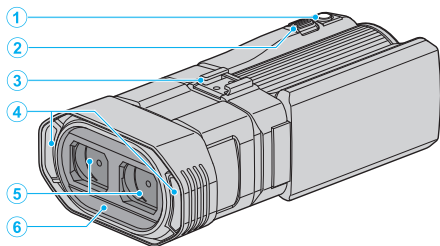

- 1** SNAPSHOT (Still Image Recording) Button
 - Takes a still image.
- 2** Zoom/Volume Lever
 - During shooting: Adjusts the shooting range.
 - During playback (index screen): Moves to the next or previous page.
 - During video playback: Adjusts the volume.
- 3** Shoe
 - Enables an optional external microphone to be attached.
 - “Attaching an External Microphone” (p. 24)
- 4** Stereo Microphone
 - Do not cover the microphone with your fingers during video recording.
- 5** Lens Cover
 - Do not touch the lens.
 - Do not cover the lens with your fingers during recording.
- 6** Remote Sensor

Rear

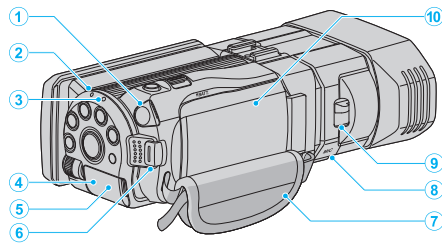

- 1** Headphones Connector
 - Connects to optional headphones.
 - “Attaching Headphones” (p. 23)
- 2** ACCESS (Access) Lamp
 - Lights up/blinks during recording or playback.
 - Do not remove the battery pack, AC adapter, or SD card.
- 3** POWER/CHARGE (Power/Charge) Lamp
 - Lights up: Power “ON”
 - Blinks: Charging in progress
 - Goes out: Charging finished
- 4** HDMI Connector
 - Connects to an HDMI TV.
- 5** DC Connector
 - Connects to an AC adapter to charge the battery.
- 6** START/STOP (Video Recording) Button
 - Starts/stops video recording.
- 7** Grip Belt
 - Pass your hand through the grip belt to hold this unit firmly.
 - “Grip Adjustment” (p. 16)
- 8** Microphone Connector
 - Connects to an optional microphone.
 - “Attaching an External Microphone” (p. 24)
- 9** Lens Cover Switch
 - Opens and closes the lens cover.
- 10** Battery Cover
 - “Attach the battery pack.” (p. 15)

Bottom

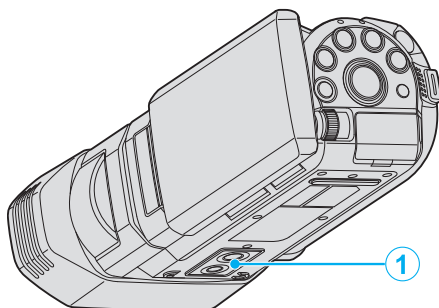

- 1** Tripod Mounting Hole
 “Tripod Mounting” (☞ p. 22)

Interior

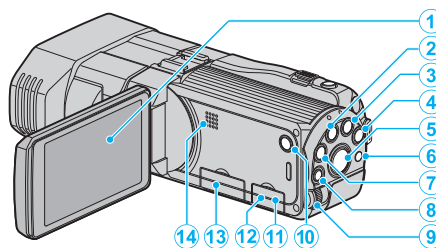

- 1** LCD Monitor
- Turns the power on/off by opening and closing.
 - Enables self-portraits to be taken by rotating the monitor.
- 2** USER Button
 “Setting the USER Button” (☞ p. 43)
- 3** (Video/Still Image) Button
- Switches between video and still image modes.
- 4** i.AUTO Button
- Switches between Intelligent Auto and Manual modes.
- 5** 3D Button
- Switches between 3D and 2D modes.
 - Press and hold until the LED of the button lights up/goes out.
- 6** Remote Sensor
- 7** INFO (Information) Button
- Recording: Displays the remaining time (for video only) and battery power.
 - Playback: Displays file information such as recording date.
- 8** ADJ (Adjustment) Button
- Enables adjustment of “FOCUS”, “BRIGHTNESS ADJUST”, etc.
- 9** Control Dial
 “Using the Control Dial for Recording” (☞ p. 44)
- 10** (Power) Button
- Press and hold to turn the power on/off while the LCD monitor is opened.
- 11** AV Connector
- Connects to a TV, etc.
- 12** USB Connector
- Connects to computer using a USB cable.
- 13** SD Card Slot
- Insert an optional SD card.
- “Inserting an SD Card” (☞ p. 16)
- 14** Speaker
- Outputs audio sound during video playback.

Common Recording Indications

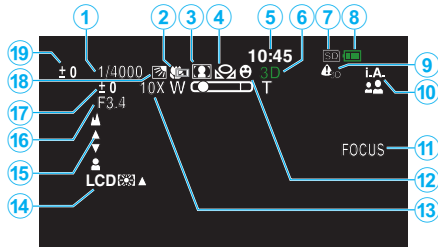

- 1** Shutter Speed
"Setting Shutter Speed" (☞ p. 40)
- 2** Tele Macro (2D mode only)
"Taking Close-up Shots" (☞ p. 42)
- 3** Scene Select
"Scene Selection" (☞ p. 37)
- 4** White Balance
"Setting White Balance" (☞ p. 41)
- 5** Date/Time
"Clock Setting" (☞ p. 19)
- 6** 3D/2D Mode
"3D Button" (☞ p. 137)
- 7** Media
"REC MEDIA FOR VIDEO" (☞ p. 125)
"REC MEDIA FOR IMAGE" (☞ p. 126)
- 8** Battery Indicator
"Remaining Recording Time/Battery Power" (☞ p. 50)
- 9** 3D DISPLAY WARNING (3D mode only)
"3D DISPLAY WARNING (3D mode only)" (☞ p. 130)
- 10** Recording Mode
"Taking Videos in Intelligent Auto Mode" (☞ p. 30)
"Manual Recording" (☞ p. 36)
- 11** Focus Assist
"Using Focus Assist" (☞ p. 39)
- 12** Touch Priority AE/AF
"Capturing Subjects Clearly (TOUCH PRIORITY AE/AF)" (☞ p. 45)
- 13** Zoom
"ZOOM (2D mode only)" (☞ p. 109)
- 14** Monitor Backlight
"MONITOR BRIGHTNESS" (☞ p. 125)
- 15** Focus
"Adjusting Focus Manually" (☞ p. 38)
- 16** APERTURE PRIORITY
"Setting Aperture" (☞ p. 40)
- 17** Brightness
"Adjusting Brightness" (☞ p. 39)
- 18** Backlight Compensation
"Setting Backlight Compensation" (☞ p. 42)
- 19** Parallax Adjustment (3D mode only)
"Adjusting Parallax During Recording" (☞ p. 35)

Video Recording

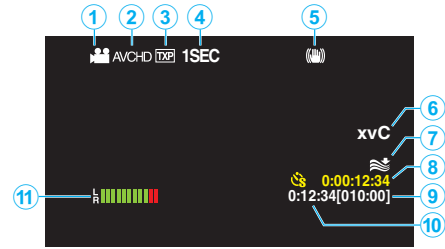

- 1** Video Mode
"Video/Still Image Button" (☞ p. 137)
- 2** 3D VIDEO REC FORMAT
"3D VIDEO REC FORMAT (3D mode only)" (☞ p. 107)
- 3** Video Quality
"VIDEO QUALITY" (☞ p. 108)
- 4** Time-Lapse Recording
"Recording at Intervals (TIME-LAPSE RECORDING)" (☞ p. 47)
- 5** Digital Image Stabilizer
"Reducing Camera Shake" (☞ p. 45)
- 6** x.v.Color (2D mode only)
"x.v.Color (2D mode only)" (☞ p. 110)
- 7** Wind Cut
"WIND CUT" (☞ p. 106)
- 8** Time-Lapse Recording Counter
"Recording at Intervals (TIME-LAPSE RECORDING)" (☞ p. 47)
- 9** Remaining Recording Time
"Remaining Recording Time/Battery Power" (☞ p. 50)
- 10** Scene Counter
- 11** MIC LEVEL
"MIC LEVEL" (☞ p. 111)

Still Image Recording

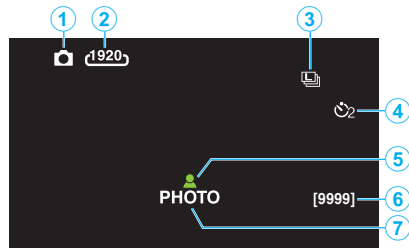

- 1 Still Image Mode
“ / (Video/Still Image) Button” (☞ p. 137)
- 2 Image Size
“IMAGE SIZE” (☞ p. 118)
- 3 Continuous Shooting
“SHUTTER MODE” (☞ p. 117)
“CONT. SHOOTING SPEED” (☞ p. 117)
- 4 Self-Timer
“Taking Group Shots (Self-timer)” (☞ p. 49)
- 5 Focus
“Taking Still Images in Intelligent Auto Mode” (☞ p. 33)
- 6 Remaining Number of Shots
- 7 Recording in Progress

Video Playback

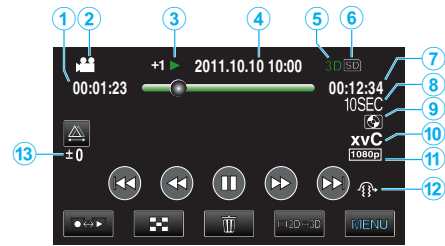

- 1 Scene Counter
- 2 Video Mode
“ / (Video/Still Image) Button” (☞ p. 137)
- 3 Operation Indicator
“Playing Back Videos” (☞ p. 54)
- 4 Date/Time
“Clock Setting” (☞ p. 19)
- 5 3D/2D Mode
“3D Button” (☞ p. 137)
- 6 Media
“REC MEDIA FOR VIDEO” (☞ p. 125)
- 7 Playback Time
“Playing Back Videos” (☞ p. 53)
- 8 Time-Lapse Playback
 - Displays the recording interval of time-lapse recording with an icon.
 “Time-Lapse Setting” (☞ p. 48)
- 9 External Storage Playback
 - “Playing Back with a DVD Writer” (☞ p. 79)
 - “Playing Back with an External Blu-ray Drive” (☞ p. 84)
 - “Playing Back Files in the USB External Hard Disk Drive” (☞ p. 88)
- 10 x.v.Color (2D mode only)
“x.v.Color (2D mode only)” (☞ p. 110)
- 11 Output with 1080p
“HDMI OUTPUT” (☞ p. 131)
- 12 3D MOTION RELIEF (3D mode only)
“3D MOTION RELIEF (3D mode only)” (☞ p. 120)
- 13 Parallax Adjustment (3D mode only)
“Adjusting Parallax During Playback” (☞ p. 57)

Still Image Playback



- 1** Still Image Mode
“ / (Video/Still Image) Button” (☞ p. 137)
- 2** Operation Indicator
“Playing Back Still Images” (☞ p. 56)
- 3** Folder Number
- 4** File Number
- 5** Date/Time
“Clock Setting” (☞ p. 19)
- 6** 3D/2D Mode
“3D Button” (☞ p. 137)
- 7** Media
“REC MEDIA FOR IMAGE” (☞ p. 126)
- 8** External Storage Playback
“Playing Back with a DVD Writer” (☞ p. 79)
“Playing Back with an External Blu-ray Drive” (☞ p. 84)
“Playing Back Files in the USB External Hard Disk Drive” (☞ p. 88)
- 9** Output with 1080p
“HDMI OUTPUT” (☞ p. 131)
- 10** Parallax Adjustment (3D mode only)
“Adjusting Parallax During Playback” (☞ p. 57)

Battery Pack

Unable to turn on the power when using the battery pack.

Recharge the battery pack.

“Charging the Battery Pack” (p. 15)

If the terminal of this unit or the battery pack is dirty, wipe it with a cotton swab or something similar.

If you use any other battery packs besides JVC battery packs, safety and performance cannot be guaranteed. Be sure to use JVC battery packs.

Short usage time even after charging.

Battery deterioration occurs when a battery pack is charged repeatedly.

Replace the battery pack with a new one.

“Optional Accessories” (p. 26)

Unable to charge the battery pack.

When the battery pack is fully charged, the lamp does not flash.

If the terminal of this unit or the battery pack is dirty, wipe it with a cotton swab or something similar.

Using a non-original battery pack may result in damage to this unit. Be sure to use an original battery pack.

The remaining battery display is not correct.

Remaining battery power is not displayed when the AC adapter is connected.

If this unit is used for long periods of time in high or low temperatures, or if the battery pack is repeatedly charged, the amount of remaining battery may not be displayed correctly.

The battery depletes even when the AC adapter is connected.

Please use a JVC AC adapter (AP-V20M).

Recording

Recording cannot be performed.

Check the  button.

“Interior” (p. 137)

Set to the recording mode with the  button.

“Names of Buttons and Functions on the LCD Monitor” (p. 18)

Recording stops automatically.

Recording stops automatically as it cannot be performed for 12 or more consecutive hours according to specifications. (It may take some time to resume recording.)

Turn off this unit, wait for a while, and turn it on again. (This unit stops automatically to protect the circuit when the temperature rises.)

The continuous shooting speed of still images is slow.

The continuous shooting speed will drop if this function is used repeatedly. Continuous shooting speed may drop depending on the SD card or under certain recording conditions.

The focus is not adjusted automatically.

If you are recording in a dark place or a subject that has no contrast between dark and light, adjust the focus manually.

“Adjusting Focus Manually” (p. 38)

Wipe the lens with a lens cleaning cloth.

Cancel manual focus on the manual recording menu.

“Adjusting Focus Manually” (p. 38)

Zoom does not work.

Digital zoom is not available in the still image recording mode.

Zoom operation is not available in time-lapse recording. (Simultaneous still image recording and image stabilizer are also not available.)

To use digital zoom, set “ZOOM” in the menu to “40x/DIGITAL” or “200x/DIGITAL”.

“ZOOM (2D mode only)” (p. 109)

Mosaic-type noise occurs when recording scenes with fast movements or extreme changes in brightness.

Set “VIDEO QUALITY” to “THR” or “TXP” during 3D mode or “UXP” or “XP” during 2D mode for recording.

“VIDEO QUALITY” (p. 108)

Vertical lines appear on recorded images.

Such a phenomenon occurs when shooting a subject illuminated by bright light. This is not a malfunction.

Card

Cannot insert the SD card.

Make sure not to insert the card in the wrong direction.
“Inserting an SD Card” (☞ p. 16)

Unable to copy to SD card.

To record to the card, it is necessary to perform media settings.
“REC MEDIA FOR VIDEO” (☞ p. 125)
To use cards that have been used on other devices, it is necessary to format (initialize) the card using “FORMAT SD CARD” from media settings.
“FORMAT SD CARD” (☞ p. 134)

Playback

Sound or video is interrupted.

Sometimes playback is interrupted at the connecting section between two scenes. This is not a malfunction.

The same image is displayed for a long time.

Clean the terminals of the SD card with a dry cotton swab or something similar.
Execute “FORMAT SD CARD” in the “COMMON” menu. (All data will be deleted.)
“FORMAT SD CARD” (☞ p. 134)

The motion is choppy.

When “3D MOTION RELIEF” is set to “ON” during playback, scenes that are likely to cause motion sickness will be skipped. To play back normally even for the scenes that are likely to cause motion sickness, set “3D MOTION RELIEF” to “OFF”.
“3D MOTION RELIEF (3D mode only)” (☞ p. 120)
To avoid recording scenes that will be played back in stop-motion, refer to “Precautions on Recording and Playing Back 3D Images”.
“Precautions on Recording and Playing Back 3D Images” (☞ p. 11)
Replace the SD card. (When the SD card is damaged, difficulty in reading the data occurs. This unit will try to play back as much as possible, but it will stop eventually if the condition persists.)
Execute “FORMAT SD CARD” in the “COMMON” menu. (All data will be deleted.)
“FORMAT SD CARD” (☞ p. 134)
Verify the system requirements of your PC when using Everio MediaBrowser 3D to play back.
“Verifying System Requirements (Guideline)” (☞ p. 95)

Cannot find a recorded file.

Press the 3D button to switch to the desired mode for playback.
“Playing Back Videos” (☞ p. 53)
Set “3D VIDEO REC FORMAT” in the video recording menu to “AVCHD” or “MP4(MVC)”.
* For customers who completed the firmware update
Set “3D VIDEO REC FORMAT” in the video recording menu to “AVCHD 3D”, “AVCHD”, or “MP4(MVC)”.
“3D VIDEO REC FORMAT (3D mode only)” (☞ p. 107)
Change the playback media by tapping  on the index screen.
“Operation Buttons for Video Playback” (☞ p. 54)
“Operation Buttons for Still Image Playback” (☞ p. 56)
Select “PLAYBACK OTHER FILE” in the menu. (Video files that have damaged management information can be played back.)
“Playing a Video with Defective Management Information” (☞ p. 55)

No date/time display.

Recording date and time will not be displayed when playing back a disc that contains videos recorded in 3D mode.
When playing back a disc created in DVD-Video format, no information such as date and time will be displayed.

Images do not appear on the TV properly.

Disconnect the cable and connect again.
“Connecting via the HDMI Mini Connector” (☞ p. 62)
Turn off and on this unit again.

Images are projected vertically on the TV.

Set “VIDEO OUTPUT” in the “COMMON” menu to “4:3”.
“VIDEO OUTPUT (2D mode only)” (☞ p. 130)
Adjust the TV’s screen accordingly.

The image displayed on TV is too small.

Set “VIDEO OUTPUT” in the “COMMON” menu to “16:9”.
“VIDEO OUTPUT (2D mode only)” (☞ p. 130)

Unable to delete file.

Files (videos/still images) that are protected cannot be deleted. Release protection before deleting the file.
“Protecting Files” (☞ p. 68)

When connected to the TV via the HDMI mini cable, proper images and sounds are not output.

Images and sounds may not be output properly depending on the TV connected. In such cases, perform the following operations.
① Disconnect the HDMI mini cable and connect it again.
② Turn off and on this unit again.
“Connecting via the HDMI Mini Connector” (☞ p. 62)

3D images cannot be seen on a 3D compatible TV properly.

Set “HDMI OUTPUT” in the “COMMON” menu accordingly.
“HDMI OUTPUT” (☞ p. 131)

Editing/Copying

Unable to delete file.

Files (videos/still images) that are protected cannot be deleted. Release protection before deleting the file.
“Protecting Files” (☞ p. 68)

Unable to copy/move files to SD card.

If the SD card is write protected, set it to off.

BACK-UP menu does not disappear.

While the USB cable is connected, the “BACK-UP” menu is displayed.

Unable to turn off the BACK-UP menu.

Turn off the power of this unit and the DVD writer, or remove the AC adapter.

Computer

Unable to copy files to DVD or Blu-ray disc with a PC.

To record to discs, a recordable DVD or Blu-ray drive is required for the computer in use.

Screen/Image

The LCD monitor is difficult to see.

The LCD monitor may be difficult to see if used in bright areas such as under direct sunlight.

The LCD monitor appears darker when 3D images are displayed. Change the display to 2D when it is difficult to see, such as when using this unit outdoors.

A band or a ball of bright light appears on the LCD monitor.

Change the direction of this unit to prevent the light source from coming into view. (A band or a ball of bright light may appear when there is a bright light source near this unit, but this is not a malfunction.)

The recorded subject is too dark.

Use backlight compensation when the background is bright and the subject is dark.

“Setting Backlight Compensation” (☞ p. 42)

Use “NIGHTALIVE” in SCENE SELECT.

“Scene Selection” (☞ p. 37)

Use “GAIN UP” in the menu.

“GAIN UP” (☞ p. 106)

Set “BRIGHTNESS ADJUST” in the recording menu to the “+” side.

“Adjusting Brightness” (☞ p. 39)

The recorded subject is too bright.

Set the backlight compensation to “OFF” if it is being used.

“Setting Backlight Compensation” (☞ p. 42)

Set “BRIGHTNESS ADJUST” in the recording menu to the “-” side.

“Adjusting Brightness” (☞ p. 39)

The color looks strange. (Too bluish, too reddish, etc.)

Wait for a while until natural colors are achieved. (It may take some time for white balance to be adjusted.)

Set “WHITE BALANCE” in the recording menu to “MANUAL”. Select from

“FINE”/“CLOUD”/“HALOGEN” according to the light source.

Select “MWB” and adjust accordingly.

“Setting White Balance” (☞ p. 41)

The color looks different.

Set “WHITE BALANCE” in the recording menu to “MANUAL”. Select from

“FINE”/“CLOUD”/“HALOGEN” according to the light source.

Select “MWB” and adjust accordingly.

“Setting White Balance” (☞ p. 41)

When the video was recorded with “x.v.Color” set to “ON”, change the setting as desired on TV.

“x.v.Color (2D mode only)” (☞ p. 110)

Other Problems

The buttons on the touch screen do not work.

Tap the buttons on the touch screen with your fingers.

The buttons may not respond if you touch them with your fingernails or with gloves on.

The unit operates slowly when switching between video mode and still image mode, or when switching the power on or off.

It is recommended that you copy all videos and still images onto your computer, and erase the files from this unit. (If there are many recorded files on this unit, it takes time for the unit to respond.)

The image is grainy.

When digital zoom is used, the image becomes grainy as it is digitally enlarged.

This unit heats up.

This is not a malfunction. (This unit may become warm when used for a long time.)

Make a backup of important recorded data.

It is recommended to copy your important recorded data to a DVD or other recording media for storage.

JVC will not be responsible for any lost data.

When connected to the TV via the HDMI mini cable, proper images and sounds are not output.

Images and sounds may not be output properly depending on the TV connected. In such cases, perform the following operations.

① Disconnect the HDMI mini cable and connect it again.

② Turn off and on this unit again.

“Connecting via the HDMI Mini Connector” (☞ p. 62)

The language on the display changed.

It may occur when you connect this unit to a TV with different language setting using an HDMI mini cable.

“Operating in Conjunction with TV via HDMI” (☞ p. 61)

HDMI-CEC functions do not work properly, and the TV does not work in conjunction with this unit.

TVs may operate differently depending on the specifications, even if they are HDMI-CEC compliant. Therefore, the HDMI-CEC functions of this unit cannot be guaranteed to operate in combination with all the TVs. In such cases, set “HDMI CONTROL” to “OFF”.

“Operating in Conjunction with TV via HDMI” (☞ p. 61)

Error Message?

CHECK LENS COVER

Open the lens cover.

SET DATE/TIME!

Connect the AC adapter, charge the battery for more than 24 hours and set the clock. (If the message still appears, the clock battery is exhausted.

Consult your nearest JVC dealer.)

“Clock Setting” (☞ p. 19)

COMMUNICATION ERROR

Reconnect the USB cable.

Turn off this unit and the devices connected to it, and turn them on again.

Reattach the battery pack.

FORMAT ERROR!

Check the operating procedure, and perform once again.

“FORMAT BUILT-IN MEM.” (☞ p. 134)

Turn off and on this unit again.

DATA DELETION ERROR

Check the operating procedure, and perform once again.

“ERASE ALL DATA” (☞ p. 135)

Turn off and on this unit again.

ERROR IN BUILT-IN MEMORY!

Turn off and on this unit again.

If the above does not solve the problem, back up your files and execute “FORMAT BUILT-IN MEM.” in the “COMMON” menu. (All data will be deleted.)

“FORMAT BUILT-IN MEM.” (☞ p. 134)

MEMORY CARD ERROR!

Turn off and on this unit again.

Remove the AC adapter and battery pack, then remove and re-insert the SD card.

Remove any dirt from the SD card terminals.

If the above does not solve the problem, back up your files and execute “FORMAT SD CARD” in the “COMMON” menu. (All data will be deleted.)

“FORMAT SD CARD” (☞ p. 134)

NOT FORMATTED

Select “OK”, then select “YES” on the “DO YOU WANT TO FORMAT?” screen.

RECORDING FAILURE

Turn off and on this unit again.

PLAYBACK FAILED

Remove and re-insert the SD card.

“Inserting an SD Card” (☞ p. 16)

Remove any dirt from the SD card terminals.

Insert the SD card before turning on the power.

Do not subject this unit to any strong impact or vibration.

VIDEO MANAGEMENT FILE IS DAMAGED, RECOVERY IS REQUIRED TO RECORD/PLAYBACK, RECOVER?

Select “OK” to restore. (Videos that cannot be restored will not be displayed on the index screen, but you may be able to play them back using “PLAYBACK OTHER FILE” in the menu.)

“Playing a Video with Defective Management Information” (☞ p. 55)

UNSUPPORTED FILE!

Use files recorded with this unit. (Files recorded with other devices may not be playable.)

THIS FILE IS PROTECTED

Switch off the “PROTECT/CANCEL” function in the “EDIT” menu.

“Protecting Files” (☞ p. 68)

CHECK CARD'S WRITE PROTECTION SWITCH

Set the write protect switch of the SD card to off.

INSUFFICIENT AVAILABLE SPACE

Delete files, or move files to a PC or other devices.

Replace the SD card with a new one.

SCENE QUANTITY EXCEEDED LIMIT

① Move the files or folders to a PC or other device. (Back up your files.)

② Select “FILE + MANAGEMENT NO” in “FORMAT BUILT-IN MEM.” or “FORMAT SD CARD” of the “COMMON” menu. (All data on the built-in memory or SD card will be deleted.)

NUMBER OF FOLDERS OVERFLOW

① Move the files or folders to a PC or other device. (Back up your files.)

② Select “FILE + MANAGEMENT NO” in “FORMAT BUILT-IN MEM.” or “FORMAT SD CARD” of the “COMMON” menu. (All data on the built-in memory or SD card will be deleted.)

FILE QUANTITY LIMIT EXCEEDED

① Move the files or folders to a PC or other device. (Back up your files.)

② Select “FILE + MANAGEMENT NO” in “FORMAT BUILT-IN MEM.” or “FORMAT SD CARD” of the “COMMON” menu. (All data on the built-in memory or SD card will be deleted.)

CAMERA TEMPERATURE IS TOO COLD KEEP CAMERA POWER ON PLEASE WAIT

Leave this unit turned on for a while.

If the warning still does not disappear, turn off the power and move the unit to a warm place while taking care to avoid a sudden temperature change.

Turn on the power again after a while.

RECORDING CANCELLED

Set “REC MEDIA FOR VIDEO” to “SD”, then record to an SD card.

“REC MEDIA FOR VIDEO” (☞ p. 125)

Turn off and on this unit again.

Protect the unit from vibration and shock.

UNABLE TO RECORD PROPERLY IN 3D PLEASE SWITCH TO 2D FOR RECORDING

Consult your JVC dealer or the JVC service center.

TOO MUCH PARALLAX BETWEEN LEFT & RIGHT IMAGES. YOU MAY NOT BE ABLE TO VIEW THE 3D IMAGES

Check the shooting distance during 3D recording such that recording is performed within the optimal zone.

“Precautions on Recording and Playing Back 3D Images” (☞ p. 11)

Maintenance

Perform regular maintenance of this unit to enable it to be used for a long time.

Caution :

- Be sure to detach the battery pack, AC adapter, and power plug before performing any maintenance.

Camcorder

- Wipe this unit with a dry, soft cloth to remove any dirt.
- When it is extremely dirty, soak the cloth in a solution of neutral detergent, wipe the body with it, and then use a clean cloth to remove the detergent.

Caution :

- Do not use benzene or thinner. Doing so may cause damage to the unit.
- When using a chemical cloth or cleaner, be sure to observe the warning labels and instructions of the product.
- Do not leave the device in contact with rubber or plastic products for a long time.

Lens/LCD Monitor

- Use a lens blower (commercially available) to remove any dust, and a cleaning cloth (commercially available) to wipe off any dirt.
Mold may form if the lens is left dirty.

Camera

Item	Details
Power supply	Using AC adapter: DC 11 V Using BN-VF815U battery pack: DC 7.2 V
Power consumption	<ul style="list-style-type: none"> 3D Mode (AVCHD) 4.8 W (when display on LCD monitor is set to "3D" and "MONITOR BRIGHTNESS" is set to "STANDARD"), Rated Current Consumption: 1.0 A 4.5 W (when display on LCD monitor is set to "2D" and "MONITOR BRIGHTNESS" is set to "STANDARD"), Rated Current Consumption: 1.0 A 3D Mode (MP4(MVC)) 5.5 W (when display on LCD monitor is set to "3D" and "MONITOR BRIGHTNESS" is set to "STANDARD"), Rated Current Consumption: 1.0 A 5.2 W (when display on LCD monitor is set to "2D" and "MONITOR BRIGHTNESS" is set to "STANDARD"), Rated Current Consumption: 1.0 A 2D Mode 3.8 W (when "MONITOR BRIGHTNESS" is set to "STANDARD"), Rated Current Consumption: 1.0 A <p>■ For customers who completed the firmware update</p> <ul style="list-style-type: none"> 3D Mode (AVCHD 3D) 5.4 W (when display on LCD monitor is set to "3D" and "MONITOR BRIGHTNESS" is set to "STANDARD"), Rated Current Consumption: 1.0 A 5.2 W (when display on LCD monitor is set to "2D" and "MONITOR BRIGHTNESS" is set to "STANDARD"), Rated Current Consumption: 1.0 A
Dimensions (mm)	102 x 64 x 186 (W x H x D: excluding grip belt)
Mass	Approx. 590 g (camera only), Approx. 675 g (including supplied battery pack)
Operating environment	Allowable operating temperature: 0°C to 40°C Allowable storage temperature: -20°C to 50°C Allowable relative humidity: 35 % to 80 %
Image pickup device	1/4.1" 3,320,000 pixels (progressive CMOS) x2
Recording area (Video)	<ul style="list-style-type: none"> 3D Mode 2,360,000 pixels (when "DIS" is set to "OFF") 2,070,000 pixels (when "DIS" is set to "ON") 1,820,000 pixels (when "DIS" is set to "ON (AIS)") 2D Mode 2,980,000 pixels (when "DIS" is set to "OFF") 2,070,000 to 2,980,000 pixels (when "DIS" is set to "ON") 2,070,000 to 2,360,000 pixels (when "DIS" is set to "ON (AIS)")
Recording area (Still image)	<ul style="list-style-type: none"> 3D Mode 2,070,000 pixels (16:9) 2D Mode 2,980,000 pixels (16:9) 2,240,000 pixels (4:3)
Lens	<ul style="list-style-type: none"> 3D Mode F1.2 - 2.28, f= 3.76 mm to 18.8 mm 35 mm conversion: 44.8 mm to 224 mm (when "DIS" is set to "ON") 35 mm conversion: 42 mm to 210 mm (when "DIS" is set to "OFF") 2D Mode F1.2 - 2.8, f= 3.76 mm to 37.6 mm 35 mm conversion: 37.3 mm to 373 mm (when "DIS" is set to "ON")

	35 mm conversion: 37.3 mm to 373 mm (when "DIS" is set to "OFF") 35 mm conversion: 42.0 mm to 420 mm (when "DIS" is set to "ON (AIS)")
Lowest illumination	8 lux ("GAIN UP": "ON") 4 lux ("GAIN UP": AUTO SLOW-SHUTTER) 1 lux ("SCENE SELECT": "NIGHTALIVE" mode)
Zoom (during video recording)	Optical zoom: Up to 5x (during 3D recording), Up to 10x (during 2D recording) Digital zoom: 11 - 200x (during 2D recording)
Zoom (during still image recording)	Optical zoom: Up to 5x (during 3D recording), Up to 10x (during 2D recording)
Continuous shooting speed (during still image recording)	<ul style="list-style-type: none"> 3D Mode HIGH SPEED: Approx. 12 images/second (Up to 12 images) LOW SPEED: Approx. 1.4 images/second (Maximum) 2D Mode HIGH SPEED: Approx. 12 images/second (Up to 40 images) LOW SPEED: Approx. 1.4 images/second (Maximum)
LCD monitor	3.5", 92.16 megapixels, polysilicon color LCD
Recording media	Built-in memory (64 GB), SD/SDHC/SDXC card (commercially available) "Types of Usable SD Card" (p. 17)
Clock battery	Rechargeable battery

Connectors

Item	Details
HDMI output	HDMI Mini Connector (x.v.Color compatible)
AV output connector	Video output: 1.0 V (p-p), 75 Ω Audio output: 300 mV (rms), 1 KΩ
USB connector	Mini USB Type AB, USB 2.0 compliant
Headphones output	Φ3.5 mm minijack: Stereo, Analog output
Microphone input	Φ3.5 mm minijack: Stereo, Analog output, Plug-in power compliant

Video

■ **3D Mode (AVCHD)**

Item	Details
Recording/ Playback format	AVCHD standard Video: MPEG-4 AVC/H.264 Audio: Dolby Digital 2ch
Extension	.MTS
Signal system	Digital high definition system (1080/50i x 2) PAL standard
Image quality (Video)	TXP 1920 x 1080 pixels Average Approximate 17 Mbps TSP 1920 x 1080 pixels Average Approximate 12 Mbps
Sound quality (Audio)	48 kHz, 256 kbps

■ **3D Mode (MP4(MVC))**

Item	Details
Recording/ Playback format	MP4 standard Video: MPEG-4 MVC (original format) /H.264 Audio: AAC 2ch
Extension	.MP4
Signal system	Digital high definition system (1080/50i x 2) PAL standard
Image quality (Video)	THR 1920 x 1080 pixels Average Approximate 34 Mbps TSR 1920 x 1080 pixels Average Approximate 22 Mbps
Sound quality (Audio)	48 kHz, 192 kbps (Max 192 kbps, Average 128 kbps)

■ **2D Mode**

Item	Details
Recording/ Playback format	AVCHD standard Video: MPEG-4 AVC/H.264 Audio: Dolby Digital 2ch
Extension	.MTS
Signal system	Digital high definition system (1080/50i) PAL standard
Image quality (Video)	UXP 1920 x 1080 pixels Average Approximate 24 Mbps XP 1920 x 1080 pixels Average Approximate 17 Mbps SP 1920 x 1080 pixels Average Approximate 12 Mbps EP 1920 x 1080 pixels Average Approximate 5 Mbps
Sound quality (Audio)	48 kHz, 256 kbps

For customers who completed the firmware update

■ **3D Mode (AVCHD 3D)**

Item	Details
Recording/ Playback format	AVCHD Standard Ver. 2.0 compliant Video: MPEG-4 MVC/H.264 Audio: Dolby Digital 2ch
Extension	.MTS
Signal system	Digital high definition system (1080/50i x 2) PAL standard
Image quality (Video)	1920 x 1080 pixels Up to Approximate 28 Mbps
Sound quality (Audio)	48 kHz, 256 kbps

Still Image

■ 3D Mode

Item	Details
Recording format	MPF(compatible with Disparity)
Extension	.MPO
Image size	“Approximate Number of Still Images (Unit: Number of Shots)” (☞ p. 51)

■ 2D Mode

Item	Details
Recording format	JPEG standard
Extension	.JPG
Image size	“Approximate Number of Still Images (Unit: Number of Shots)” (☞ p. 51)
Quality	FINE

AC Adapter (AP-V20M)

Item	Details
Power supply	AC 110 V to 240 V, 50 Hz/60 Hz
Output	DC 11 V, 1.0 A
Allowable operating temperature	0°C to 40°C (10°C to 35°C during charging)
Dimensions (mm)	50 x 29 x 100 (W x H x D: excluding cord and AC plug)
Mass	Approx. 105 g

Battery Pack (BN-VF815U)

Item	Details
Power voltage	7.2 V
Capacity	1460 mAh
Dimensions (mm)	30.5 x 32.5 x 52 (W x H x D)
Mass	Approx. 85 g

Remote Control (RM-V760U)

Item	Details
Power supply	DC 3 V (button battery CR2025)
Battery life	Approx. 1 year (depending on frequency of use)
Operating distance	Approx. 5 m (facing up)
Allowable operating temperature	0°C to 40°C
Dimensions (mm)	32.5 x 15.6 x 68 (W x H x D)
Mass	Approx. 16 g (including battery pack)

“Optional Accessories” (☞ p. 26)

Memo : _____

- The specifications and appearance of this product are subject to changes for further improvement without prior notice.

JVC