

JVC

CAMCORDER

Detailed User Guide

GZ-RX110/GZ-RX120



Table of Contents

Getting Started

Verifying the Accessories	4
Turning on this Unit	5
Opening the Terminal Cover (SD Card Cover)	6
Charging	6
Resetting this Unit	7
Quad Proof	7
Before Using Underwater or under Low Temperature	8
Grip Adjustment	9
Attaching the Core Filter	10
Inserting an SD Card	10
Types of Usable SD Card	11
Using the Touch Screen	12
Locking the Screen (when Shooting Underwater)	12
Adjusting the Touch Panel	12
Names of Buttons and Functions on the LCD Monitor	13
Clock Setting	16
Resetting the Clock	17
Changing the Display Language	18
Holding this Unit	18
Tripod Mounting	19
Using this Unit Overseas	19
Charging the Battery Pack Overseas	19
Setting the Clock to Local Time when Traveling	20
Setting Daylight Saving Time	20
Optional Accessories	21

Recording

Taking Videos in Auto Mode	22
Capturing Still Images During Video Recording	24
Taking Still Images in Auto Mode	25
Zooming	27
Manual Recording	28
Adjusting Focus Manually (FOCUS)	29
Adjusting Brightness	30
Setting Backlight Compensation	31
Setting White Balance	32
Taking Close-up Shots (TELE MACRO)	33
Shooting under Water	34
Recording with Effects	36
Recording Images Like an Old Black and White Photo (GRAINY MONOCHROME)	36
Recording Food Images (FOOD)	37
Recording Images of a Baby (BABY)	38
Recording with Animation Effects (ANIMATION EFFECT)	39
Capturing Subjects Clearly (TOUCH PRIORITY AE/AF)	42
Reducing Camera Shake	43
Recording at Intervals (TIME-LAPSE RECORDING)	44
Taking Group Shots (Self-timer)	45
Recording Videos with Date and Time	46
Checking the Remaining Recording Time	47

Playback

Playing Back Videos	49
Normal Playback	50
Checking the Recording Date and Other Information	52
DIGEST PLAYBACK	53
PLAYBACK PLAYLIST	54
PLAYBACK OTHER FILE	55
Playing Back Still Images	56
Slideshow Playback	57
Connecting to and Viewing on TV	58
Connecting via the HDMI Mini Connector	58
Connecting via the AV Connector	60

Editing

Deleting Unwanted Files	61
-------------------------------	----

Deleting the Currently Displayed File	61
Deleting Selected Files	61
Protecting Files	62
Protecting/Releasing Protection of the Currently Displayed File	62
Protecting/Releasing Protection of Selected Files	63
Capturing a Still Image in the Video During Playback	64
Combining Videos Recorded by Seamless Recording	65
Capturing a Required Part in the Video (TRIMMING)	66
Deleting Playlists	67

Copying

Creating Discs with a BD Writer (External Blu-ray Drive)	68
Preparing a BD Writer (External Blu-ray Drive)	68
Creating a Disc	69
Playing Back with a BD Writer (External Blu-ray Drive)	75
Creating Discs with a DVD Writer	76
Preparing a DVD Writer (CU-VD3)	76
Preparing a DVD Writer (CU-VD50)	77
Creating a Disc	77
Playing Back with a DVD Writer	83
Dubbing Files to a Disc by Connecting to a Blu-ray Recorder	83
Dubbing Files to a Disc by Connecting to a DVD Recorder	84
Dubbing Files to a VHS Tape by Connecting to a VCR	85
Using a USB External Hard Disk Drive	86
Preparing a USB External Hard Disk Drive	87
Copying All Files	87
Playing Back Files in the USB External Hard Disk Drive	88
Deleting Folders in the USB External Hard Disk Drive	89
Formatting the USB External Hard Disk Drive	89
Importing Files from the USB External Hard Disk Drive	90
Copying Files to an SD Card	91
Copying to Windows PC	92
Verifying System Requirements (Guideline)	92
Installing the Provided Software (Built-in)	95
Backing Up All Files	97
Organizing Files	98
Recording Videos to Discs	99
Backing Up Files Without Using Provided Software	101
List of Files and Folders	102
Copying to Mac Computer	103

Using Wi-Fi

Wi-Fi Capabilities	104
Operating Environment	105
Precautions on Using Wi-Fi	105
Image Monitoring via Direct Connection (DIRECT MONITORING)	106
Image Monitoring via an Access Point at Home (INDOOR MONITORING)	109
Recording the Location Information	112
Changing the Settings	115
Registering Access Point Using Wi-Fi Protected Setup (WPS)	116
Registering Access Point Using WPS PIN	117
Checking the MAC Address of this Camera	118
Initializing the Wi-Fi Settings	118
Using Smartphone Applications	119
Indications on the screen	119
Using the Markings	120
Using the Game Score	121
Transferring Videos (AVCHD format)	123
Transferring Still Images	126
Smartphone Application Settings	128
Troubleshooting	130
Wi-Fi Specifications	134

Using Wi-Fi by Creating a QR Code

DIRECT MONITORING	136
INDOOR MONITORING	139

OUTDOOR MONITORING	142
Registering Access Point Manually	146

Settings Menu

Operating the Menu	147
Operating the Top Menu	147
Operating the Shortcut Menu	148
Shortcut Menu (video/still image)	149
RECORD SETTING Menu (video)	150
SPECIAL RECORDING Menu (video)	154
RECORD SETTING Menu (still image)	155
SPECIAL RECORDING Menu (still image)	157
PLAYBACK SETTING Menu (video)	158
EDIT Menu (video)	159
PLAYBACK SETTING Menu (still image)	160
EDIT Menu (still image)	161
SETUP (video/still image)	162
CONNECTION SETTINGS (video/still image)	164
MEDIA SETTINGS (video/still image)	165
USB CONNECTION MENU	166

Names of Parts	167
-----------------------------	------------

Indications on the LCD monitor	170
---	------------

Troubleshooting

When the unit is not working properly	173
Battery Pack	174
Power supply	174
Recording	175
SD Card	175
Playback	176
Editing/Copying	176
Computer	177
Screen/Image	177
Other Problems	178
Error Message?	179







Maintenance	181
--------------------------	------------

Specifications	182
-----------------------------	------------

Trademarks	184
-------------------------	------------

Verifying the Accessories

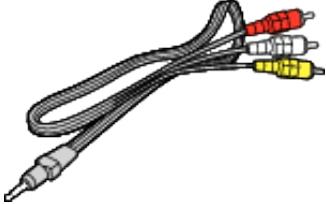
If any of the items are missing or defective, consult your JVC dealer or the nearest JVC service center.

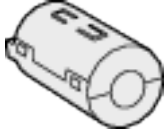
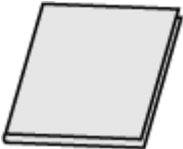
Illustration	Description
	<p>AC Adapter AC-V10M</p> <ul style="list-style-type: none"> Charges this unit. Attach the charging adapter cable to the tip of the cord. It can also be used when recording or playing back videos indoors.
	<p>Charging Adapter Cable</p> <ul style="list-style-type: none"> Attach to the tip of the cord of the AC adapter and connect to the USB connector of this unit to charge.
	<p>Power Cord</p> <ul style="list-style-type: none"> Connect the power cord to the AC adapter.
	<p>USB Cable (Type A - Micro Type B)</p> <ul style="list-style-type: none"> Connects this unit to a computer.
	<p>AV Cable QAM1322-001</p> <ul style="list-style-type: none"> Connects this unit to a TV to play back recorded images on the TV. Please consult your JVC dealer or the nearest JVC service center when purchasing a new AV cable.
	<p>Small Core Filter (for AC Adapter)</p>
	<p>Large Core Filter (for Optional AV Cable)</p>
	<p>Basic User Guide</p> <ul style="list-style-type: none"> Read well and keep in a safe place where it can be accessed easily when necessary.

Memo :

- The provided software (application software) is built into this unit.
- “Verifying System Requirements (Guideline)” (☞ p. 92)
- The large core filter is for use with an optional AV cable. Do not use it with any cable other than the AV cable. The small core filter is for use with the AC adapter. Do not use it with anything other than the AC adapter.
- “Attaching the Core Filter” (☞ p. 10)
- SD cards are sold separately.
- “Types of Usable SD Card” (☞ p. 11)
- When using the AC adapter overseas, please prepare a commercially available converter plug for the country or region of visit.
- “Charging the Battery Pack Overseas” (☞ p. 19)

Turning on this Unit

Open the LCD monitor to turn on this unit.
To turn off the power, close the LCD monitor.

■ To turn on the power

Open the LCD monitor.

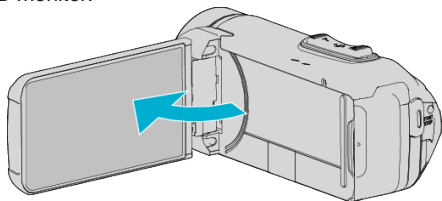

■ To turn off the power

Close the LCD monitor.

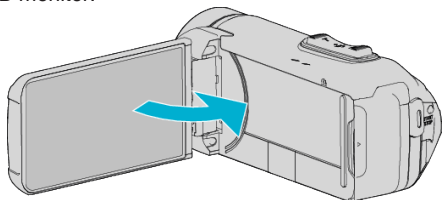

The POWER/ACCESS lamp goes off and the power is turned off.
“POWER/ACCESS (Power/Access) Lamp” (p. 168)

Opening the Terminal Cover (SD Card Cover)

To open

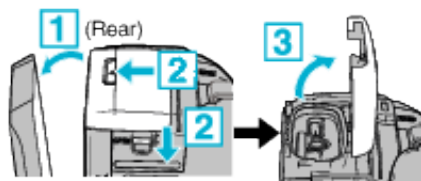

- 1 Open the LCD monitor.
- 2 Slide down the terminal cover lock and slide the cover aside.
- 3 Lift the cover slowly.

To close

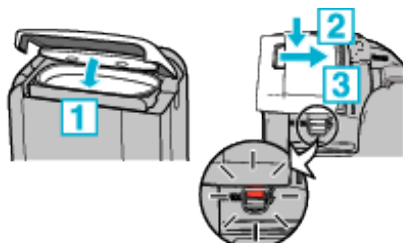

The cover is not properly closed if the red mark at the terminal cover lock is visible.

Leave the LCD monitor open first.

- 1 Flip down the cover slowly while making sure the gray waterproof seal fits into the opening at the terminals.
- 2 Press the entire cover against the camcorder with equal force and firmly attach the cover completely.
- 3 Slide the cover until it clicks into place.

The cover is not properly closed if the red mark on the terminal cover lock is visible.

Caution :

- Ensure that the terminal cover and the gray waterproof seal are not damaged and that there are no foreign materials (such as hair, lint, sand or dust) adhered on the cover.
- Stop using the unit underwater if there are damages to the cover, etc. and consult your JVC dealer or the nearest JVC service center.
- Do not apply excessive force when opening/closing the terminal cover.
- Read the "Cautions on Using Underwater" (p. 8) before using the camera underwater or in places exposed to water droplets.



Charging

This unit is equipped with a built-in battery.

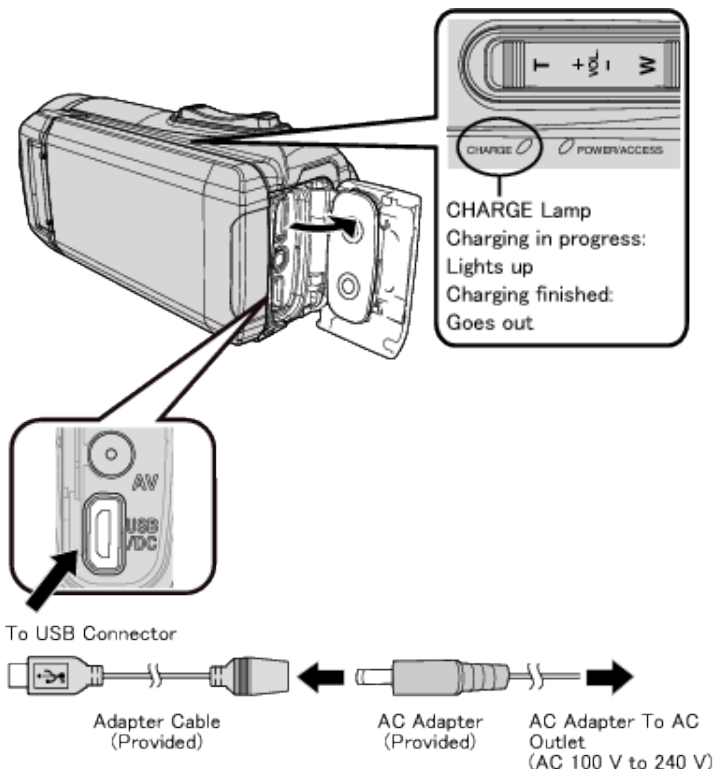
Open the connector cover, and connect the AC adapter for charging as shown in the figure.



Caution :

- The built-in battery is not charged at the time of purchase.
- At the time of purchase or in case of the battery is not used for a long period of time, the charging time will be longer than usual. The camera does not turn on if the remaining battery power is low. In this case, charge the battery for more than 20 minutes before turning on the power.
- Charging time: Approx. 4 h 40 m (when charging at 25 °C)
- The battery cannot be charged outside the room temperature range of 10°C to 35°C. The CHARGE lamp does not light up when the battery is not being charged. If the temperature increases or decreases during charging, the CHARGE lamp will blink slowly and charging will stop. In this case, remove the AC adapter, press the Reset button and wait until the room temperature is within the above stated range before charging again.
- You can record or play back videos during charging. (However, the charging time will be longer than usual. In addition, the remaining battery power may decrease according to conditions.) If the internal temperature rises when using the unit, stop the charging temporarily. (The CHARGE lamp goes off.)
- If malfunctions (such as overvoltage) occur, charging will stop. In these cases, CHARGE lamp blinks quickly as a notification.
- During charging, the  icon on the screen changes to  to indicate that charging is in progress. (when the provided AC adapter is used)
- When the recording time becomes extremely short even when the battery is fully charged, the battery needs to be replaced. For details on replacing the built-in battery (subject to a fee), consult the nearest JVC service center.

Caution :

- There are certain specifications for a USB rechargeable device. To charge, use a device with the output voltage of 5 V/1 A or more.
- Depending on the specification of your charging device and the thickness and length of a USB cable used to connect to this unit, the charging time may be longer than usual, or it may not even start.
- We shall not be held liable for malfunctions that are due to using non-standard device or a device with poor quality.

Resetting this Unit

When a malfunction occurs on this unit, reset the unit in the following way.

- 1 Open the terminal cover.
 - Remove the power cord and all connecting cables.
- 2 Close the LCD monitor to turn off this unit.
- 3 Press the Reset button gently using an object with pointed tip.

Caution :

- Press the Reset button just once gently.
- Do not use sharp pointed objects. It may damage the unit or cause electric shock.





Memo :

- If malfunction persists even after pressing the Reset button, refer to "Troubleshooting" (☞ p. 172) .

Quad Proof

This unit is equipped with Waterproof, Dust-proof, Drop-proof and Freeze-proof features.

QUAD PROOF

	Waterproof: Equivalent to IEC Standard publication 529 IPX8 (30 minutes at depths up to 5 m)		Dust-proof: Equivalent to IEC Standard publication 529 IP5X
	Drop-proof: This camera clears company testing compliant with MIL-STD-810F Method; 516.5 Shock: Dropping onto plywood 3 cm thick from a height of 1.5 m		Freeze-proof: Allowable operating temperatures: -10°C to +40°C Note: Temperatures between -10°C and 0°C temporarily lower battery performance, reducing the time available for recording.

Caution :

- There is no guarantee that there will be no damages when the unit is used within the above-mentioned limits.
Scratches and dent caused by the impact if the unit is dropped, or other changes in appearance are not included in the warranty.
- Malfunction due to mishandling will void the warranty.
- Before use in water, be sure to read and understand the "Before Using Underwater or under Low Temperature" (☞ p. 8) .
- Close the terminal cover firmly until it clicks and confirm that the red sign completely goes off.
- Make sure that there is no damage to and no foreign material adhered to the packing inside the cover.
- Use within a water depth of 5 m and a duration of 30 minutes.
- The waterproof performance cannot be guaranteed if the camcorder is subject to impact such as dropping.
- Do not jump or dive into water holding the camcorder.
- Do not use the camcorder in strong water flows such as in rapids or under waterfalls. The strong water pressure may impair the waterproof performance.
- Do not immerse into hot spring, or hot water above 40°C.

Getting Started

Before Using Underwater or under Low Temperature

“Cautions on Using Underwater” (☞ p. 8)

“Maintenance after Use” (☞ p. 8)

“Cautions on Using under Low Temperature” (☞ p. 8)

“Cautions on Using under Low Temperature” (☞ p. 8)

Cautions on Using Underwater

Please take note of the followings when using this unit near water or underwater.

- **Ensure that the cover is closed tightly.**
“Opening the Terminal Cover (SD Card Cover)” (☞ p. 6)
- Ensure that the terminal cover and the gray waterproof seal are not damaged and that there are no foreign materials (such as hair, lint, sand or dust) adhered on the cover.
- Stop using the unit underwater if there are damages to the cover, etc. and consult your JVC dealer or the nearest service center.

- Use within a water depth of 5 m and a duration of 30 minutes.



- Do not open/close the cover or insert/remove an SD card or any cables while using underwater or on the beach, or if your hands contain water droplets or sands. Doing so may cause water to enter into the camera or malfunction.
- Do not subject the camera to high pressure or vibration resulted from swift current, waterfall or diving into water.
- The waterproof performance is not guaranteed if the camera is dropped or subjected to other impact shock. If the camera has been subjected to impact shock, consult your nearest service center.
- While shooting underwater, noise generated inside of the camera (zooming sounds, etc) may be picked up. This is not a malfunction.
- Do not immerse into hot spring, or hot water above 40°C. Doing so deteriorates waterproof performance.
- Keep away from hands with sun oil or sun screen. Doing so may cause discoloration or deterioration of material.
- This unit sinks underwater. Fasten the grip belt firmly to prevent losing the camera underwater.
- The accessories are not waterproof.
- Wi-Fi function is not available underwater.

Maintenance after Use

After using underwater or in dusty places, rinse the camera with water immediately and dry it completely.

- 1 Ensure that the terminal cover is closed.

- 2 Rinse with clean water.

Soak the camera in a container filled with enough water to immerse the camera completely, and rinse it gently.



- After using the camera under the sea or on the beach, immerse the camera in fresh water for about 10 minutes to remove salt particles, replace the water and rinse the camera.
- Open and close the LCD screen, and operate the buttons or zoom operations to get rid of sands or dusts in the gap.
- Do not rinse the camera under running tap water or strong pressure water.

- 3 Dry the camera.

Wipe the camera completely with a soft dry cloth and allow it to dry in a well-ventilated and shady location.

- Place the camera with the lens facing downward while the LCD monitor is closed, and leave it for approximately 10 minutes. (By doing so, microphone and LDC part are dried out easily.) Place the camera in a up right position on a dry cloth afterward Close the terminal cover after the camera is dried out completely.
- Wipe off any foreign materials or water droplets inside the cover.

- * If you leave the camera immersed in salt water or allow water droplets from the salt water to remain on the camera, this may cause corrosion, discoloration or deterioration of waterproof performance.
- * If you wipe or dry the camera with sand particles adhered, this may cause scratches on the camera.
- * Do not wash with chemicals, soap, neutral detergents, or alcohol.
- * Do not dry the camera with a hair dryer or other heat sources. This could impair its waterproof performance.

Cautions on Using under Low Temperature

- The performance of the battery will drop temporarily when the temperature is -10°C to 0°C, this will cause the remaining recording time to shorten.
- Charging cannot be performed when the surrounding temperature is below 10 °C.
- Turning on the camera while it is still cold will deteriorate the performance of the LCD monitor. Problems such as the screen becoming dark momentarily or residual image can occur.
- If snow or water droplets adhere to the camera under sub-zero temperature environment, ice can formed between the gaps around the buttons, speaker or microphone. This will cause difficulty in operating the buttons as well as decrease in the volume level.
- Direct contact with exposed metal part under cold temperature can cause the skin to stick on the metal part resulting in injuries such as frostbite. Do not touch with bare hands.

Other Precautions

- Do not leave the camera under low temperature in cold climates or under high temperature above 40 °C (such as under direct sunlight, inside a vehicle in the hot sun, or near a heater). This will cause deterioration of the waterproof performance.
- Malfunction due to mishandling will void the warranty.
- We are not responsible for any loss of data due to water entering into inside of the camera. Please be forewarned.
- It is recommended to replace the waterproof packing once a year to maintain the waterproof performance. Consult your nearest service center. (Subject to a fee)

Grip Adjustment



- 1 Open the pad
- 2 Adjust the length of the belt
- 3 Close the pad

Caution :

- Be sure to fasten the grip belt properly.
If the belt is loose, this unit may drop and result in injuries or damages.

Attaching the Core Filter

Attach a core filter to the AV cable that is connected to this unit.

The core filter reduces interference when this unit is connected to other devices.

Attaching core filter to the cable of the AC adapter and the optional AV cable (on the end connected to this unit) can reduce the interference generated when this unit is connected to an external device.

- Use the small core filter with the power cable, and the large core filter with the AV cable.
- Do not attach the core filter to the provided adapter cable.

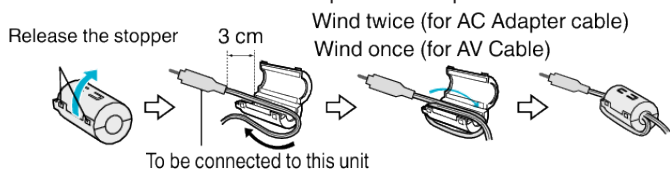

Inserting an SD Card

When a commercially available SD card is inserted, recordings can still be made to the card without stopping when the remaining recording time on the built-in memory runs out.

“Types of Usable SD Card” (☞ p. 11)

“Approximate Video Recording Time” (☞ p. 48)

- 1 Open the terminal cover.

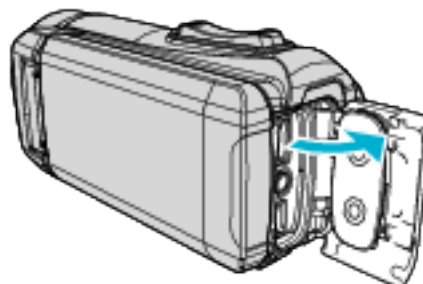

- 2 Close the LCD monitor to turn off this unit.

- 3 Insert an SD card.

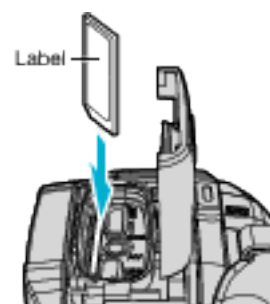

Warning

- Make sure not to insert the SD card in the wrong direction. It may cause damage to the unit and SD card.
- Before inserting or removing the SD card, close the LCD monitor and ensure that the POWER/ACCESS lamp goes off.
- Do not touch the metal contact area when inserting the SD card.

Memo :

- When “SEAMLESS RECORDING” is set to “ON”, recordings can still be made to the SD card without stopping when the remaining recording time on the built-in memory runs out.

“SEAMLESS RECORDING” (☞ p. 151)

- Both videos and still images can be recorded on one SD card. It is recommended to confirm the video operation of the SD card before usage.
- To record to an SD card, it is necessary to set the recording media to “SD CARD”.

“REC MEDIA FOR VIDEO” (☞ p. 165)

“REC MEDIA FOR IMAGE” (☞ p. 165)

- To use a new SD card, or SD card used on other devices, it is necessary to format (initialize) the SD card using “FORMAT SD CARD” from media settings.

“FORMAT SD CARD” (☞ p. 165)

Removing the Card

Push the SD card inward once, then pull it out straight.

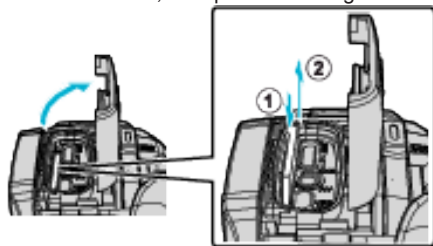

Types of Usable SD Card

The following SD cards can be used on this unit. Operations are confirmed on the SD cards from the following manufacturers.

- Panasonic
- TOSHIBA
- SanDisk

SD Card



- This unit supports 256 MB to 2 GB SD cards.
- Use a Class 4 or higher compatible SD card (2 GB) for video recording.

SDHC Card



- Use a Class 4 or higher compatible SDHC card (4 GB to 32 GB) for video recording.

SDXC Card



- Use a Class 4 or higher compatible SDXC card (Max. 128 GB) for video recording.

Memo :

- Using SD cards (including SDHC/SDXC cards) other than those specified above may result in recording failure or data loss.
- This unit is not guaranteed to operate with all SD cards. Some SD cards may not work due to specification changes, etc.
- Do not use a miniSD card or microSD card (even if the card is inserted in an adapter). It may cause malfunction.
- To record videos with "VIDEO QUALITY" set to "UXP", use of a Class 6 or higher compliant SDHC/SDXC card is recommended.
- To select "50p" in "SYSTEM SELECT", use a Class 6 or higher compliant SDHC/SDXC card.
- Class 4 and Class 6 are guaranteed to have a minimum transfer rate of 4 MB/s and 6 MB/s respectively during reading or writing of data.
- You can also use a Class 10 compliant SDHC/SDXC card.
- Both videos and still images can be recorded on one SD card. It is recommended to confirm the video operation of the SD card before usage.
- To protect the data, do not touch the terminals of the SD card.
- UHS-I SDHC/SDXC cards can be used in the same manner as standard SDHC/SDXC cards. UHS Speed Class is not supported.
- An SD card which is used for recording and/or editing on other devices may not be played back or edited on this unit.
- An SD card which is used for recording on this unit may not be used for playing back and/or editing on other devices.

When your computer cannot recognize the SDXC card

Confirm and update the OS of your computer.

Windows Vista	<ul style="list-style-type: none"> • Make sure that the operating system version is SP1 or higher. • Download and install the updating program (KB975823) from the following URL. 32 bit version http://www.microsoft.com/downloads/details.aspx?displaylang=ja&FamilyID=2d1abe01-0942-4f8a-abb2-2ad529de00a1 64 bit version http://www.microsoft.com/downloads/en/details.aspx?FamilyID=2d1abe01-0942-4f8a-abb2-2ad529de00a1
Windows 7	Download and install the updating program (KB976422) from the following URL. 32 bit version http://www.microsoft.com/downloads/details.aspx?displaylang=ja&FamilyID=3ee91fc2-a9bc-4ee1-aca3-2a9aff5915ea 64 bit version http://www.microsoft.com/downloads/details.aspx?displaylang=ja&FamilyID=73f766dd-7127-4445-b860-47084587155f
Mac OS X 10.4 Tiger / Mac OS X 10.5 Leopard	Not compatible.
Mac OS X 10.6 Snow Leopard	Update the OS version to 10.6.5 or later.

Using the Touch Screen

The LCD monitor of this unit is a touch panel which enables operations by touching the screen.

Icon operation buttons, thumbnails, and menu items are displayed on the touch screen according to the mode in use.

- There are two ways to operate the touch screen, namely “tap” and “drag”. The following are some examples.

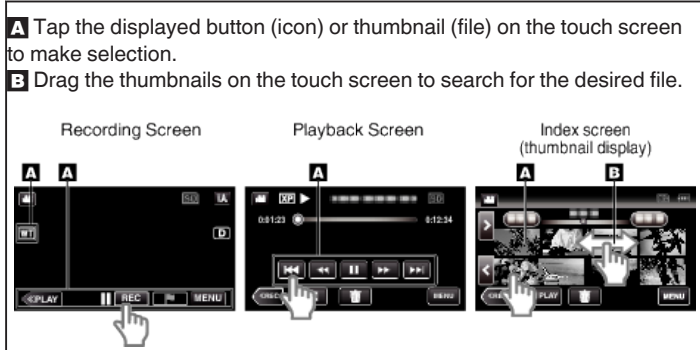

Memo :

- The touch screen of this unit is pressure-sensitive. When the touch screen does not respond smoothly, apply slightly more force to your fingertip.
- Tap the buttons (icons) on the touch screen accurately. The buttons may not respond if they are not tapped on the right area.
- Do not press or rub with excessive force.
- Do not operate the touch screen using an object with a sharp tip.
- Pressing two or more places at a time may cause a malfunction.
- Perform “TOUCH SCREEN ADJUST” if the reactive area of the screen is misaligned with the touched area. (Adjust by lightly tapping with a corner of an SD card, etc. Do not press with an object with a sharp tip or do not press hard.)

“Adjusting the Touch Panel” (p. 12)

- You cannot operate the touch screen under water. Lock the screen to prevent operation errors.

“Shooting under Water” (p. 34)

Locking the Screen (when Shooting Underwater)

Lock the screen before using this unit underwater to prevent operation errors on the touch screen.

- Once the screen is locked, operations on the touch screen are disabled.
- The START/STOP (recording) button and the zoom lever can be used while the screen is locked.
- You can set for both video and still image modes.

Setting the “SCREEN LOCK”

- 1 Check that the unit is in the recording mode.
- 2 Tap “MENU”.
- 3 Tap “RECORD SETTING”.
- 4 Tap “SCREEN LOCK”.

- The button appears on the screen.



To cancel “SCREEN LOCK”

Tap the button.

Memo :

- Once “SCREEN LOCK” is set, only the button on the touch screen can be operated.
- “SCREEN LOCK” cannot be set for the following cases:
 - during recording
 - when “TIME-LAPSE RECORDING”, “RECORDING EFFECT” or “DATE/TIME RECORDING” has been set

Adjusting the Touch Panel

Adjusts the response position of the buttons on the touch screen.

- 1 Tap “MENU”.

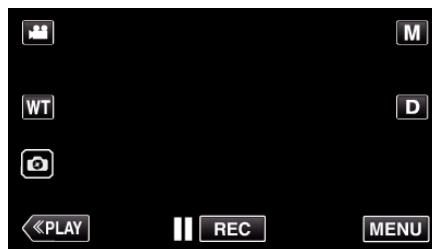

- 2 Tap “SETUP”.

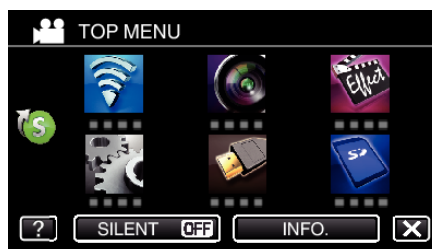

- 3 Tap “TOUCH SCREEN ADJUST”.

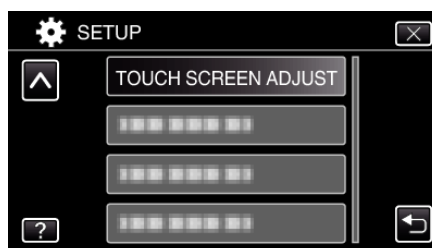

- The touch screen adjustment screen appears.

- 4 Tap “+”. (3 times in total)



- Keep tapping “+” as its position changes with every tap.
- If areas other than the “+” mark are tapped, errors will occur. Make sure to tap the “+” mark.

- 5 Tap “+” again to confirm the adjusted positions. (3 times in total)



- Keep tapping “+” as its position changes with every tap.

6 Tap "OK".

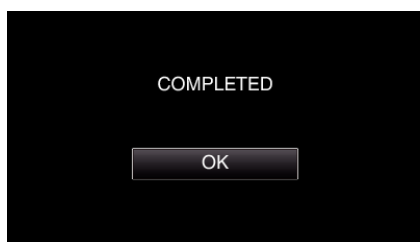

- Setting ends and returns to the menu screen.



Caution :

- Do not tap areas other than the "+" mark during touch screen adjustment (steps 4 - 5). Doing so may cause the touch screen to malfunction.









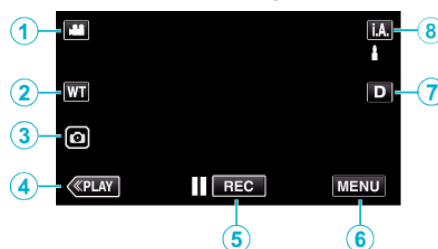



Memo :

- Adjust by lightly tapping with a corner of an SD card, etc.
- Do not press with an object with a sharp tip or do not press hard.

Names of Buttons and Functions on the LCD Monitor

The following screens are displayed during the  video and  still image modes, and operate as touch screens.

Recording Screen (Video/Still Image)

- 1**  (Video/Still Image) Mode Button
 - Switches between  video and  still image modes.
- 2** Zoom Button
 - "Zooming" (☞ p. 27)
- 3** Still Image Recording Button
 - Records still images during video recording.
 - "Capturing Still Images During Video Recording" (☞ p. 24)
- 4** Playback Mode Button
 - Switches to the playback mode.
- 5** Recording Start/Stop Button
 -  REC: Video Recording Start Button
 -  REC: Video Recording Stop Button
- 6** Menu Button
 - "Operating the Menu" (☞ p. 147)
- 7** Display Button
 - Switches the display between full () and simple () with every tap of the button.
 - Simple display: Some displays disappear automatically when the screen is not operated.
 - Full display: Displays everything. The display button changes from  to .
 - When the power is turned off, the display setting will revert to simple display (.
- 8** Recording Mode Button
 - Switches the recording mode (, Intelligent Auto/ Manual).

Playback Screen (Video)

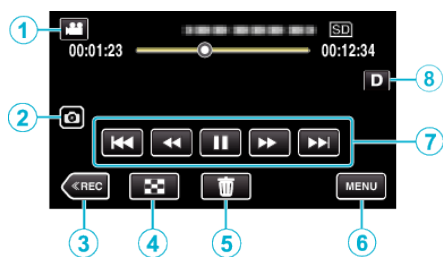

- When this unit is not operated, the operation buttons on the LCD monitor disappear automatically. Tap on the screen to display the operation buttons again.

- 1** (Video/Still Image) Mode Button
 - Switches between video and still image modes.
- 2** Video Scene Capture Button
 - Displayed when playback is paused.
 - Saves one scene of the video being played back as a still image.
- 3** Recording Mode Button
 - Switches to the recording mode.
- 4** Index Screen (Thumbnail Display) Button
 - Returns to the index screen (thumbnail display).
 - “Operation Buttons for Video Playback” (☞ p. 50)
- 5** Delete Button
 - “Deleting the Currently Displayed File” (☞ p. 61)
- 6** Menu Button
 - “Operating the Menu” (☞ p. 147)
- 7** Operation Buttons
 - “Operation Buttons for Video Playback” (☞ p. 50)
- 8** Display Button
 - Switches the display between full (**Df**) and simple (**D**) with every tap of the button.
 - Simple display: Some displays disappear automatically when the screen is not operated.
 - Full display: Displays everything. The display button changes from **D** to **Df**.
 - When the power is turned off, the display setting will revert to simple display (**D**).

Playback Screen (Still Image)

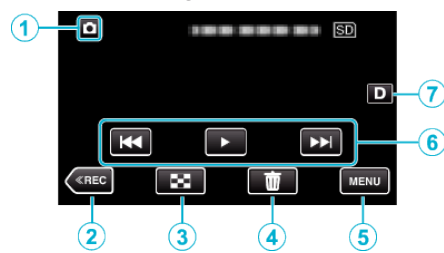

- When this unit is not operated, the operation buttons on the LCD monitor disappear automatically. Tap on the screen to display the operation buttons again.

- 1** (Video/Still Image) Mode Button
 - Switches between video and still image modes.
- 2** Recording Mode Button
 - Switches to the recording mode.
- 3** Index Screen (Thumbnail Display) Button
 - Returns to the index screen (thumbnail display).
 - “Operation Buttons for Still Image Playback” (☞ p. 56)
- 4** Delete Button
 - “Deleting the Currently Displayed File” (☞ p. 61)
- 5** Menu Button
 - “Operating the Menu” (☞ p. 147)
- 6** Operation Buttons
 - “Operation Buttons for Still Image Playback” (☞ p. 56)
- 7** Display Button
 - Switches the display between full (**Df**) and simple (**D**) with every tap of the button.
 - Simple display: Some displays disappear automatically when the screen is not operated.
 - Full display: Displays everything. The display button changes from **D** to **Df**.
 - When the power is turned off, the display setting will revert to simple display (**D**).

Index Screen (Thumbnail Display) Display

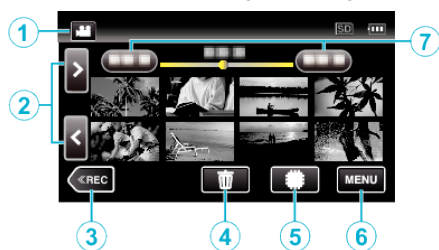

- 1** (Video/Still Image) Mode Button
 - Switches between video and still image modes.
- 2** Page Forward/Back Button
 - “Operation Buttons for Video Playback” (☞ p. 50)
 - “Operation Buttons for Still Image Playback” (☞ p. 56)
- 3** Recording Mode Button
 - Switches to the recording mode.
- 4** Delete Button
 - “Deleting Selected Files” (☞ p. 61)
 - “Deleting the Currently Displayed File” (☞ p. 61)
- 5** Playback Media Button
 - Switches between SD card and built-in memory.
- 6** Menu Button
 - “Operating the Menu” (☞ p. 147)
- 7** Date Button
 - “Operation Buttons for Video Playback” (☞ p. 50)
 - “Operation Buttons for Still Image Playback” (☞ p. 56)

Menu screen (recording mode)



- 1** Wi-Fi menu
 - “Wi-Fi Capabilities” (☞ p. 104)
- 2** Shortcut Menu
 - “Operating the Shortcut Menu” (☞ p. 148)
- 3** SETUP Menu
 - “SETUP (video/still image)” (☞ p. 162)
- 4** Help Button
 - Tap the ? (help) button and item to display descriptions.
- 5** SILENT Button
 - “Using the Silent Mode” (☞ p. 24)
- 6** CONNECTION SETTINGS Menu
 - “CONNECTION SETTINGS (video/still image)” (☞ p. 164)
- 7** INFO. Button
 - “Checking the Remaining Recording Time” (☞ p. 47)
- 8** Close Button
 - Exit the menu.
- 9** MEDIA SETTINGS Menu
 - “MEDIA SETTINGS (video/still image)” (☞ p. 165)
- 10** SPECIAL RECORDING Menu
 - “SPECIAL RECORDING Menu (video)” (☞ p. 154)
- 11** RECORD SETTING Menu
 - “RECORD SETTING Menu (video)” (☞ p. 150)
 - “RECORD SETTING Menu (still image)” (☞ p. 155)

Menu screen (playback mode)

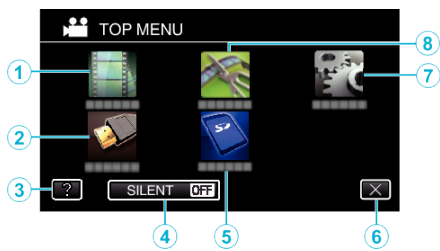

- 1 **PLAYBACK SETTING Menu**
 "PLAYBACK SETTING Menu (video)" (☞ p. 158)
 "PLAYBACK SETTING Menu (still image)" (☞ p. 160)
- 2 **CONNECTION SETTINGS Menu**
 "CONNECTION SETTINGS (video/still image)" (☞ p. 164)
- 3 **Help Button**
 Tap the ? (help) button and item to display descriptions.
- 4 **SILENT Button**
 "Using the Silent Mode" (☞ p. 24)
- 5 **MEDIA SETTINGS Menu**
 "MEDIA SETTINGS (video/still image)" (☞ p. 165)
- 6 **Close Button**
 Exit the menu.
- 7 **SETUP Menu**
 "SETUP (video/still image)" (☞ p. 162)
- 8 **EDIT Menu**
 "EDIT Menu (video)" (☞ p. 159)
 "EDIT Menu (still image)" (☞ p. 161)

Clock Setting

The "SET DATE/TIME!" screen appears when you turn on this unit for the first time after purchase, when it has not been used for a long time, or when the clock is not set yet.

Set the clock before recording.

- 1 Open the LCD monitor.

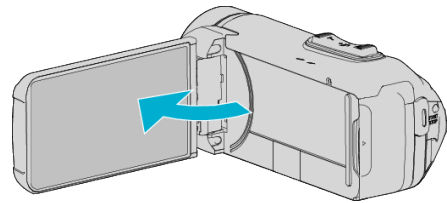

- The unit turns on.
- When the LCD monitor is closed, the unit turns off.

- 2 Tap "YES" when "SET DATE/TIME!" is displayed.



- 3 Set the date and time.

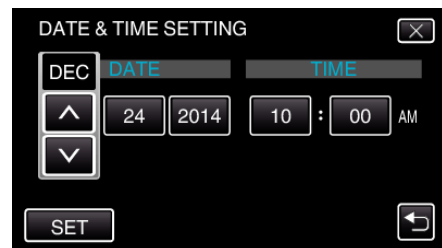

- When the year, month, day, hour, or minute item is tapped, "∧" and "∨" will be displayed.
- Tap ∧ or ∨ to adjust the year, month, day, hour, and minute.

- 4 After setting the date and time, tap "SET".

- 5 Select the region where you live and tap "SAVE".



- Time difference between the selected city and the GMT (Greenwich Mean Time) is displayed.
- Tap < or > to select the city name.

Memo :

- The clock can be reset again later.
 "Resetting the Clock" (☞ p. 17)
- When using this unit overseas, you can set it to the local time for recording.
 "Setting the Clock to Local Time when Traveling" (☞ p. 20)
- The clock is reset about one month after the battery is depleted. "SET DATE/TIME!" is displayed the next time you turn on this unit. Set the clock again after charging the battery.

Resetting the Clock

Set the clock with "DATE & TIME" from the menu.

- 1 Tap "MENU".

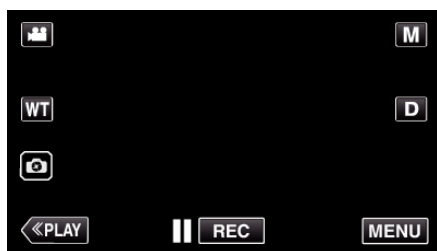

- 2 Tap "SETUP".



- 3 Tap "DATE & TIME".

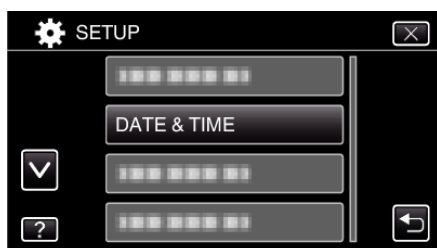

- Tap ^ or v to scroll the screen.

- 4 Tap "CLOCK SETTING".

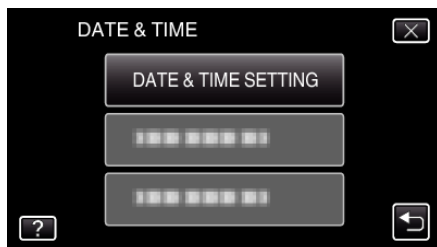

- 5 Set the date and time.

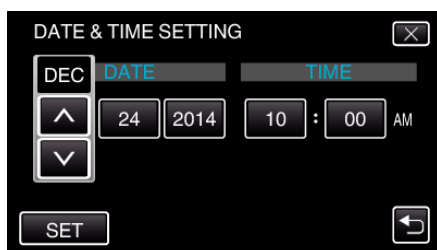

- When the year, month, day, hour, or minute item is tapped, "^" and "v" will be displayed.
- Tap ^ or v to adjust the year, month, day, hour, and minute.

- 6 After setting the date and time, tap "SET".

- 7 Select the region where you live and tap "SAVE".

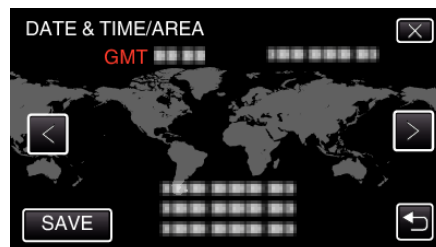

- Time difference between the selected city and the GMT (Greenwich Mean Time) is displayed.
- Tap < or > to select the city name.

Changing the Display Language

The language on the display can be changed.

1 Tap "MENU".

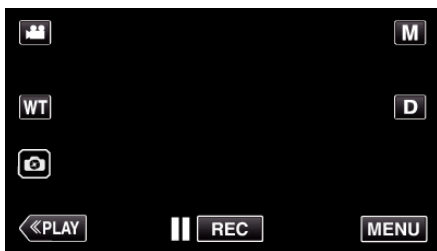

2 Tap "SETUP".

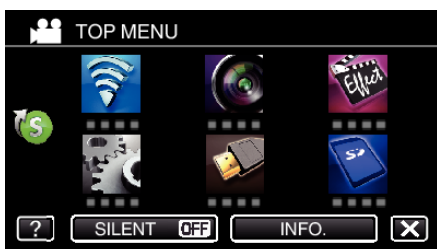

3 Tap "LANGUAGE".

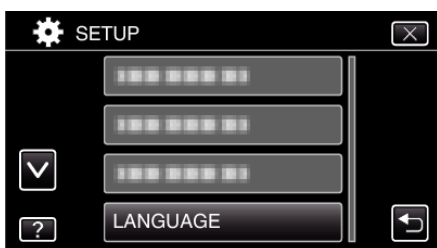

- Tap ^ or v to scroll the screen.

4 Tap to the desired language.

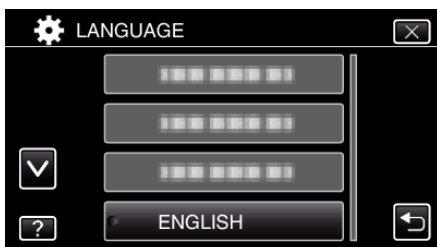

- Tap ^ or v to scroll the screen.

Holding this Unit

When holding this unit, keep your elbows close to your sides to prevent camera shake.



- Hold the LCD monitor with your left hand and adjust the angle accordingly. Holding the LCD monitor with your left hand helps to stabilize the camera for recording.

Caution :

- Be careful not to drop this unit during transportation.
- Guardians should pay close attention when this unit is used by children.

Memo :

- If camera shake is excessive, use the image stabilizer. "Reducing Camera Shake" (p. 43)

Getting Started

Setting the Clock to Local Time when Traveling

Change the date and time display to the local time by selecting your travel destination in "AREA SETTING" of "DATE & TIME".

Restore the region settings after you returned from the trip.

1 Tap "MENU".

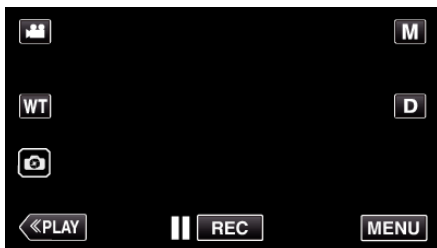

2 Tap "SETUP".

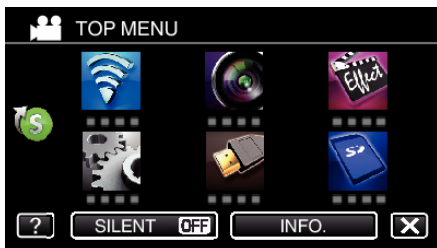

3 Tap "DATE & TIME".

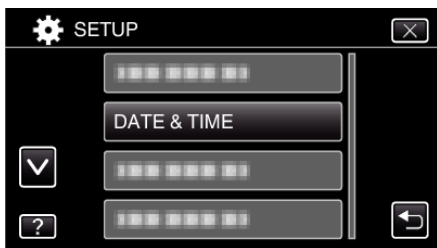

- Tap ^ or v to scroll the screen.

4 Tap "AREA SETTING".



5 Select the area you are traveling to and tap "SAVE".



- Time difference between the selected city and the GMT (Greenwich Mean Time) is displayed.
- Tap < or > to select the city name.

Memo :

- Setting "AREA SETTING" changes the clock time such that time difference is accounted for.
After returning to your country, re-select the region that was set initially to restore the original clock settings.

Setting Daylight Saving Time

When "ON" is selected in "DST SETTING" of "DATE & TIME", the time is set 1 hour ahead.

1 Tap "MENU".

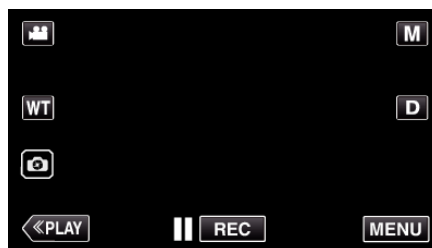

2 Tap "SETUP".

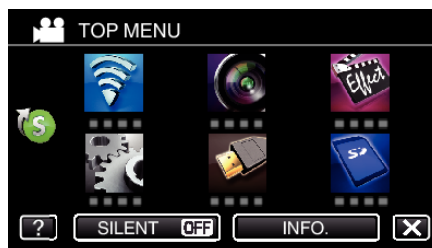

3 Tap "DATE & TIME".

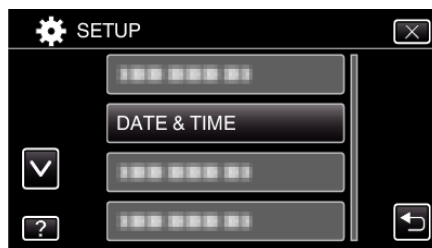

- Tap ^ or v to scroll the screen.

4 Tap "DST SETTING".

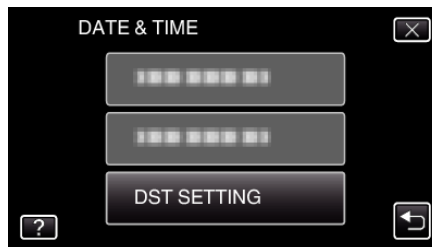

5 Tap "ON".

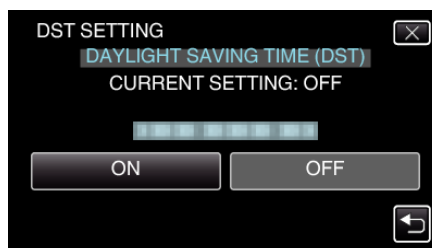

Memo :

- What is daylight saving time?
Daylight saving time is the system of setting the clock 1 hour ahead for a fixed period in summer.
It is used mainly in the Western countries.
- Restore the daylight saving time settings after you returned from the trip.

Optional Accessories

Product Name	Description
HDMI Mini Cable <ul style="list-style-type: none"> • VX-HD310 • VX-HD315 	<ul style="list-style-type: none"> • Allows viewing in high picture quality when connected to a TV. • Transmits video, audio, and control signals between devices.
AV Cable <ul style="list-style-type: none"> • QAM1322-001 	<ul style="list-style-type: none"> • Connects to TV, DVD recorder, VCR, etc. “Connecting via the AV Connector” (☞ p. 60) “Dubbing Files to a Disc by Connecting to a DVD Recorder” (☞ p. 84) “Dubbing Files to a VHS Tape by Connecting to a VCR” (☞ p. 85) <ul style="list-style-type: none"> • When using the AV cable, attach the core filter supplied with this unit for the AV cable. “Attaching the Core Filter” (☞ p. 10)

Memo :

- The optional accessories above may not be supported in some regions.
- For more information, refer to the catalog.
- For details on the provided accessories, refer to “Verifying the Accessories”.

“Verifying the Accessories” (☞ p. 4)

Taking Videos in Auto Mode

You can record without worrying about the setting details by using the **i.A.** Intelligent Auto mode. Settings such as exposure and focus will be adjusted automatically to suit the shooting conditions.

- In case of specific shooting scenes such as person etc., its icon is displayed on the screen.
- Before recording an important scene, it is recommended to conduct a trial recording.

1 Open the LCD monitor.

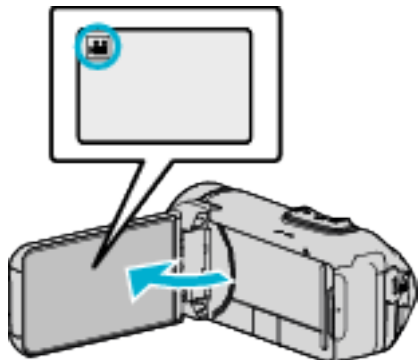

- Check if the recording mode is .
- If the mode is still image, tap on the recording screen to display the mode switching screen. Tap to switch the mode to video.

2 Check if the recording mode is **i.A.** Intelligent Auto.

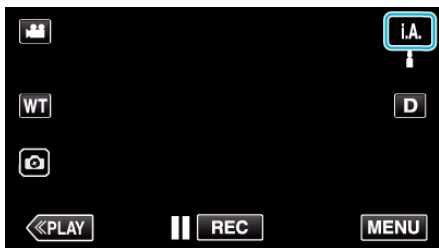

- If the mode is **M** Manual, tap **M** on the recording screen to display the mode switching screen. Tap **i.A.** to switch the recording mode to Intelligent Auto.

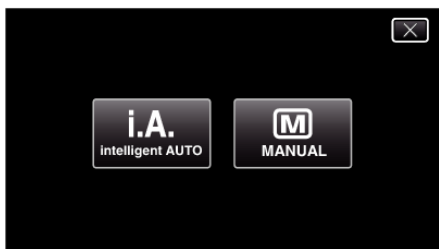

3 Press the START/STOP button to start recording.

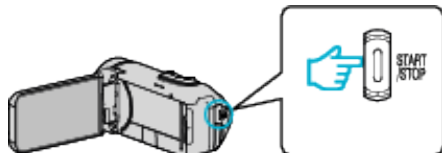

- Press again to stop.
- Some displays disappear after approximately 3 seconds. Use the **D** button to change the displays.

Indications for Video Recording

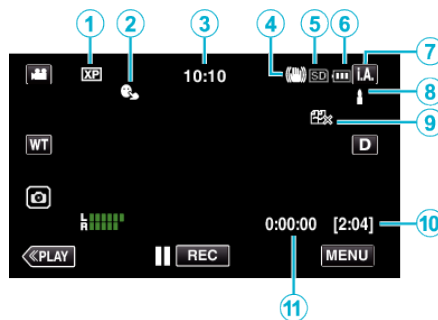

	Display Icon	Description
①	Video Quality	Displays the icon of the "VIDEO QUALITY" setting selected in the recording menu. "VIDEO QUALITY" (p. 152)
②	TOUCH PRIORITY AE/AF	Displays the setting of "TOUCH PRIORITY AE/AF". By default, it is set to "FACE TRACKING". "Capturing Subjects Clearly (TOUCH PRIORITY AE/AF)" (p. 42)
③	Time	Displays the current time. "Clock Setting" (p. 16)
④	Image Stabilizer	Displays the image stabilizer setting. "Reducing Camera Shake" (p. 43)
⑤	Recording Media	Displays the icon of the media where videos are recorded to. The recording media can be changed. "REC MEDIA FOR VIDEO" (p. 165)
⑥	Battery Indicator	Displays the approximate remaining battery power during use. "Checking the Remaining Recording Time" (p. 47)
⑦	Recording Mode	Displays the current recording mode of i.A. (Intelligent Auto) or M (Manual). Current shooting mode is displayed.
⑧	Setting Scenes of Intelligent Auto	Displays scenes detected automatically in the Intelligent Auto function. Multiple scenes may be detected.
⑨	SEAMLESS RECORDING	Displays the seamless recording icon when it is set. appears if seamless recording cannot be performed. "SEAMLESS RECORDING" (p. 151)
⑩	Remaining Recording Time	Displays the remaining time for video recording. "Checking the Remaining Recording Time" (p. 47)
⑪	Scene Counter (Recorded Time)	Displays the elapsed time of the video that is currently being recorded.

Scenes of Intelligent Auto

Display Icon	Description
	Captures one's skin beautifully.
	Allows people to be captured naturally.
	Record a group of people with the most suitable settings.
	Records while focusing on a near object.
	Focuses at a far distance and captures a sharp image with vivid colors.
	Records in dark places with minimal noise in the overall image.
	Allows night scenes to be captured accurately with minimal noise in the overall image.
	Prevents colors from fading even when recording in a bright environment, such as snowfield and beaches.
	Prevents colors from fading when recording a subject in a spotlight.
	Reproduces the green color of trees vividly.
	Reproduces the colors of sunset naturally.
	Adjusts settings so that the subject does not appear too dark due to backlight.
	Records while emphasizing the brightness of the colors.
	Reproduces the natural colors of the outdoors during the day.
	Reproduces the natural colors of the indoors in a cold-color illumination.
	Reproduces the natural colors of the indoors in a warm-color illumination.
	Selects the most suitable settings for handheld shooting.
	Selects the most suitable settings when a tripod is used for shooting.

Memo :

- Scenes can be detected according to the shooting conditions and automatically adjusted in Intelligent Auto mode.
- Multiple scenes may be detected depending on the recording conditions.
- Some functions may not work properly depending on the shooting conditions.

Operation Buttons for Video Recording

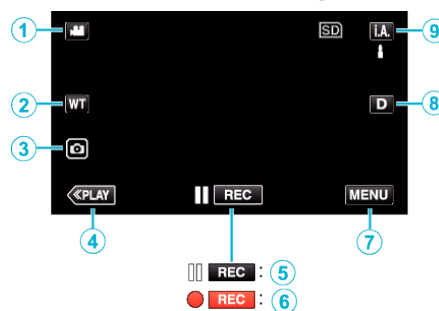

	Operation Buttons	Description
①	Video/Still Image Mode 	Switches between video and still image modes.
②	WT Zoom	Allows the same functions as the zoom lever to be performed. Camera shake that often occurs when using the zoom lever can be minimized. "Zooming" (p. 27)
③	Still Image Recording 	Tap this button to record a still image during video recording. "Capturing Still Images During Video Recording" (p. 24)
④	Playback Mode	Switches to the playback mode.
⑤/⑥	Recording Start Record-Standby 	Functions as the START/STOP button.
⑦	MENU	Displays the various menus of video recording. "Operating the Menu" (p. 147)
⑧	Display Button D	Switches the display between full (D?) and simple (D) with every tap of the button. <ul style="list-style-type: none"> • Simple display: Some displays disappear automatically when the screen is not operated. • Full display: Displays everything. The display button changes from D to D?. • When the power is turned off, the display setting will revert to simple display (D).
⑨	Recording Mode i.A./M	Switches between the i.A. Intelligent Auto and M Manual recording mode.

Using the Silent Mode

When the Silent mode is used, the LCD monitor darkens and operation sounds will not be output. Use this mode to record quietly in dark places such as during a performance.

-  appears when "SILENT MODE" is set to "ON".
- To mute only the operating sound, set "OPERATION SOUND" in the menu to "OFF" instead of using the silent mode.

Operating procedure

1 Tap "MENU".

- The top menu appears.

2 Tap "SILENT".

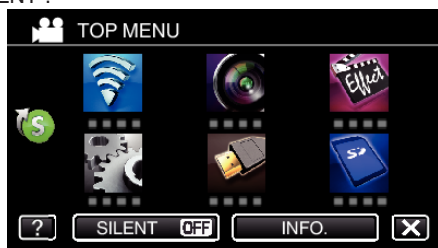

3 Tap "ON".

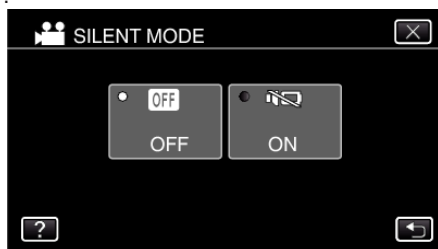

Useful Settings for Recording

- When "AUTO POWER OFF" is set to "ON", this unit turns itself off automatically to conserve power when it is not operated for 5 minutes. (When using the AC adapter, this unit goes into standby mode.)

"AUTO POWER OFF" (☞ p. 163)

- When "TOUCH PRIORITY AE/AF" is set to "FACE TRACKING", this unit detects faces and automatically adjusts its brightness and focus to record the faces more clearly.

"Capturing Subjects Clearly (TOUCH PRIORITY AE/AF)" (☞ p. 42)

- If the remaining space on the built-in memory runs out while "SEAMLESS RECORDING" is set to "ON", recording continues after switching to the SD card.

- When "DATE/TIME RECORDING" is used, the date and time can be recorded together with the video.

"Recording Videos with Date and Time" (☞ p. 46)

Caution :

- Do not expose the lens to direct sunlight.
- While this unit may be used with the LCD monitor reversed and closed, the temperature rises more easily. Leave the LCD monitor open when using this unit for long periods of time, or in places exposed to direct sunlight or high temperatures.
- The power may turn off to protect the circuit if the temperature of this unit rises too much.
- If the temperature of this unit rises during recording, ● **REC** changes color to yellow as a notification.
- Do not remove the SD card while the POWER/ACCESS lamp is lighted. The recorded data may become unreadable. Before inserting or removing the SD card, close the LCD monitor and ensure that the POWER/ACCESS lamp goes off.

"Inserting an SD Card" (☞ p. 10)

- This unit is a microcomputer-controlled device. Electrostatic discharge, external noise and interference (from a TV, a radio, etc.) might prevent it from functioning properly. In such a case, close the monitor screen to turn off the power and remove the AC adapter, then press the Reset button to reset this unit.

"Resetting this Unit" (☞ p. 7)

- Disclaimer

- We shall not be held responsible for loss of recorded contents when recording videos/audio or playback cannot be operated due to malfunctions in this unit, provided parts, or SD card.
- Once deleted, recorded contents (data), including data loss due to malfunctions in this unit, cannot be restored. Please be forewarned.
- JVC will not be responsible for any lost data.
- In order for quality improvement, defective recording medium is subject to be analyzed. Therefore, it may not be returned.

Memo :

- Check the remaining recording time in the media before you start shooting. If there is not enough space, move (copy) the data to a computer or disc.
- When there are many files in the media, it may take time for them to be displayed on the playback screen. Wait for a while as the POWER/ACCESS lamp blinks, indicating normal operation.
- Do not forget to make copies after recording!
- Recording stops automatically as it cannot be performed for 12 or more consecutive hours according to specifications. (It may take some time to resume recording.)
- You can record or play back videos while the AC adapter is connected for charging. (However, the charging time will be longer than usual. In addition, the remaining battery power may decrease according to conditions.)
If the internal temperature rises when using the unit, stop the charging temporarily. (The CHARGE lamp goes off.)
- Depending on the subject and shooting conditions, recording may not be performed properly even in the Intelligent Auto mode.
- Depending on the shooting conditions, the four corners of the screen may appear dark, but this is not a malfunction. In this case, change the shooting conditions by moving the zoom lever, etc.

Capturing Still Images During Video Recording

Still images can be captured by tapping the  button while in the video mode (standby or recording).



- "PHOTO" lights up on the screen when a still image is being captured.



Memo :

- The size of the still image that is captured in the video mode is 1,920 x 1,080.
- Operation is invalid under the following conditions:
 - when menu is being displayed
 - when remaining recording time or battery power is being displayed
 - when any functions in "SPECIAL RECORDING" is set
 - when the AV cable is connected to the AV connector.
 - when the HDMI cable is connected and a resolution other than 1080i is output.

Taking Still Images in Auto Mode

You can record without worrying about the setting details by using the **i.A.** Intelligent Auto mode.

- 1 Open the LCD monitor.

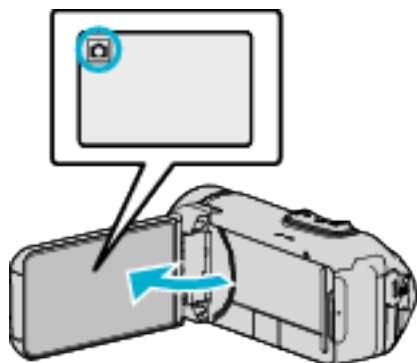

- Check if the recording mode is .
- If the mode is video, tap on the recording screen to display the mode switching screen. Tap to switch the mode to still image.

- 2 Check if the recording mode is **i.A.**, Intelligent Auto.

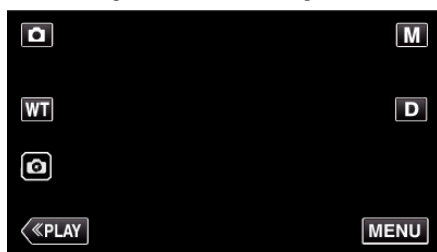

- If the mode is **M** Manual, tap **M** on the recording screen to display the mode switching screen. Tap **i.A.** to switch the recording mode to Intelligent Auto.

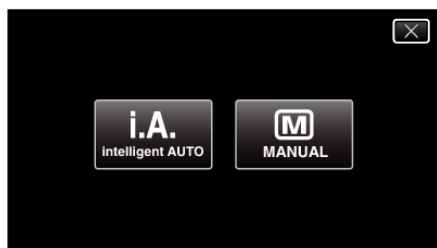

- 3 Press the START/STOP button.

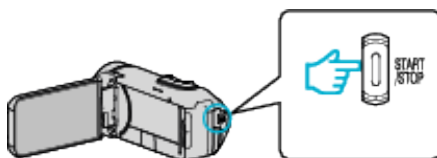

- PHOTO lights up when a still image is being captured.

Memo :

- Depending on the subject and shooting conditions, recording may not be performed properly even in the Intelligent Auto mode.

■ Start recording after adjusting the focus

- 1 Press and hold the button on the touch screen until the focus is adjusted.

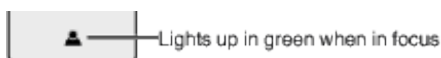

- 2 Remove your finger from the button to release the shutter.

Available only when "SHUTTER MODE" is set to "RECORD ONE SHOT".

Indications During Still Image Recording

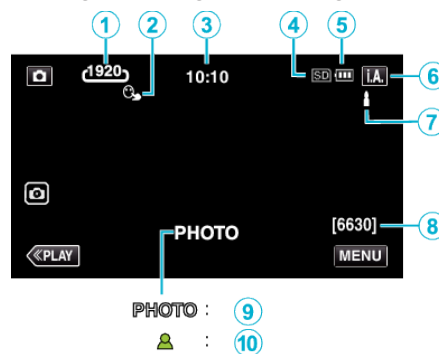

- Some displays disappear after approximately 3 seconds. Use the **D** button to change the displays.

	Display Icon	Description
①	Image Size	Displays the icon of the image size. • The size of still images can be changed. "IMAGE SIZE" (☞ p. 156)
②	TOUCH PRIORITY AE/AF	Displays the setting of "TOUCH PRIORITY AE/AF". By default, it is set to "FACE TRACKING". "Capturing Subjects Clearly (TOUCH PRIORITY AE/AF)" (☞ p. 42)
③	Time	Displays the current time. "Clock Setting" (☞ p. 16)
④	Recording media	Displays the icon of the media where still images are recorded to. The recording media can be changed. "REC MEDIA FOR IMAGE" (☞ p. 165)
⑤	Battery Indicator	Displays the approximate remaining battery power during use. "Checking the Remaining Recording Time" (☞ p. 47)
⑥	Recording Mode	Displays the current recording mode of i.A. (Intelligent Auto) or M (Manual).
⑦	Setting Scenes of Intelligent Auto	Displays scenes detected automatically in the Intelligent Auto function. Multiple scenes may be detected.
⑧	Remaining Number of Shots	Displays the remaining number of shots for still image recording. "Approximate Number of Still Images (Unit: Number of Shots)" (☞ p. 48)
⑨	Recording in Progress	"PHOTO" appears when a still image is being captured.
⑩	Focus	Lights up in green when focused.

■ Scenes of Intelligent Auto

Display Icon	Description
	Captures one's skin beautifully.
	Allows people to be captured naturally.
	Record a group of people with the most suitable settings.
	Records while focusing on a near object.
	Focuses at a far distance and captures a sharp image with vivid colors.
	Records in dark places with minimal noise in the overall image.
	Allows night scenes to be captured accurately with minimal noise in the overall image.
	Prevents colors from fading even when recording in a bright environment, such as snowfield and beaches.
	Prevents colors from fading when recording a subject in a spotlight.
	Reproduces the green color of trees vividly.
	Reproduces the colors of sunset naturally.
	Adjusts settings so that the subject does not appear too dark due to backlight.
	Records while emphasizing the brightness of the colors.
	Reproduces the natural colors of the outdoors during the day.
	Reproduces the natural colors of the indoors in a cold-color illumination.
	Reproduces the natural colors of the indoors in a warm-color illumination.
	Selects the most suitable settings for handheld shooting.
	Selects the most suitable settings when a tripod is used for shooting.

Memo :

- Scenes can be detected according to the shooting conditions and automatically adjusted in Intelligent Auto mode.
- Multiple scenes may be detected depending on the recording conditions.
- Some functions may not work properly depending on the shooting conditions.

Operation Buttons for Still Image Recording

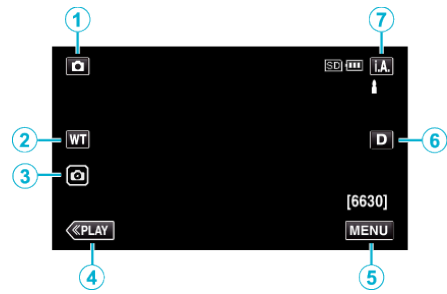

	Operation Buttons	Description
①	Video/Still Image Mode 	Switches between video and still image modes.
②	WT Zoom	Allows the same functions as the zoom lever to be performed. Camera shake that often occurs when using the zoom lever can be minimized. "Zooming" (☞ p. 27)
③	Still Image Recording 	Allows you to take still images using the touch panel. Pressing and holding the button allows you to adjust the focus before shooting. "Start recording after adjusting the focus" (☞ p. 25)
④	Playback Mode	Switches to the playback mode.
⑤	MENU	Displays the various menus of still image recording. "Operating the Menu" (☞ p. 147)
⑥	Display Button D	Switches the display between full (D_F) and simple (D) with every tap of the button. <ul style="list-style-type: none"> • Simple display: Some displays disappear automatically when the screen is not operated. • Full display: Displays everything. The display button changes from D to D_F. • When the power is turned off, simple display (D) will be set.
⑦	Recording Mode i.A./M	Switches between the i.A. Intelligent Auto and M Manual recording mode.

Using the Silent Mode

When the Silent mode is used, the LCD monitor darkens and operation sounds will not be output. Use this mode to record quietly in dark places such as during a performance.

-  appears when "SILENT MODE" is set to "ON".
- To mute only the operating sound, set "OPERATION SOUND" in the menu to "OFF" instead of using the silent mode.

"OPERATION SOUND" (☞ p. 163)

Operating procedure

- 1 Tap "MENU".
- 2 The top menu appears.
- 3 Tap "SILENT".



- 3 Tap "ON".

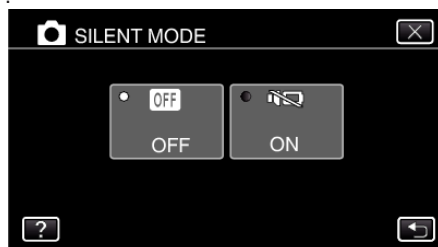

Useful Settings for Recording

- When "AUTO POWER OFF" is set to "ON", this unit turns itself off automatically to conserve power when it is not operated for 5 minutes. (When using the AC adapter, this unit goes into standby mode.)
"AUTO POWER OFF" (☞ p. 163)
- When "TOUCH PRIORITY AE/AF" is set to "FACE TRACKING", this unit detects faces and automatically adjusts its brightness and focus to record the faces more clearly.
"Capturing Subjects Clearly (TOUCH PRIORITY AE/AF)" (☞ p. 42)

Caution :

- Do not expose the lens to direct sunlight.
- While this unit may be used with the LCD monitor reversed and closed, the temperature rises more easily. Leave the LCD monitor open when using this unit for long periods of time, or in places exposed to direct sunlight or high temperatures.
- The power may turn off to protect the circuit if the temperature of this unit rises too much.
- Do not remove the AC adapter or SD card when the POWER/ACCESS lamp is lighted. The recorded data may become unreadable.
- This unit is a microcomputer-controlled device. Electrostatic discharge, external noise and interference (from a TV, a radio, etc.) might prevent it from functioning properly. In such a case, close the monitor screen to turn off the power and remove the AC adapter, then press the Reset button to reset this unit.

"Resetting this Unit" (☞ p. 7)

Memo :

- Before recording an important scene, it is recommended to conduct a trial recording.
- Depending on the shooting conditions, the four corners of the screen may appear dark, but this is not a malfunction. In this case, change the shooting conditions by moving the zoom lever, etc.

Zooming

The angle of view can be adjusted using zoom.

- Use the W end (wide angle end) to shoot a wider field of view.
- Use the T end (telephoto end) to magnify the subject for shooting.



W (Wide Angle End)



T (Telephoto End)

- The following zoom options are available:
 - Optical zoom (1 - 40x)
 - Dynamic zoom (41 - 60x)
 - Digital zoom (41 - 200x)
- You can also use the zoom (WT) button on the touch screen to zoom.
- Tap the WT button, then press and hold the T (telephoto end) or W (wide angle end) button.

Zoom Button (T/W)



Memo :

- When digital zoom is used, the image becomes grainy as it is digitally enlarged.
- The zoom ratio range can be changed.

"ZOOM" (☞ p. 152)

Manual Recording

You can adjust settings, such as brightness, by using the manual mode. Manual recording can be set for both video and still image modes.

1 Open the LCD monitor.

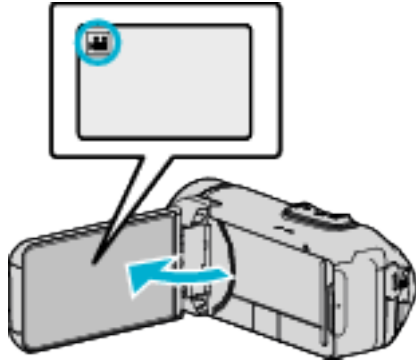

- Set the recording mode to either video or still image.
- To switch the mode between video and still image, tap or on the recording screen to display the mode switching screen. Tap or to switch the mode to video or still image respectively.

2 Select the Manual recording mode.



- If the mode is **i.A.**, Intelligent Auto, tap **i.A.** on the recording screen to display the mode switching screen. Tap **M** to switch the recording mode to Manual.

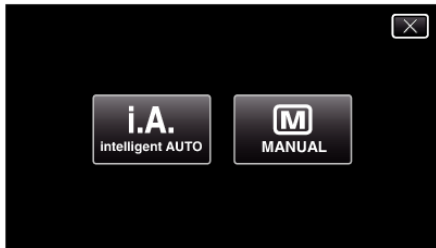

3 Tap "MENU".

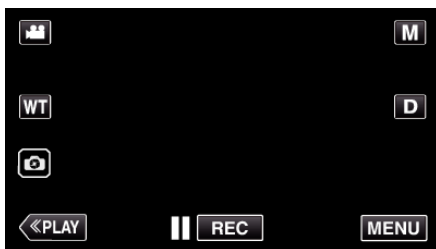

- The top menu appears.

4 Tap "RECORD SETTING".

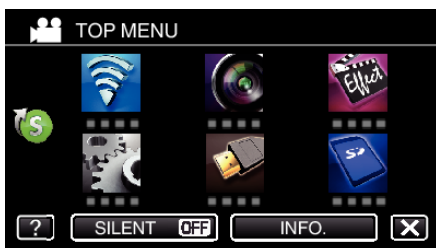

5 Tap the item to set manually.

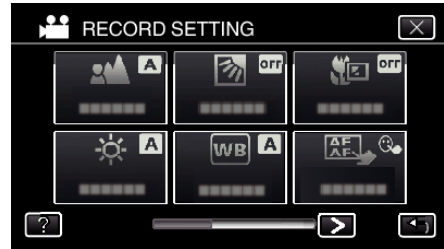

- For details on the various manual settings, refer to "Manual Recording Menu".

Manual Recording Menu

The following items can be set.

Name	Description
FOCUS	<ul style="list-style-type: none"> • Use manual focus if the subject is not focused automatically. "Adjusting Focus Manually (FOCUS)" (☞ p. 29)
BRIGHTNESS ADJUST	<ul style="list-style-type: none"> • Overall brightness on the screen can be adjusted. • Use this when recording in a dark or bright location. "Adjusting Brightness" (☞ p. 30)
BACKLIGHT COMP.	<ul style="list-style-type: none"> • Corrects the image when the subject appears dark due to backlight. • Use this when shooting against the light. "Setting Backlight Compensation" (☞ p. 31)
WHITE BALANCE	<ul style="list-style-type: none"> • Overall color on the screen can be adjusted. • Use this when the color on the screen appears differently from the actual color. "Setting White Balance" (☞ p. 32)
TELE MACRO	<ul style="list-style-type: none"> • Use this to take close-up (macro) shots of the subject. "Taking Close-up Shots (TELE MACRO)" (☞ p. 33)

Adjusting Focus Manually (FOCUS)

Set this when the focus is not clear in Intelligent Auto or when manual focusing is desired.

- 1 Select the Manual recording mode.



- If the mode is **i.A.**, Intelligent Auto, tap **i.A.** on the recording screen to display the mode switching screen. Tap **M** to switch the recording mode to Manual.

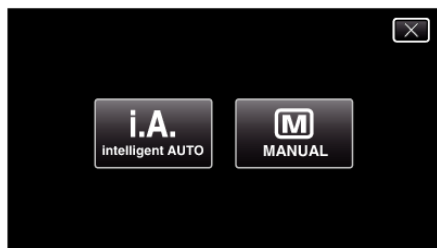

- 2 Tap "MENU".

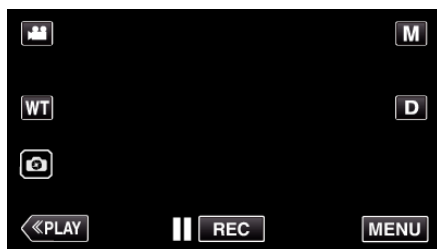

- The top menu appears.

- 3 Tap "RECORD SETTING".



- 4 Tap "FOCUS".

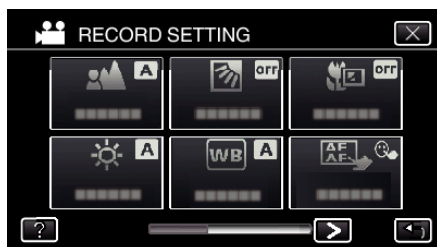

- Tap **X** to exit the menu.
- Tap **↶** to return to the previous screen.

- 5 Tap "MANUAL".

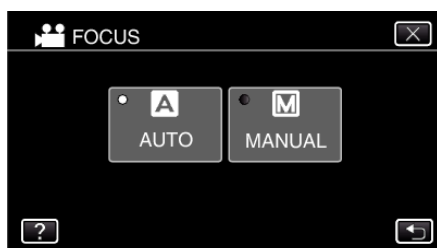

- 6 Adjust the focus.



- Tap ▲ to focus on a distant subject. If ▲ appears blinking, focus cannot be set any further.
- Tap ● to focus on a near subject. If ● appears blinking, focus cannot be set any nearer.

- 7 Tap "SET" to confirm.

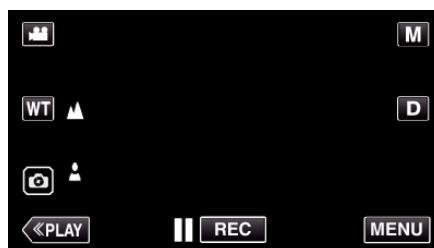

- When focus is confirmed, the focusing frame disappears and ▲ and ● are displayed.

Recording

Adjusting Brightness

You can adjust the brightness to your preferred level.

1 Select the Manual recording mode.

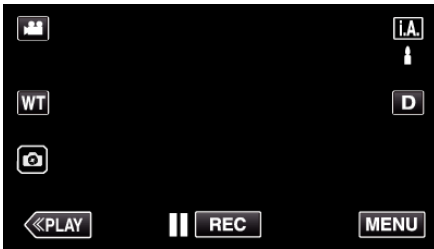

- If the mode is **i.A.**, Intelligent Auto, tap **i.A.** on the recording screen to display the mode switching screen.

Tap **M** to switch the recording mode to Manual.



2 Tap "MENU".

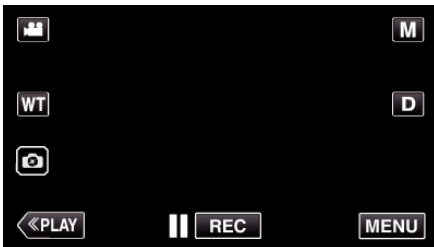

- The top menu appears.

3 Tap "RECORD SETTING".

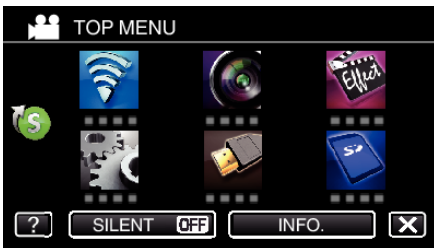

4 Tap "BRIGHTNESS ADJUST".

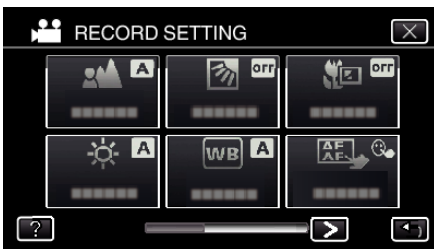

- Tap **X** to exit the menu.
- Tap **↶** to return to the previous screen.

5 Tap "MANUAL".



6 Adjust the brightness value.



- Compensation range: -2.0 to +2.0
- Tap **^** to increase the brightness.
- Tap **v** to decrease the brightness.

7 Tap "SET" to confirm.



Memo :

- Settings can be adjusted separately for videos and still images.

Setting Backlight Compensation

You can correct the image when the subject appears too dark due to backlight.

- 1 Select the Manual recording mode.



- If the mode is **i.A.** Intelligent Auto, tap **i.A.** on the recording screen to display the mode switching screen. Tap **M** to switch the recording mode to Manual.

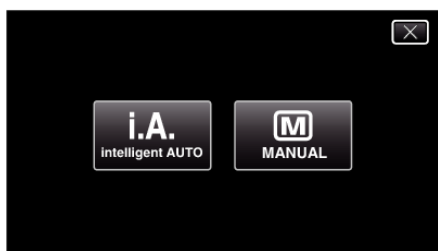

- 2 Tap "MENU".

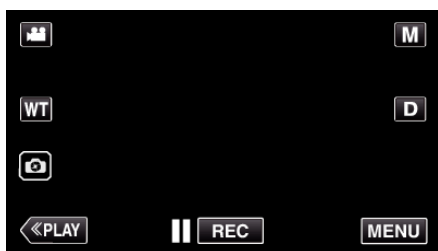

- The top menu appears.

- 3 Tap "RECORD SETTING".



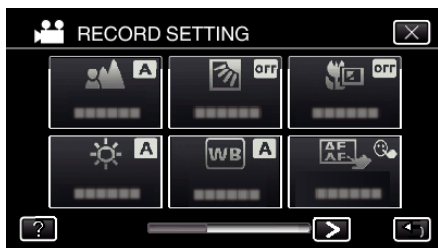

- 4 Tap "BACKLIGHT COMP.".



- Tap X to exit the menu.
- Tap ↶ to return to the previous screen.

- 5 Tap "ON" or "ADVANCE".



- "ADVANCE" is designed to perform more effective backlight compensation. Choose this when the backlight compensation is not adjusted appropriately by "ON".
- After setting, the  icon (Advance: ) appears.

Setting	Details
OFF	Backlight compensation is disabled.
ON	Backlight compensation is enabled.
ADVANCE	Should be selected for a better backlight compensation effect.

Setting White Balance

You can set the color tone to suit the light source.

1 Select the Manual recording mode.

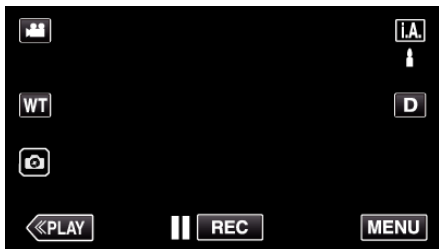

- If the mode is **i.A.**, Intelligent Auto, tap **i.A.** on the recording screen to display the mode switching screen. Tap **M** to switch the recording mode to Manual.

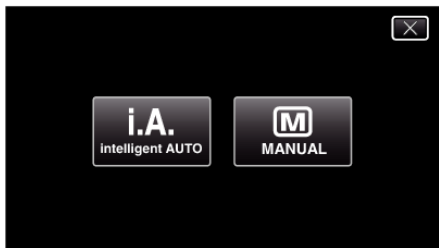

2 Tap "MENU".

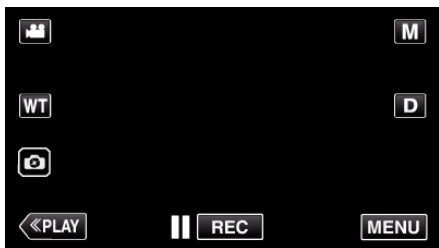

- The top menu appears.

3 Tap "RECORD SETTING".

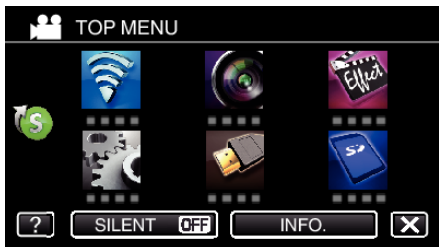

4 Tap "WHITE BALANCE".



- Tap **X** to exit the menu.
- Tap **↩** to return to the previous screen.

5 Select the white balance setting.



- You can either tap the icon, or select the item using the "**<**" "**>**" button and tap "SET".
- The White Balance icon appears on the screen upon completing the setting.

Setting	Details
A AUTO	Adjusts automatically to the natural colors.
MWB	Use this when the problem of unnatural colors is not resolved.
FINE	Set this when shooting outdoors on a sunny day.
CLOUD	Set this when shooting on a cloudy day or inside a shade.
HALOGEN	Set this when shooting under illumination such as a video light.
MARINE:BLUE	Set this when shooting in deep waters (water appears blue).
MARINE:GREEN	Set this when shooting in shallow waters (water appears green).

Using MWB

- 1 Point the cursor to "MWB" using the "**<**" "**>**" button.
- 2 Hold a sheet of plain white paper in front of the lens so that the white paper fills the screen, tap and hold the "SET" button.
- 3 **MWB** blinks, release your finger after the setting screen disappears.
 - You can also tap and hold the "MWB" icon to perform the setting.

Memo :

- The setting will not change if "MWB" is being tapped too fast (less than 1 second).

Taking Close-up Shots (TELE MACRO)

You can take close-up shots of an object using the tele macro function.



*The image is only an impression.

- 1 Select the Manual recording mode.

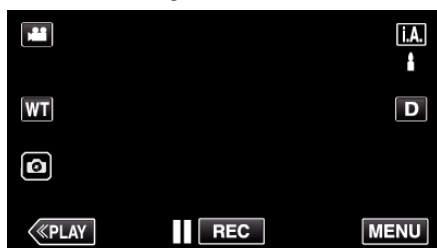

- If the mode is **i.A.** Intelligent Auto, tap **i.A.** on the recording screen to display the mode switching screen. Tap **M** to switch the recording mode to Manual.

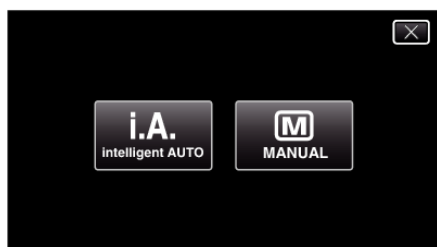

- 2 Tap "MENU".

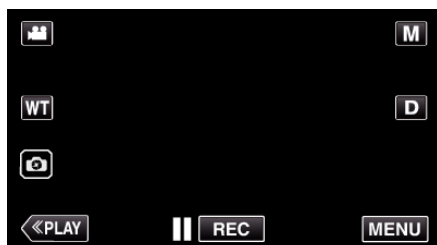

- The top menu appears.

- 3 Tap "RECORD SETTING".

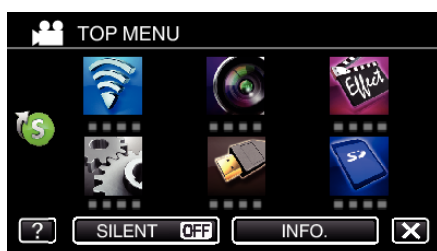



- 4 Tap "TELE MACRO".

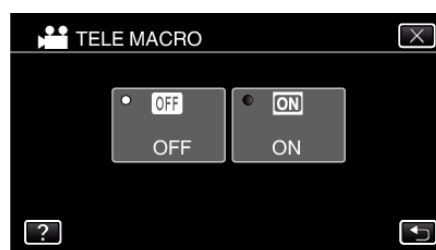

- Tap **X** to exit the menu.
- Tap **↶** to return to the previous screen.

- 5 Tap "ON".



- After setting, the tele macro icon  appears.

Setting	Details
OFF	Enables close-up shots up to 1 m at the telephoto (T) end. Enables close-up shots up to 5 cm at the wide angle (W) end.
ON	Enables close-up shots up to 60 cm at the telephoto (T) end. Enables close-up shots up to 5 cm at the wide angle (W) end.

Caution :

- When you are not taking close-up shots, set "TELE MACRO" to "OFF". Otherwise, the image may be blur.

Shooting under Water

Perform the following settings to shoot underwater.

Setting the White Balance to Underwater Mode

Corrects the color when shooting underwater to record more natural images. Select from the following two settings depending on the color of the water at the shooting location.

- 1 Select the Manual recording mode.

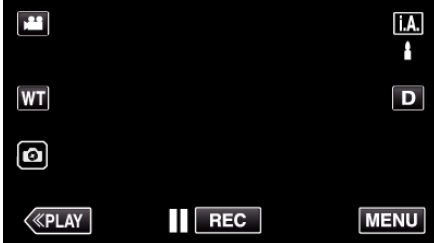

- If the mode is **i.A.**, Intelligent Auto, tap **i.A.** on the recording screen to display the mode switching screen. Tap **M** to switch the recording mode to Manual.

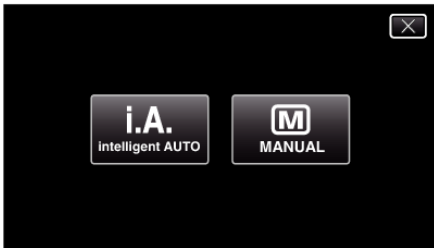

- 2 Tap "MENU".

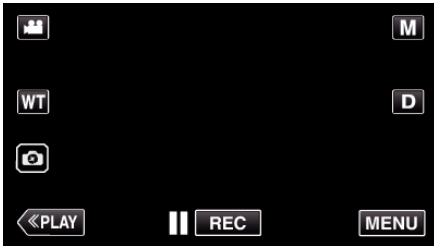

- The top menu appears.

- 3 Tap "RECORD SETTING".

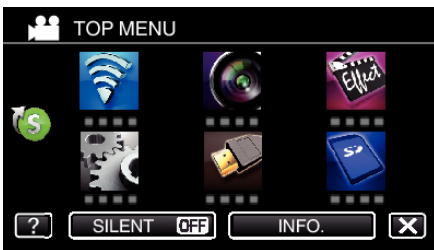

- 4 Tap "WHITE BALANCE".



- 5 Tap or .



Setting	Details
MARINE:BLUE	Set this when shooting in deep waters (water appears blue).
MARINE:GREEN	Set this when shooting in shallow waters (water appears green).

Memo :

- You may not necessarily achieve the correction effect as expected.
- It is recommended to conduct a trial recording in advance.

Locking the Screen

- 1 Tap "MENU".

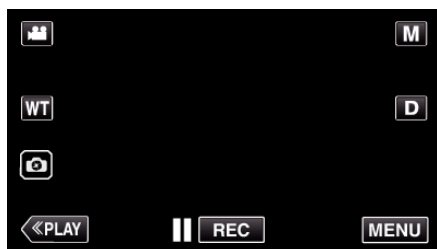

- The top menu appears.

- 2 Tap "RECORD SETTING".



- 3 Tap > on the lower right of the screen.

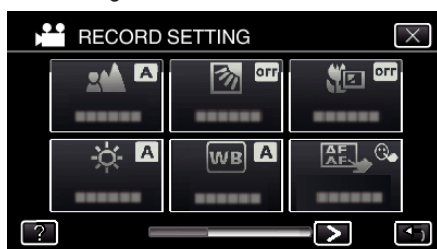

- 4 Tap "SCREEN LOCK".



■ To cancel "SCREEN LOCK"

Tap the  button.



Memo :

- Once "SCREEN LOCK" is set, only the  button on the touch screen can be operated.
- The START/STOP (recording) button and the zoom lever can be used while the screen is locked.
- "SCREEN LOCK" cannot be set for the following cases:
 - during recording
 - when "TIME-LAPSE RECORDING", "RECORDING EFFECT" or "DATE/TIME RECORDING" has been set

■ When the LCD monitor closes due to water pressure during recording.

Opening the LCD screen immediately will prevent the power from turning off and allows you to continue recording.

Caution :

- Before using the camera underwater, read "Before Using Underwater or under Low Temperature" (p. 8) carefully. Improper usage resulting in water submersion will damage the device and cause injury.
- Ensure that the terminal cover is closed tightly before using underwater or on the beach.
"Opening the Terminal Cover (SD Card Cover)" (p. 6)

Recording with Effects

You can add and record various effects to videos or still images. Once setting is done, you can easily record images that are suitable for each image.

Type of Effect	Description of Effect
GRAINY MONOCHROME	Captures film-like monochrome images by increasing the contrast of mid-level brightness and emphasizing the rough grainy feel on the image. "Recording Images Like an Old Black and White Photo (GRAINY MONOCHROME)" (p. 36)
FOOD	Captures food images such that the food looks appetizing even under fluorescent lighting in homes by changing the colors to warm-colors and deepening the colors. "Recording Food Images (FOOD)" (p. 37)
BABY	"Recording Images of a Baby (BABY)" (p. 38)

Caution :

- Depending on the shooting environment and subject, you may not achieve the shooting effect as intended.

Recording Images Like an Old Black and White Photo (GRAINY MONOCHROME)

You can record images with a grainy black and white photo feel. *The image is only an impression.

- Open the LCD monitor.

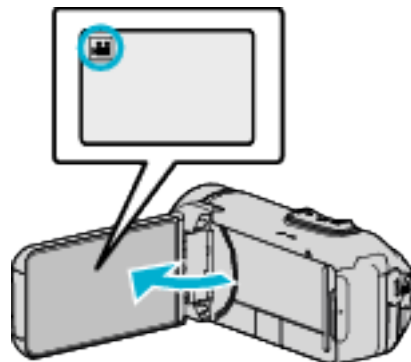

- Set the recording mode to either video or still image.
- To switch the mode between video and still image, tap or on the recording screen to display the mode switching screen. Tap or to switch the mode to video or still image respectively.

- Tap "MENU".

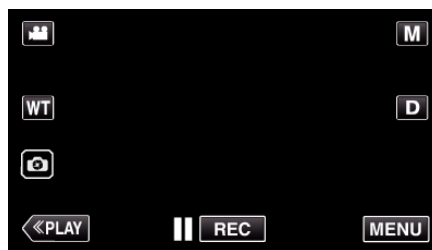

- The top menu appears.

- Tap "SPECIAL RECORDING".

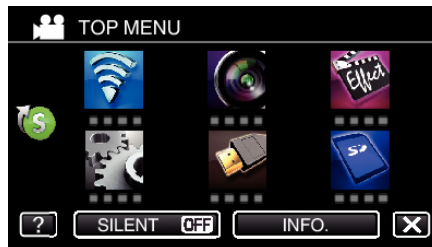

- Tap "RECORDING EFFECT".

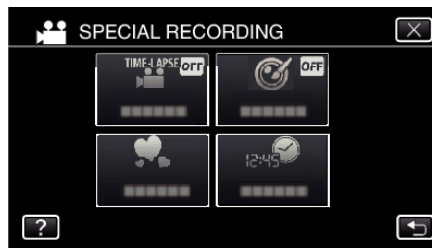

- Tap X to exit the menu.
- Tap ↶ to return to the previous screen.

- Tap "GRAINY MONOCHROME".

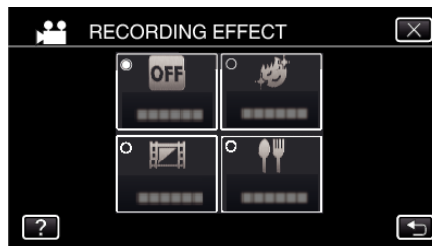

- Tap X to exit the menu.
- Tap ↶ to return to the previous screen.

- 6 Start recording.
- To cancel the setting, repeat the procedure from the beginning and tap "OFF" in Step 5.

Recording Food Images (FOOD)

You can capture images of the food to make the food look appetizing.
*The image is only an impression.

- 1 Open the LCD monitor.

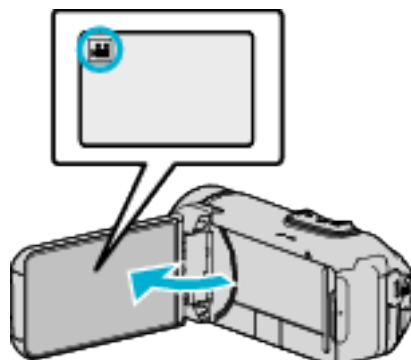

- Set the recording mode to either video or still image.
- To switch the mode between video and still image, tap or on the recording screen to display the mode switching screen. Tap or to switch the mode to video or still image respectively.

- 2 Tap "MENU".

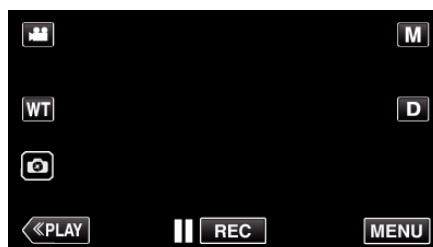

- The top menu appears.

- 3 Tap "SPECIAL RECORDING".

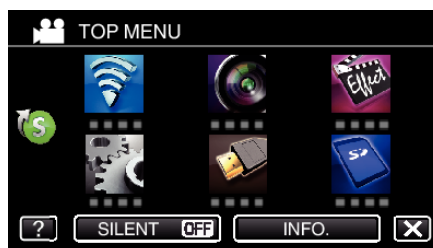

- 4 Tap "RECORDING EFFECT".



- Tap X to exit the menu.
- Tap to return to the previous screen.

- 5 Tap "FOOD".

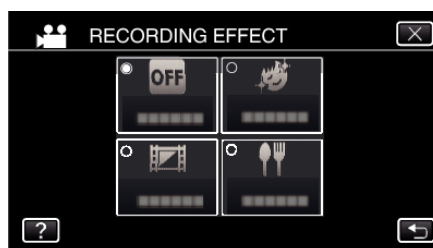

- Tap X to exit the menu.
- Tap to return to the previous screen.

- 6 Start recording.
 - To cancel the setting, repeat the procedure from the beginning and tap "OFF" in Step 5.

Recording Images of a Baby (BABY)

You can capture soft images by enhancing the clarity and brightness of skin color. This effect is suitable for capturing images of a baby.
*The image is only an impression.

- 1 Open the LCD monitor.

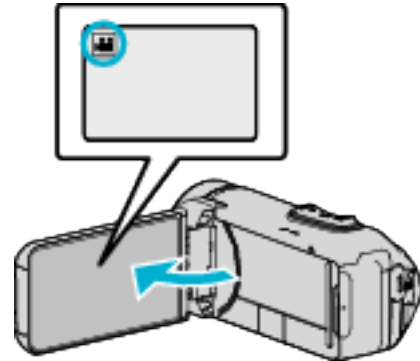

- Set the recording mode to either video or still image.
- To switch the mode between video and still image, tap or on the recording screen to display the mode switching screen. Tap or to switch the mode to video or still image respectively.

- 2 Tap "MENU".

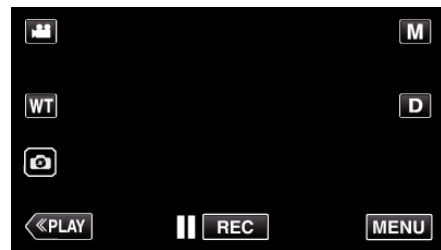

- The top menu appears.

- 3 Tap "SPECIAL RECORDING".



- 4 Tap "RECORDING EFFECT".



- Tap X to exit the menu.
- Tap ↶ to return to the previous screen.

- 5 Tap "BABY".



- Tap X to exit the menu.
- Tap ↶ to return to the previous screen.

- 6 Start recording.
- To cancel the setting, repeat the procedure from the beginning and tap "OFF" in Step 5.

Recording with Animation Effects (ANIMATION EFFECT)

You can add animation effects to video recordings. The animation effects appear when smiles are detected or when the screen is touched.

- 1 Open the LCD monitor.

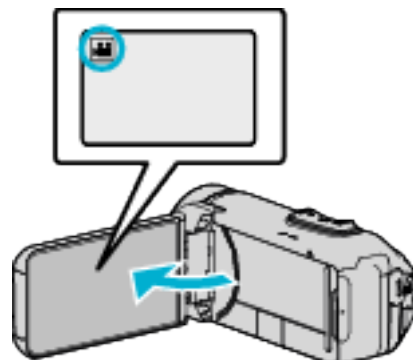

- Set the recording mode to either video or still image.
- To switch the mode between video and still image, tap or on the recording screen to display the mode switching screen. Tap or to switch the mode to video or still image respectively.

- 2 Tap "MENU".



- The top menu appears.

- 3 Tap "SPECIAL RECORDING". (Go to step 4.)
Alternatively, tap "ANIMATION EFFECT" in the shortcut menu. (Go to step 5.)

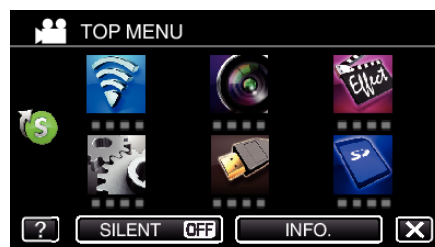

- 4 Tap "ANIMATION EFFECT".

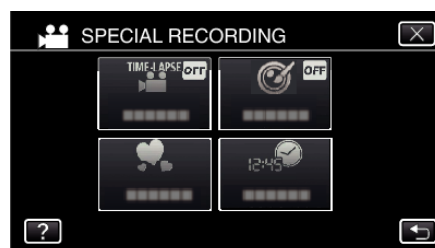





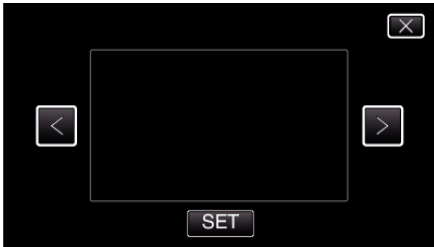

- Tap X to exit the menu.
- Tap ↶ to return to the previous screen.

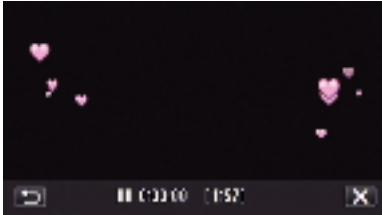
- 5 Select a desired effect and tap "SET".

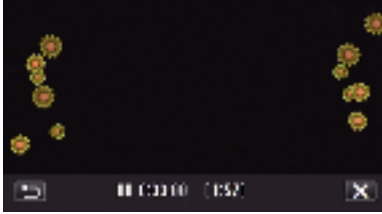

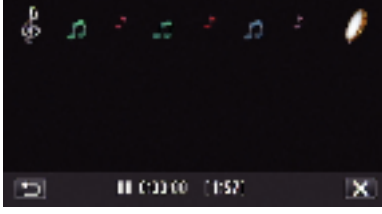
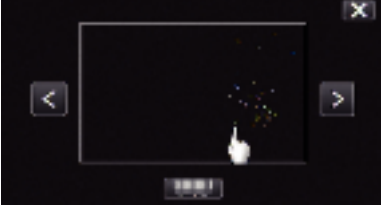
- Tap < or > to change the effect.
- Press the START/STOP button the camera to start recording.
Press again to stop.
- To select another effect again after tapping "SET", tap ↩.
- Tap X to exit "ANIMATION EFFECT".
(To perform operations other than recording, tap X to cancel the "ANIMATION EFFECT" first.)

During Setting	After Setting	Note
		<p>Animation (effect) appears when smiles are detected.</p>
		<p>Animation (effect) appears when smiles are detected.</p>
		<p>Animation (effect) appears when smiles are detected.</p>
		<p>Animation (effect) appears when the screen is touched.</p>

Capturing Subjects Clearly (TOUCH PRIORITY AE/AF)

“TOUCH PRIORITY AE/AF” is a function that adjusts focus and brightness based on a tapped position. This function is available for both videos and still images.

1 Open the LCD monitor.

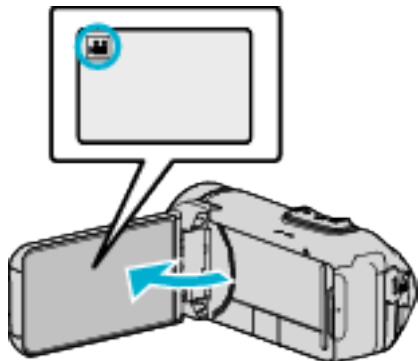

- Set the recording mode to either video or still image.
- To switch the mode between video and still image, tap or on the recording screen to display the mode switching screen. Tap or to switch the mode to video or still image respectively.

2 Tap “MENU”.

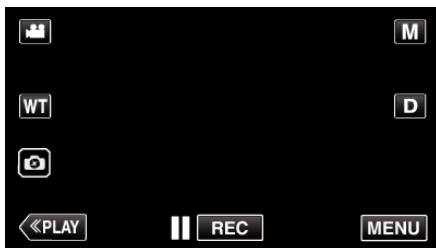

- The top menu appears.

3 Tap “RECORD SETTING”.



4 Tap “TOUCH PRIORITY AE/AF”.

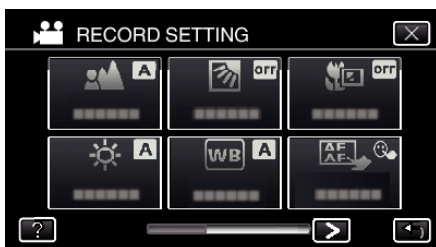

- Tap X to exit the menu.
- Tap to return to the previous screen.

5 Tap the desired setting.



- Focus and brightness will be adjusted automatically based on the tapped position (face/color/area). A blue frame appears around the selected subject (face/color), while a white frame appears around the selected area.
- To reset, tap the desired position (face/color/area) again.
- To cancel “FACE TRACKING” or “COLOR TRACKING”, tap the blue frame.
- To cancel “AREA SELECT”, tap the white frame.

Setting	Details
OFF	Deactivates the function.
FACE TRACKING	appears on the screen. Recording is performed while tracking and automatically adjusting the tapped face (subject) with appropriate focus and brightness. In addition, a blue frame appears around the tapped face (subject). (When the face of a person is registered, it becomes the main subject and the blue frame appears even without specific selection.)
COLOR TRACKING	appears on the screen. Recording is performed while tracking and automatically adjusting the tapped color (subject) with appropriate focus. In addition, a blue frame appears around the tapped color (subject).
AREA SELECT	appears on the screen. Recording is performed while automatically adjusting the tapped area (fixed position) with appropriate focus and brightness. In addition, a white frame appears around the tapped area. AREA SELECT in TOUCH PRIORITY AE/AF is only available within the optical zoom range. (unavailable when digital zoom is being used)

Memo :

- When “TOUCH PRIORITY AE/AF” is set, “FOCUS” will be set to “AUTO” automatically.
- Tap the selected position (face/color/area) again to cancel the setting. (Setting remains for registered faces.)
- Tap on an unselected position (face/color/area) to reset.
- If the camera loses track of a subject, tap the subject again.
- Settings are canceled when zoom operation is performed. (“AREA SELECT” only)
- When “COLOR TRACKING” is set, the targeted subject (color) may change if similar colors are detected. In this case, tap the subject again. The targeted subject (color) may also be tracked back again if it appears in the center of the screen within a specific time.

Caution :

- Subjects near the sides of the LCD monitor may not respond or be recognized when tapped. In this case, move the subject to the center and tap again.
- “FACE TRACKING” may not work properly depending on the shooting conditions (distance, angle, brightness, etc.) and the subject (direction of face, etc.). It is also particularly difficult to detect faces in backlight.
- “COLOR TRACKING” may not function properly in the following cases:
 - when recording subjects with no contrast
 - when recording subjects that are moving at high speed
 - when recording in a dark place
 - when the surrounding brightness changes
- “AREA SELECT” is not available while the digital zoom is in use.

Reducing Camera Shake

When the image stabilizer is set, camera shake during video recording can be effectively reduced.

- 1 Tap “MENU”.

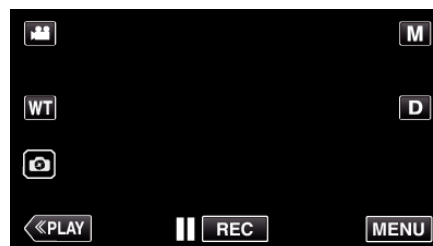

- 2 Tap “RECORD SETTING”.

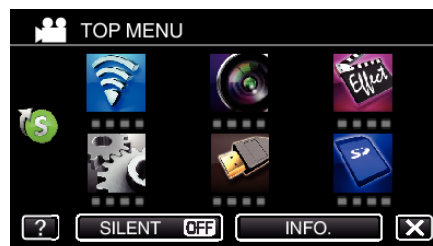

- 3 Tap “OIS”.

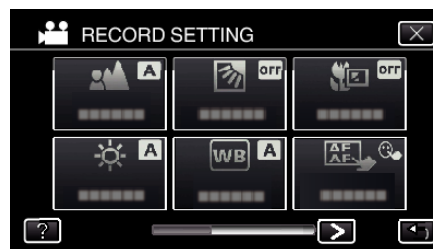

- If the icon is not displayed on the screen, tap “>” to scroll the screen.
- Tap X to exit the menu.
- Tap ↶ to return to the previous screen.

- 4 Tap the desired setting.

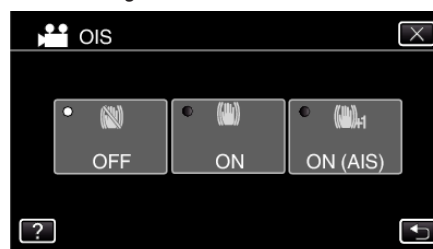

Setting	Details
OFF	Deactivates image stabilizer.
ON	Reduces camera shake under normal shooting conditions.
ON (AIS)	Reduces camera shake more effectively when shooting bright scenes on the wide angle end. Only on the wide angle end (approx. 5x).

Memo :

- It is recommended to set the image stabilizer to “OFF” when shooting a subject of little movement with the unit on a tripod.
- Complete stabilization may not be possible if camera shake is excessive.
- This setting is effective for video recording only.
- Using the image stabilizer will narrow the angle of view.

Recording at Intervals (TIME-LAPSE RECORDING)

This function enables the changes of a scene that occur slowly over a long period to be shown within a short time by taking frames of it at a certain interval.

This is useful for making observations such as the opening of a flower bud.

1 Open the LCD monitor.

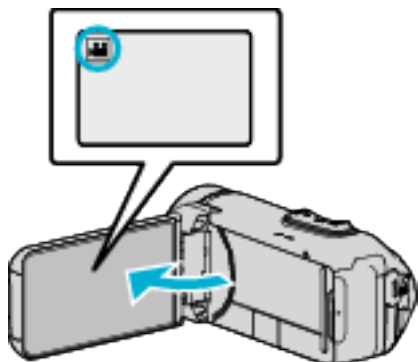

- Check if the recording mode is .
- If the mode is still image, tap on the recording screen to display the mode switching screen. Tap to switch the mode to video.

2 Tap "MENU".

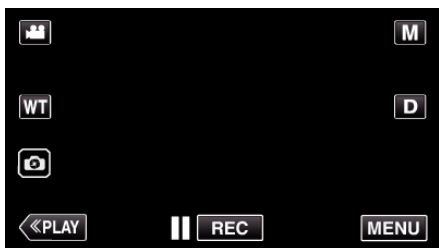

- The top menu appears.

3 Tap "SPECIAL RECORDING".

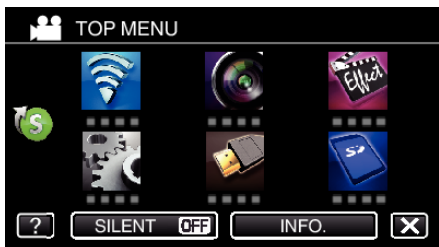

4 Tap "TIME-LAPSE RECORDING".



- Tap to exit the menu.
- Tap to return to the previous screen.

5 Tap to select a recording interval (1 to 80 seconds).

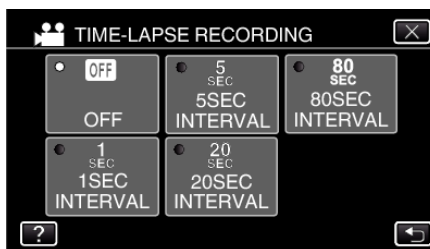

- The greater the number of seconds, the longer the recording interval.
- Tap to exit the menu.
- Tap to return to the previous screen.

6 Start recording.

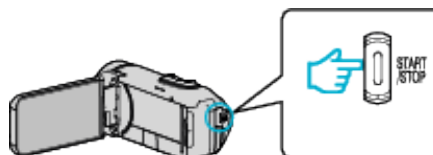

- A frame is taken at intervals of the selected period.
- When the recording interval is set to "20SEC INTERVAL" or higher, this unit switches to the power-saving mode between recordings. At the next point to record, the power-saving mode will be turned off and recording will start automatically.
- Settings of Time-Lapse recording are not saved when the power is turned off.

Indications During Time-Lapse Recording



	Display	Description
①	Recording interval	Displays the recording interval that is set.
②	Recorded Time	Displays the actual recorded time of the video. Recorded time increases in units of frames.
③	Actual Elapsed Time	Displays the actual elapsed time after recording starts.
④	Remaining Recording Time	Remaining time left to record with the currently selected video quality.

Time-Lapse Setting

The greater the number of seconds, the longer the recording interval.

Setting	Details
OFF	Deactivates the function.
1SEC INTERVAL	Takes a frame at 1-second intervals. Recorded videos will be played back at 30 times speed.
5SEC INTERVAL	Takes a frame at 5-second intervals. Recorded videos will be played back at 150 times speed.
20SEC INTERVAL	Takes a frame at 20-second intervals. Recorded videos will be played back at 600 times speed.
80SEC INTERVAL	Takes a frame at 80-second intervals. Recorded videos will be played back at 2 400 times speed.

Caution :

- During the time-lapse recording, video quality is set to XP mode.
- Audio cannot be recorded during time-lapse recording.
- When recording is stopped with the recorded time less than "0:00:00:14", the video will not be saved.
- Zooming, simultaneous still image recording, and image stabilizer are not available in time-lapse recording.
- Seamless recording is disabled in time-lapse recording.
- When Time-Lapse recording is set, you cannot record still images.

Memo :

- Settings of time-lapse recording are reset when the power is turned off. To start time-lapse recording again, it is necessary to make the selection once more.
- Recording stops automatically 99 hours after it is started.
- Make use of a tripod and AC adapter for time-lapse recordings with long intervals.
It is also recommended to fix the focus and white balance manually.

"Tripod Mounting" (p. 19)

Taking Group Shots (Self-timer)

The 10-second self-timer is a convenient function for taking group photos. The 2-second self-timer is useful for preventing camera shake caused by pressing the shutter button.

Memo :

- This function is available in still image recording mode.
- When shooting a photo using the self-timer function, use of a tripod is recommended.

"Tripod Mounting" (p. 19)

Using the 2-/10-second Self-timer

- 1 Open the LCD monitor.

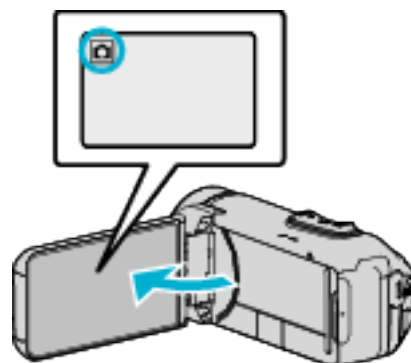

- Check if the recording mode is .
- If the mode is video, tap on the recording screen to display the mode switching screen.
Tap to switch the mode to still image.

- 2 Tap "MENU".

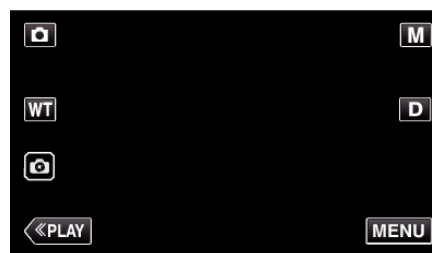

- The top menu appears.

- 3 Tap "RECORD SETTING".

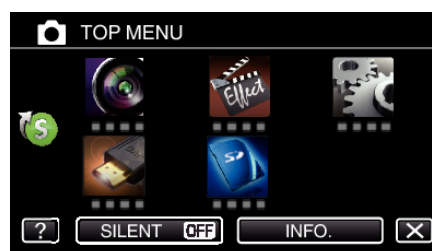

4 Tap "SELF-TIMER".



- If the icon is not displayed on the screen, tap ">" to scroll the screen.
- Tap X to exit the menu.
- Tap ↶ to return to the previous screen.

5 Tap "2SEC" or "10SEC".

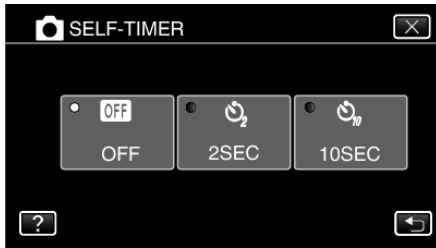

6 Take a still image.

- A timer appears and countdown to shooting starts.
- To stop the self-timer, press the START/STOP button again.

Memo :

- The START/STOP button on this unit cannot be used to adjust the focus in advance. To adjust the focus in advance, press and hold the button on the touch screen until the focus is adjusted.

"Start recording after adjusting the focus" (p. 25)

- While the countdown timer is displayed, the buttons cannot be used as they are not displayed on the screen.

Recording Videos with Date and Time

You can record videos together with the date and time. Set this when you want to save the file with date and time display. (The date and time cannot be deleted after recording.)

1 Open the LCD monitor.

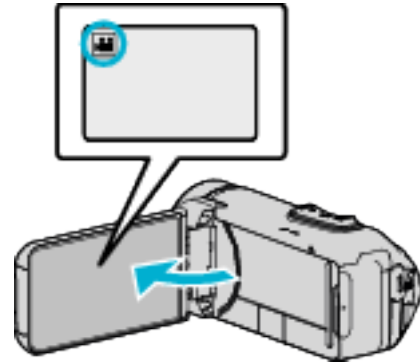

- Check if the recording mode is .
- If the mode is still image, tap on the recording screen to display the mode switching screen. Tap to switch the mode to video.

2 Tap "MENU".

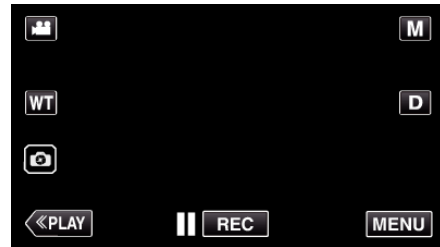

- The top menu appears.

3 Tap "SPECIAL RECORDING".



4 Tap "DATE/TIME RECORDING".



- Tap X to exit the menu.
- Tap ↶ to return to the previous screen.

- 5 Select the type of clock with < or >, and tap "SET".



- When "SET" is tapped, the precaution for date/time recording appears.
 - Tap X to exit the menu.
- 6 Tap the display position with your finger and drag your finger to adjust.

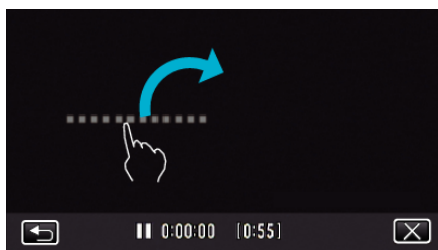

- Move the date and time display while touching it with your finger and tracing it on a screen.
- 7 Press the START/STOP button to start recording.

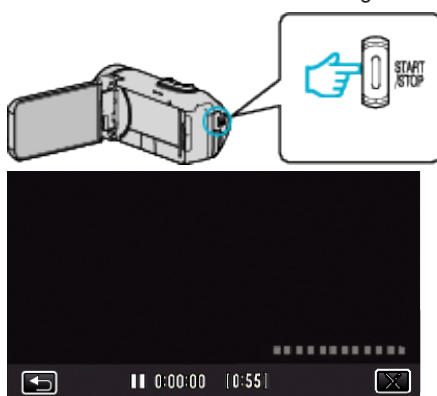

- Press the START/STOP button again to stop recording.
- Tap ⏪ to return to the screen for selecting the types of clock.
- Tap X to exit "DATE/TIME RECORDING".
(To perform operations other than recording, tap X to cancel the "DATE/TIME RECORDING" first.)

Caution : _____

- The date and time cannot be deleted after recording.

Checking the Remaining Recording Time

Display the remaining battery power and the remaining recording time.

Memo : _____

- The remaining battery power and the remaining recording time are estimates.
- The remaining recording time is displayed only during video mode.
- The remaining recording time is displayed for the recording media that is currently selected.

- 1 Open the LCD monitor.

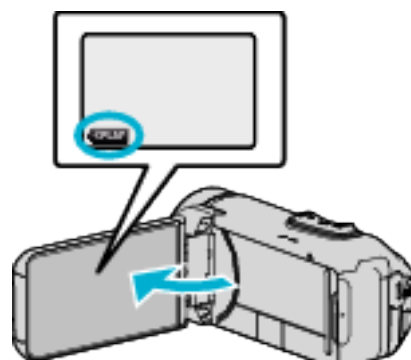

- Check that the camera is set to the recording mode. If the camera is in the playback mode, click «PLAY to switch to recording mode.

- 2 Tap "MENU".



- The top menu appears.

- 3 Tap "INFO.".

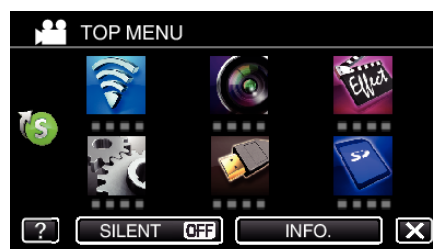

- 4 Display the remaining recording time.

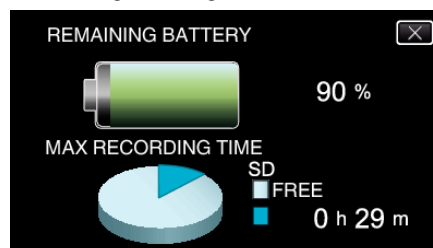

- The remaining recording time is displayed only in the video recording mode.
- The remaining recording time is displayed for the recording media that is currently selected.
- ⚡ is displayed instead of the remaining battery power when the AC adapter is connected.
- To exit the display, tap X.

Recording

Approximate Video Recording Time

Picture quality	Built-in memory	
	8GB (GZ-RX110)	16GB (GZ-RX120)
UXP	35 m	1 h 10 m
XP	50 m	1 h 50 m
EP	3 h	6 h 30 m
50p	30 m	1 h 10 m

Picture quality	SDHC/SDXC card					
	4GB	8GB	16GB	32GB	64GB	128GB
UXP	20 m	40 m	1 h 20 m	2 h 40 m	5 h 40 m	11 h 30 m
XP	30 m	1 h	1 h 50 m	3 h 50 m	8 h 10 m	16 h 20 m
EP	1 h 40 m	3 h 30 m	7 h	14 h	28 h 50 m	57 h 50 m
50p	15 m	35 m	1 h 10 m	2 h 30 m	5 h	10 h 10 m

- The recordable time is only a guide. The actual recording time may be longer or shorter than the time indicated above.

Approximate Number of Still Images (Unit: Number of Shots)

Image size	Built-in memory		SDHC/SDXC card				
	8GB (GZ-RX110)	16GB (GZ-RX120)	4GB	8GB	16GB	32GB	64GB
3680x2760(10.15M)(4:3)	1100	2400	600	1300	2500	5100	9999
1920x1080(2M)(16:9)	5600	9999	3100	6400	9999	9999	9999
1440x1080(1.5M)(4:3)	7400	9999	4200	8400	9999	9999	9999
640x480(0.3M)(4:3)	9999	9999	9999	9999	9999	9999	9999

- Still images that are captured during video recording or video playback are saved at a size of 1920 x 1080.

Approximate Duration of Built-in Battery

Actual recording time	Continuous recording time (Maximum Recording Time)
2 h 25 m	4 h 30 m

- The above are values when "LIGHT" is set to "OFF", "MONITOR BRIGHTNESS" is set to "3" (standard), and "SYSTEM SELECT" is set to "50".
- The actual recording time is an estimate in case that such operations as zooming is used or recording is stopped repeatedly. It may be shorter in the actual usage.
- Recording time may differ depending on the shooting environment and usage.
- When the recording time becomes extremely short even when the battery is fully charged, the battery needs to be replaced. For details on replacing the built-in battery (subject to a fee), consult the nearest JVC service center.

Playing Back Videos

The followings are the types of playback that can be performed by this unit.

Item	Description
Normal Playback	Plays back the recorded videos.
DIGEST PLAYBACK	From the recorded video, scenes with a smile detected and scenes with a person whose face is registered are extracted and pieced together for a digest playback. When "AUTO" is selected, recorded video is digested in the pre-set length of time. Start playback from "DIGEST PLAYBACK" in the "PLAYBACK SETTING" menu.
PLAYBACK PLAYLIST	Plays back the playlists registered in Digest Playback. Start playback from "PLAYBACK PLAYLIST" in the "PLAYBACK SETTING" menu.
PLAYBACK OTHER FILE	Videos with defective management information can be played back. Start playback from "PLAYBACK OTHER FILE" in the "PLAYBACK SETTING" menu.

Switching to the video playback screen

1 Open the LCD monitor.

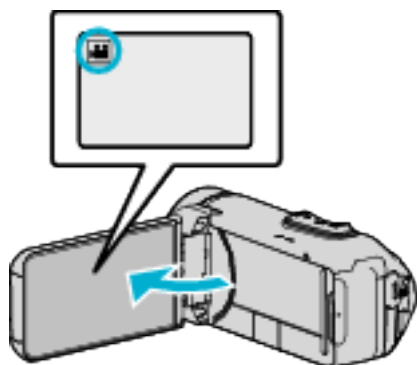

- Check if the recording mode is .
- If the mode is still image, tap on the recording screen to display the mode switching screen. Tap to switch the mode to video.

2 Tap <<PLAY to select the playback mode.

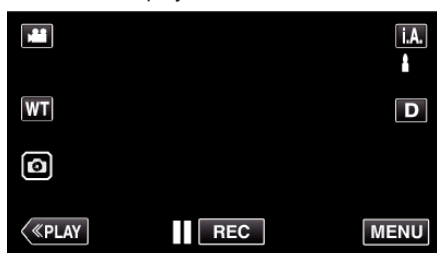

3 The video playback screen is displayed.



Caution :

- Make a backup of important recorded data. It is recommended to copy your important recorded data to a DVD or other recording media for storage.
- This unit is a microcomputer-controlled device. Electrostatic discharge, external noise and interference (from a TV, a radio, etc.) might prevent it from functioning properly. In such a case, close the monitor screen to turn off the power and remove the AC adapter, then press the Reset button to reset this unit.
"Resetting this Unit" (p. 7)
- Disclaimer
 - We shall not be held responsible for loss of recorded contents when recording videos/audio or playback cannot be operated due to malfunctions in this unit, provided parts, or SD card.
 - Once deleted, recorded contents (data), including data loss due to malfunctions in this unit, cannot be restored. Please be forewarned.
 - JVC will not be responsible for any lost data.
 - In order for quality improvement, defective recording medium is subject to be analyzed. Therefore, it may not be returned.

Playback

Normal Playback

Plays back the recorded videos.

- 1 Open the LCD monitor.

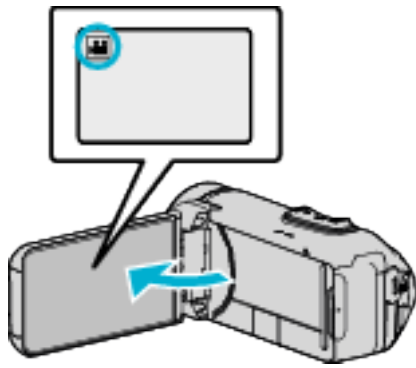

- Check if the recording mode is .
- If the mode is , tap on the recording screen to display the mode switching screen. Tap to switch the mode to video.

- 2 Tap **PLAY** to select the playback mode.

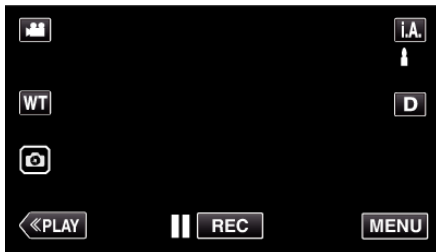

- 3 Tap the file (image).



- Tap to select the media for playback and change the index screen (thumbnail display).
- appears on the last image played back.
- Lines in different colors are displayed under the thumbnail display to distinguish the recording date.
- Images recorded in 50p mode and 50i mode are displayed on the index screen separately.
- To view the images recorded in 50p mode, set "SYSTEM SELECT" in the video recording menu to "50p" before selecting the playback mode. In cases such as during Digest Playback or when playing back/editing a playlist, set "SYSTEM SELECT" in the same way before operating.
- To view the images recorded in 50i mode, set "SYSTEM SELECT" in the video recording menu to "50i" before selecting the playback mode. In cases such as during Digest Playback or when playing back/editing a playlist, set "SYSTEM SELECT" in the same way before operating.

- 4 Playback starts.

- Tap to pause.
- Tap to return to the index screen.

Caution :

- While this unit may be used with the LCD monitor reversed and closed, the temperature rises more easily. Do not use this unit with the LCD monitor reversed and closed for long periods of time, or in places exposed to direct sunlight or high temperatures.
- The power may turn off to protect the circuit if the temperature of this unit rises too much.

Operation Buttons for Video Playback

During Index Screen Display

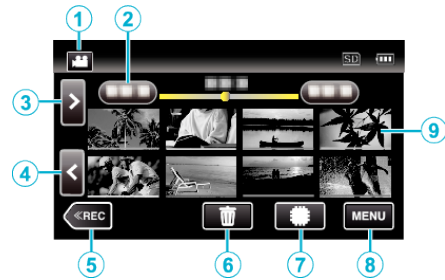

	Display	Description
①	Video/Still Image Mode /	Switches between video and still image modes. Switches between video mode (50i/50p) and still image mode.
②	Date	Moves to the previous/next date
③	>	Displays the next index screen (thumbnail display) • You can perform the same operation with the zoom lever.
④	<	Displays the previous index screen (thumbnail display) • You can perform the same operation with the zoom lever.
⑤	◀REC	Switches to the recording mode.
⑥		Displays the index screen (thumbnail display) to perform deletion
⑦		Switches between the memories in which images are recorded (built-in memory/ SD card)
⑧	MENU	Displays the menu screen
⑨	Thumbnail (File)	Tap on thumbnail - Starts playback Drag to right - Scrolls to the right to show the previous index screen (thumbnail display) Drag to left - Scrolls to the left to show the next index screen (thumbnail display) Images with the same underlined color indicates the same recording date.

During Video Playback

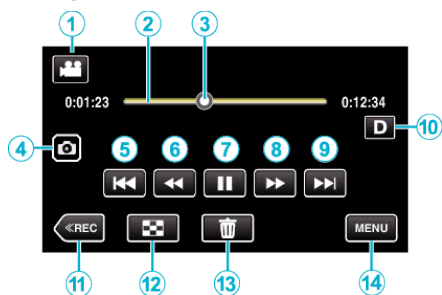

- When this unit is not operated, the operation buttons on the touch screen disappear automatically. Tap on the screen to display the operation buttons again.

	Display	Description
①	Video/Still Image Mode 	Switches between video and still image modes.
②	Timeline Bar	Tap on a random position - Moves to the tapped position Drag playback point to the left or right - Starts playback from the new position Tap on a random position - Moves to the tapped position
③	Pointer	Displays the current estimated playback position within the scene
④	Still Image Recording Button	Saves one scene of the video being played back as a still image. • Displayed while playback is paused.
⑤		Returns to the beginning of the scene Returns to the previous scene if tapped at the beginning of a scene. • Allows the same functions as the zoom lever to be performed while pausing playback.
⑥	(during playback)	Reverse search (speed increases with each tap)
	(during pause mode)	Reverse slow-motion / Press and hold to start reverse slow playback
⑦		Starts playback
		Pause
⑧	(during playback)	Forward search (speed increases with each tap)
	(during pause mode)	Forward slow-motion / Press and hold to start slow playback
⑨		Advances to the next scene
⑩	Display Button	Switches the display between full (D?) and simple (D) with every tap of the button. • Simple display: Some displays disappear automatically when the screen is not operated. • Full display: Displays everything. The display button changes from D to D? . • When the power is turned off, the display setting will revert to simple display (D).
⑪		Switches to the recording mode.
⑫		Stop (returns to index screen)
⑬		Deletes the currently displayed video.

⑭	MENU	Displays the menu screen
---	------	--------------------------

Memo :

- Tap or drag on the operation area of the touch screen.
- The recording date and time can be displayed on the screen during playback.

(p. 158)

Adjusting the Volume of Videos

You can use the zoom/volume lever to control the volume.

Turn up the volume

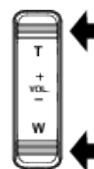

Turn down the volume



Checking the Recording Date and Other Information

You can see the recording information of the recorded videos.

- 1 Open the LCD monitor.

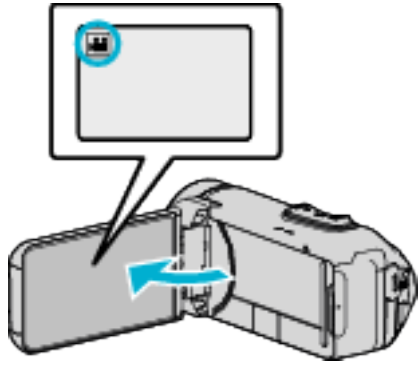

- Tap or to select the video or still image mode.

- 2 Tap **<<PLAY** to select the playback mode.

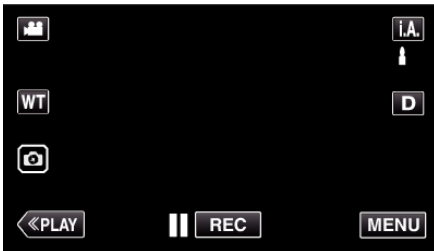

- 3 Tap on the file to start playback.



- 4 Tap "MENU".

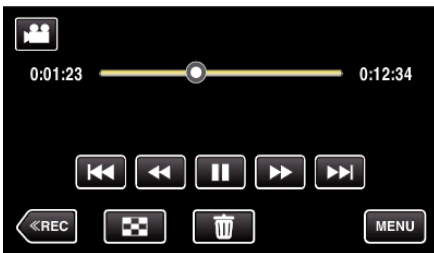

- 5 Tap "INFO.".



- Tap X to exit the menu.

You can display the recording date and duration of the selected file.



DIGEST PLAYBACK

You can play back a digest of recorded videos (Digest Playback). This is useful for checking the content of videos quickly.

1 Open the LCD monitor.

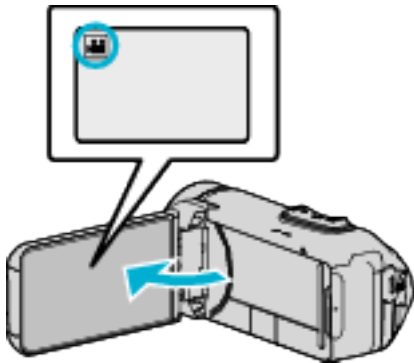

- Check if the recording mode is .
- If the mode is still image, tap on the recording screen to display the mode switching screen. Tap to switch the mode to video.

2 Tap **PLAY** to select the playback mode.

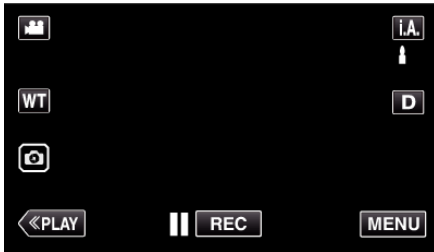

3 Tap "MENU".



4 Tap "PLAYBACK SETTING".



5 Tap "DIGEST PLAYBACK".

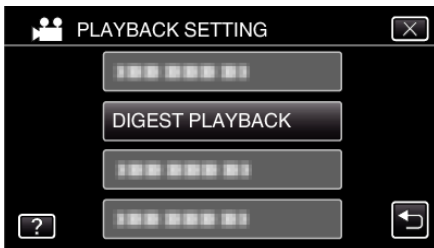

6 Tap to select a date for Digest Playback.



- After selecting a date, tap "NEXT".
- When "ALL" is tapped, Digest Playback will be performed for all the dates.
- Tap **X** to exit the menu.
- Tap to return to the previous screen.

7 Select the Digest Playback time

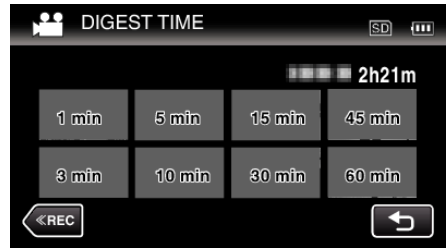

- Select the Digest Playback time in minutes (min).
- The time display of Digest Playback varies according to the recording time.
- When it takes time (more than 2 seconds) for "DIGEST PLAYBACK" to start after selecting Digest Playback time, a progress status will be displayed.
- The Digest Playback time is only a guide.

8 Digest Playback starts.

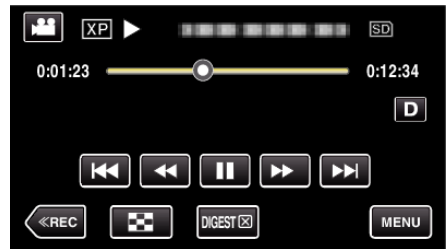

- Tap to pause.
- Tap to return to the index screen.
- Tap "DIGEST X" to return to the normal playback screen.
- Operations During Video Playback
"Operation Buttons for Video Playback" (p. 50)

9 Digest playback stops automatically, or display the next screen by tapping "MENU".

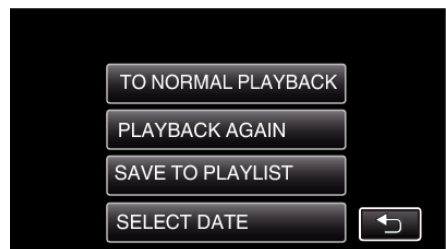

- TO NORMAL PLAYBACK: start normal playback.
- PLAYBACK AGAIN: start the digest playback again.
- SAVE TO PLAYLIST: save the digest playback images to the playlist. ((Digest Playback) icon appears.)
"PLAYBACK PLAYLIST" (p. 54)
- SELECT DATE: return to step 6.

Playback

PLAYBACK PLAYLIST

Plays back the playlists registered in Digest Playback.

- 1 Open the LCD monitor.

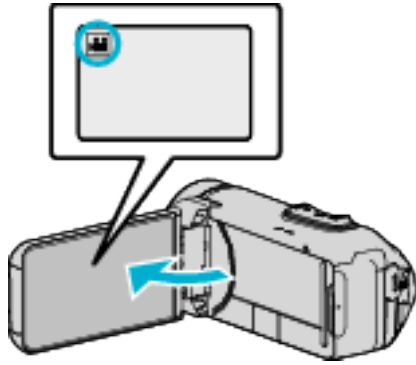

- Check if the recording mode is .
- If the mode is still image, tap on the recording screen to display the mode switching screen.
Tap to switch the mode to video.

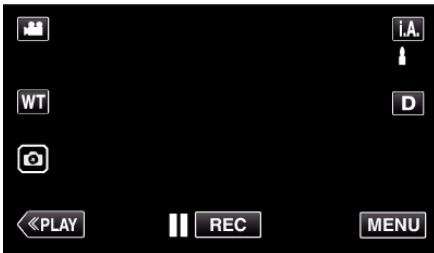

- 2 Tap "MENU".



- 3 Tap "PLAYBACK SETTING".

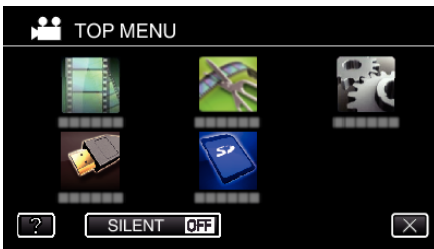

- 4 Tap "PLAYBACK PLAYLIST".

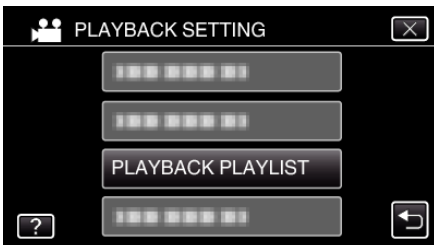

- 5 Tap to select a playlist.



- Playback of the playlist starts.
"Operation Buttons for Video Playback" (p. 50)
- Tapping during playback brings you back to the index screen of Playback Playlist.
- Playlists with a (Digest Playback) icon are the playlists created during Digest Playback.

PLAYBACK OTHER FILE

The management information of a video may be damaged if recording is not performed correctly, such as turning off the power in the middle of recording. You can perform the following operations to play back the videos with defective management information.

1 Open the LCD monitor.

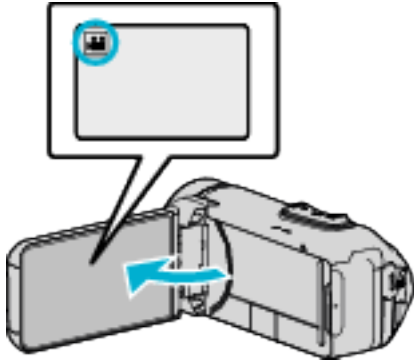

- Check if the recording mode is .
- If the mode is still image, tap on the recording screen to display the mode switching screen. Tap to switch the mode to video.

2 Tap **PLAY** to select the playback mode.

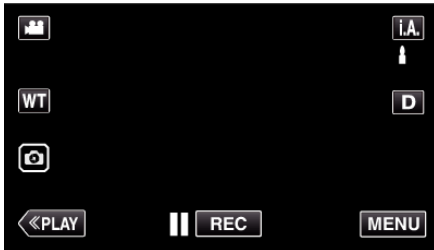

3 Tap "MENU".



4 Tap "PLAYBACK SETTING".

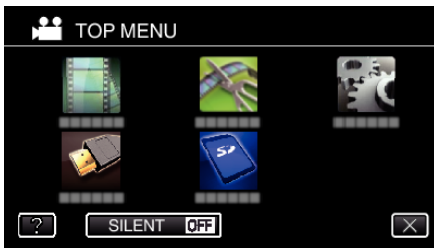

5 Tap "PLAYBACK OTHER FILE".

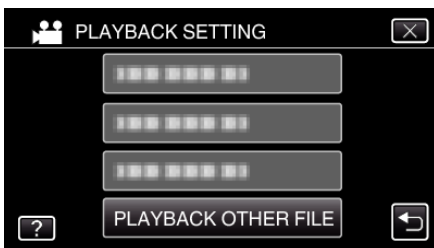

6 Tap on the file to start playback.



"Operation Buttons for Video Playback" (p. 50)

- Tap "X" to return to the usual index screen.

Memo :

- An MTS file is created in the EXTMOV folder when management information is corrupted.
- Depending on the condition of the damaged file, playback might fail or may not run smoothly.

Playing Back Still Images

You can select and play back the recorded still images from an index screen (thumbnail display).

- 1 Open the LCD monitor.

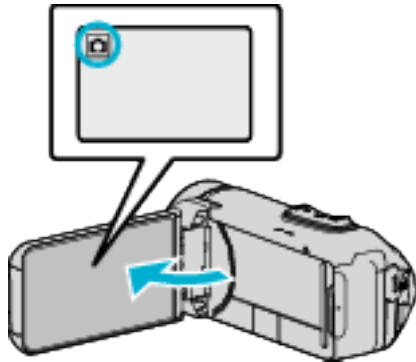

- Check if the recording mode is .
- If the mode is video, tap on the recording screen to display the mode switching screen. Tap to switch the mode to still image.

- 2 Tap **<<PLAY** to select the playback mode.

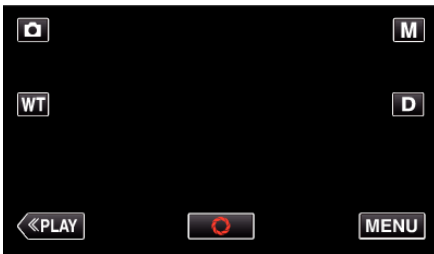

- 3 Tap on the file to start playback.



- Tap to select the media for playback and change the index screen (thumbnail display).
- Tap to return to the index screen.
- appears on the last image played back.
- Lines in different colors are displayed under the thumbnail display to distinguish the recording date.

Operation Buttons for Still Image Playback

During Index Screen Display

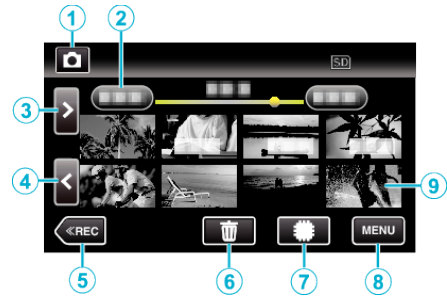

- Still images that are recorded continuously in high-speed or medium-speed will be grouped together. Only the first recorded file (still image) is shown and the group is displayed with a green frame.

	Display	Description
①	Video/Still Image Mode 	Switches between video and still image modes.
②	Date	Moves to the previous/next date
③	>	Displays the next index screen (thumbnail display) • You can perform the same operation with the zoom lever.
④	<	Displays the previous index screen (thumbnail display) • You can perform the same operation with the zoom lever.
⑤	<<REC	Switches to the recording mode.
⑥		Displays the index screen (thumbnail display) to perform deletion
⑦		Switches between the index screen of the built-in memory and SD card
⑧	MENU	Displays the menu screen
⑨	File (Still Image)	Tap on thumbnail - Starts playback Drag to right - Scrolls to the right to show the previous index screen (thumbnail display) Drag to left - Scrolls to the left to show the next index screen (thumbnail display)

During Still Image Playback

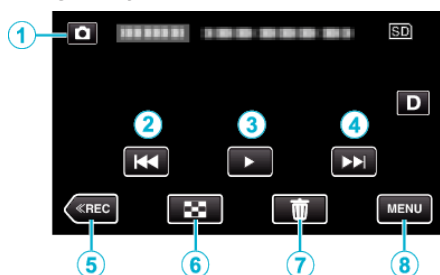

- When this unit is not operated, the operation buttons on the touch screen disappear automatically. Tap on the screen to display the operation buttons again.

	Display	Description
①	Video/Still Image Mode 📺/📷	Switches between video and still image modes.
②	⏮	Returns to the previous still image • You can perform the same operation with the zoom lever.
③	▶/⏸	Starts/pauses slideshow • The same operation can be performed with the SET button.
④	⏭	Advances to the next still image • You can perform the same operation with the zoom lever.
⑤	⏪REC	Switches to the recording mode.
⑥	📶	Returns to index screen
⑦	🗑	Deletes the currently displayed still image.
⑧	MENU	Displays the menu screen

Memo :

- Tap or drag on the operation area of the touch screen.

Caution :

- This unit is a microcomputer-controlled device. Electrostatic discharge, external noise and interference (from a TV, a radio, etc.) might prevent it from functioning properly. In such a case, close the monitor screen to turn off the power and remove the AC adapter, then press the Reset button to reset this unit.

“Resetting this Unit” (📖 p. 7)

Slideshow Playback

Still images can be played back in a slideshow.
Tap ▶ during still image playback to start the slideshow.

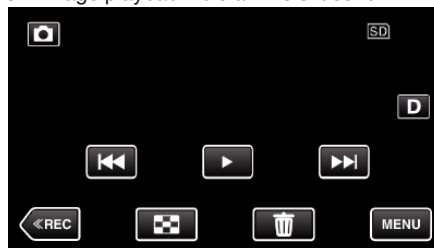

“Operation Buttons for Still Image Playback” (📖 p. 56)

Memo :

- Effects can be added to the transitions in slideshow playback.

“SLIDE SHOW EFFECTS” (📖 p. 160)

Connecting to and Viewing on TV

You can connect this unit to a TV for playback. The image quality on TV varies with the type of TV and the connecting cable. Select the connector that best suits your TV.

- Refer also to the instruction manual of the TV in use.

“Connecting via the HDMI Mini Connector” (☞ p. 58)

“Connecting via the AV Connector” (☞ p. 60)

- To display the date and time on TV, set both “DISPLAY DATE/TIME” and “DISPLAY ON TV” to “ON”.

(☞ p. 158)

“DISPLAY ON TV” (☞ p. 164)

Unnatural Displays on TV

Trouble	Action
Images do not appear on the TV properly.	<ul style="list-style-type: none"> • Disconnect the cable and connect again. • Turn off and on this unit again. • Images may not appear properly when the remaining battery power is low. Use an AC adapter.
Images are projected vertically on the TV.	<ul style="list-style-type: none"> • Set “VIDEO OUTPUT” in the “CONNECTION SETTINGS” menu to “4:3”. <p>“VIDEO OUTPUT” (☞ p. 164)</p>
Images are projected horizontally on the TV.	<ul style="list-style-type: none"> • Adjust the TV’s screen accordingly.
The color of images looks strange.	<ul style="list-style-type: none"> • Adjust the TV’s screen accordingly.
HDMI-CEC functions do not work properly, and the TV does not work in conjunction with this unit.	<ul style="list-style-type: none"> • TVs may operate differently depending on the specifications, even if they are HDMI-CEC compliant. Therefore, the HDMI-CEC functions of this unit cannot be guaranteed to operate in combination with all the TVs. In such cases, set “HDMI CONTROL” to “OFF”. <p>“HDMI CONTROL” (☞ p. 164)</p>
The language on the display changed.	<ul style="list-style-type: none"> • It may occur when you connect this unit to a TV with different language setting using an HDMI mini cable.

Caution :

- Do not remove the recording medium or perform any other operation (such as turning off the power) while accessing files. Also, be sure to use the provided AC adapter, as the data on the recording medium may be corrupted if the battery becomes exhausted during operation. If the data on the recording medium becomes corrupted, format the recording medium to use the medium again.

Connecting via the HDMI Mini Connector

If you are using an HDTV, you can play back in HD quality by connecting to the HDMI mini connector.

- Use a High Speed HDMI mini cable as the HDMI mini cable.
- Refer also to the instruction manual of the TV in use.

- 1 Connect to a TV.

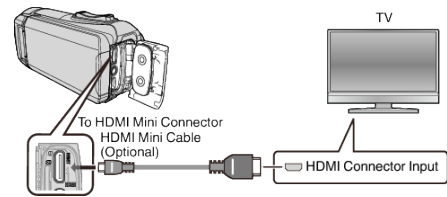

- 2 Connect the adapter cable and AC adapter to this unit.

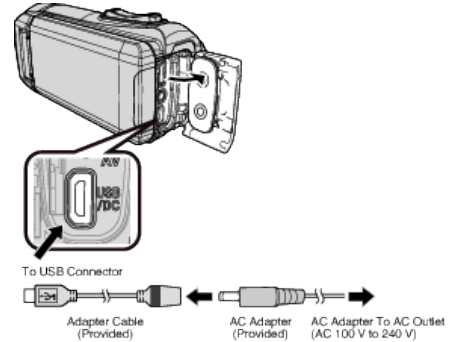

- 3 Open the LCD monitor.

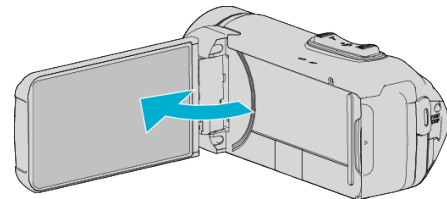

- The unit turns on automatically.

- 4 Press the external input button on the TV to switch to the input from this unit via the connected connector.



- 5 Play back a file.



“Playing Back Videos” (☞ p. 49)

“Playing Back Still Images” (☞ p. 56)

Memo :

- Change the settings in “HDMI OUTPUT” according to the connection. “HDMI OUTPUT” (☞ p. 164)
- When connected to the TV via the HDMI mini cable, images and sounds may not be output properly depending on the TV connected. In such cases, perform the following operations.
 - 1) Disconnect the HDMI mini cable and connect it again.
 - 2) Turn off and on this unit again.
- For questions about the TV or method of connection, contact your TV's manufacturer.

Operating in Conjunction with TV via HDMI

Connecting this unit to an HDMI-CEC enabled TV using the HDMI mini cable allows linked operations with the TV to be performed.

- HDMI-CEC (Consumer Electronics Control) is an industry standard that enables interoperability between HDMI-CEC compliant devices that are connected via HDMI cables.

Memo :

- Not all HDMI control devices comply with the HDMI-CEC standard. The HDMI control function of this unit will not work when connected to these devices.
- This unit is not guaranteed to operate with all HDMI-CEC enabled devices.
- Depending on the specifications of each HDMI-CEC enabled device, some functions may not work with this unit. (For details, refer to the instruction manual of your TV.)
- Unintended operations may occur with some connected devices. In these cases, set “HDMI CONTROL” to “OFF”.

“HDMI CONTROL” (☞ p. 164)

Preparations

- Connect an HDMI mini cable between this unit and the TV. “Connecting via the HDMI Mini Connector” (☞ p. 58)
- Turn on the TV and set the HDMI-CEC related setting to “ON”. (For details, refer to the instruction manual of the TV.)
- Set “HDMI CONTROL” in the CONNECTION SETTINGS menu to “ON”. “HDMI CONTROL” (☞ p. 164)

Operation Method 1

- 1 Turn on this unit.
- 2 Select the playback mode.
- 3 Connect the HDMI mini cable.
 - TV turns on automatically and switches to HDMI input mode when this unit is turned on.

Operation Method 2

- 1 Turn off the TV.
 - This unit turns off automatically.

Memo :

- Depending on the TV connected, the display language of this unit will automatically switch to the language that is selected for the TV when this unit is turned on. (This is applicable only if this unit supports the language selected for the TV.) To use this unit with a language that differs from the display language of the TV, set “HDMI CONTROL” to “OFF”.
- The display language of the TV will not switch automatically, even if the display language of this unit is changed.
- These functions may not work correctly when devices such as amplifier and selector are connected. Set “HDMI CONTROL” to “OFF”.
- If HDMI-CEC does not work properly, turn off and on this unit again.

Connecting via the AV Connector

To playback videos on TV, connect the AV cable (provided: QAM1322-001) to the AV terminal of this unit.

- Refer also to the instruction manual of the TV in use.

1 Connect to a TV.

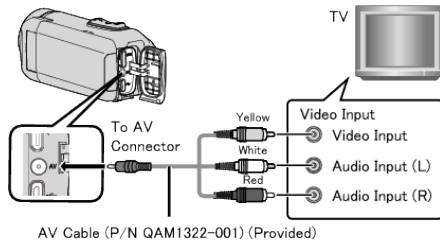

To purchase, consult your nearest JVC service center.

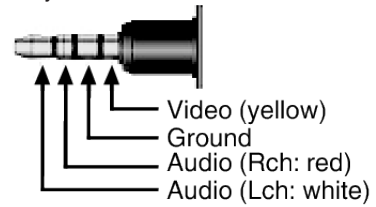

- When using the optional AV cable, attach the core filter provided with this unit first.

“Attaching the Core Filter” (p. 10)

2 Connect the adapter cable and AC adapter to this unit.

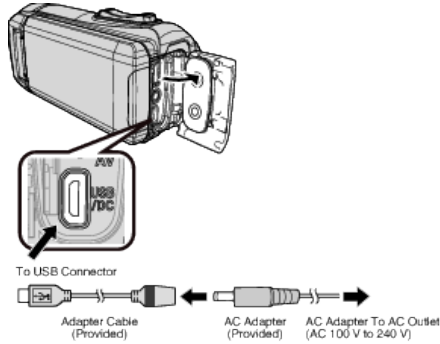

3 Open the LCD monitor.

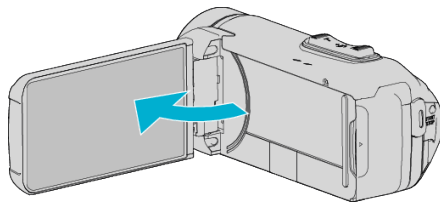

- The unit turns on automatically.

4 Press the external input button on the TV to switch to the input from this unit via the connected connector.

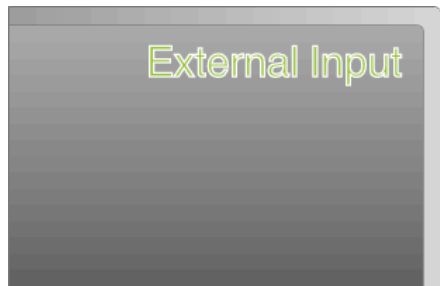

5 Play back a file.



“Playing Back Videos” (p. 49)

“Playing Back Still Images” (p. 56)

Memo :

- For questions about the TV or method of connection, contact your TV's manufacturer.

- AV cable (provided: QAM1322-001)

Wiring specifications (for video/audio) of the 4-pole mini plug are described in the following.

Deleting Unwanted Files

Delete unwanted videos and still images when the space in the recording media is running out.

Doing so frees up more space in the recording media.

“Deleting the Currently Displayed File” (p. 61)

“Deleting Selected Files” (p. 61)

Memo :

- Deleted files cannot be restored.
 - When files in a playlist are deleted, the playlist changes.
 - Files that are protected cannot be deleted.
Release protection before deleting the file.
- “Protecting Files” (p. 62)
- Be sure to back up important files on a computer.
- “Backing Up All Files” (p. 97)

Deleting the Currently Displayed File

Deletes the currently displayed file.

Caution :

- Deleted files cannot be restored.

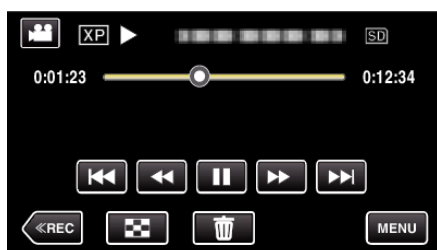

1 Tap .

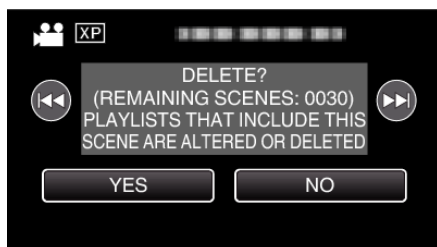

- While the video mode is shown in the image, the same operations apply for the still image mode.

2 Tap “YES”.



- Tap  /  to select the previous or next file.
- When no file remains, the screen returns to the index screen.

Deleting Selected Files







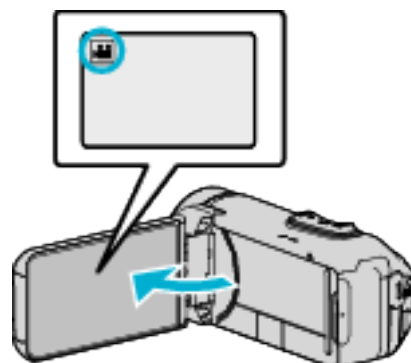

Deletes the selected files.

Caution :

- Deleted files cannot be restored.

1 Open the LCD monitor.



- Tap  or  to select the video or still image mode.
- Tap  or  on the recording screen to display the mode switching screen.
Tap  to switch to the video mode .
Tap  to switch to the still image mode .

2 Tap  to select the playback mode.

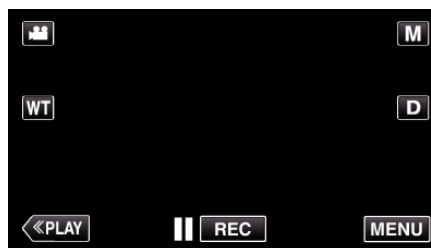

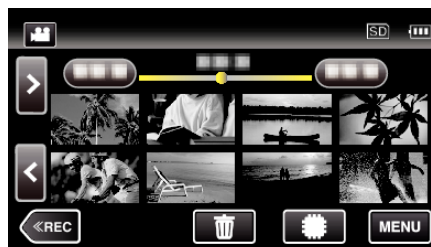

- While the video mode is shown in the image, the same operations apply for the still image mode.

3 Tap .

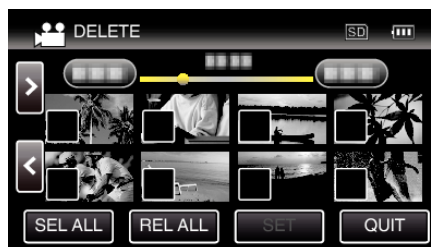

4 Tap on the files to delete.



-  appears on the selected files.
To remove  from a file, tap on the file again.
- Tap “SEL ALL” to select all files.
- Tap “REL ALL” to release all selections.

5 Tap "SET".

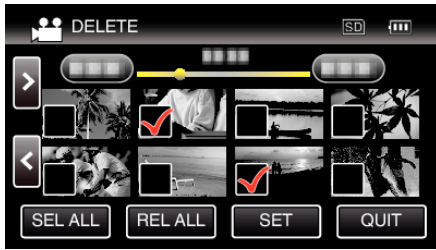

- If no file is selected, the "SET" button cannot be pressed.

6 Tap "EXECUTE" to confirm the deletion.



- After deleting is complete, tap "OK".
- To cancel the deletion, tap "QUIT".

Protecting Files

Prevent important videos/still images from being deleted accidentally by protecting them.

"Protecting/Releasing Protection of the Currently Displayed File"

(☰ p. 62)

"Protecting/Releasing Protection of Selected Files" (☰ p. 63)

Caution :

- When the recording media is formatted, even the protected files will be deleted.

Protecting/Releasing Protection of the Currently Displayed File

Protects or releases protection of the currently displayed file.

1 Tap "MENU".

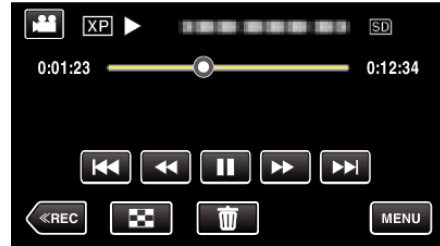

- While the video mode is shown in the image, the same operations apply for the still image mode.

2 Tap "EDIT".

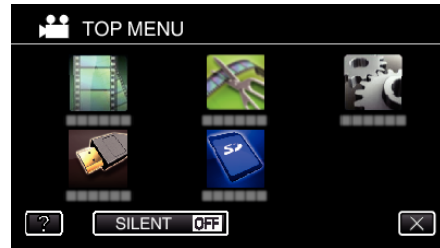

3 Tap "PROTECT/CANCEL".

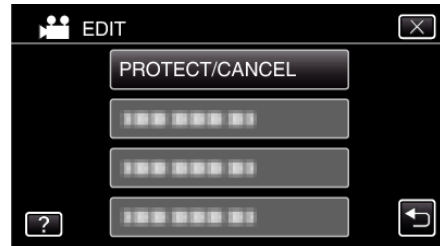

4 Tap "YES".



- Tap ◀◀/▶▶ to select the previous or next file.
- After setting, tap "OK".

Protecting/Releasing Protection of Selected Files

Protects or releases protection of the selected files.

1 Open the LCD monitor.

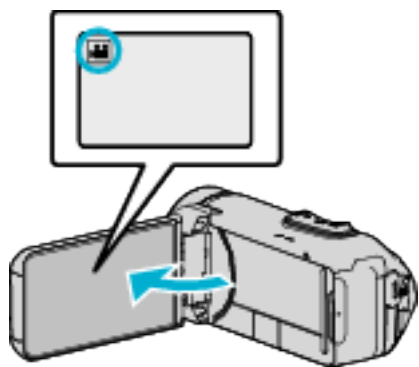

- Tap or to select the video or still image mode.
- Tap or on the recording screen to display the mode switching screen.
Tap to switch to the video mode .
- Tap to switch to the still image mode .

2 Tap **<<PLAY** to select the playback mode.

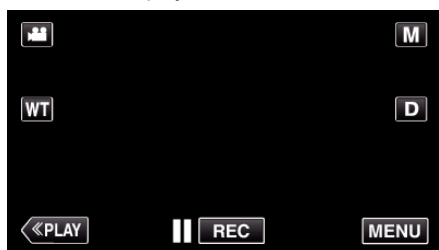

- While the video mode is shown in the image, the same operations apply for the still image mode.

3 Tap "MENU".

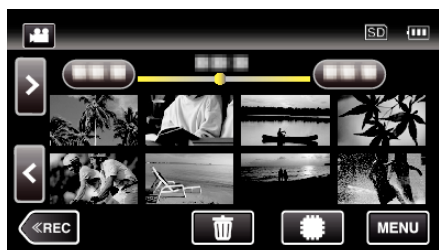

4 Tap "EDIT".



5 Tap "PROTECT/CANCEL".

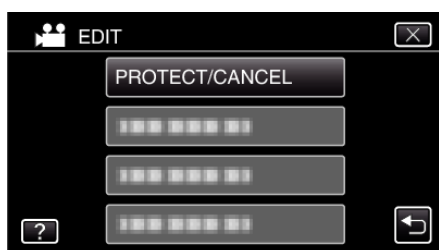

6 Tap on the files to protect or release protection of.

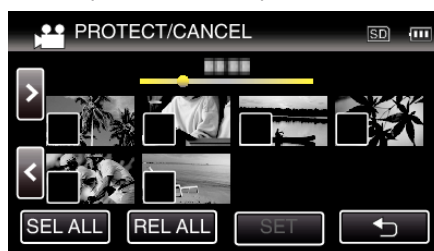

- ✓ appears on the selected files.
To remove ✓ from a file, tap on the file again.
- and ✓ are displayed on the files that are already protected.
To release protection of a file, tap on the file such that ✓ is removed.
- Tap "SEL ALL" to select all files.
- Tap "REL ALL" to release all selections.

7 Tap "SET" to complete the setting.



- Protect marks appear on the selected files.
Protect marks disappear from the deselected files.
- If no file is selected, the "SET" button cannot be pressed.

Capturing a Still Image in the Video During Playback

You can capture still images of the scenes you like in the recorded videos.

- 1 Open the LCD monitor.

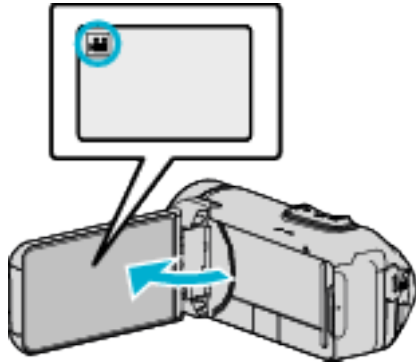

- Check if the recording mode is .
- If the mode is still image, tap on the recording screen to display the mode switching screen.
Tap to switch the mode to video.

- 2 Tap **<<PLAY** to select the playback mode.

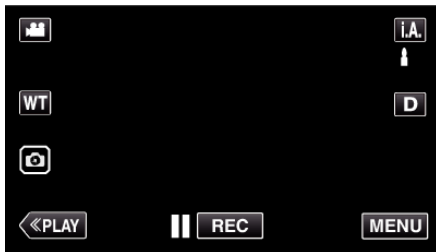

- 3 Tap on the desired video.



- 4 Tap pause **||** at the desired scene during playback.

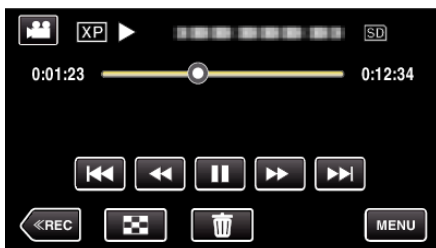

- After pausing the video, you can fine-tune the point to capture by tapping forward slow-motion and reverse slow-motion .

- 5 Tap the button.

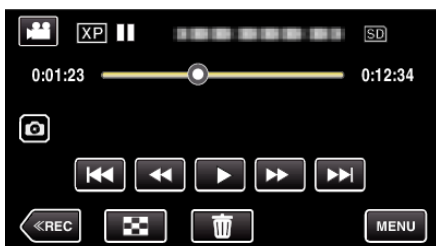

- Captured still images are stored in the media where the video is being played back from.

Memo :

- Still images are captured with a size of 1920×1080.

Combining Videos Recorded by Seamless Recording

Videos that are recorded on two separate media and with "SEAMLESS RECORDING" in the video recording menu enabled can be combined into a single video.

"SEAMLESS RECORDING" (p. 151)

1 Open the LCD monitor.

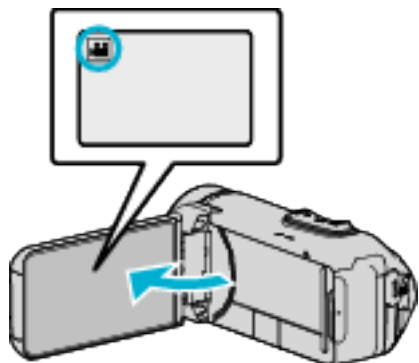

- Check if the recording mode is .
- If the mode is still image, tap on the recording screen to display the mode switching screen. Tap to switch the mode to video.

2 Tap <<PLAY to select the playback mode.

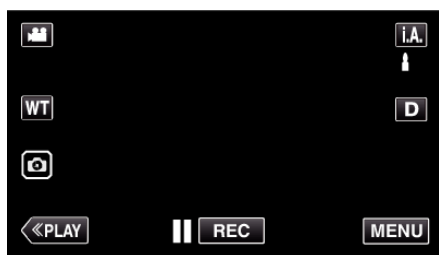

3 Tap "MENU".

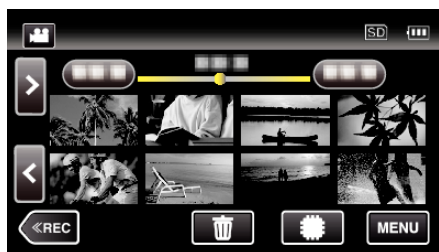

4 Tap "EDIT".



5 Tap "SEAMLESS REC CTRL".

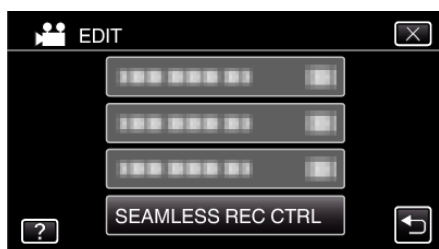

6 Tap "COMBINE SCENES".



- This unit starts a search to detect seamless videos. Combining cannot be performed if no seamless videos are found.

7 Tap "YES".

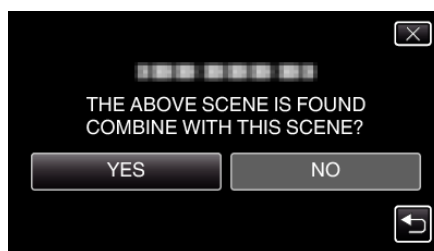

8 Tap the media to store to.

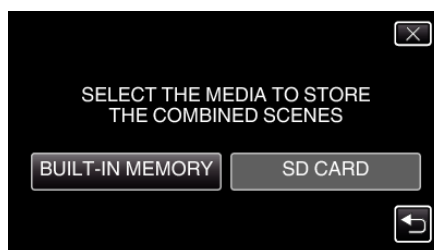

9 Tap "YES".

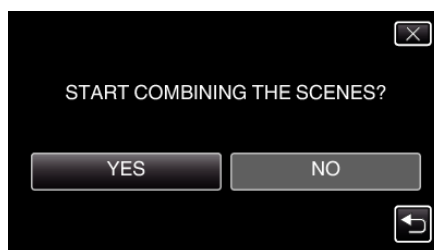

- Combining of the videos starts.
- After videos are combined, tap "OK".

Memo :

- Seamless videos cannot be combined if there is not enough free space in the built-in memory or SD card. Check the amount of remaining free space before combining.

How to Enable Seamless Video Recording Again

To start seamless recording again after the previous session is complete, it is necessary to combine seamless videos, or delete the combination information of the seamless videos.

To delete the combination information of seamless videos, select "DEL COMBINED SCENES" in step 6.

Capturing a Required Part in the Video (TRIMMING)

Select the required part of a video and save it as a new video file.

- The original video remains in its existing location.

1 Open the LCD monitor.

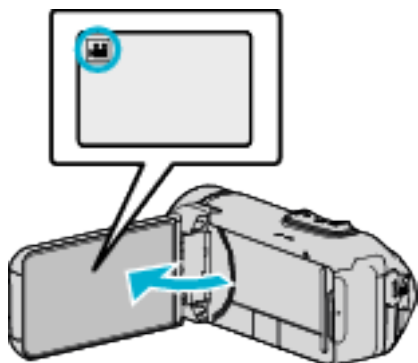

- Check if the recording mode is .
- If the mode is still image, tap on the recording screen to display the mode switching screen. Tap to switch the mode to video.

2 Tap **PLAY** to select the playback mode.

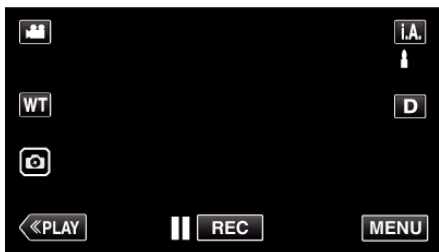

3 Tap **MENU**.



4 Tap **EDIT**.



5 Tap **TRIMMING**.

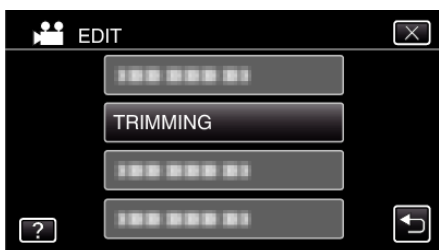

6 Tap the video to edit.

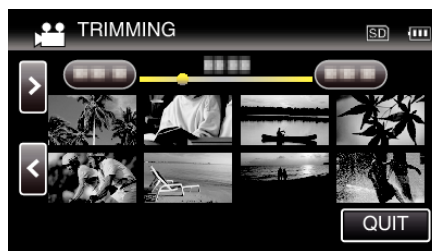

7 Tap **A** to pause playback at the desired start point, then tap **A**.

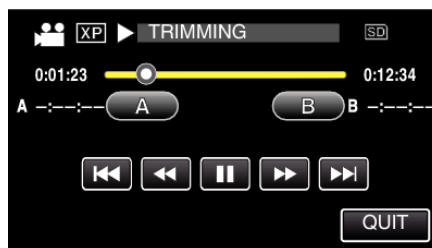

- When **A** is tapped, the start point is set.
- After setting the start point, tap **▶** to continue playback.

8 Tap **B** to pause playback at the desired end point, then tap **B**.

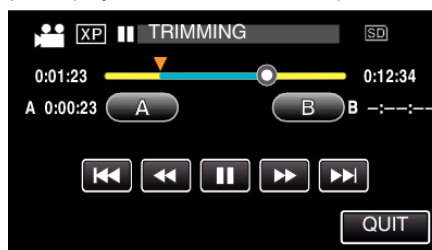

- When **B** is tapped, the end point is set.
- To reset the start or end point, tap **A** or **B** at the desired scene (position).
- You can fine adjust the position by pressing **◀** and **▶** while playback is paused.

9 Tap **SET**.

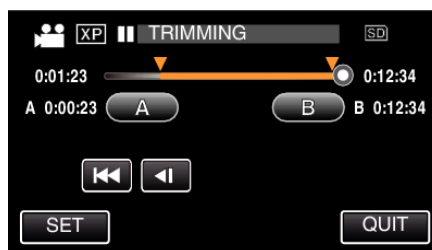

- When **SET** is tapped, the trimming area is confirmed.

10 Tap **YES**.



- After copying, tap **OK**.
- When copying finishes, the copied file is added to the index screen.

Memo : _____

- The division point may deviate slightly from the selected scene.

Deleting Playlists

Delete the playlists that you have created.

1 Open the LCD monitor.

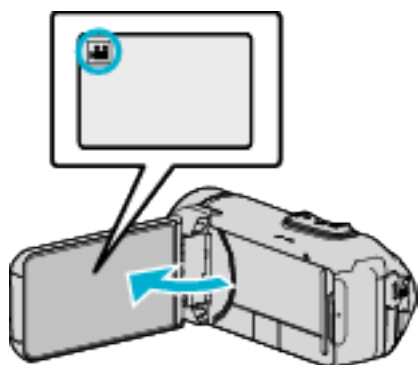

- Check if the recording mode is .
- If the mode is still image, tap on the recording screen to display the mode switching screen. Tap to switch the mode to video.

2 Tap **<<PLAY** to select the playback mode.

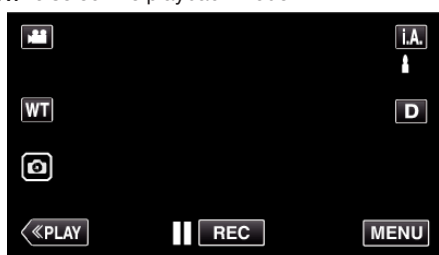

3 Tap "MENU".

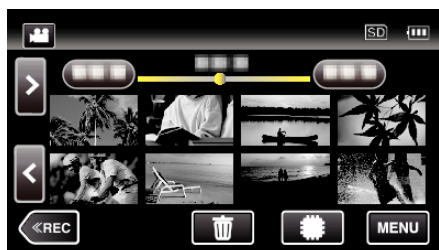

4 Tap "PLAYBACK SETTING".



5 Tap "PLAYBACK PLAYLIST".

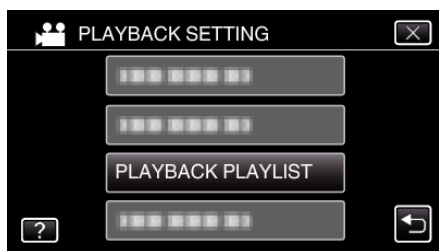

6 Tap .

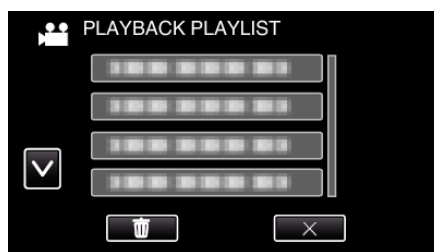

- The DELETE screen appears.

7 Tap on the playlist to delete, and tap "NEXT".

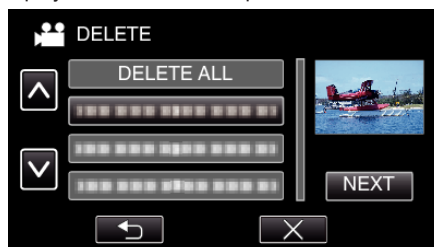

- All created playlists will be deleted when "DELETE ALL" is selected.

8 Tap "YES" to confirm the deletion.

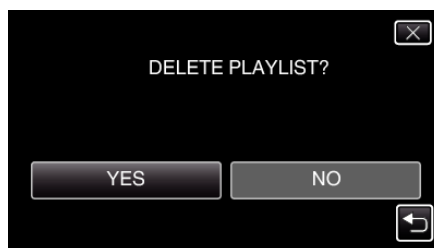

- After deleting, tap "OK".
- After deleting is complete, the screen returns to the delete playlist selection screen.

Memo : _____

- Tap **X** on each screen to exit the menu.

Creating Discs with a BD Writer (External Blu-ray Drive)

*The JVC external Blu-ray drive is known as “BD writer”.
You can copy the recorded files to discs or play back the created discs using an optional BD writer (external Blu-ray drive).

Compatible BD Writers (External Blu-ray Drives)

You can use BE08LU20 from LG. (as of March, 2014)

Creating Discs with a BD Writer

■ Preparing a BD Writer

“Preparing a BD Writer (External Blu-ray Drive)” (☞ p. 68)

■ Copying to Discs

“Copying All Files” (☞ p. 69)

“Copying Selected Playlists” (☞ p. 71)

“Copying Selected Files” (☞ p. 73)

Select and copy the desired videos or still images individually.

■ Other Operations

“Playing Back with a BD Writer (External Blu-ray Drive)” (☞ p. 75)

Memo :

- Discs in the DVD-Video format cannot be created.
- 50i video, 50p video and still images cannot be copied onto the same disc.
- Videos that are recorded in the 50p mode (when “SYSTEM SELECT” is set to “50p”) can only be copied to Blu-ray discs.
- The recordable time on the disc varies according to the way of recording.
- You cannot create a disc if the remaining battery power is not enough. Charge this unit fully beforehand.
- If you copy many images at once, it may not be possible to create the disc halfway through the process. If the volume of the image data is large, copy the data in several times.
- When backing up the files, it may take time for the backup to be completed. Wait for a while as the POWER/ACCESS lamp appears blinking, which indicates normal operation.
- Date and time information as saved as subtitles in the created discs.

Preparing a BD Writer (External Blu-ray Drive)

Caution :

- You cannot create a disc if the remaining battery power is not enough. Charge this unit fully beforehand.
- Do not use the AC adapter provided with this unit.

Memo :

- When connecting this unit to the BD writer (external Blu-ray drive), purchase the following USB conversion cable (optional).
Part number: QAM1588-001 * Micro A (Male) – Mini AB (Female)
* Consult your nearest service center.

- 1 Open the terminal cover.
- 2 Connect the USB cable and the AC adapter of the BD writer.
 - Before making any connection, close the LCD monitor to turn off this unit.

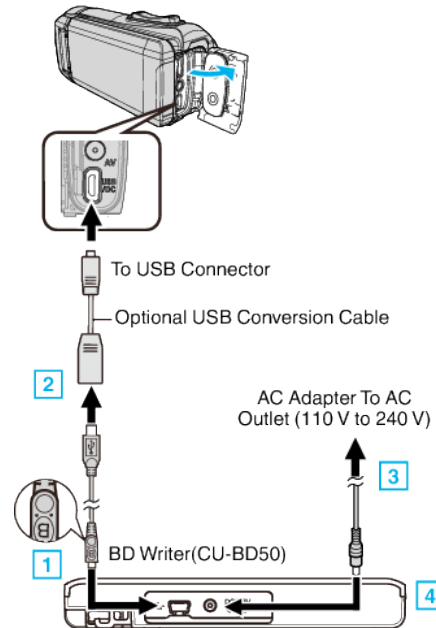

Connect the USB cable of the BD writer (external Blu-ray drive).

- The USB cable provided with this unit cannot be used.

- 1 Connect the USB cable provided with the BD writer to the BD writer using the end with the “B” marking.
- 2 Attach the USB cable to an optional USB conversion cable, then connect to this unit.
- 3 Plug the AC adapter of the BD writer into the power outlet.
- 4 Connect the other end of the AC adapter to the BD writer.
 - The BD writer turns on.
 - Refer also to the instruction manual of the BD writer (external Blu-ray drive). For details on the connection, please refer to the above.

- 3 Open the LCD monitor.

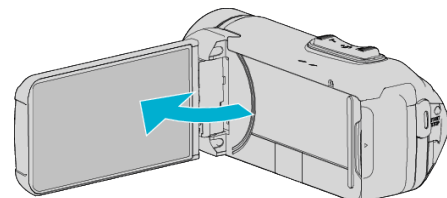

- This unit turns on and the “BACK-UP” menu appears.
- While the USB cable is connected, the “BACK-UP” menu is displayed.

4 Insert a new disc.



- 1 Press the eject button to open the disc tray.
- 2 Load a new disc properly.
- 3 Press the eject button to close the disc tray.

Caution :

- Be sure to turn off the power when connecting the devices. Otherwise, electric shocks or malfunctions may occur.
- Do not connect the AC adapter provided with this unit to the BD writer.
- Do not connect the AC adapter provided with the BD writer to this unit.

Creating a Disc

Creating a Disc

Caution :

- You cannot create a disc if the remaining battery power is not enough. Charge this unit fully beforehand.

- 1 Preparing a BD Writer (External Blu-ray Drive)
 - Insert a new disc into the BD writer (external Blu-ray drive).
“Preparing a BD Writer (External Blu-ray Drive)” (p. 68)
- 2 Copy files to the disc with the following methods.
 - “Copying All Files” (p. 69)
 - “Copying Selected Playlists” (p. 71)
 - “Copying Selected Files” (p. 73)

Copying All Files

All videos or still images recorded on this unit will be copied. You can also select and copy only the videos or still images that have never been copied.

- 1 Select video or still image mode.
- 2 Tap “CREATE FROM ALL” (video) or “SAVE ALL” (still image).

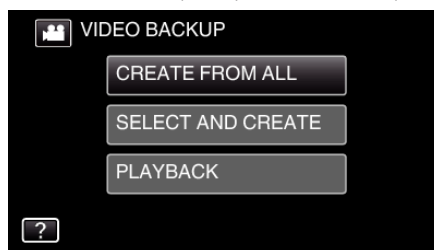

- While the video mode is shown in the image, the same operations apply for the still image mode.
- Tap the person icon to switch between the video (50i), video (50p), and still image modes. Switch to the mode in which you want to copy files.

- 3 Tap “Blu-ray DISC” or “DVD(AVCHD)”.

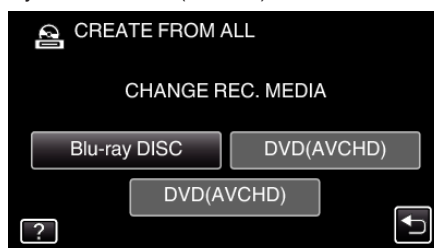

- The media changes to the tapped item. Select the appropriate setting according to the disc.
- Selecting “Blu-ray DISC” enables you to save videos in a Blu-ray disc in the high definition quality.
- Selecting “DVD(AVCHD)” enables you to save videos in a DVD in the high definition quality.

- 4 Tap the media you would like to make a backup.

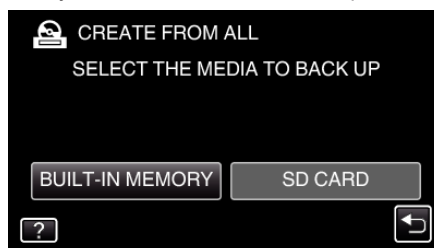

5 Tap the desired method.

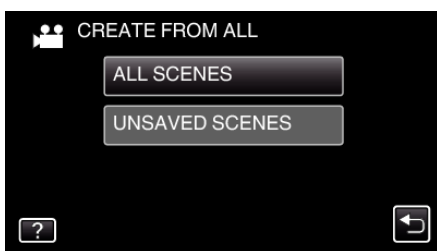

- **“ALL SCENES” (video)/“ALL IMAGES” (still image):**

All videos or still images in this unit are copied.

- **“UNSAVED SCENES” (video)/“UNSAVED IMAGES” (still image):**

Videos or still images that have never been copied are automatically selected and copied.

6 Tap “EXECUTE”.

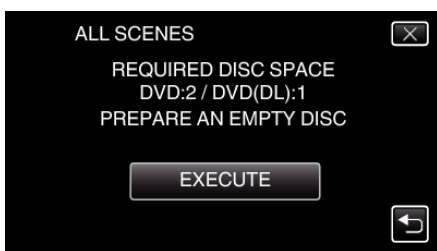

- The number of discs required to copy the files is displayed. Prepare the discs accordingly.

7 Tap “AUTO” or “BY DATE”. (👤 mode only)

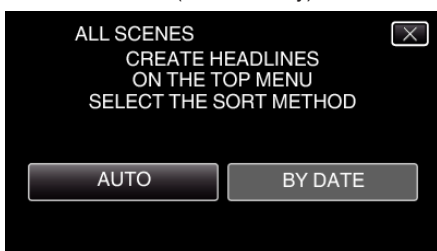

- When “AUTO” is selected, videos with similar recording dates are displayed in groups.
- When “BY DATE” is selected, videos are displayed according to recording dates.

8 Tap “EXECUTE”.



- When “INSERT THE NEXT DISC TO CREATE OR PRESS STOP TO EXIT” appears, change the disc.

9 Tap “OK” when “COMPLETED” is displayed.

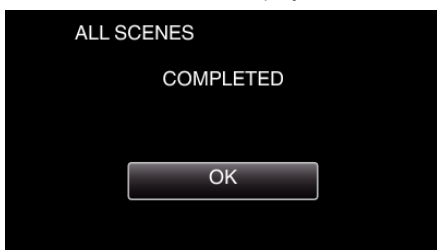

10 Close the LCD monitor of this unit to turn off this unit and disconnect the USB cable.

Caution :

- If you copy many images at once, it may not be possible to create the disc halfway through the process. If the volume of the image data is large, copy the data in several times.
- Do not turn off the power or remove the USB cable until copying is complete.
- Files that are not on the index screen during playback cannot be copied. Special files cannot be copied either.
- All DVDs will be finalized automatically. While files cannot be added to the DVD-R/DVD-RW later, files can still be added to the BD-R/BD-RE.
- If the created BD-R/BD-RE is played back on a Blu-ray recorder, your Blu-ray recorder may disable additional recording on the BD-R/BD-RE. In this case, files cannot be added to the disc.
- If you stop the process of creating the disc at the screen for creating disc, the disc in use for writing cannot be used again.
- DVDs that are created in “DVD(AVCHD)” format are playable only on AVCHD compatible devices.
- Videos that are recorded in the 50p mode (when “SYSTEM SELECT” is set to “50p”) can only be copied to Blu-ray discs.
- Blu-ray discs containing videos that are recorded in the 50p mode (when “SYSTEM SELECT” is set to “50p”) are playable only on AVCHD Progressive compatible devices.
- Videos recorded in “UXP” video quality cannot be copied to DVDs (AVCHD format). Copy to a BD.

Memo :

- To check the created disc, refer to ““Playing Back with a BD Writer (External Blu-ray Drive)” (📖 p. 75) ”.

“Playing Back with a BD Writer (External Blu-ray Drive)” (📖 p. 75)

Copying Selected Playlists

Arrange and copy the playlist registered in Digest Playback in the order you like.

- 1 Select video mode.
- 2 Tap "SELECT AND CREATE".



- 3 Tap "Blu-ray DISC" or "DVD(AVCHD)".



- The media changes to the tapped item. Select the appropriate setting according to the disc.
- Selecting "Blu-ray DISC" enables you to save videos in a Blu-ray disc in the high definition quality.
- Selecting "DVD(AVCHD)" enables you to save videos in a DVD in the high definition quality.

- 4 Tap the media you would like to make a backup.

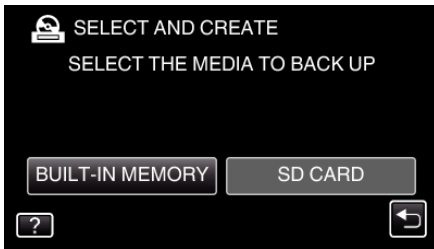

- 5 Tap "CREATE BY PLAYLIST".

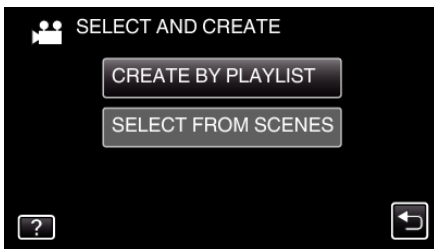

- 6 Tap on the playlist to copy to disc.

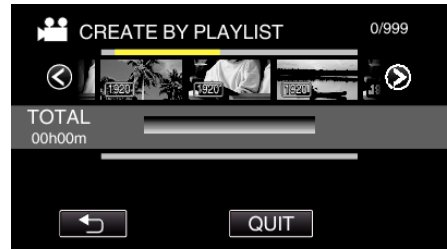

- ▶ appears on the selected playlist (upper row). Tap ↵ to deselect.
- Tap on the selected playlist again to check the content of the playlist. After checking, tap ↵.
- Tap </> or move the zoom lever to display the previous/next playlist.

- 7 Tap "ADD" to insert a playlist.

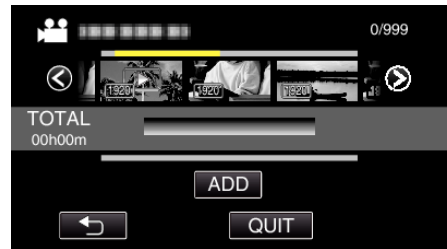

- Repeat steps 6-7 and arrange the playlists.
- To change the position of a playlist (lower row), select the insertion point with ←/→ after step 6 and tap "ADD".
- ▶ appears when the inserted playlist is selected. Tap ↵ to deselect.
- Tap on the selected playlist again to check the content of the playlist. After checking, tap ↵.
- To delete a video in the playlist (lower row), tap the video, then tap "CANCEL".

- 8 After arranging, tap "SAVE".

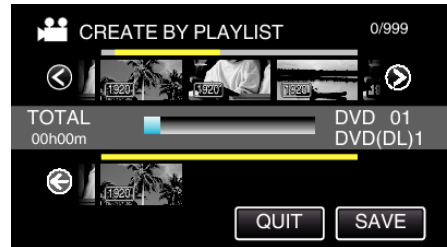

- 9 Tap "EXECUTE".

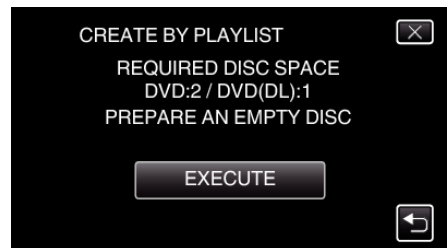

- The number of discs required to copy the files is displayed. Prepare the discs accordingly.

10 Tap "OK".

- If step 10 is not displayed, go to step 11.

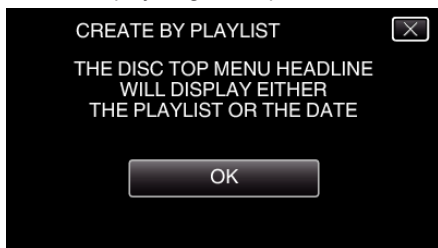

Alternatively, tap "AUTO" or "BY DATE".

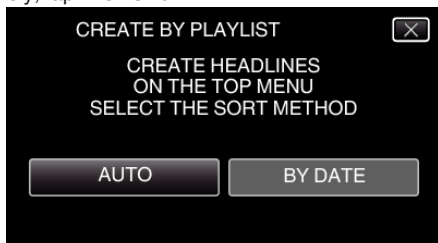

- When "AUTO" is selected, videos with similar recording dates are displayed in groups.
- When "BY DATE" is selected, videos are displayed according to recording dates.

11 Tap "EXECUTE".

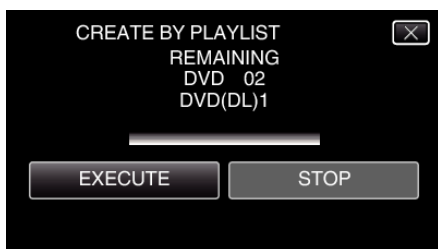

- When "INSERT THE NEXT DISC TO CREATE OR PRESS STOP TO EXIT" appears, change the disc.

12 Tap "OK" when "COMPLETED" is displayed.

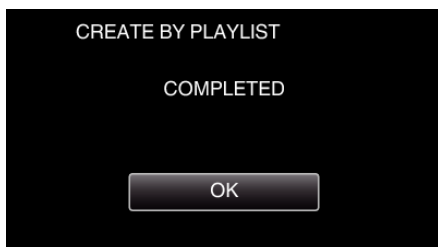

13 Close the LCD monitor of this unit to turn off this unit and disconnect the USB cable.

Caution :

- If you copy many images at once, it may not be possible to create the disc halfway through the process. If the volume of the image data is large, copy the data in several times.
- Do not turn off the power or remove the USB cable until copying is complete.
- Files that are not on the index screen during playback cannot be copied. Special files cannot be copied either.
- All DVDs will be finalized automatically. While files cannot be added to the DVD-R/DVD-RW later, files can still be added to the BD-R/BD-RE.
- If the created BD-R/BD-RE is played back on a Blu-ray recorder, your Blu-ray recorder may disable additional recording on the BD-R/BD-RE. In this case, files cannot be added to the disc.
- If you stop the process of creating the disc at the screen for creating disc, the disc in use for writing cannot be used again.
- DVDs that are created in "DVD(AVCHD)" format are playable only on AVCHD compatible devices.
- Videos that are recorded in the 50p mode (when "SYSTEM SELECT" is set to "50p") can only be copied to Blu-ray discs.

- Blu-ray discs containing videos that are recorded in the 50p mode (when "SYSTEM SELECT" is set to "50p") are playable only on AVCHD Progressive compatible devices.
- Videos recorded in "UXP" video quality cannot be copied to DVDs (AVCHD format). Copy to a BD.

Memo :

- A list of playlists is displayed on the top menu of the created DVD.
- To check the created disc, refer to "Playing Back with a BD Writer (External Blu-ray Drive)" (p. 75).

"Playing Back with a BD Writer (External Blu-ray Drive)" (p. 75)

Copying Selected Files

Select and copy the desired videos or still images individually. There are 2 ways to select images.

- Selecting Files One by One
- Specify a "FROM HERE" to "UNTIL HERE" range.

■ Copying Selected Files One by One

- 1 Select video or still image mode.
- 2 Tap "SELECT AND CREATE" (video) or "SELECT AND SAVE" (still image).

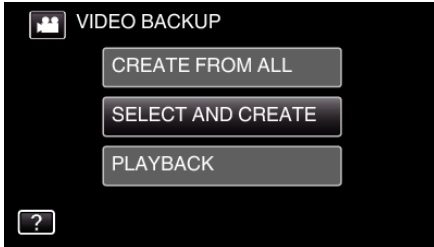

- While the video mode is shown in the image, the same operations apply for the still image mode.
- Tap to switch between the video and still image modes.

- 3 Tap "Blu-ray DISC" or "DVD(AVCHD)".



- The media changes to the tapped item. Select the appropriate setting according to the disc.
- Selecting "Blu-ray DISC" enables you to save videos in a Blu-ray disc in the high definition quality.
- Selecting "DVD(AVCHD)" enables you to save videos in a DVD in the high definition quality.

- 4 Tap the media you would like to make a backup.

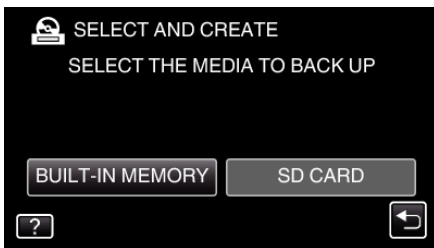

- 5 Tap "SELECT FROM SCENES" (video) or "SELECT FROM IMAGES" (still image).

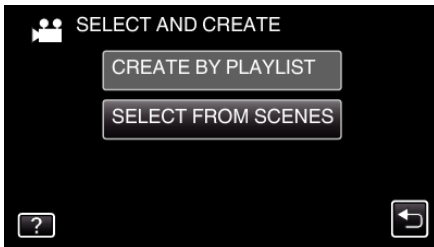

- While the video mode is shown in the image, the same operations apply for the still image mode.

- 6 Tap on the videos or still images to copy.

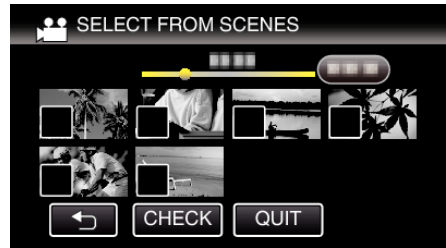

- ✓ appears on the selected files. To remove ✓ from a file, tap on the file again.
- Tap "CHECK" to check the file. After checking, tap .

- 7 After selecting all the files, tap "SAVE".

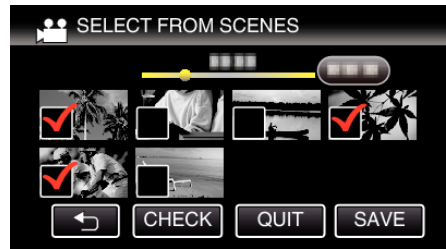

- 8 Tap "EXECUTE".

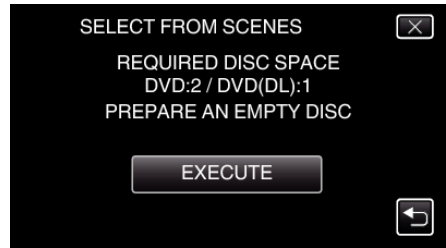

- The number of discs required to copy the files is displayed. Prepare the discs accordingly.

- 9 Tap "AUTO" or "BY DATE". (👤 mode only)

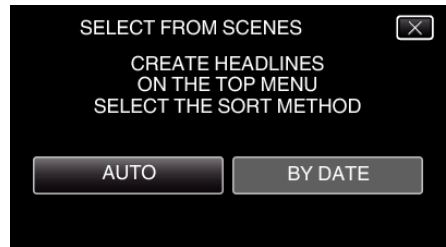

- When "AUTO" is selected, videos with similar recording dates are displayed in groups.
- When "BY DATE" is selected, videos are displayed according to recording dates.

- 10 Tap "EXECUTE".



- When "INSERT THE NEXT DISC TO CREATE OR PRESS STOP TO EXIT" appears, change the disc.

11 Tap "OK" when "COMPLETED" is displayed.

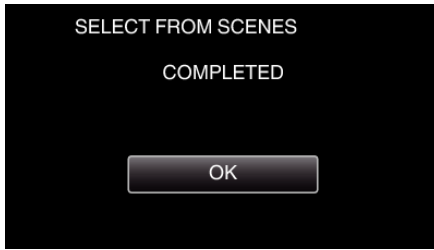

12 Close the LCD monitor of this unit to turn off this unit and disconnect the USB cable.

Specify the range to copy the files.

1 Select video or still image mode.

2 Tap "SELECT AND CREATE" (video) or "SELECT AND SAVE" (still image).

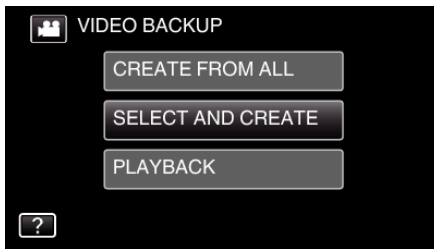

- While the video mode is shown in the image, the same operations apply for the still image mode.
- Tap to switch between the video and still image modes.

3 Tap "Blu-ray DISC" or "DVD(AVCHD)".



- The media changes to the tapped item. Select the appropriate setting according to the disc.
- Selecting "Blu-ray DISC" enables you to save videos in a Blu-ray disc in the high definition quality.
- Selecting "DVD(AVCHD)" enables you to save videos in a DVD in the high definition quality.

4 Tap the media you would like to make a backup.



5 Tap "SELECT FROM SCENES" (video) or "SELECT FROM IMAGES" (still image).

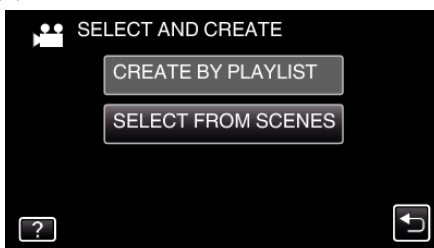

- While the video mode is shown in the image, the same operations apply for the still image mode.

6 Tap "RANGE".

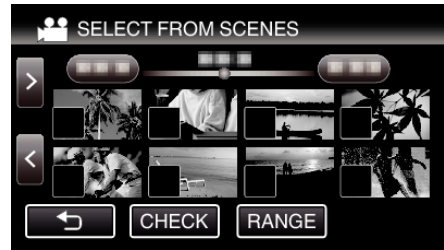

7 Tap the first image (thumbnail) of the range to be copied.

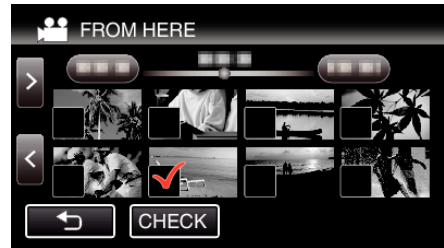

- ✓ is added to all the files to be copied when "CHECK" is tapped.
- Tap to return to step 6.

8 Tap the last image (thumbnail) of the range to be copied.



- If there are images you don't want to copy, tap the image (thumbnail) to remove ✓.

9 After selecting all the files, tap "SAVE".

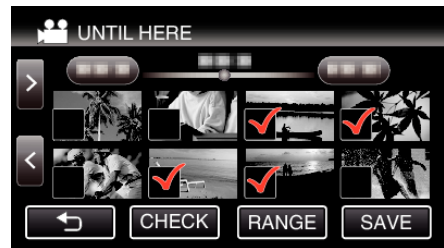

10 Tap "EXECUTE".



- The number of discs required to copy the files is displayed. Prepare the discs accordingly.

11 Tap "AUTO" or "BY DATE". (mode only)

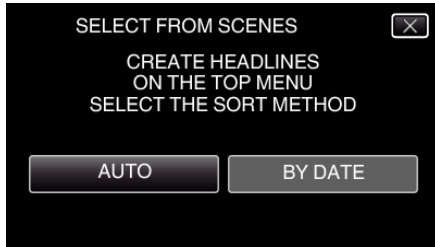

- When "AUTO" is selected, videos with similar recording dates are displayed in groups.
- When "BY DATE" is selected, videos are displayed according to recording dates.

12 Tap "EXECUTE".



- When "INSERT THE NEXT DISC TO CREATE OR PRESS STOP TO EXIT" appears, change the disc.

13 Tap "OK" when "COMPLETED" is displayed.

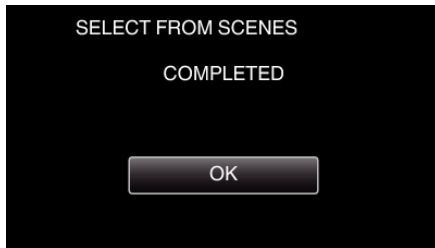

14 Close the LCD monitor of this unit to turn off this unit and disconnect the USB cable.

Caution :

- If you copy many images at once, it may not be possible to create the disc halfway through the process. If the volume of the image data is large, copy the data in several times.
- Do not turn off the power or remove the USB cable until copying is complete.
- Files that are not on the index screen during playback cannot be copied. Special files cannot be copied either.
- All DVDs will be finalized automatically. While files cannot be added to the DVD-R/DVD-RW later, files can still be added to the BD-R/BD-RE.
- If the created BD-R/BD-RE is played back on a Blu-ray recorder, your Blu-ray recorder may disable additional recording on the BD-R/BD-RE. In this case, files cannot be added to the disc.
- If you stop the process of creating the disc at the screen for creating disc, the disc in use for writing cannot be used again.
- DVDs that are created in "DVD(AVCHD)" format are playable only on AVCHD compatible devices.
- Videos that are recorded in the 50p mode (when "SYSTEM SELECT" is set to "50p") can only be copied to Blu-ray discs. And 200 videos can be copied onto one disc.
- Blu-ray discs containing videos that are recorded in the 50p mode (when "SYSTEM SELECT" is set to "50p") are playable only on AVCHD Progressive compatible devices.
- Videos recorded in "UXP" video quality cannot be copied to DVDs (AVCHD format). Copy to a BD.

Memo :

- To check the created disc, refer to "Playing Back with a BD Writer (External Blu-ray Drive)" (p. 75).

"Playing Back with a BD Writer (External Blu-ray Drive)" (p. 75)

Playing Back with a BD Writer (External Blu-ray Drive)

You can play back the Blu-ray discs created on this unit.

"Preparing a BD Writer (External Blu-ray Drive)" (p. 68)

1 Connect this unit to the BD writer and TV.

(If this unit is not connected to a TV, images can be played back on the LCD monitor of this unit.)

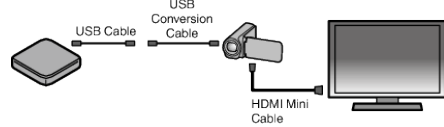

"Preparing a BD Writer (External Blu-ray Drive)" (p. 68)

"Connecting to and Viewing on TV" (p. 58)

- Insert a disc to play back into the BD writer.

2 Tap "PLAYBACK" in the "BACK-UP" menu.

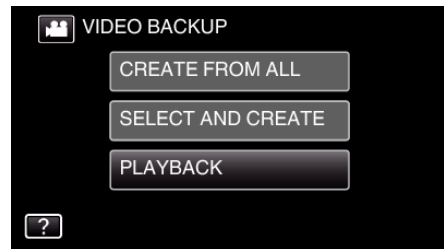

- An index screen (thumbnail display) of the videos in the disc appears.
- Tap the icon to switch between the video and still image modes.

3 Tap on the file to start playback.

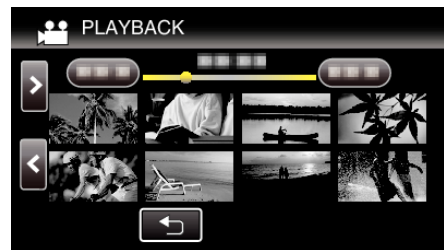

- For details on video playback, refer to "Operation Buttons for Video Playback" (p. 50).

"Operation Buttons for Video Playback" (p. 50)

- To exit playback, stop playback and close the LCD monitor to turn off this unit. Then, disconnect the USB cable.

Memo :

- When playing back DVD-Video discs, date/time and other information will not be displayed on the screen.
- To play back the recorded image on TV, connect this unit via the HDMI mini cable or the AV cord while this unit is connected to the BD writer (external Blu-ray drives).

"Connecting via the HDMI Mini Connector" (p. 58)

"Connecting via the AV Connector" (p. 60)

Creating Discs with a DVD Writer

You can copy the recorded files to discs or play back the created discs using an optional DVD writer.

Creating Discs with a DVD Writer

■ Preparing a DVD Writer

“Preparing a DVD Writer (CU-VD3)” (☞ p. 76)

“Preparing a DVD Writer (CU-VD50)” (☞ p. 77)

■ Copying to Discs

“Copying All Files” (☞ p. 78)

“Copying Selected Playlists” (☞ p. 79)

“Copying Selected Files” (☞ p. 80)

■ Other Operations

“Playing Back with a DVD Writer” (☞ p. 83)

Memo :

- Discs created on this unit are saved in the AVCHD format. Play back on an AVCHD compatible device (such as Blu-ray recorder).
- Images recorded in UXP mode cannot be copied to a DVD writer.
- You cannot create a disc if the remaining battery power is not enough. Charge this unit fully beforehand.
- If you copy many images at once, it may not be possible to create the disc halfway through the process. If the volume of the image data is large, copy the data in several times.
- When backing up the files, it may take time for the backup to be completed. Wait for a while as the POWER/ACCESS lamp appears blinking, which indicates normal operation.
- Date and time information as saved as subtitles in the created discs.

Preparing a DVD Writer (CU-VD3)

- 1 Open the terminal cover.
- 2 Connect the USB cable and the AC adapter of the DVD writer.
 - Before making any connection, close the LCD monitor to turn off this unit.

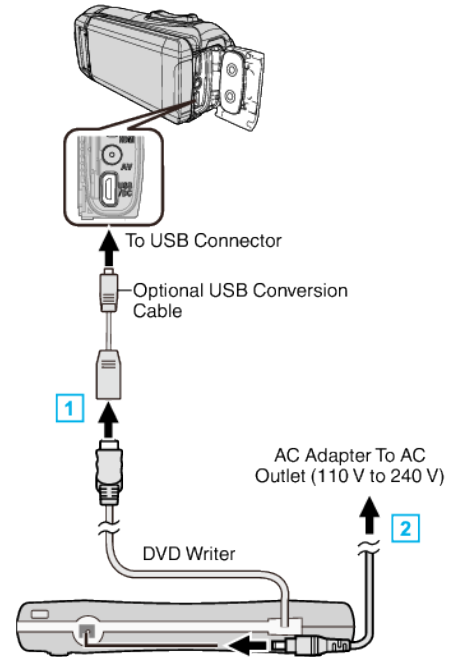

- 1 Connect the USB cable provided with the DVD writer to the optional USB conversion cable to connect to this unit.
- 2 Connect the AC adapter of the DVD writer.

- 3 Open the LCD monitor.

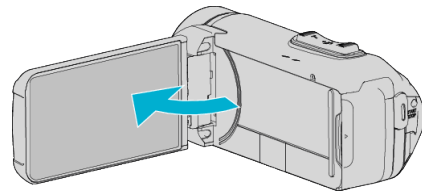

- This unit turns on and the “BACK-UP” menu appears.
- While the USB cable is connected, the “BACK-UP” menu is displayed.

- 4 Insert a new disc.

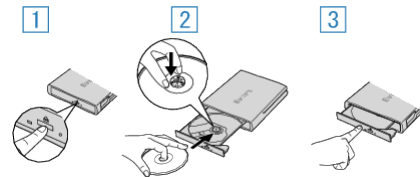

- 1 Press the eject button to open the disc tray.
- 2 Pull out the tray completely and load a new disc properly.
- 3 Push the disc tray in until it clicks into place.

Caution :

- Be sure to turn off the power when connecting the devices. Otherwise, electric shocks or malfunctions may occur.

Memo :

- When connecting this unit to the DVD writer, purchase the following USB conversion cable (optional).
Part number: QAM1588-001 * Micro AB (Male) – Mini AB (Female)
* Consult your nearest service center.

Preparing a DVD Writer (CU-VD50)

- 1 Open the terminal cover.
- 2 Connect the USB cable and the AC adapter of the DVD writer.
 - Before making any connection, close the LCD monitor to turn off this unit.

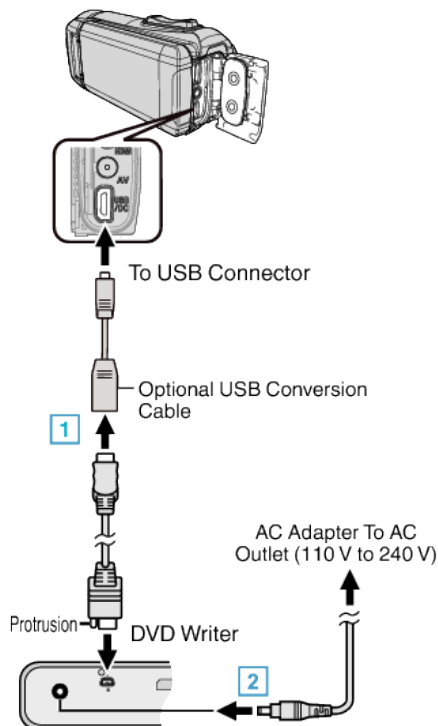

- 1 Connect the USB cable provided with the DVD writer to the optional USB conversion cable to connect to this unit.
- 2 Connect the AC adapter of the DVD writer.

- Turn on the DVD writer.
 - Refer also to the instruction manual of the DVD writer.

- 3 Open the LCD monitor.

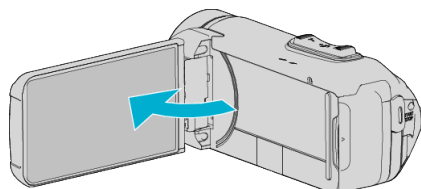

- This unit turns on and the "BACK-UP" menu appears.
- While the USB cable is connected, the "BACK-UP" menu is displayed.

- 4 Insert a new disc.



- 1 Press the eject button.
- 2 Pull out the disc tray.
- 3 Pull out the tray completely and load a new disc properly.
- 4 Push the disc in until it clicks into place.

Caution :

- Be sure to turn off the power when connecting the devices. Otherwise, electric shocks or malfunctions may occur.

Memo :

- All buttons on the DVD writer CU-VD50, other than the power and eject buttons, will not work when connected to this unit.
- When connecting this unit to the DVD writer, purchase the following USB conversion cable (optional).
Part number: QAM1588-001 * Micro AB (Male) – Mini AB (Female)
* Consult your nearest service center.

Creating a Disc

Caution :

- You cannot create a disc if the remaining battery power is not enough. Charge this unit fully beforehand.

- 1 Prepare a DVD writer.
 - Insert a new disc into the DVD writer.
"Preparing a DVD Writer (CU-VD3)" (p. 76)
"Preparing a DVD Writer (CU-VD50)" (p. 77)
- 2 Copy files to the disc with the following methods.
"Copying All Files" (p. 78)
"Copying Selected Playlists" (p. 79)
"Copying Selected Files" (p. 80)

Copying

Copying All Files

All videos or still images recorded on this unit will be copied. You can also select and copy only the videos or still images that have never been copied.

- 1 Select video or still image mode.
- 2 Tap "CREATE FROM ALL" (video) or "SAVE ALL" (still image).



- While the video mode is shown in the image, the same operations apply for the still image mode.
- Tap  to switch between the video and still image modes.

- 3 Tap the media you would like to make a backup.



- 4 Tap the desired method.

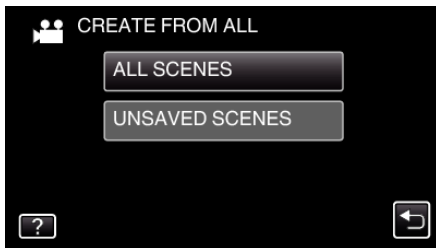

- While the video mode is shown in the image, the same operations apply for the still image mode.
- **"ALL SCENES" (video)/"ALL IMAGES" (still image):**
All videos or still images in this unit are copied.
- **"UNSAVED SCENES" (video)/"UNSAVED IMAGES" (still image):**
Videos or still images that have never been copied are automatically selected and copied.

- 5 Tap "EXECUTE".



- The number of discs required to copy the files is displayed. Prepare the discs accordingly.

- 6 Tap "AUTO" or "BY DATE". ( mode only)



- When "AUTO" is selected, videos with similar recording dates are displayed in groups.
- When "BY DATE" is selected, videos are displayed according to recording dates.

- 7 Tap "EXECUTE".



- When "INSERT THE NEXT DISC TO CREATE OR PRESS STOP TO EXIT" appears, change the disc.

- 8 Tap "OK" when "COMPLETED" is displayed.

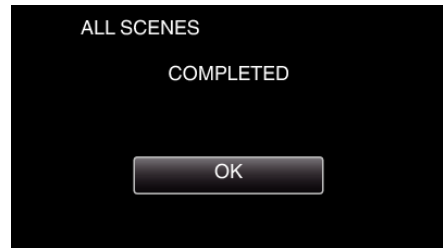

- 9 Close the LCD monitor of this unit to turn off this unit and disconnect the USB cable.

Caution :

- If you copy many images at once, it may not be possible to create the disc halfway through the process. If the volume of the image data is large, copy the data in several times.
- Do not turn off the power or remove the USB cable until copying is complete.
- Files that are not on the index screen during playback cannot be copied. Special files cannot be copied either.
- All DVDs will be finalized automatically. Files cannot be added to the DVD-R/DVD-RW later.
- If you stop the process of creating the disc at the screen for creating disc, the disc in use for writing cannot be used again.
- DVDs that are created in "DVD(AVCHD)" format are playable only on AVCHD compatible devices.
- Videos recorded in "UXP" video quality or videos recorded in 50p mode ("SYSTEM SELECT" is set to "50p") cannot be copied to DVDs (AVCHD format). Copy to a BD.

Memo :

- To check the created disc, refer to "Playing Back with a DVD Writer" (p. 83).

"Playing Back with a DVD Writer" (p. 83)

Copying Selected Playlists

Arrange and copy the created playlists in the order you like.

- 1 Select video mode.
- 2 Tap "SELECT AND CREATE".



- 3 Tap "DVD(AVCHD)" or "DVD-Video".



- The media changes to the tapped item. Select the appropriate setting according to the disc.
- Selecting "DVD(AVCHD)" enables you to save videos in a DVD in the high definition quality.

- 4 Tap the media you would like to make a backup.



- 5 Tap "CREATE BY PLAYLIST".

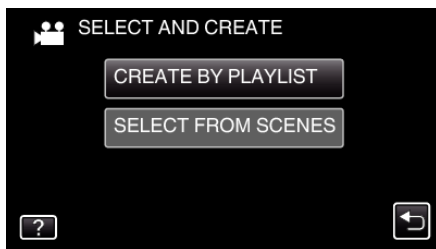

- 6 Tap on the playlist to copy to disc.

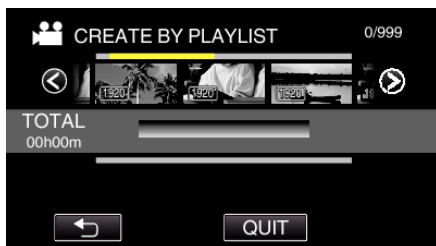

- ▶ appears on the selected playlist (upper row). Tap ↵ to deselect.
- Tap on the selected playlist again to check the content of the playlist. After checking, tap ↵.
- Tap </> or move the zoom lever to display the previous/next playlist.

- 7 Tap "ADD" to insert a playlist.

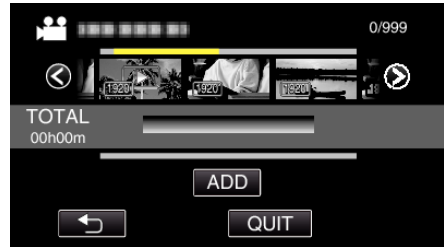

- Repeat steps 6-7 and arrange the playlists.
- To change the position of a playlist (lower row), select the insertion point with ←/→ after step 6 and tap "ADD".
- ▶ appears when the inserted playlist is selected. Tap ↵ to deselect.
- Tap on the selected playlist again to check the content of the playlist. After checking, tap ↵.
- To delete of a video in the playlist (lower row), tap the video, then tap "CANCEL".

- 8 After arranging, tap "SAVE".

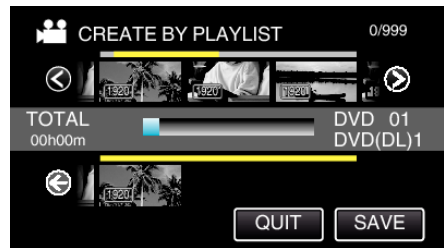

- 9 Tap "EXECUTE".

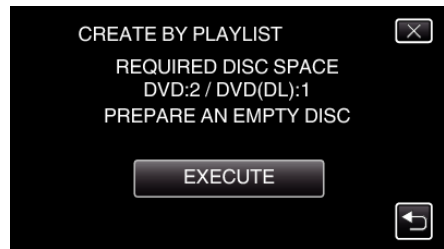

- The number of discs required to copy the files is displayed. Prepare the discs accordingly.
- Tap "CHECK" to check the content. After checking, tap ↵.

- 10 Tap "OK".

- If step 10 is not displayed, go to step 11.

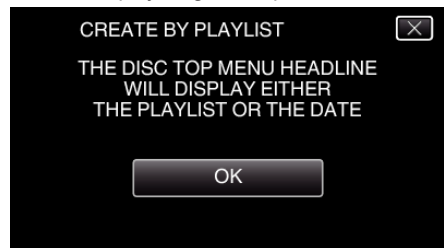

Alternatively, tap "AUTO" or "BY DATE".

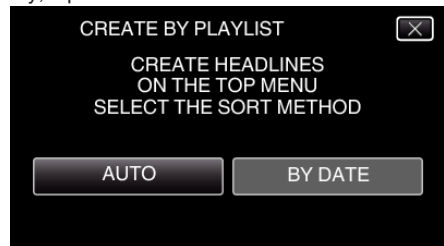

- When "AUTO" is selected, videos with similar recording dates are displayed in groups.
- When "BY DATE" is selected, videos are displayed according to recording dates.

- 11 Tap "EXECUTE".

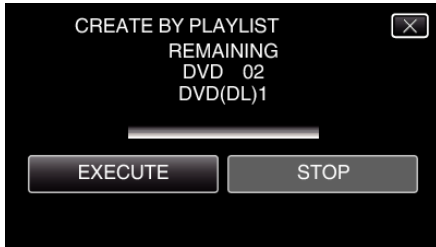

- When "INSERT THE NEXT DISC TO CREATE OR PRESS STOP TO EXIT" appears, change the disc.

12 Tap "OK" when "COMPLETED" is displayed.

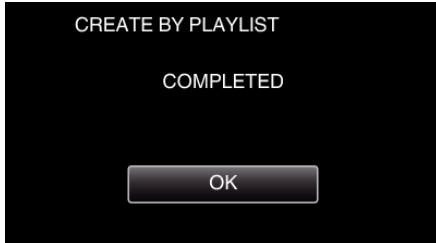

13 Close the LCD monitor of this unit to turn off this unit and disconnect the USB cable.

Caution :

- If you copy many images at once, it may not be possible to create the disc halfway through the process. If the volume of the image data is large, copy the data in several times.
- Do not turn off the power or remove the USB cable until copying is complete.
- Files that are not on the index screen during playback cannot be copied. Special files cannot be copied either.
- All DVDs will be finalized automatically. Files cannot be added to the DVD-R/DVD-RW later.
- If you stop the process of creating the disc at the screen for creating disc, the disc in use for writing cannot be used again.
- DVDs that are created in "DVD(AVCHD)" format are playable only on AVCHD compatible devices.
- Videos recorded in "UXP" video quality or videos recorded in 50p mode ("SYSTEM SELECT" is set to "50p") cannot be copied to DVDs (AVCHD format). Copy to a BD.

Memo :

- A list of playlists is displayed on the top menu of the created DVD.
- To check the created disc, refer to "Playing Back with a DVD Writer" (p. 83).

"Playing Back with a DVD Writer" (p. 83)

Copying Selected Files

Select and copy the desired videos or still images individually. There are 2 ways to select images.

- Selecting Files One by One
- Specify a "FROM HERE" to "UNTIL HERE" range.

■ Copying Selected Files One by One

- 1 Select video or still image mode.
- 2 Tap "SELECT AND CREATE" (video) or "SELECT AND SAVE" (still image).

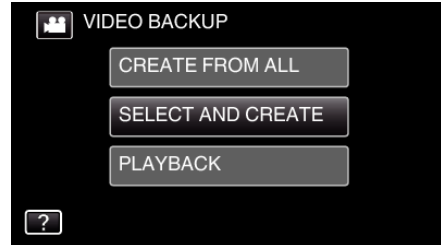

- While the video mode is shown in the image, the same operations apply for the still image mode.
- Tap to switch between the video and still image modes.

3 Tap "DVD(AVCHD)" or "DVD-Video".



- The media changes to the tapped item. Select the appropriate setting according to the disc.
- Selecting "DVD(AVCHD)" enables you to save videos in a DVD in the high definition quality.

4 Tap the media you would like to make a backup.

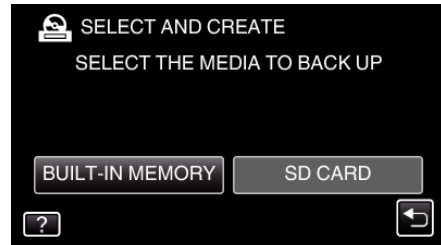

5 Tap "SELECT FROM SCENES" (video) or "SELECT FROM IMAGES" (still image).

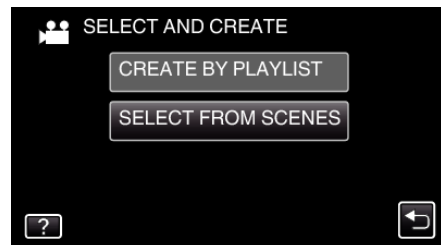

- While the video mode is shown in the image, the same operations apply for the still image mode.

6 Tap on the videos or still images to copy.

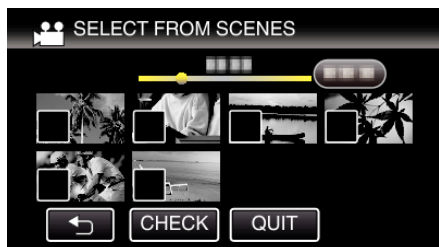

- ✓ appears on the selected files.
To remove ✓ from a file, tap on the file again.
- Tap "CHECK" to check the file.
After checking, tap ↩.
- While the video mode is shown in the image, the same operations apply for the still image mode.

7 After selecting all the files, tap "SAVE".

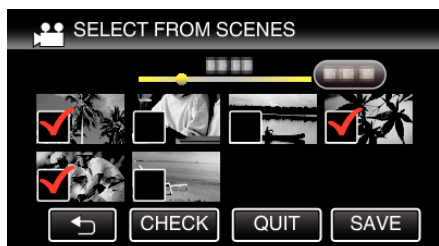

- While the video mode is shown in the image, the same operations apply for the still image mode.

8 Tap "EXECUTE".

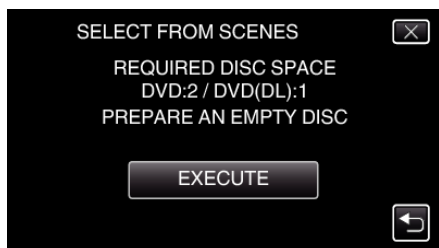

- The number of discs required to copy the files is displayed.
Prepare the discs accordingly.

9 Tap "AUTO" or "BY DATE". (👤 mode only)

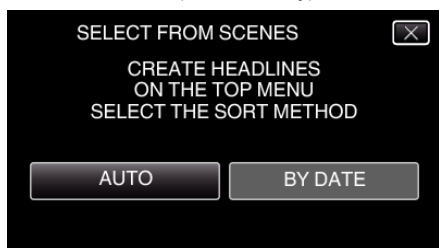

- When "AUTO" is selected, videos with similar recording dates are displayed in groups.
- When "BY DATE" is selected, videos are displayed according to recording dates.

10 Tap "EXECUTE".



- When "INSERT THE NEXT DISC TO CREATE OR PRESS STOP TO EXIT" appears, change the disc.

11 Tap "OK" when "COMPLETED" is displayed.

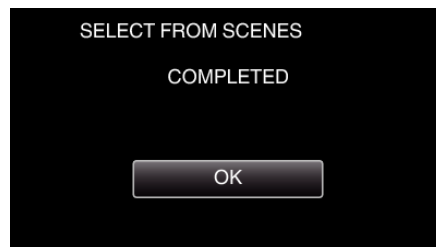

12 Close the LCD monitor of this unit to turn off this unit and disconnect the USB cable.

■ Specify the range to copy the files.

1 Select video mode.

2 Tap "SELECT AND CREATE".

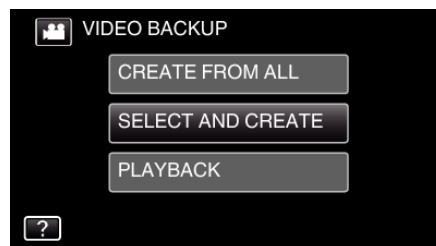

3 Tap "DVD(AVCHD)" or "DVD-Video".



- The media changes to the tapped item. Select the appropriate setting according to the disc.
- Selecting "DVD(AVCHD)" enables you to save videos in a DVD in the high definition quality.

4 Tap the media you would like to make a backup.

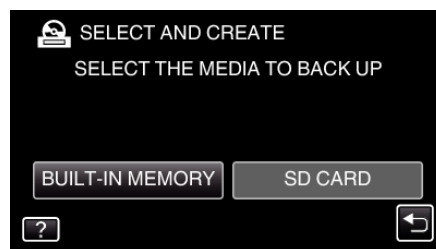

5 Tap "SELECT FROM SCENES" (video) or "SELECT FROM IMAGES" (still image).

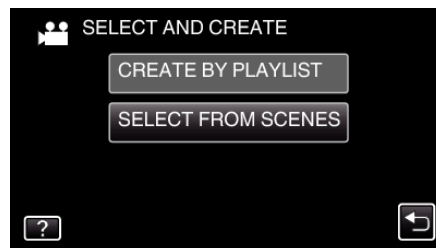

- While the video mode is shown in the image, the same operations apply for the still image mode.

6 Tap "RANGE".

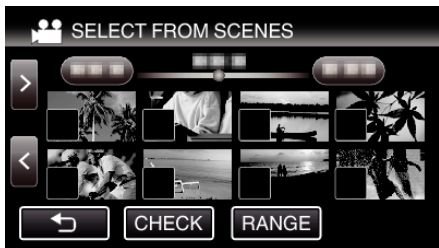

7 Tap the first image (thumbnail) of the range to be copied.

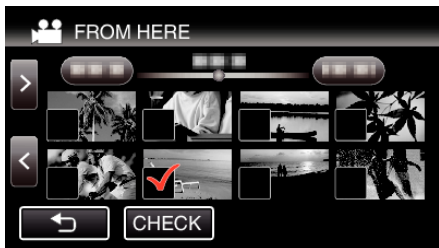

- ✓ is added to all the files to be copied when “CHECK” is tapped.
- Tap ↶ to return to step 6.

8 Tap the last image (thumbnail) of the range to be copied.

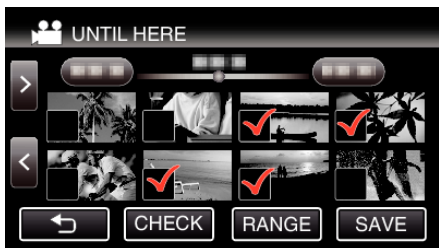

- If there are images you don't want to copy, tap the image (thumbnail) to remove ✓.

9 After selecting all the files, tap “SAVE”.

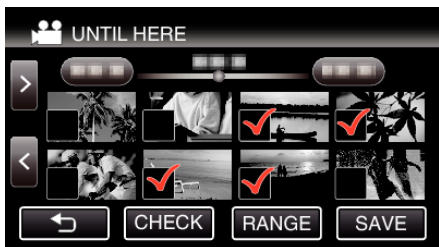

10 Tap “EXECUTE”.



- The number of discs required to copy the files is displayed. Prepare the discs accordingly.

11 Tap “AUTO” or “BY DATE”. (👤 mode only)

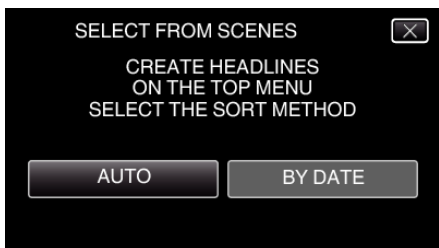

- When “AUTO” is selected, videos with similar recording dates are displayed in groups.

- When “BY DATE” is selected, videos are displayed according to recording dates.

12 Tap “EXECUTE”.



- When “INSERT THE NEXT DISC TO CREATE OR PRESS STOP TO EXIT” appears, change the disc.

13 Tap “OK” when “COMPLETED” is displayed.

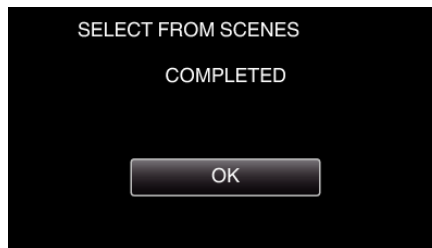

14 Close the LCD monitor of this unit to turn off this unit and disconnect the USB cable.

Caution :

- If you copy many images at once, it may not be possible to create the disc halfway through the process. If the volume of the image data is large, copy the data in several times.
- Do not turn off the power or remove the USB cable until copying is complete.
- Files that are not on the index screen during playback cannot be copied. Special files cannot be copied either.
- All DVDs will be finalized automatically. Files cannot be added to the DVD-R/DVD-RW later.
- If you stop the process of creating the disc at the screen for creating disc, the disc in use for writing cannot be used again.
- DVDs that are created in “DVD(AVCHD)” format are playable only on AVCHD compatible devices.
- Videos recorded in “UXP” video quality or videos recorded in 50p mode (“SYSTEM SELECT” is set to “50p”) cannot be copied to DVDs (AVCHD format). Copy to a BD.

Memo :

- To check the created disc, refer to ““Playing Back with a DVD Writer” (p. 83) ”.
- “Playing Back with a DVD Writer” (p. 83)

Playing Back with a DVD Writer

You can play back the DVDs created on this unit.

- 1 Connect this unit to the DVD writer and TV.
(If this unit is not connected to a TV, images can be played back on the LCD monitor of this unit.)

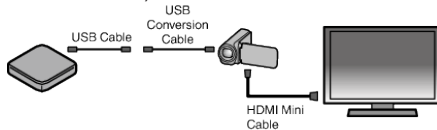

“Preparing a DVD Writer (CU-VD3)” (p. 76)

“Preparing a DVD Writer (CU-VD50)” (p. 77)

“Connecting to and Viewing on TV” (p. 58)

- Insert the DVD to play back into the DVD writer.

- 2 Tap “PLAYBACK” in the “BACK-UP” menu.



- An index screen (thumbnail display) of the videos in the disc appears.
- Tap the icon to switch between the video and still image modes.

- 3 Tap on the file to start playback.

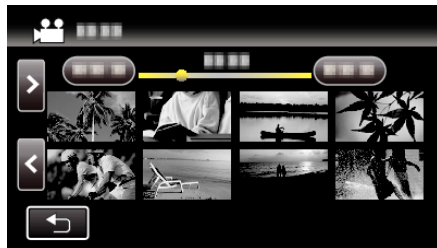

- Tap “↶” to return to the “BACK-UP” menu.
- For details on video playback, refer to “Operation Buttons for Video Playback” (p. 50).
- “Operation Buttons for Video Playback” (p. 50)
- To exit playback, stop playback and close the LCD monitor to turn off this unit. Then, disconnect the USB cable.

Memo :

- When playing back DVD-Video discs, date/time and other information will not be displayed on the screen.
 - To play back the recorded image on TV, connect this unit via the HDMI mini cable or the AV Cord while this unit is connected to the DVD writer.
- “Connecting via the HDMI Mini Connector” (p. 58)
 “Connecting via the AV Connector” (p. 60)

Dubbing Files to a Disc by Connecting to a Blu-ray Recorder

You can dub videos in the high definition quality by connecting an AVCHD-compliant Blu-ray recorder to this unit via a USB cable. For details on creating the disc, refer to the instruction manual of your Blu-ray recorder.

- This operation cannot be completed if the remaining battery power is not enough. Charge the battery fully first.

- 1 Open the terminal cover.
- 2 Connect to a Blu-ray recorder.
 - Connect using the USB cable provided with this unit.
 - Before making any connection, close the LCD monitor to turn off this unit.

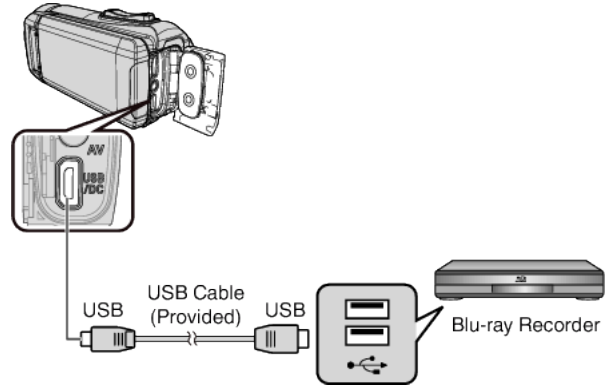

- 3 Open the LCD monitor.

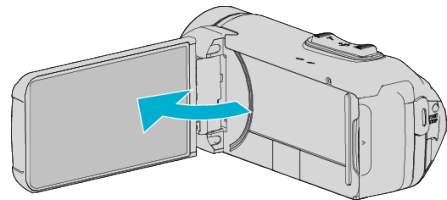

- This unit turns on and the “SELECT DEVICE” screen appears.

- 4 Tap “CONNECT TO OTHER”.



- 5 Tap the desired media.

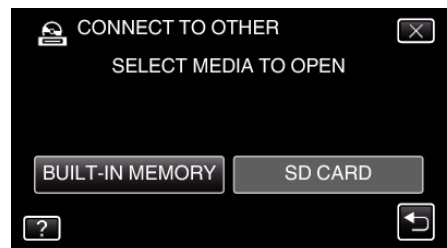

- The following screen is displayed after the camera operation is completed.



- Operations are to be performed on the Blu-ray recorder after the screen switches.

6 Perform dubbing on the Blu-ray recorder.

- Refer also to the instruction manual of the Blu-ray recorder.
- After dubbing is complete, close the LCD monitor of this unit and check that the POWER/ACCESS lamp goes off before disconnecting the USB cable. Operations cannot be performed on this unit until the USB cable is disconnected.

Memo :

- To copy videos that are recorded in the 50p mode (when "SYSTEM SELECT" is set to "50p"), use an AVCHD Progressive compatible Blu-ray recorder.
- Videos that are recorded in the 50p mode (when "SYSTEM SELECT" is set to "50p") can only be copied to Blu-ray discs.

Dubbing Files to a Disc by Connecting to a DVD Recorder

You can dub videos in standard quality by connecting to a DVD recorder.

- Refer also to the instruction manuals of the TV and DVD recorder.

1 Open the terminal cover.

2 Connect to a DVD recorder.

- Before making any connection, close the LCD monitor to turn off this unit.

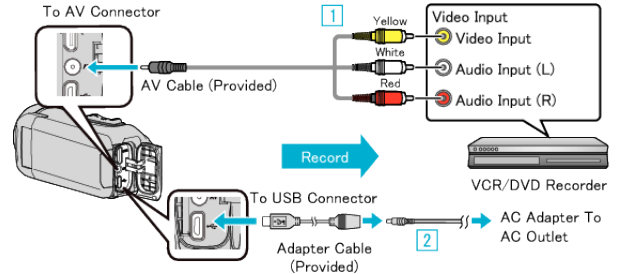

1 Connect using the optional AV cable.

2 Connect the adapter cable and AC adapter to this unit.

3 Open the LCD monitor.

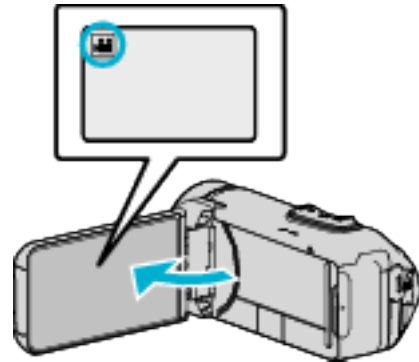

- Check if the recording mode is .
- If the mode is still image, tap on the recording screen to display the mode switching screen. Tap to switch the mode to video.

4 Tap <<PLAY to select the playback mode.

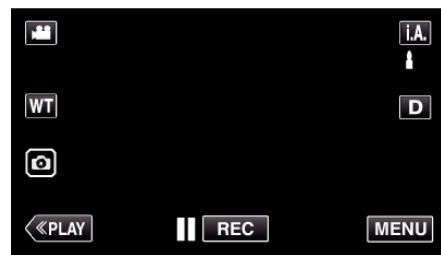

5 Prepare the TV/DVD recorder for recording.

- Switch to a compatible external input.
- Insert a disc (DVD-R, etc.) into the DVD recorder.

6 Prepare this unit for playback.

- Set "VIDEO OUTPUT" in the "CONNECTION SETTINGS" menu to the aspect ratio ("4:3" or "16:9") of the connecting TV. "VIDEO OUTPUT" (p. 164)

7 Start recording.

- Start playback on this unit and press the record button on the recorder.

"Playing Back Videos" (p. 49)

- After playback is complete, stop the recording.

Memo :

- AV cable (provided: QAM1322-001)

Before using the cable, attach the core filter provided with this unit.
 “Attaching the Core Filter” (p. 10)

Wiring specifications (for video/audio) of the 4-pole mini plug are described in the following.

To purchase, consult your nearest JVC service center.

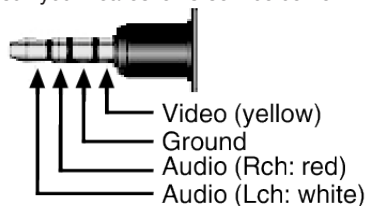

Memo :

- To include the recording date and time during dubbing, set “DISPLAY DATE/TIME” in the “PLAYBACK SETTING” menu to “ON”. Or, set “DISPLAY ON TV” in the “CONNECTION SETTINGS” menu to “ON”.

Dubbing Files to a VHS Tape by Connecting to a VCR

You can dub videos in standard quality by connecting to a VCR.

- Refer also to the instruction manuals of the TV and VCR.

- 1 Open the terminal cover.
- 2 Connect to a VCR/DVD recorder.
 - Before making any connection, close the LCD monitor to turn off this unit.

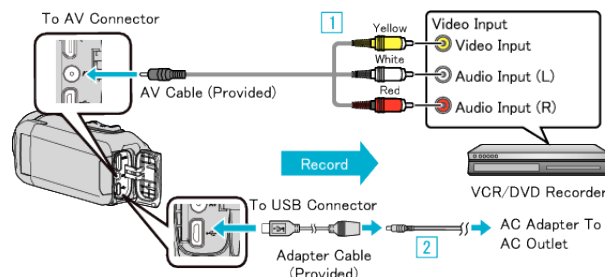

- 1 Connect using the optional AV cable.
- 2 Connect the adapter cable and AC adapter to this unit.
 - Be sure to use the supplied AC adapter.

- 3 Open the LCD monitor.

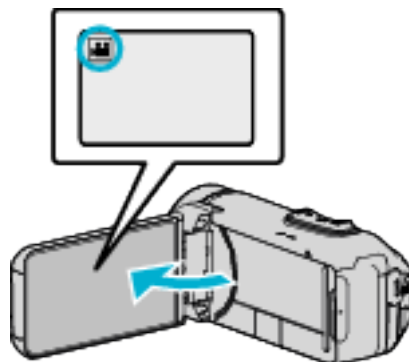

- Check if the recording mode is .
- If the mode is still image, tap on the recording screen to display the mode switching screen. Tap to switch the mode to video.

- 4 Tap **<<PLAY** to select the playback mode.

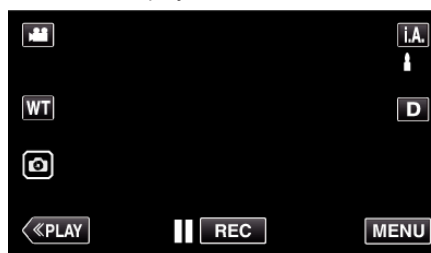

- 5 Prepare the TV/VCR for recording.
 - Switch to a compatible external input.
 - Insert a video tape.
- 6 Prepare this unit for playback.
 - Set “VIDEO OUTPUT” in the “CONNECTION SETTINGS” menu to the aspect ratio (“4:3” or “16:9”) of the connecting TV. “VIDEO OUTPUT” (p. 164)
- 7 Start recording.
 - Start playback on this unit and press the record button on the recorder.
 - “Playing Back Videos” (p. 49)
 - After playback is complete, stop the recording.

Memo : _____

- AV cable (provided: QAM1322-001)

Before using the cable, attach the core filter provided with this unit.

“Attaching the Core Filter” (☞ p. 10)

Wiring specifications (for video/audio) of the 4-pole mini plug are described in the following.

To purchase, consult your nearest JVC service center.

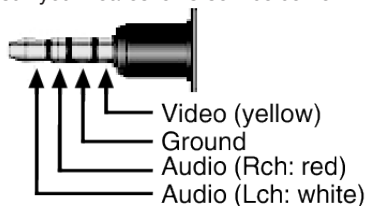

Memo : _____

- To include the recording date and time during dubbing, set “DISPLAY DATE/TIME” in the “PLAYBACK SETTING” menu to “ON”. Or, set “DISPLAY ON TV” in the “CONNECTION SETTINGS” menu to “ON”.

Using a USB External Hard Disk Drive

You can copy video and still image files to a USB external hard disk drive from this unit. You can also play the files in the USB external hard disk drive on this unit.

- This operation cannot be completed if the remaining battery power is not enough. Charge the battery fully first.
- Refer also to the instruction manual of the external hard disk drive.

Compatible External Hard Disk Drives

You can use the “LaCie Hard Disk Sleek black design USB2.0” series from LaCie.

Memo : _____

Before purchasing, check the compatible devices on the LaCie website.

- LaCie
<http://www.lacie.com/home.htm?cc=1>
- USB external hard disk drives up to 2 TB can be used.

Copying and Playback with a USB External Hard Disk Drive

“Preparing a USB External Hard Disk Drive” (☞ p. 87)

“Copying All Files” (☞ p. 87)

“Playing Back Files in the USB External Hard Disk Drive” (☞ p. 88)

“Deleting Folders in the USB External Hard Disk Drive” (☞ p. 89)

Importing Files from the USB External Hard Disk Drive

“Importing Files from the USB External Hard Disk Drive” (☞ p. 90)

Memo : _____

- Format the USB external hard disk drive when connecting it to this unit for the first time. (All data will be deleted.)
- “Formatting the USB External Hard Disk Drive” (☞ p. 89)
- Refer to the help file of the provided Everio MediaBrowser 4 software when you use the PC to operate the data in the USB external hard disk drive directly copied from this unit.
- “Trouble with Using the Provided Software Everio MediaBrowser 4” (☞ p. 92)
- USB external hard disk drives with the capacity over 2 TB cannot be used.
 - Copying may take time. (For example, saving 1 hour video in XP mode takes about 20 minutes.)
 - Wait for a while as the POWER/ACCESS lamp appears blinking, which indicates normal operation.
 - If you copy many images at once, copying may not be completed. If the volume of the image data is large, copy the data in several times.
 - Sound or video may be interrupted during playback.

Caution : _____

- Do not connect a USB hub between this unit and the USB external hard disk drive.
- Disconnect the USB external hard disk drive when using other USB devices such as DVD writer, external Blu-ray drive, or another USB external hard disk drive.
- Avoid the following operations during copying and playing back. - Turning off the unit or the USB external hard disk drive. - Disconnecting the USB cable.
- Do not format the USB external hard disk drive using the PC. If you did, format again using this unit. (All the data in the USB external hard disk drive will be erased.)
- Avoid the following operations using the PC. - Deleting files or folders in the USB external hard disk drive. - Moving files or folders in the USB external hard disk drive. - Changing the name of files or folders in the USB external hard disk drive.
These operations make the data impossible to be played back on this unit.
- When you use the PC to edit the data in the USB external hard disk drive, copy the data to the PC before editing. Editing the data in the USB external hard disk drive directly from the PC makes the data impossible to be played back on this unit.

Preparing a USB External Hard Disk Drive

Caution :

- This operation cannot be completed if the remaining battery power is not enough. Charge the battery fully first.

Memo :

- When connecting to the external hard disk drive, use a USB cable (commercially available) indicated below. The USB cable provided with this unit cannot be used.
- Please prepare a USB cable that is suitable for your product. An optional USB conversion cable (QAM1588-001: Mini AB Female - Micro A Male) may be used in conjunction with our optional USB conversion cable (QAM0852-001: A Female - Mini B Male).
- *To purchase, consult your nearest JVC service center.

- 1 Open the terminal cover.
- 2 Connect using the optional AV cable.
- 3 Connect the USB cable and the AC adapter of the USB external hard disk drive.
 - Before making any connection, close the LCD monitor to turn off this unit.

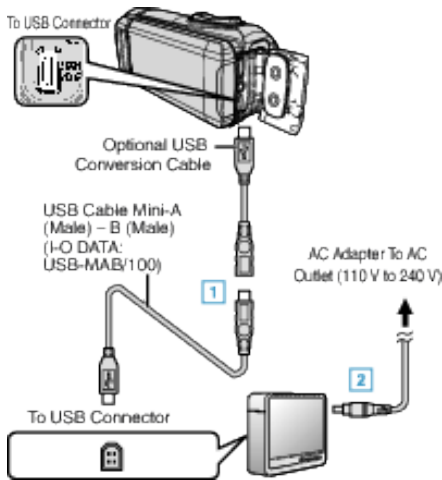

- 1 Connect the USB cable with the USB external hard disk drive.
 - 2 Connect the AC adapter of the USB external hard disk drive.
- Turn on the external hard disk drive.
 - Refer also to the instruction manual of the external hard disk drive.
- 4 Open the LCD monitor.

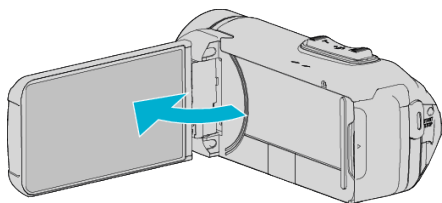

- This unit turns on and the “BACK-UP” menu appears.
- While the USB cable is connected, the “BACK-UP” menu is displayed.

Caution :

- Be sure to turn off the power when connecting the devices. Otherwise, electric shocks or malfunctions may occur.
- Do not connect a USB hub between this unit and the USB external hard disk drive.

Copying All Files

All videos or still images recorded on this unit will be copied. You can also select and copy only the videos or still images that have never been copied.

- 1 Select video or still image mode.
- 2 Tap “BACK UP”.

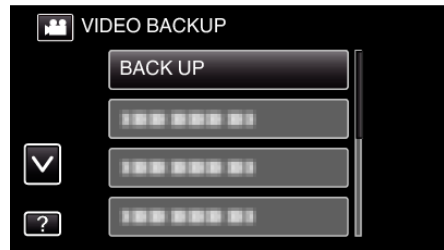

- While the video mode is shown in the image, the same operations apply for the still image mode.
- Tap the icon to switch between the video and still image modes.

- 3 Tap the media you would like to make a backup.

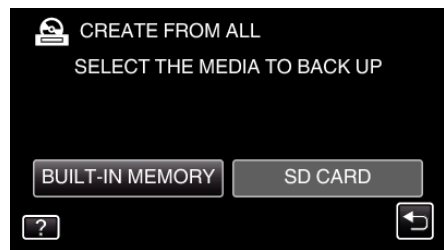

- 4 Tap the desired method.

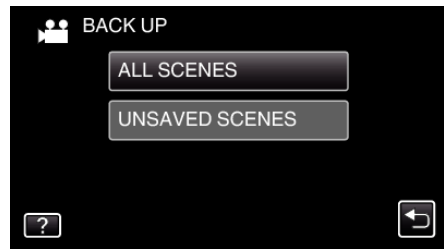

- “ALL SCENES” (video)/“ALL IMAGES” (still image): All videos or still images in this unit are copied.
- “UNSAVED SCENES” (video)/“UNSAVED IMAGES” (still image): Videos or still images that have never been copied are automatically selected and copied.

- 5 Check that there is sufficient remaining space on the hard disk drive and tap “YES”.



- Backup starts when “YES” is tapped.

- 6 Tap "OK" when "COMPLETED" is displayed.

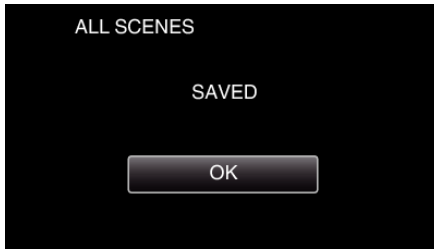

- 7 Close the LCD monitor of this unit to turn off this unit and disconnect the USB cable.

Caution :

- Do not turn off the power or remove the USB cable until copying is complete.
- Files that are not on the index screen during playback cannot be copied. Special files cannot be copied either.
- Copying may take time. (For example, saving 1 hour video in XP mode takes about 20 minutes.)

Playing Back Files in the USB External Hard Disk Drive

Videos or still images saved in an external hard disk drive can be played back on this unit.

- This operation cannot be performed if the remaining battery power is not enough. Charge this unit fully beforehand.

- 1 Tap "PLAYBACK".

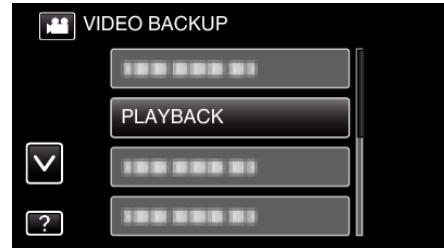

- 2 Select video or still image mode.

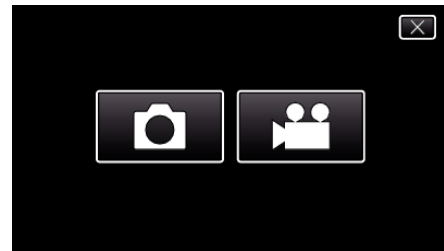

- If step 2 is not displayed, go to step 3.
- If the backup files of video or still image are not made, these icons won't be displayed.

- 3 Tap on the folder to play back.

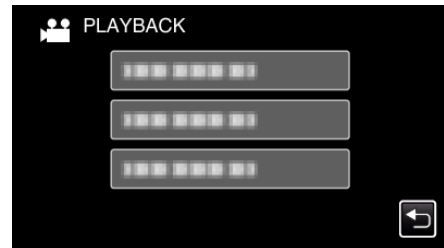

- Tap "←" to return to the "BACK-UP" menu.

- 4 Tap on the file to play back.



- Tap "←" to return to the folder index screen.
- For details on video playback, refer to "Operation Buttons for Video Playback" (p. 50).

"Operation Buttons for Video Playback" (p. 50)

- To exit playback, stop playback and close the LCD monitor to turn off this unit. Then, disconnect the USB cable.

Memo :

- Sound or video may be interrupted during playback.

Deleting Folders in the USB External Hard Disk Drive

Files that are copied to the external hard disk drive can be deleted.

Caution :

- Deleted files cannot be restored.
- Be sure to back up important files on a PC. "Backing Up All Files" (p. 97)

- 1 Select video or still image mode.
- 2 Tap "DELETE".



- While the video mode is shown in the image, the same operations apply for the still image mode.
- Tap the icon to switch between the video and still image modes.

- 3 Tap on the folder to delete.

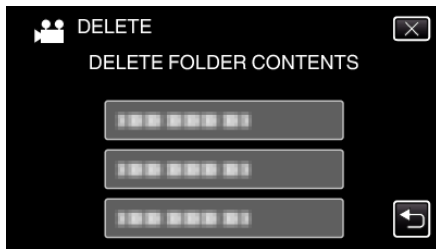

- 4 Tap "YES".

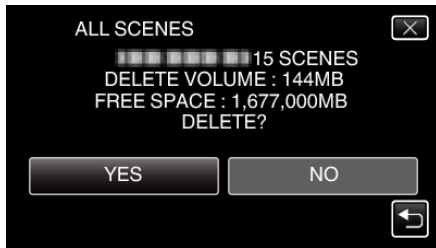

- After deleting, tap "OK".

Formatting the USB External Hard Disk Drive

All files on the external hard disk drive can be deleted.

- This operation cannot be performed if the remaining battery power is not enough. Charge this unit fully beforehand.

Caution :

- All data on the external hard disk drive will be deleted when it is formatted. Copy all files on the external hard disk drive to a computer before formatting.

- 1 Select video or still image mode.
- 2 Tap "FORMAT".

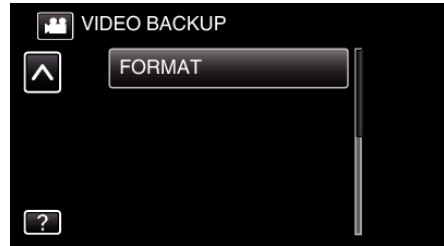

- While the video mode is shown in the image, the same operations apply for the still image mode.
- Tap the icon to switch between the video and still image modes.

- 3 Tap "YES".

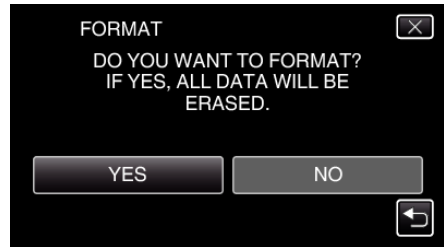

- After formatting, tap "OK".

Copying

Importing Files from the USB External Hard Disk Drive

You can copy video files from a USB external hard disk drive to the built-in memory of this unit or an SD card.

- This operation cannot be completed if the remaining battery power is not enough. Charge the battery fully first.

- 1 Select video mode.
- 2 Tap "IMPORT FROM DEVICE" in "BACK-UP".

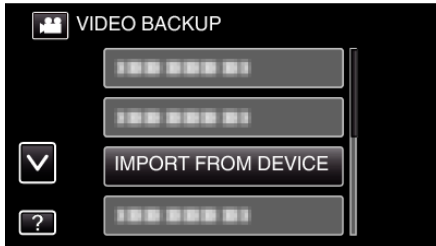

- 3 Tap "USB HDD→BUILT-IN MEM" or "USB HDD→SD".



- Files will be imported to the selected media.

- 4 Tap on the folder to import.

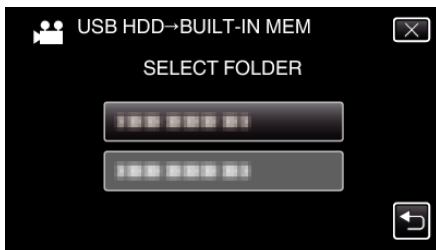

- 5 Tap on the files to import.

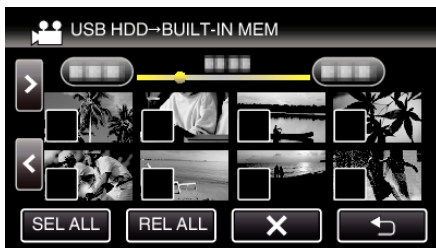

- ✓ appears on the selected files.
To remove ✓ from a file, tap on the file again.
- Tap "SEL ALL" to select all files.
- Tap "REL ALL" to release all selections.

- 6 Tap "SET".

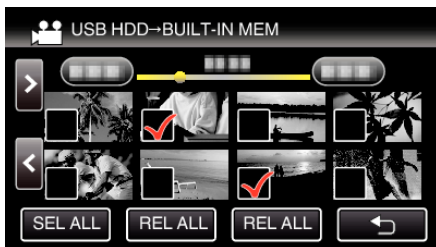

- "SET" is deactivated when no file is selected.

- 7 Tap "YES".

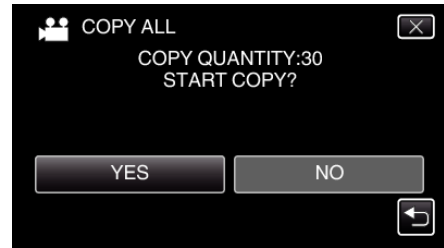

- Importing starts when "YES" is tapped.
- To cancel importing of files, tap "STOP", then tap "YES".

- 8 After importing, tap "OK".

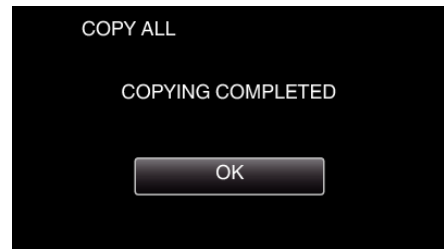

- 9 Close the LCD monitor of this unit to turn off this unit and disconnect the USB cable.

Memo :

- Files that are saved to the USB external hard disk drive from other devices cannot be copied to this unit.

Copying Files to an SD Card

You can copy videos and still images from the built-in memory to SD card. Copying still images to cards makes it convenient to bring them to the shop for printing (developing).

- This operation cannot be completed if the remaining battery power is not enough. Charge the battery fully first.

Caution :

- Make sure that there is enough space left in the destination medium.
- Videos in the SD card cannot be copied to the built-in memory.

- 1 Open the LCD monitor.

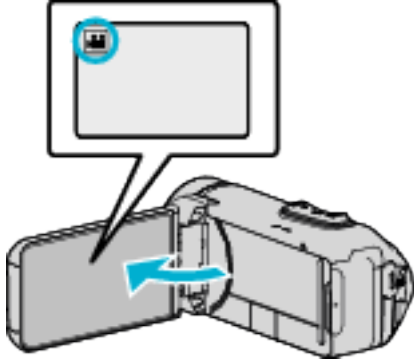

- Tap or to select the video or still image mode.

- 2 Tap **PLAY** to select the playback mode.

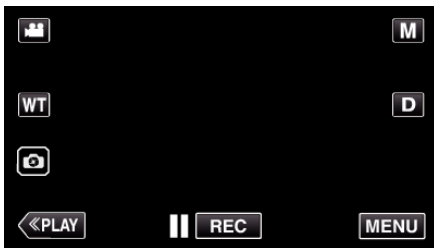

- The mode changes between recording and playback with every tap.

- 3 Tap **MENU**.



- 4 Tap **EDIT**.



- 5 Tap **COPY**.

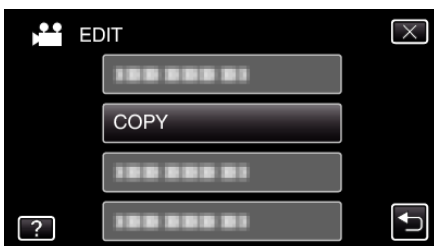

- 6 Tap on the files to copy.



- ✓ appears on the selected files. To remove ✓ from a file, tap on the file again.
- Tap **SEL ALL** to select all files.
- Tap **REL ALL** to release all selections.

- 7 Tap **SET**.



- **SET** is deactivated when no file is selected.

- 8 Tap **YES**.



- Copying starts.
- After copying, tap **OK**.

Copying to Windows PC

You can copy files to a computer using the provided software.

Discs can also be created using the computer's DVD or Blu-ray drive.

If the provided software is not installed, this unit will be recognized as an external storage when connected.

Memo :

- To record to discs, a recordable DVD or Blu-ray drive is required for the computer in use.
- To create DVD-Video discs using the provided software, it is necessary to install the additional software (software for creating DVD-Video). For details, refer to the Pixela homepage.

<http://www.pixela.co.jp/oem/jvc/mediabrowser/e/>

- Backing up of files using other softwares is not supported.

Trouble with Using the Provided Software Everio MediaBrowser 4

Consult the customer service center below.

- Pixela User Support Center

Telephone	USA and Canada (English): +1-800-458-4029 (toll-free) Europe (UK, Germany, France, and Spain) (English):+800-1532-4865 (toll-free) Other Countries in Europe (English):+44-1489-564-764 Asia (Philippines) (English): +63-2-438-0090
Homepage	http://www.pixela.co.jp/oem/jvc/mediabrowser/e/

- For details on how to use the software, refer to "MediaBrowser Help" in the "Help" menu of Everio MediaBrowser 4.

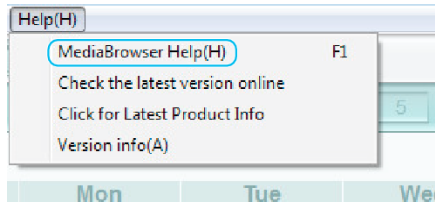

Verifying System Requirements (Guideline)

Windows 8/Windows 8.1

- 1 Display "Apps".
(For Windows 8) Click the "Search" charm.
(For Windows 8.1) Click .

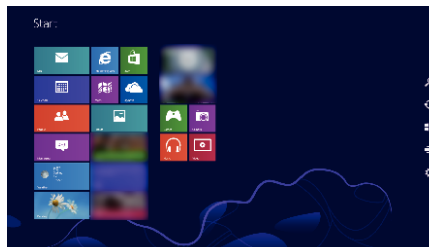

- 2 Right-click "Computer" or "PC" in the "Windows System Tool" menu to select the checkbox.

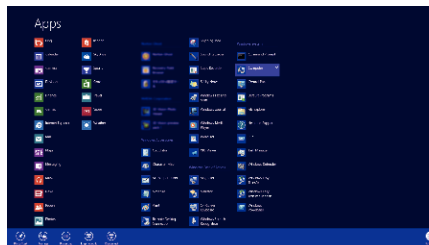

- 3 Click "Properties" on the bottom bar to display.

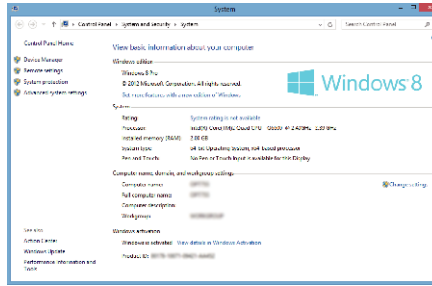

- If a "Computer" icon is shown on desktop, right-click the icon and select "Properties" in the menu to display your computer information.

Windows Vista/Windows 7

- 1 Click the start button.

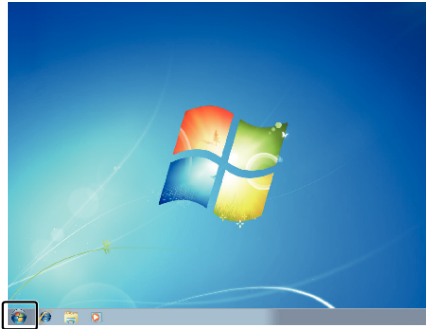

- 2 Right-click Computer.

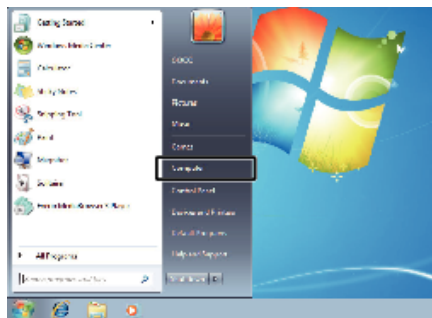

- 3 Click "Properties".

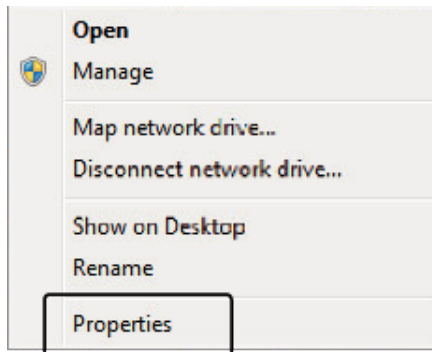

- 4 Check the items with the table below.

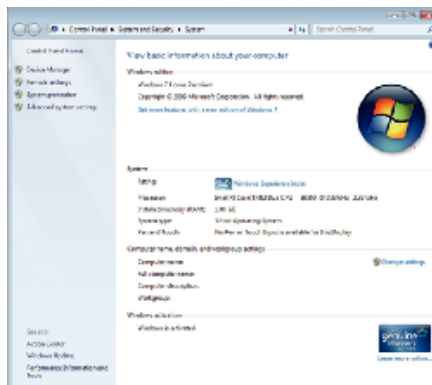

Copying

	Windows 8	Windows Vista/Windows 7
OS	Windows 8 64-bit Windows 8 or Windows 8 Pro (Pre-installed versions, desktop mode only) Windows 8.1 64-bit Windows 8.1 or Windows 8.1 Pro (Pre-installed versions, desktop mode only)	Windows Vista 32/64-bit Home Basic or Home Premium (Pre-installed versions only) Service Pack 2 Windows 7 32/64-bit Home Premium (Pre-installed versions only) Service Pack 1
CPU	Intel Core Duo, CPU 1.66 GHz or higher (Intel Core 2 Duo, CPU 2.13 GHz or higher recommended)	Intel Core Duo, CPU 1.66 GHz or higher (Intel Core 2 Duo, CPU 2.13 GHz or higher recommended)
RAM	At least 2 GB	At least 2 GB
Video editing	Intel Core i7, CPU 2.53 GHz or higher recommended	Intel Core i7, CPU 2.53 GHz or higher recommended

■ Other requirements

Display: 1024×768 pixels or above (1280×1024 pixels or above recommended)

Graphic: Intel G965 or higher recommended

Memo :

- If your PC does not meet the above system requirements, operations of the provided software cannot be guaranteed.
- For more information, contact your PC's manufacturer.

Installing the Provided Software (Built-in)

You can display the recorded images in calendar format and perform editing using the provided software.

- This operation cannot be completed if the remaining battery power is not enough. Charge the battery fully first.

Preparations

Connect this unit to a computer with a USB cable.

■ Windows 8/Windows 8.1

- 1 Open the terminal cover.
- 2 Connect to your PC using the provided USB cable.
 - Before connecting the cable, close the LCD monitor to turn off this unit.

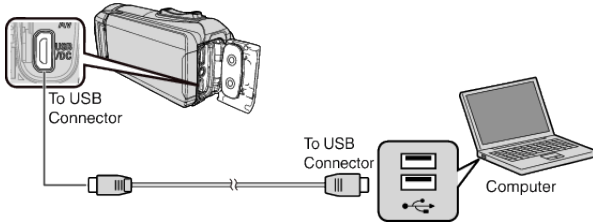

- 3 Open the LCD monitor.

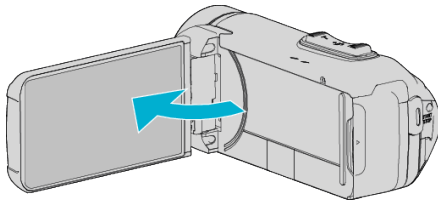

- This unit turns on and the "SELECT DEVICE" menu appears.

- 4 Tap "CONNECT TO PC".



- 5 Tap "PLAYBACK ON PC".

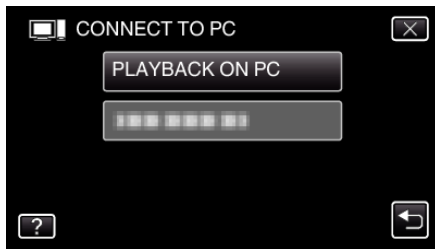

- Disconnect the USB cable to return to the recording or playback screen.
- "Everio Software Setup" appears on the computer. Operations are to be performed on the computer after the screen switches.

- 6 Perform the following operations on your computer.

- 1 Display "Apps".
(For Windows 8) Click the "Search" charm.
(For Windows 8.1) Click ①.

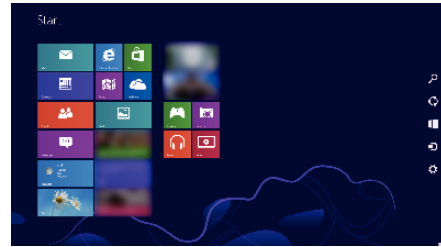

- 2 Click "Computer" or "PC" in the "Windows System Tool" menu.

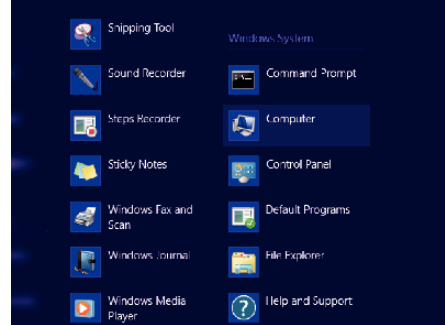

- If a "Computer" icon is shown on desktop, double-click the icon to open "Computer".
- 3 Double-click the "JVCCAM_APP" icon in "Devices with Removable Storage".

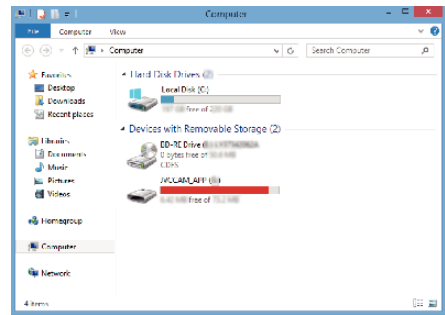

- 4 Double-click "install (or Install.exe)".

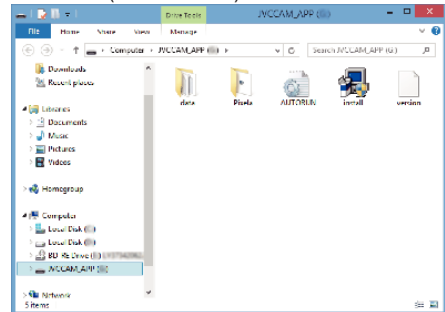

- 5 Click "Yes" on the User Account Control screen.

- "Software Setup" appears after a while.

- 7 Click "Everio MediaBrowser 4".

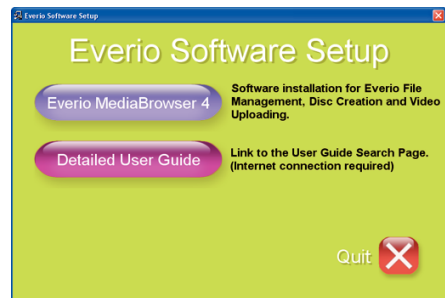

- Follow the on-screen instructions to finish the installation.

- 8 Click "Finish".

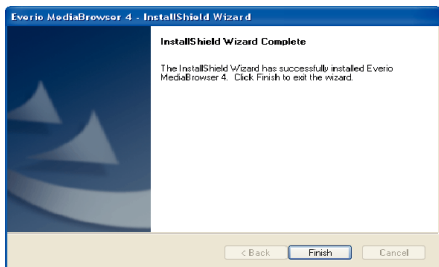

9 Click "Quit".



- Installation is complete, and two icons are created on the desktop.

10 Remove this unit from your PC.

"Disconnecting this Unit from Computer" (☞ p. 98)

Memo :

- If "Everio Software Setup" doesn't appear, double-click "JVCCAM_APP" in "My Computer" or "Computer", then double-click "install (or Install.exe)".
- If the auto play dialog box appears, select "Open folder to view files" and click "OK". Then, click "install (or Install.exe)" in the folder.

■ Windows Vista/Windows 7

1 Open the terminal cover.

2 Connect to your PC using the provided USB cable.

- Before connecting the cable, close the LCD monitor to turn off this unit.

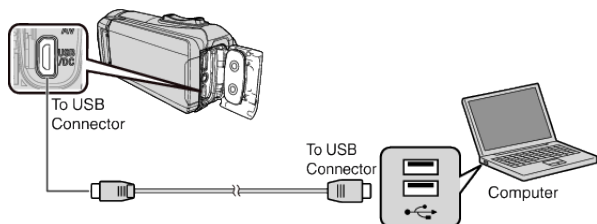

3 Open the LCD monitor.

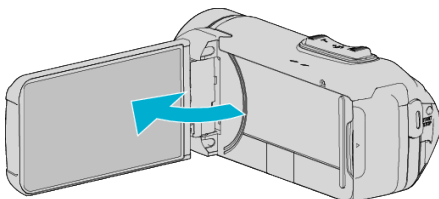

- This unit turns on and the "SELECT DEVICE" menu appears.

4 Tap "CONNECT TO PC".



5 Tap "PLAYBACK ON PC".

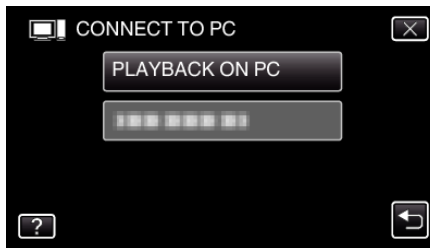

- "Everio Software Setup" appears on the computer. Operations are to be performed on the computer after the screen switches.

6 Perform the following operations on your computer.

- 1 Click "Open folder to view files" on the auto play dialog box, and then double-click "install.exe".
- 2 Click "Yes" on the User Account Control screen.

*Windows 7

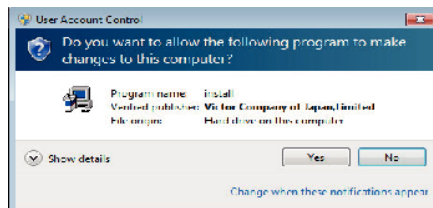

- In case of Windows Vista, click "Allow" (continue).
- "Software Setup" appears after a while.
- If it doesn't appear, double-click "JVCCAM_APP" in "Computer" or "My Computer", then double-click "install.exe".

7 Click "Everio MediaBrowser 4".

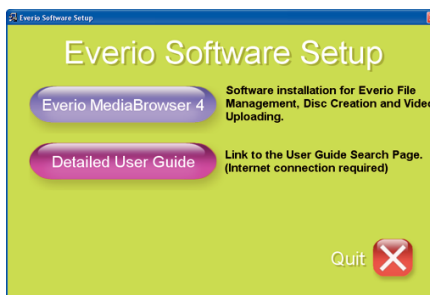

- Follow the on-screen instructions to finish the installation.

8 Click "Finish".

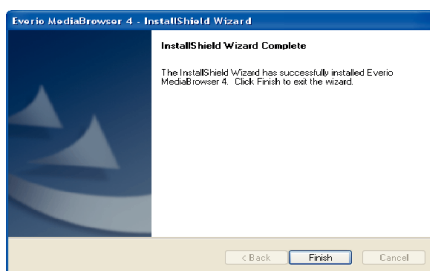

9 Click "Quit".



- Installation is complete, and two icons are created on the desktop.

10 Remove this unit from your PC.

"Disconnecting this Unit from Computer" (☞ p. 98)

Memo :

- If "Everio Software Setup" doesn't appear, double-click "JVCCAM_APP" in "My Computer" or "Computer", then double-click "install (or Install.exe)".
- If the auto play dialog box appears, select "Open folder to view files" and click "OK". Then, click "install (or Install.exe)" in the folder.

Backing Up All Files

Before making backup, make sure that enough free space is left in the computer's hard disk (HDD).

Backup will not start if there is not enough free space.

- This operation cannot be completed if the remaining battery power is not enough. Charge the battery fully first.

- 1 Open the terminal cover.
- 2 Connect to your PC using the provided USB cable.
 - Before connecting the cable, close the LCD monitor to turn off this unit.

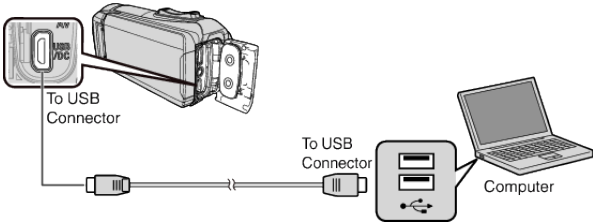

- 3 Open the LCD monitor.

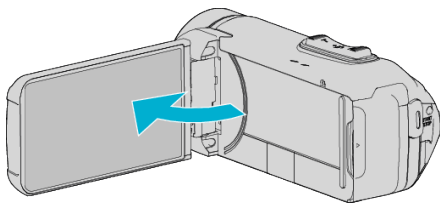

- This unit turns on and the "SELECT DEVICE" menu appears.

- 4 Tap "CONNECT TO PC".



- 5 Tap "BACK UP".

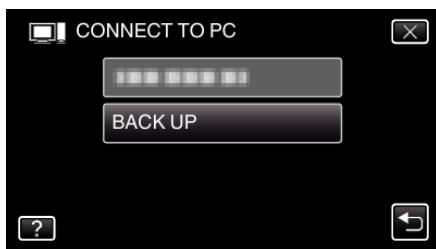

- Disconnect the USB cable to return to the recording or playback screen.
- The provided software Everio MediaBrowser 4 starts up on the computer. The subsequent operations are to be performed on the computer.

- 6 Select the source of the image file.

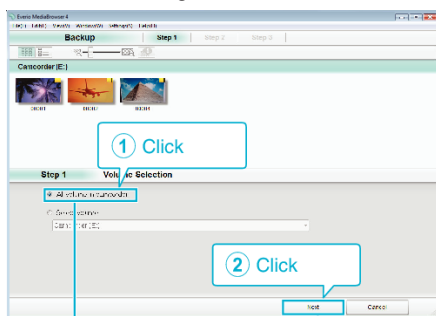

Click "All volume in camcorder"

- 7 Start backup.

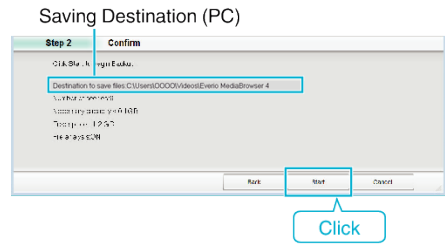

- Backup starts.

- 8 After backup is complete, click "OK".

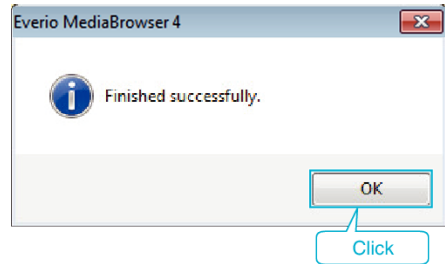

- 9 Remove this unit from your PC.

Memo :

- Before making backup, load the SD card in which the videos and still images are stored on this unit.
- If you encounter any problems with the provided software Everio MediaBrowser 4, please consult the "Pixela User Support Center".

Telephone	USA and Canada (English): +1-800-458-4029 (toll-free) Europe (UK, Germany, France, and Spain) (English):+800-1532-4865 (toll-free) Other Countries in Europe (English):+44-1489-564-764 Asia (Philippines) (English): +63-2-438-0090
Homepage	http://www.pixela.co.jp/oem/jvc/mediabrowser/e/

- Delete unwanted videos before making backup. It takes time to back up many videos.

"Deleting Unwanted Files" (p. 61)

Disconnecting this Unit from Computer

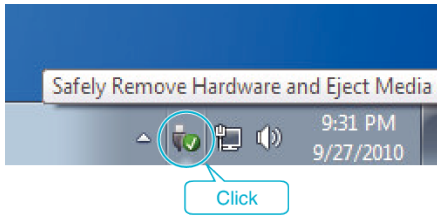

(Windows 7/Windows 8/Windows 8.1)

- 1 Click "Safely Remove Hardware and Eject Media".
 - 2 Click all "JVCCAM~".
 - 3 Disconnect the USB cable and close the LCD monitor.
- (Windows Vista)

- 1 Click "Safely Remove Hardware and Eject Media".
- 2 Click "Safely Remove USB Mass Storage Device".
- 3 Click "OK".
- 4 Disconnect the USB cable and close the LCD monitor.

Organizing Files

After backing up your files, organize them by adding labels such as "Family Trip" or "Athletic Meet". This is useful not only for creating discs, but for viewing the files too.

- 1 Double-click on the Everio MediaBrowser 4 icon.
 - The provided software starts up.



- 2 Display the month of the files to organize.

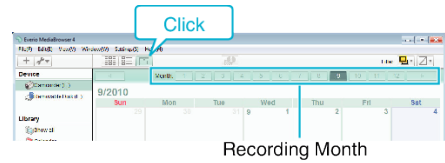

- 3 Create a user list.

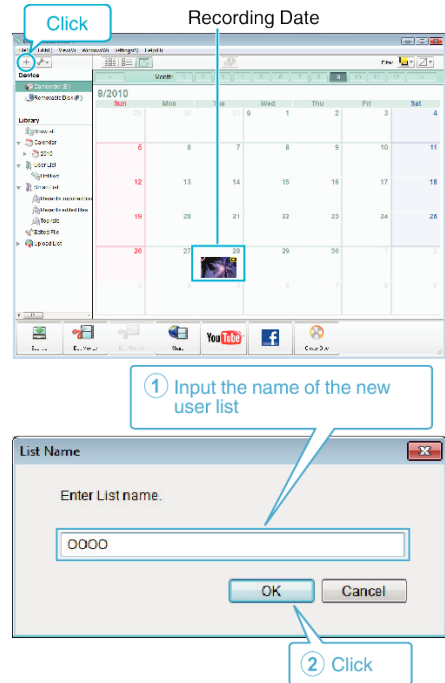

- A new user list is added to the user list library.

- 4 Click on the recording day.
 - The thumbnails of the files recorded on the day are displayed.



- 5 Register files to the created user list.

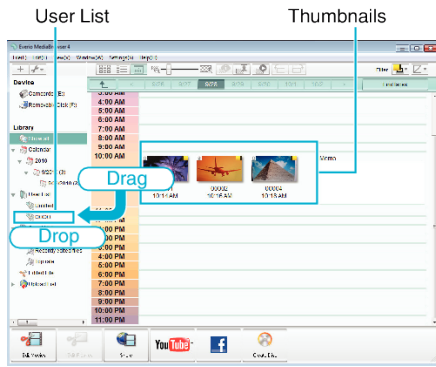

Identifying Video or Still Image :

- You can select files using the “SELECT” menu on the top right of the screen.
- Check the video/still image icon on the top right corner of the thumbnail.



Memo :

- If you encounter any problems with the provided software Everio MediaBrowser 4, please consult the “Pixela User Support Center”.

Telephone	USA and Canada (English): +1-800-458-4029 (toll-free) Europe (UK, Germany, France, and Spain) (English):+800-1532-4865 (toll-free) Other Countries in Europe (English):+44-1489-564-764 Asia (Philippines) (English): +63-2-438-0090
Homepage	http://www.pixela.co.jp/oem/jvc/mediabrowser/e/

Recording Videos to Discs

Copy the files that are arranged using the user list to discs.

- 1 Insert a new disc into the PC’s recordable DVD drive.
- 2 Select the desired user list.

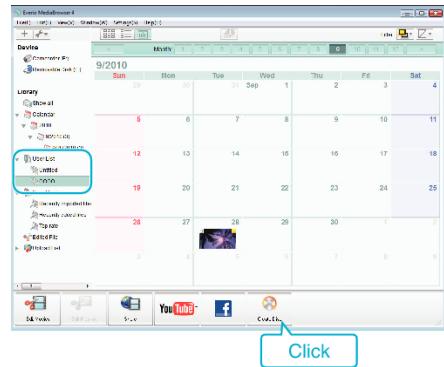

- 3 Select the disc type.

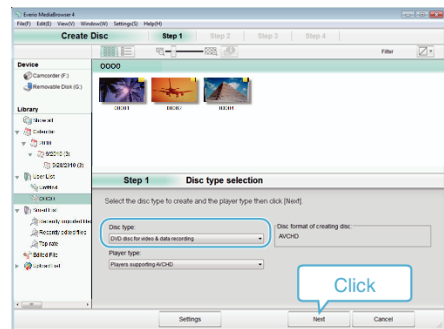

- 4 Select the files to copy to disc in order.

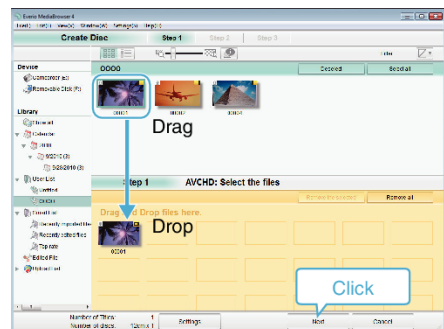

- Click “Settings” to select the disc type.
- Click “Select all” to select all the displayed files.
- After selecting, click “Next”.

- 5 Set the title of the top menu of the disc.

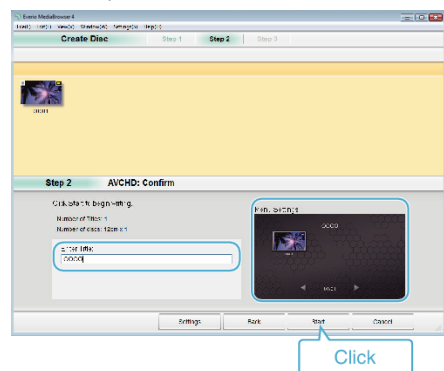

- Click “Settings” to select the menu background.
- After setting, click “Start”.

- 6 After copying is complete, click “OK”.

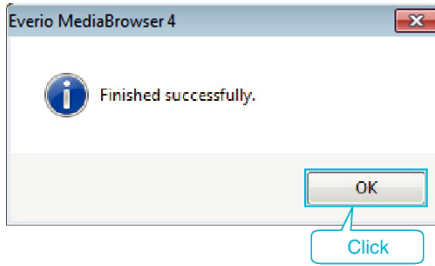

Memo :

- The following types of discs can be used on the provided software Everio MediaBrowser 4.
 - DVD-R
 - DVD-R DL
 - DVD-RW
 - DVD+R
 - DVD+R DL
 - DVD+RW

- The following formats are supported by the provided software Everio MediaBrowser 4.
 - AVCHD
 - DVD-Video*

* To create DVD-Video discs using the provided software, it is necessary to install the additional software (software for creating DVD-Video).

For details, refer to the Pixela homepage.

<http://www.pixela.co.jp/oem/jvc/mediabrowser/e/>

- Use commercially-available software to create a Blu-ray disc.
- Use Everio MediaBrowser 4 Player to play back an AVCHD disc. Refer to the help file of the provided Everio MediaBrowser 4 software to operate.
- When copying videos recorded in UXP or progressive (50p) recording mode to create an AVCHD disc, the videos need to be converted to XP recording mode before copying. Therefore, it may take a longer time than copying videos recorded in other modes.
- To view the help file of Everio MediaBrowser 4, select "Help" from the Everio MediaBrowser 4's menu bar or press F1 on the keyboard.
- If you encounter any problems with the provided software Everio MediaBrowser 4, please consult the "Pixela User Support Center".

Telephone	USA and Canada (English): +1-800-458-4029 (toll-free) Europe (UK, Germany, France, and Spain) (English):+800-1532-4865 (toll-free) Other Countries in Europe (English):+44-1489-564-764 Asia (Philippines) (English): +63-2-438-0090
Homepage	http://www.pixela.co.jp/oem/jvc/mediabrowser/e/

Backing Up Files Without Using Provided Software

Copy the files to a computer using the following method.

- This operation cannot be completed if the remaining battery power is not enough. Charge the battery fully first.

- 1 Open the terminal cover.
- 2 Connect to your PC using the provided USB cable.
 - Before connecting the cable, close the LCD monitor to turn off this unit.

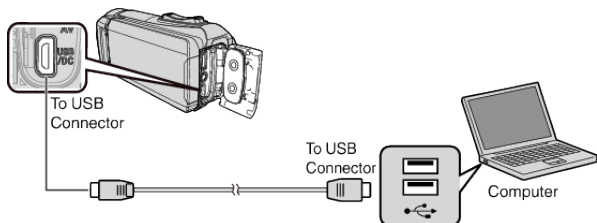

- 3 Open the LCD monitor.

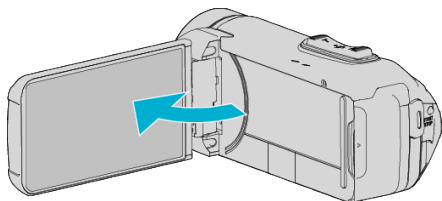

- This unit turns on and the "SELECT DEVICE" menu appears.

- 4 Tap "CONNECT TO PC".



- 5 Tap "PLAYBACK ON PC".

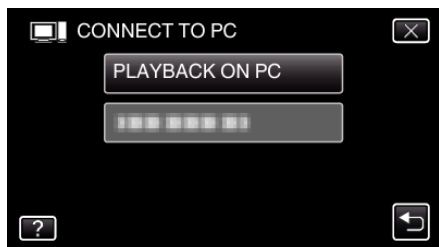

- Disconnect the USB cable to return to the recording or playback screen.
- Close the Everio MediaBrowser 4 program, if it starts.
- The following screen is displayed after the camera operation is completed.



- Operations are to be performed on the computer after the screen switches.

- 6 (Windows 8)
Right-click "Computer" in the "Windows System Tool" menu to select the checkbox, and then click the "JVCCAM_SD" icon. (Windows 7/Windows Vista)
Select "Computer" from the "Start" menu, then click on the "JVCCAM_SD" icon.
 - Open the folder with the desired files.
 - "List of Files and Folders" (p. 102)
- 7 Copy the files to any folder in the computer (desktop, etc).

Caution :

- When the camera and PC are connected by an USB cable, recorded media are read-only.

Memo :

- To edit/view the files, use a software that supports AVCHD (video)/JPEG (still image) files.
- The above operations on computer may vary with the system used.

Disconnecting this Unit from Computer

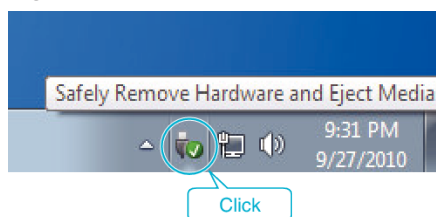

(Windows 7/Windows 8/Windows 8.1)

- 1 Click "Safely Remove Hardware and Eject Media".
 - 2 Click all "JVCCAM~".
 - 3 Disconnect the USB cable and close the LCD monitor.
- (Windows Vista)

- 1 Click "Safely Remove Hardware and Eject Media".
- 2 Click "Safely Remove USB Mass Storage Device".
- 3 Click "OK".
- 4 Disconnect the USB cable and close the LCD monitor.

Copying

List of Files and Folders

Folders and files are created in the built-in memory and SD card as shown below. They are created only when necessary.

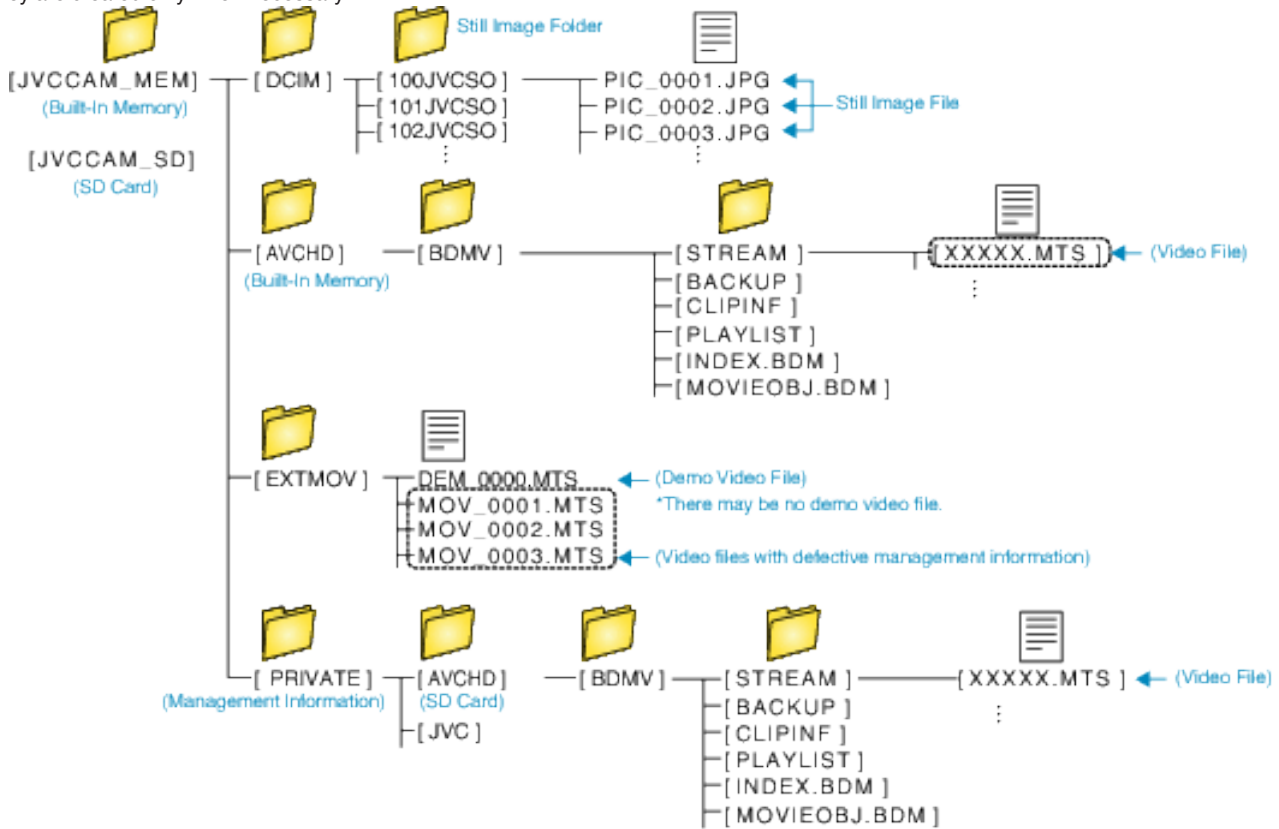

Caution :

- When the camera and PC are connected by a USB cable, recorded media are read-only.

Copying to Mac Computer

Copy the files to a Mac computer using the following method.

Caution :

- This operation cannot be completed if the remaining battery power is not enough. Charge the battery fully first.

- 1 Open the terminal cover.
- 2 Connect to your PC using the provided USB cable.
 - Before connecting the cable, close the LCD monitor to turn off this unit.

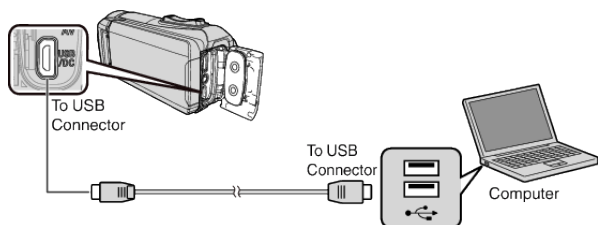

- 3 Open the LCD monitor.

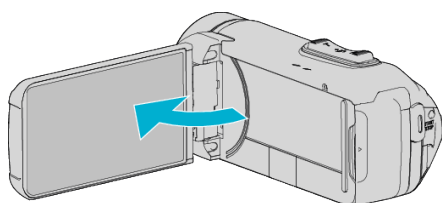

- 4 Tap "CONNECT TO PC".



- 5 Tap "PLAYBACK ON PC".



- Disconnect the USB cable to return to the recording or playback screen.
- The following screen is displayed after the camera operation is completed.

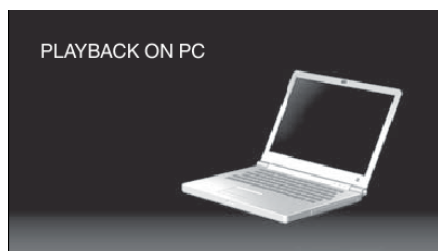

- The "JVCCAM_SD" icon appears on the desktop.

- 6 Load image file to iPhoto.
 - iPhoto launches automatically and videos recorded in the camera are displayed. Load the necessary images.
 - Images on the built-in memory and SD card are displayed separately. Switch between JVCCAM_MEM (built-in memory) and JVCCAM-SD (SD card) displayed under "Devices" in the iPhoto "Source list".
 - Videos loaded using iPhoto cannot be edited using iMovie. To edit videos, load the files from iMovie.
- 7 Edit the video using iMovie.
 - Run iMovie and load the necessary videos to iMovie.
 - Videos loaded using iPhoto cannot be imported to iMovie.
 - For details on operating iMovie, refer to the help file of iMovie.

Caution :

- Do not remove the cable or turn off this unit before image loading is complete.
- When the camera and PC are connected by an USB cable, recorded media are read-only.
- MTS files that are copied to a Mac computer cannot be imported to iMovie. To use MTS files with iMovie, import the files using iMovie.

Memo :

- To edit/view the files, use a software that supports AVCHD (video) files.
- When removing this unit from the computer, drag and drop the "JVCCAM_MEM" or "JVCCAM_SD" icon on the desktop to the trash bin.

iMovie and iPhoto

You can import files from this unit to a computer using Apple's iMovie '8, iMovie '9, iMovie '11, iMovie version 10 (video), or iPhoto (still image). For the PC operating system of iMovie and iPhoto, check the information provided by Apple.

- For the latest information on iMovie or iPhoto, refer to the Apple website.
- For details on how to use iMovie or iPhoto, refer to the help file of the respective softwares.
- There is no guarantee that the operations will work with all computer environments.

Wi-Fi Capabilities

This unit is equipped with Wi-Fi function.

You can do the following using a smartphone via wireless connection.

Name of Function	Capability
DIRECT MONITORING (DIRECT CONNECTION)	<ul style="list-style-type: none"> You can check the image captured on the camera via direct 1-to-1 connection (Wi-Fi Direct) with a smartphone, without the need for an access point (wireless LAN router). Recording of videos and still images may be performed while monitoring. “Image Monitoring via Direct Connection (DIRECT MONITORING)” (p. 106)
INDOOR MONITORING (ACCESS POINT CONNECTION)	<ul style="list-style-type: none"> You can check the image captured on the camera by connecting a smartphone via an access point (wireless LAN router). Recording of videos and still images may be performed while monitoring. “Image Monitoring via an Access Point at Home (INDOOR MONITORING)” (p. 109)
OUTDOOR MONITORING (ACCESS POINT CONNECTION)	<ul style="list-style-type: none"> You can check the image captured on the camera via internet connection with a smartphone while you are outside. Recording of videos and still images may be performed while monitoring. “OUTDOOR MONITORING ” (p. 142)
Record of the location information	<ul style="list-style-type: none"> You can record the location information of the venue where recording is taking place via direct connection (Wi-Fi Direct) with a smartphone supporting the GPS function. The recorded location information can be used on the software provided with this unit. “Recording the Location Information” (p. 112)

Terms Used in this Guide: _____

- In this guide, operations on the touch panel are described as “tap”.
- While the names of the buttons on a smartphone are written as “MENU” or “RETURN”, they may vary according to the smartphone in use.

Refer also to the instruction manual of your smartphone.

Operating Environment

To check the image on the camera from a smartphone, and to transfer videos/still images, it is necessary to meet the following requirements.

Android Smartphone and Tablet Device

① OS: Android2.3 or higher

(This unit is not guaranteed to operate with all models.)

② Supports GPS function (for GPS recording)

③ Able to connect to the internet or Google Play ("Everio sync. 2" required for software installation)

iPhone/iPod touch

① OS: iOS5.1 or higher

(This unit is not guaranteed to operate with all models.)

② Able to connect to the internet or "App Store™" (required for software installation)

Precautions on Using Wi-Fi

Cautions on Wi-Fi Function

- Operation is not guaranteed on all devices.
- This function is not designed for disaster or crime prevention.
- To prevent the situation of forgetting to turn off the power, this unit will turn off automatically after 10 days of continuous usage.
- Leaving the LCD monitor open makes it easier to receive radio waves. Therefore, it is recommended to open the LCD monitor when using the Wi-Fi function.
- Security of Wireless LAN
An advantage of wireless LAN is that instead of using a LAN cable, it transmits information using radio waves, thus enabling LAN connection to be established within the area covered by the radio waves. However, as radio waves penetrate through objects (such as walls) within the range that they cover, security issues, such as interception of transmission or illegal access, may arise if security settings are not configured. Before you connect to the network in a wireless LAN environment, read through the instruction manual for the wireless LAN device in use, and configure the security settings accordingly. Failure to do so may increase the risk of personal information being intercepted, such as user names, passwords, and the content of your mails, or illegal access to the network.
- Due to the design of wireless LAN, note that security may be breached by unusual or unforeseeable means.
- For more details on wireless LAN and network security, please consult the manufacturer of your wireless LAN device.
- JVC shall not be liable for any security issues, troubles, damages or losses arising from the use of this feature.
- Wi-Fi function is not available underwater.

Radio Waves Used by this Product

This product makes use of radio waves in the ISM band (2.4 GHz). Although a radio station license is not required for using this product, please take note of the following.

■ Do not use this product near the following places.

- Industrial, scientific, or medical equipment, such as microwave ovens and pacemakers
- Industrial, scientific, or medical equipment, such as microwave ovens and pacemakers
- Specified low-power radio stations (radio station license not required)
- Bluetooth devices

Equipment such as the above mentioned devices makes use of the same frequency bandwidth as that of Wi-Fi.

Using this product near the above equipment may cause radio wave interference, and result in communication failure or a drop in communication speed. In this case, turn off the power of devices that are not in use.

■ Avoid using this product near a TV or radio set.

TV or radio sets make use of a radio wave frequency bandwidth that is different from that of Wi-Fi, and therefore has no effect on communication by this product or the TV/radio set.

However, when a TV/radio set is placed close to a Wi-Fi product, electromagnetic waves emitted by the Wi-Fi product may cause noise to occur in the sound or images of the TV/radio.

- Communication may not be carried out properly near radio equipment or broadcasting stations. In this case, change the location accordingly.

■ Radio signals are unable to penetrate through reinforced steel, metal, or concrete.

The radio waves used by this product are unable to penetrate through reinforced steel, metal, or concrete materials.

It may difficult for communication to be established if two rooms or floors are separated by these materials.

*Communication may also get weaker when there are human subjects or parts of the body in between the Wi-Fi devices.

■ Do not connect to wireless networks that you do not have authorization for.

Once connected, it may be considered as unauthorized access and legal actions can be taken against you.

■ Do not use the Wi-Fi function outside the country of purchase.

Depending on the country, there may be restrictions on the use of radio waves and any violations could be punishable by law.

Exporting/Bringing the Unit Overseas

Permission from the U.S. government may be required when bringing the unit to an export controlled country set by the U.S. government (such as Cuba, Iraq, North Korea, Iran, Rwanda, and Syria. As of December, 2012). For more information, consult the U.S. Embassy Commercial Service.

Image Monitoring via Direct Connection (DIRECT MONITORING)

You can check the image captured on the camera via direct connection (Wi-Fi Direct) with a smartphone, without the need for an access point (wireless LAN router).

- Recording of videos and still images may be performed while monitoring.

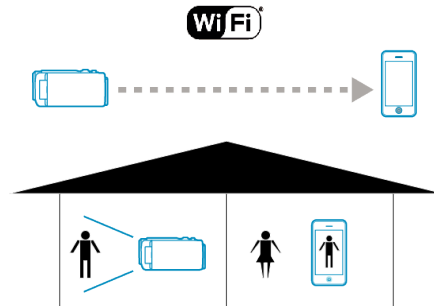

Caution :

- This function is not designed for disaster or crime prevention.
- To prevent the situation of forgetting to turn off the power, this unit will turn off automatically after 10 days of continuous usage.
- When not monitoring from a smartphone, the focus of the camera is fixed.
- Even when monitoring from a smartphone, the focus of the camera will be fixed if not operated for more than 3 hours. (Focus works again when the camera is operated.)
- You may have difficulty establishing a connection via direct monitoring in an environment where the camera is placed away from the smartphone. In this case, connect using the access point (wireless LAN router).

“Image Monitoring via an Access Point at Home (INDOOR MONITORING)”
( p. 109)

- Depending on the device in use or connecting environment, it may take some time to establish a connection.

What You Need

- Smartphone
(Wi-Fi that is compatible with WPA2 is necessary.)

Settings Required in Advance

Set up your camera and smartphone by performing the following operations. For a smartphone with WPS support, refer to the “Wi-Fi Protected Setup (WPS)”.

*WPS is a method to connect the camera and the smartphone wirelessly by easy button operations.

Connecting Smartphone Directly to Camera (Wi-Fi Direct)

Connect the smartphone directly (Wi-Fi Direct) to the camera by either of the following methods.

■ Connection by entering the Wi-Fi password

- 1 Tap "MENU".
(Operation on this camera)
Set the camera to the recording mode.

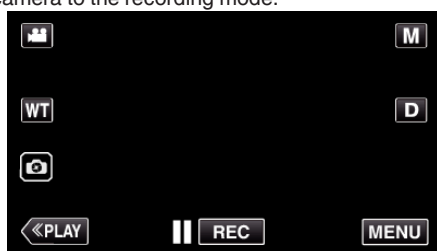

- The top menu appears.

- 2 Tap the "Wi-Fi" (Wi-Fi icon) icon.
(Operation on this camera)

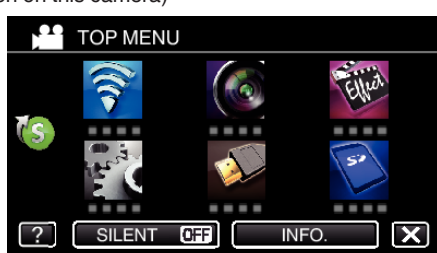

- 3 Tap the "DIRECT CONNECTION" (DIRECT CONNECTION icon) icon in the "Wi-Fi" menu.
(Operation on this camera)



- When "50p" is selected for "SYSTEM SELECT", the following display appears and recording mode is switched to the 50i mode.

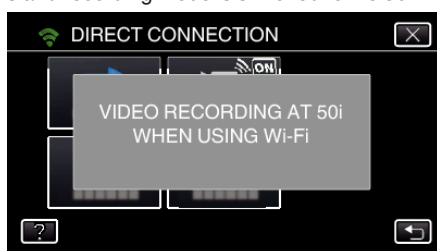

- 4 Check the SSID and the PASS being displayed on the screen of the camera.



- 5 Select the SSID in step 4 from the Wi-Fi network selection screen of your smartphone, and enter the PASS on the password screen.
(Operation on the smartphone)



- For details on connecting your smartphone to a Wi-Fi network, please refer to the instruction manual of the device in use.
- 6 A connection is established and Wi-Fi icon appears on the camera's screen.

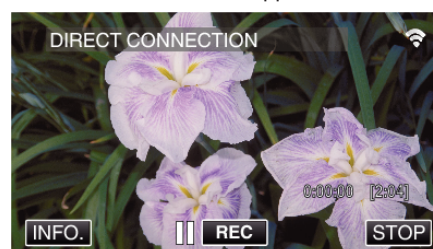

■ Connection by Wi-Fi Protected Setup (WPS)

- 1 Tap "MENU".
(Operation on this camera)
Set the camera to the recording mode.

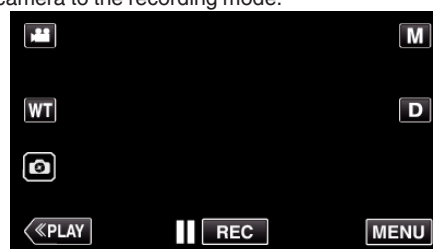

- The top menu appears.

- 2 Tap the "Wi-Fi" (Wi-Fi icon) icon.
(Operation on this camera)

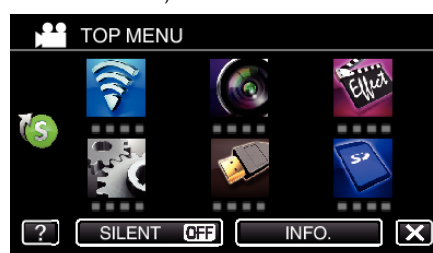

- 3 Tap the "DIRECT CONNECTION" (DIRECT CONNECTION icon) icon in the "Wi-Fi" menu.
(Operation on this camera)



- When "50p" is selected for "SYSTEM SELECT", the following display appears and recording mode is switched to the 50i mode.



- 4 Tap "WPS".
(Operation on this camera)



- 5 Activate WPS on the smartphone within 2 minutes.
(Operation on the smartphone)



- To activate WPS, refer to the instruction manual of the device in use.

- 6 A connection is established and  appears on the camera's screen.



Monitoring Images from Smartphone

Smartphone (Android / iPhone)

Memo :

- Prior to use this function, a smartphone application needs to be installed on the smartphone.

"Installing Smartphone Applications" (p. 119)

- 1 Start "Everio sync. 2" on the smartphone after setting DIRECT CONNECTION.



- 2 Tap "DIRECT MONITORING".



- 3 The recording screen is displayed.



- How to operate from a smartphone
“Using Smartphone Applications” (p. 119)

Image Monitoring via an Access Point at Home (INDOOR MONITORING)

Connect the camera and smartphone wirelessly via access point (wireless LAN router) that has been set up at home. You can monitor the images captured on the camera from the smartphone connected.

- Recording of videos and still images may be performed while monitoring.

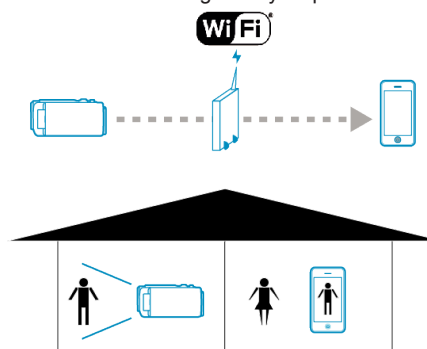

Caution :

- This function is not designed for disaster or crime prevention.
- To prevent the situation of forgetting to turn off the power, this unit will turn off automatically after 10 days of continuous usage.
- When not monitoring from a smartphone, the focus of the camera is fixed.
- Even when monitoring from a smartphone, the focus of the camera will be fixed if not operated for more than 3 hours. (Focus works again when the camera is operated.)

What You Need

- Smartphone
- Access Point (Wireless LAN Router)
Use a product that has a Wi-Fi certification logo.

Memo :

- Depending on the access point (wireless LAN router) in use and signal strength, you may experience connection problems or slow connections.

Operation Method

Connect the camera to the access point (wireless LAN router)



Connect the camera to the access point by either of the following methods.

■ Wi-Fi Protected Setup (WPS) Registration

Follow the operations below if the access point (wireless LAN router) in use supports WPS.

- 1 Tap "MENU".
(Operation on this camera)

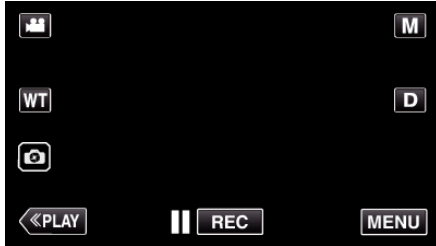

- The top menu appears.

- 2 Tap the "Wi-Fi" (Wi-Fi icon).
(Operation on this camera)



- 3 Tap "Wi-Fi SETTING".
(Operation on this camera)

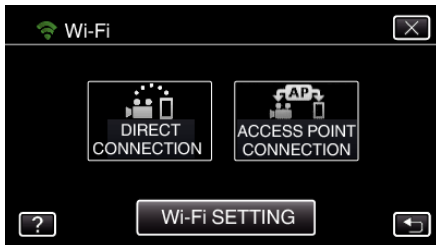

- 4 Tap "ACCESS POINTS".
(Operation on this camera)

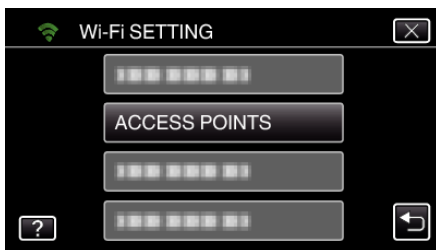

- 5 Tap "ADD".
(Operation on this camera)



- 6 Tap "EZ REGISTRATION WPS".
(Operation on this camera)

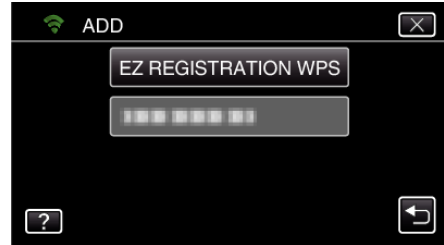

- 7 Activate WPS of the access point (wireless LAN router) within 2 minutes.
 - To activate WPS, refer to the instruction manual of the device in use.

- 8 After registration is complete, tap "OK" on the camera's screen.
(Operation on this camera)



- 9 Select the access point, then tap "SET".



- If several access points are registered, tap on the access point to be used, then tap "USE".
- To delete the access point registered, tap on the access point, then tap "DELETE".

- The following registration methods are also available.
"Registering Access Point Using WPS PIN" (p. 117)
"Registering Access Point Manually" (p. 146)

Connecting Smartphone to Access Point (Wireless LAN Router)



- Connect the smartphone to the access point (wireless LAN router) at home.
- For details on how to connect, refer to the instruction manual of the device in use or the access point (wireless LAN router).
- This setting is not required if the smartphone has already been connected to the access point (wireless LAN router) at home.

Monitoring the images by connecting the smartphone and the camera



- Install “Everio sync. 2” on the smartphone in advance.
“Installing Smartphone Applications” (p. 119)

■ Operation on this camera

- 1 Tap “MENU”.
(Operation on this camera)

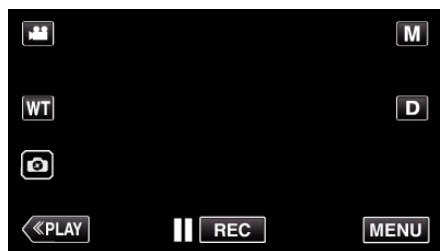

- The top menu appears.

- 2 Tap the “Wi-Fi” (Wi-Fi icon).
(Operation on this camera)

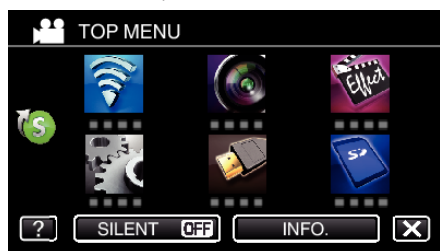

- 3 Tap “ACCESS POINT CONNECTION”.
(Operation on this camera)



- 4 The following is displayed when the camera is connected to the access point.

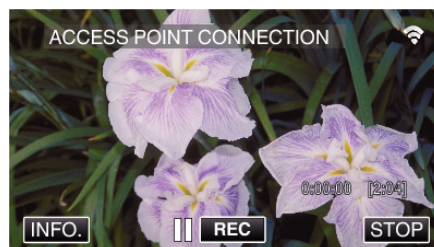

■ Operation on the smartphone

- 1 Start “Everio sync. 2” on the smartphone after setting INDOOR MONITORING.



- 2 Tap “INDOOR MONITORING”.



- 3 Log in with your username and password.
(if authentication cannot be achieved)

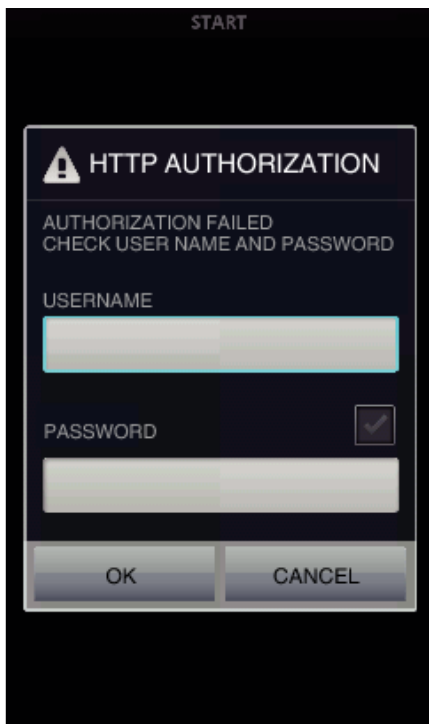

- The username is “everio” and the default password is “0000”.
- To change the password, it is necessary to generate a QR code. “Creating a QR Code” (p. 139)

4 The recording screen is displayed.



- How to operate from a smartphone “Using Smartphone Applications” (p. 119)

Recording the Location Information

You can record the location information of the venue where recording is taking place via direct connection (Wi-Fi Direct) with a smartphone.

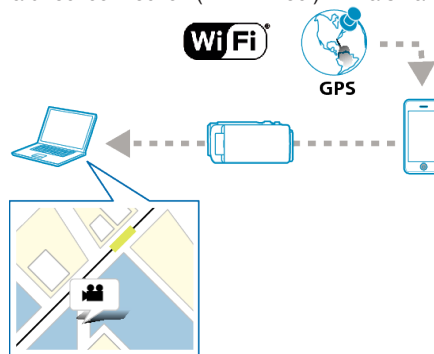

Memo :

- To obtain the location information, it is necessary to connect the smartphone to the camera and start the smartphone application. Also, setting the “LOC INFO TRANS INT” for the smartphone application is necessary. “Smartphone Application Settings” (p. 128)
- Activate the GPS function of the smartphone in advance.
- The recorded location information can be used on the software provided with this unit.

What You Need

- Smartphone

Settings Required in Advance

Set up your camera and smartphone by performing the following operations. For a smartphone with WPS support, refer to the “Wi-Fi Protected Setup (WPS)”.

*WPS is a method to connect the camera and the smartphone wirelessly by easy button operations.

■ Connection by entering the Wi-Fi password

- 1 Tap “MENU”.
(Operation on this camera)
Set the camera to the recording mode.

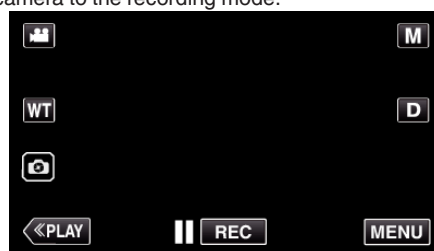

- The top menu appears.

- 2 Tap the “Wi-Fi” (Wi-Fi icon).
(Operation on this camera)

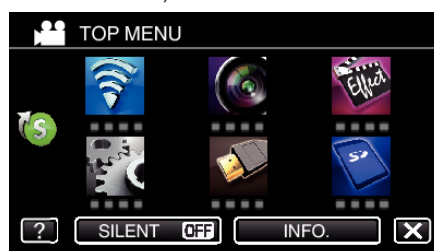

- 3 Tap the “DIRECT CONNECTION” (Wi-Fi Direct icon) icon in the “Wi-Fi” menu.
(Operation on this camera)

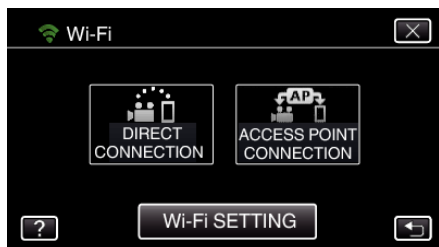

- When “50p” is selected for “SYSTEM SELECT”, the following display appears and recording mode is switched to the 50i mode.



- 4 Check the SSID and the PASS being displayed on the screen of the camera.



- 5 Select the SSID in step 4 from the Wi-Fi network selection screen of your smartphone, and enter the PASS on the password screen. (Operation on the smartphone)



- For details on connecting your smartphone to a Wi-Fi network, please refer to the instruction manual of the device in use.

- 6 A connection is established and appears on the camera's screen.



■ Connection by Wi-Fi Protected Setup (WPS)

- 1 Tap “MENU”. (Operation on this camera)
Set the camera to the recording mode.

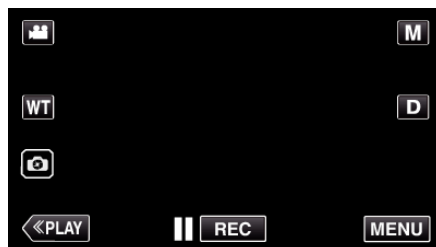

- The top menu appears.

- 2 Tap the “Wi-Fi” () icon. (Operation on this camera)

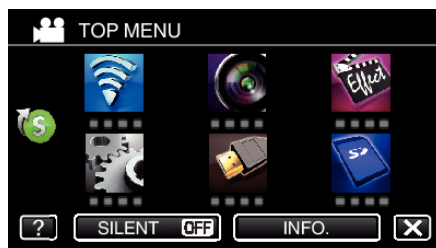

- 3 Tap the “DIRECT CONNECTION” () icon in the “Wi-Fi” menu. (Operation on this camera)



- When “50p” is selected for “SYSTEM SELECT”, the following display appears and recording mode is switched to the 50i mode.



- 4 Tap “WPS”. (Operation on this camera)



- 5 Activate WPS on the smartphone within 2 minutes. (Operation on the smartphone)



- To activate WPS, refer to the instruction manual of the device in use.

- 6 A connection is established and  appears on the camera's screen.



Operation Method

- 1 Activate the GPS function of the smartphone.
(Operation on the smartphone)



- For details on using the smartphone, refer to the instruction manual of the device in use.

- 2 Start "Everio sync. 2" on a smartphone.



- 3 Tap "DIRECT MONITORING".



- 4 Monitor screen is displayed.



- To change the time interval for obtaining the GPS location information (OFF-15 sec.), tap .

"Smartphone Application Settings" (p. 128)

- 5 Receiving the location information
(Display on this camera)



- When the GPS location information is received from the smartphone, an icon  is displayed on the camera screen.

- 6 Start recording.
(Operation on this camera)

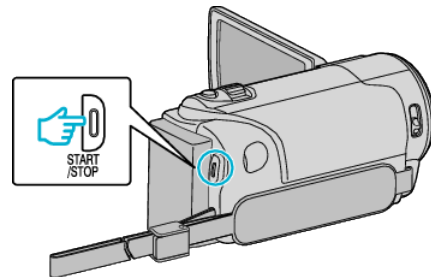

- Press the "START/STOP" button to start a normal recording.

Memo :

- Manual recording cannot be performed.
- It is not possible to switch to the playback mode.

Changing the Settings

To use the Wi-Fi function, it may be necessary to perform some settings on the camera and smartphone.

Menu Settings

Setting	Details
Wi-Fi SETTING	<p>Configures various settings related to the network.</p> <ul style="list-style-type: none"> • SET FROM QR CODE Perform the Wi-Fi setting after the camera reads the QR code generated by following the instruction in Detailed User Guide. “Using Wi-Fi by Creating a QR Code” (☞ p. 135) • ACCESS POINTS Adds or deletes an access point (wireless LAN router). “Registering Access Point Using Wi-Fi Protected Setup (WPS)” (☞ p. 116) “Registering Access Point Using WPS PIN” (☞ p. 117) • MAC ADDRESS (Media Access Control address) Displays the MAC address of the camera. (The above shows the MAC address when connected to an access point, while the below shows the address during direct connection.) “Checking the MAC Address of this Camera” (☞ p. 118) • INITIALIZATION Returns the network settings to their default values. “Initializing the Wi-Fi Settings” (☞ p. 118)

• To register an access point manually, it is necessary to perform the QR code setting.

“Registering Access Point Manually” (☞ p. 146)

Using Wi-Fi

Registering Access Point Using Wi-Fi Protected Setup (WPS)

Follow the operations below if the access point (wireless LAN router) in use supports WPS.

- 1 Tap "MENU".
(Operation on this camera)

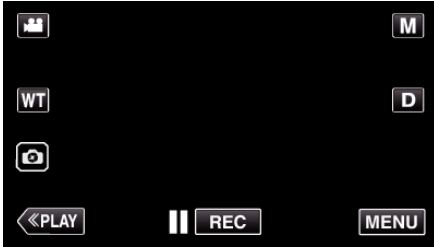

- The top menu appears.

- 2 Tap the "Wi-Fi" (Wi-Fi icon).
(Operation on this camera)



- 3 Tap "Wi-Fi SETTING".
(Operation on this camera)

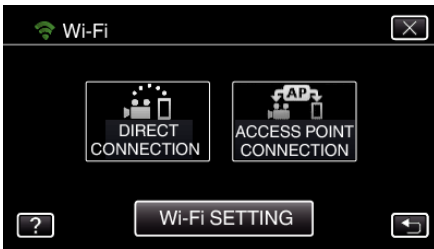

- 4 Tap "ACCESS POINTS".
(Operation on this camera)

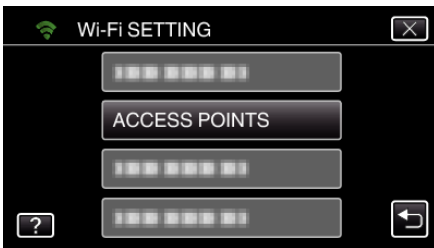

- 5 Tap "ADD".
(Operation on this camera)



- 6 Tap "EZ REGISTRATION WPS".
(Operation on this camera)

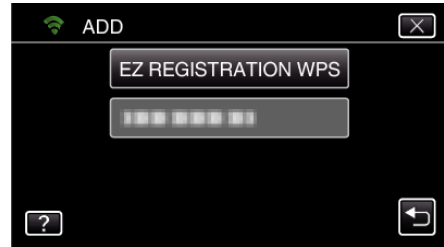

- 7 Activate WPS of the access point (wireless LAN router) within 2 minutes.
 - To activate WPS, refer to the instruction manual of the device in use.
- 8 After registration is complete, tap "OK" on the camera's screen.
(Operation on this camera)



- 9 Select the access point, then tap "SET".



- If several access points are registered, tap on the access point to be used, then tap "USE".
- To delete the access point registered, tap on the access point, then tap "DELETE".

Registering Access Point Using WPS PIN

- 1 Tap "MENU".
(Operation on this camera)

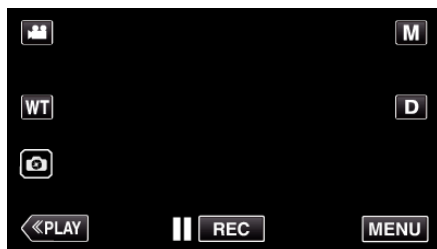

- The top menu appears.

- 2 Tap the "Wi-Fi" (Wi-Fi icon).
(Operation on this camera)

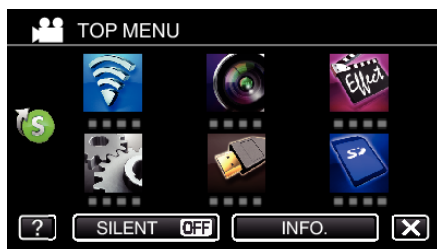

- 3 Tap "Wi-Fi SETTING".
(Operation on this camera)

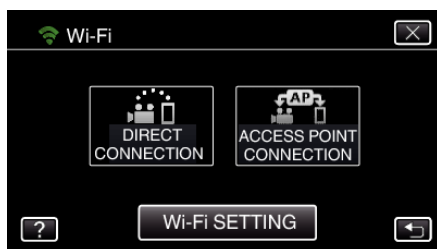

- 4 Tap "ACCESS POINTS".
(Operation on this camera)

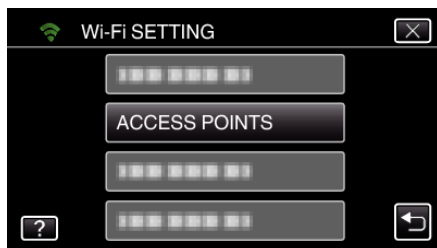

- 5 Tap "ADD".
(Operation on this camera)



- 6 Tap "WPS PIN".
(Operation on this camera)



- The PIN code appears.

- 7 Enter the PIN code displayed on the camera to the access point (wireless LAN router).
 - For details on how to enter the PIN code, refer to the instruction manual of the device in use.
- 8 Tap "START".
(Operation on this camera)



- Tap "START" after entering PIN code to the access point (wireless LAN router).
(Connection cannot be established if "START" is tapped before entering the code.)

- 9 After registration is complete, tap "OK" on the camera's screen.
(Operation on this camera)



- 10 Select the access point, then tap "SET".

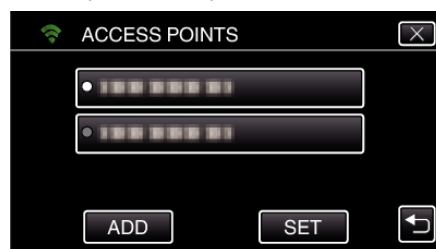

- If several access points are registered, tap on the access point to be used, then tap "USE".
- To delete the access point registered, tap on the access point, then tap "DELETE".

Checking the MAC Address of this Camera

Displays the MAC address of the camera.

- 1 Tap "MENU".
(Operation on this camera)

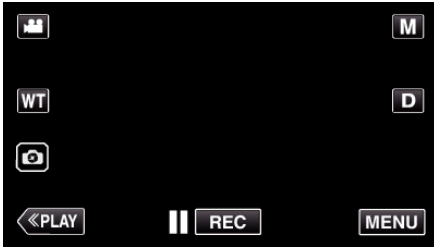

- The top menu appears.

- 2 Tap the "Wi-Fi" (Wi-Fi icon).
(Operation on this camera)

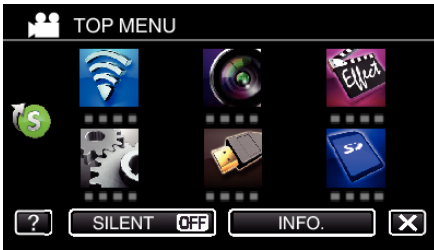

- 3 Tap "Wi-Fi SETTING".
(Operation on this camera)

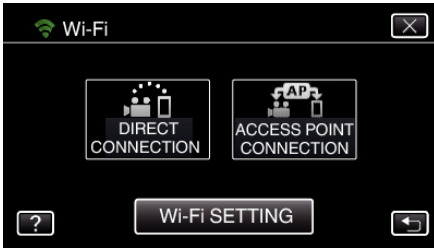

- 4 Tap "MAC ADDRESS".
(Operation on this camera)

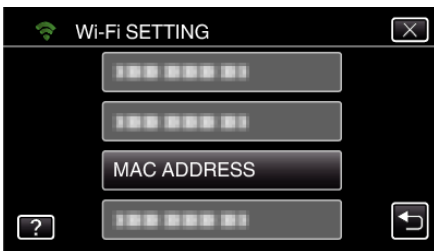

- The MAC address of the camera appears.
(The above shows the address during direct connection, while the below shows the MAC address when connected to an access point.)
- After setting, tap "SET".
- After checking, tap "SET".

Initializing the Wi-Fi Settings

Returns the Wi-Fi settings to their default values.

- 1 Tap "MENU".
(Operation on this camera)

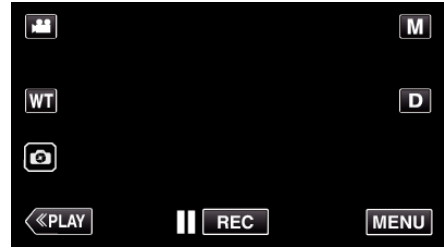

- The top menu appears.

- 2 Tap the "Wi-Fi" (Wi-Fi icon).
(Operation on this camera)

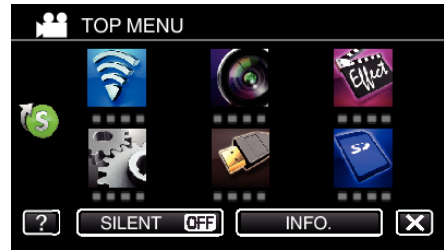

- 3 Tap "Wi-Fi SETTING".
(Operation on this camera)

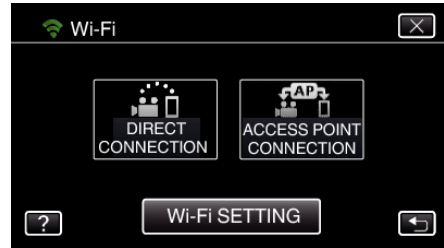

- 4 Tap "INITIALIZATION".
(Operation on this camera)

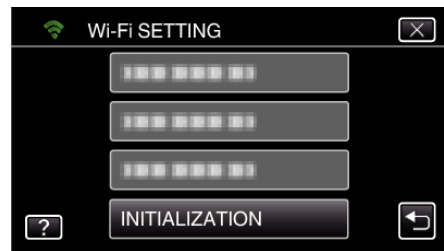

- 5 Tap "YES".
(Operation on this camera)



- To cancel, tap "NO".
- When "YES" is tapped, the network settings return to their default values.

Using Smartphone Applications

- By installing the “Everio sync. 2” smartphone software, images on the camera can be checked from a distance, and recording videos/still images and zooming operation can be performed.
- You can also send images recorded by the camera to the smartphone via Wi-Fi, to enjoy the recorded images on your smartphone or tablet.

Installing Smartphone Applications



■ Android Smartphone

- 1 Tap “PLAY STORE” on the application list.
- 2 Search for the “Everio sync. 2” application.
- 3 Tap on the “Everio sync. 2” application.
 - The detailed information of the application is displayed.
- 4 Tap “INSTALL”.
 - For applications that access data or functions of this unit, a screen that shows the data or functions that will be used is displayed.
- 5 Confirm the content and tap “DOWNLOAD”.
 - Downloading starts.

Deleting the Application

- 1 Tap “PLAY STORE” on the application list.
 - 2 Press the menu button and tap “My apps”.
- A list of previously downloaded applications is displayed.
- 3 Tap on the “Everio sync. 2” application.
 - 4 Tap “Uninstall”, then tap “OK”.

Memo :

The specifications of Google Play are subject to changes without prior notice.

For operating details, refer to the help file of Google Play.

■ iPhone/iPod touch

- 1 Tap “App Store” on the home screen.
- 2 Search for the “Everio sync. 2” application.
 - Search for the iPhone application.
- 3 Tap on the “Everio sync. 2” application.
 - The detailed information of the application is displayed.
- 4 Tap “FREE”→“INSTALL”.
 - Enter your password on the password entry screen.
 - Downloading starts.
 - The downloaded application will be added to the home screen automatically.

Deleting the Application

- 1 Press and hold the “Everio sync. 2” application on the home screen.
- 2 Tap X to confirm the deletion.

Memo :

The specifications of App Store™ are subject to changes without prior notice.

For operating details, refer to the help file of App Store™.

Operating the Smartphone Applications

- Indications on the screen
- “Indications on the screen” (p. 119)

- Transferring videos
- “Transferring Videos (AVCHD format)” (p. 123)
- Transferring still images
- “Transferring Still Images” (p. 126)
- Changing the settings
- “Smartphone Application Settings” (p. 128)

Indications on the screen

■ Initial Screen

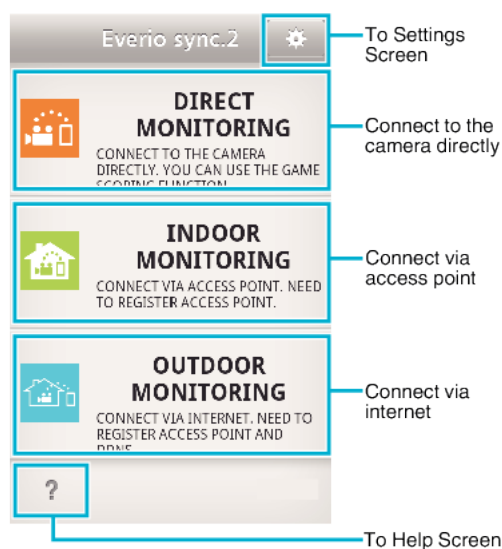

■ Recording Screen

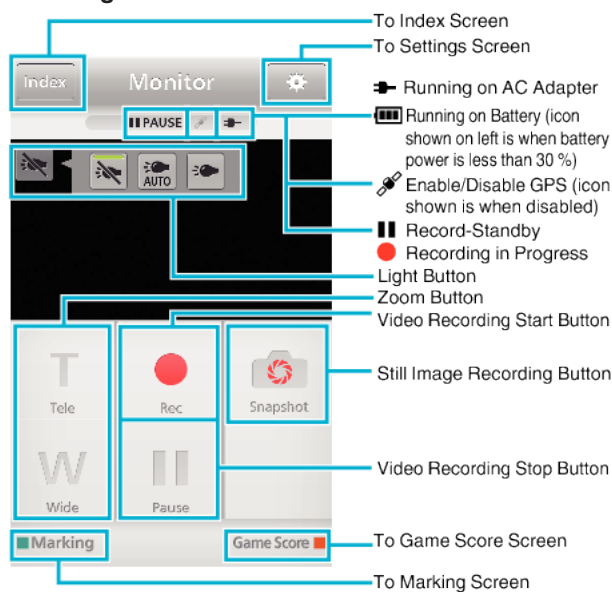

■ Index Screen (AVCHD Video/Still image)

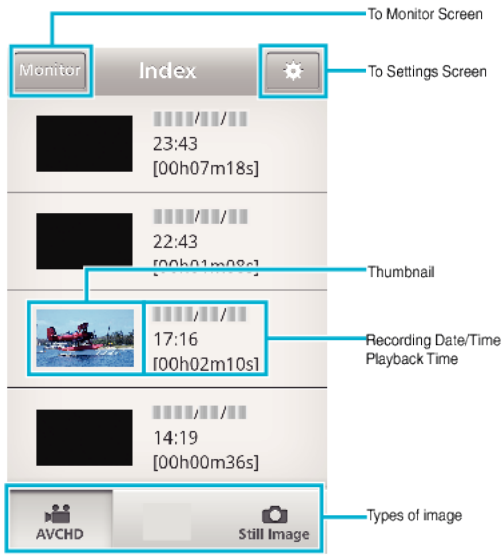

■ Transfer Screen

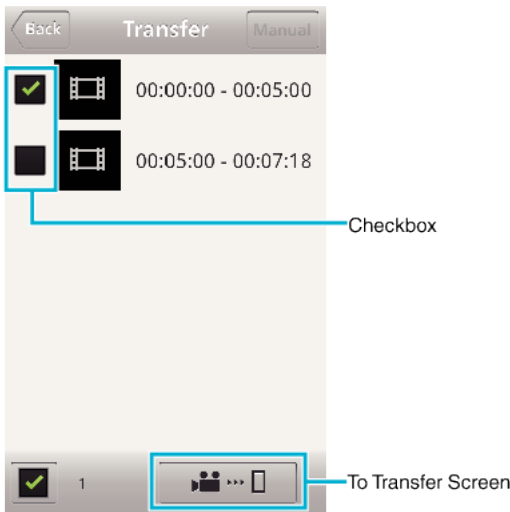

■ Game Score Screen



Caution :

- “Everio sync. 2” for iPhone cannot be used when the iPhone is connected to the mobile phone network. To make use of this feature, connect to the camera or an access point via Wi-Fi.

Using the Markings

Enter the mark to make it easy to find the scene later.

■ Common for Android and iOS

1 Tap “Marking” while recording the video.

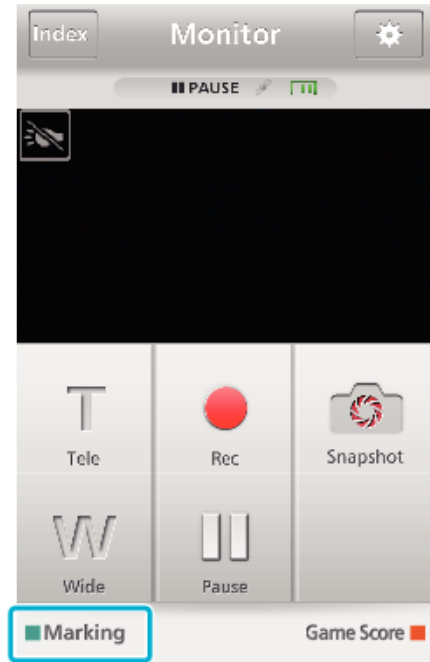

2 Tap the mark icon (🚩) at the scene you want to mark.



- Once a scene is marked, the next mark won't be made within 5 seconds.
- Tap “Monitor” to return to the monitor screen.

■ Screen display of the camera while marking

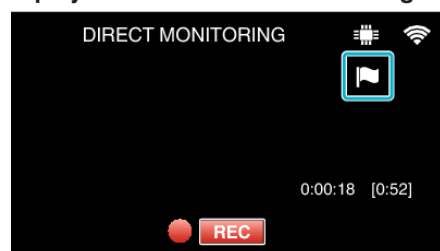

- The mark icon is displayed when a scene is marked.

Using the Game Score

The scores of various sport games can be recorded with video images. Also, the recorded position can be marked to make it easy to find the scenes you want to view later.

Common for Android and iOS

- 1 Tap "Game Score".

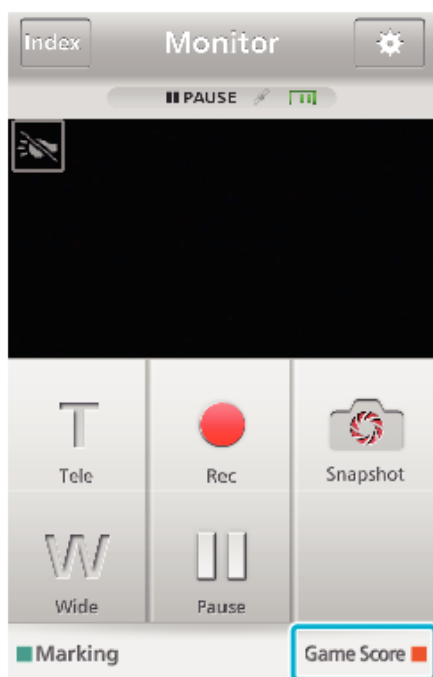

- 2 Tap the scorecard.

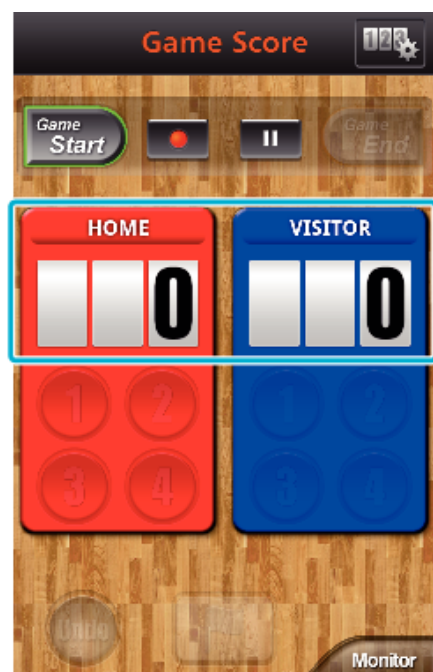

- Proceed to step 5 to keep the team settings unchanged.

- 3 Tap "TEAM SELECTION".

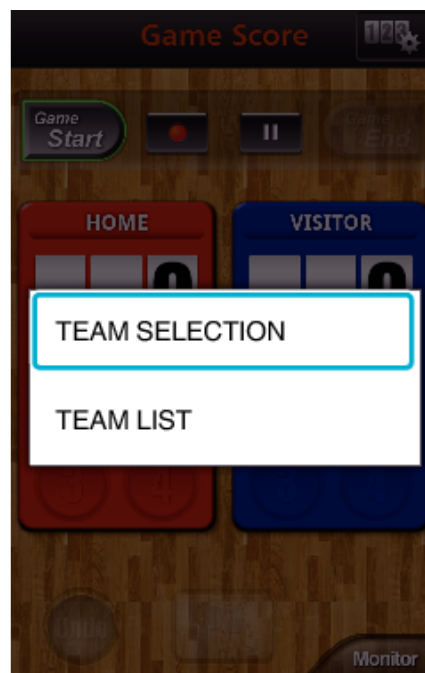

- Tap "TEAM LIST" to change the team name and color, and to add a team.

- 4 Select the team, then tap "OK".

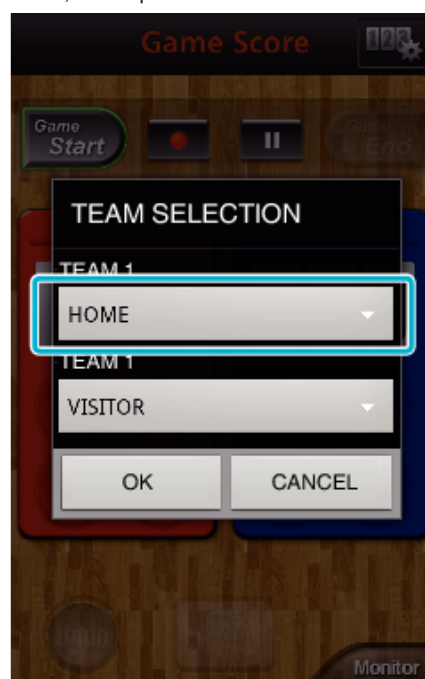

- 5 Tap ● to start recording the video.



6 When the game is started, tap "Game Start".



7 Tap the number when the score is added.



- Tap the number button of the scored team.
- To modify the score, tap the scorecard.
- Tap the "Undo" button to cancel the latest score entry.
- When the score is registered, next entry cannot be made for 5 seconds.

8 Mark the favorite scenes.



- Mark the favorite scenes by tapping the flag icon (🚩)
- Once a scene is marked, the next mark won't be made within 5 seconds.

9 When the game is ended, tap "Game End".



- Tap “OK” if “DO YOU WANT TO EXIT?” appears.
- After the end of the game, video recording is carried on until recording is stopped.
- Tap “Monitor” to return to the monitor screen in Step 1.

Memo :

- Team name and color, the background of the screen can be set prior to recording.
- Select the score button depending on the type of the games.
- The next score won't be registered within 5 seconds after the marking operation. But the score can be registered right after the marking operation by changing the game score setting.

“Game Score Settings” (p. 129)

Screen display of the camera while recording the game score



- 1 Team name and score
Team name can be set prior to recording. (use alphabets and numbers)
“Game Score Settings” (p. 129)

- 2 Game score recording icon

Transferring Videos (AVCHD format)

Transfer videos recorded in AVCHD format to the smartphone.

Caution :

- Video recorded with “SYSTEM SELECT” set to “50p” cannot be transferred.
- The video to be forwarded is converted to the following format.

Item	Details	
System	MP4	
Video	Codec	H. 264/MPEG-4 AVC Baseline Profile
	Resolution * Bit rate is indicated in ()	640X360 (1Mbps)
	Frame rate	25p
Audio	Coding system	AAC
	Sampling rate	48kHz
	Bit	16 bit
	Number of channels	2 ch

- 1 Start “Everio sync. 2” on a smartphone.



- Start the application after confirming that the smartphone is connected to this camera.

- 2 Select the connection type to the camera.



- Tap the current connection type.
- Recording screen appears.

- 3 Tap “Index”.

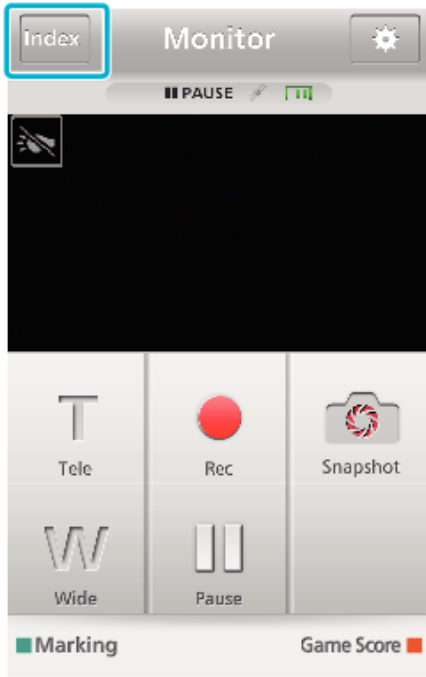

4 In the index screen, tap the desired images to transfer.



- Confirm that the “AVCHD” tab is indicated in the lower part of the screen.

5 Files are displayed as a split files by certain lengths of time. Enter the check mark (1) to the files to transfer, and tap the transfer mark icon (2) on the lower right.

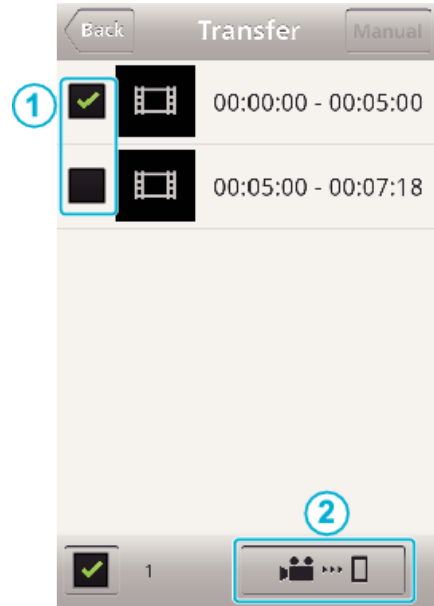

- Number of the selected image files is indicated next to the check mark in lower left.
- To set the length of video you are transferring, refer to the below instructions.
“Smartphone Application Settings” (p. 128)

6 Tap “TRANSFER”.

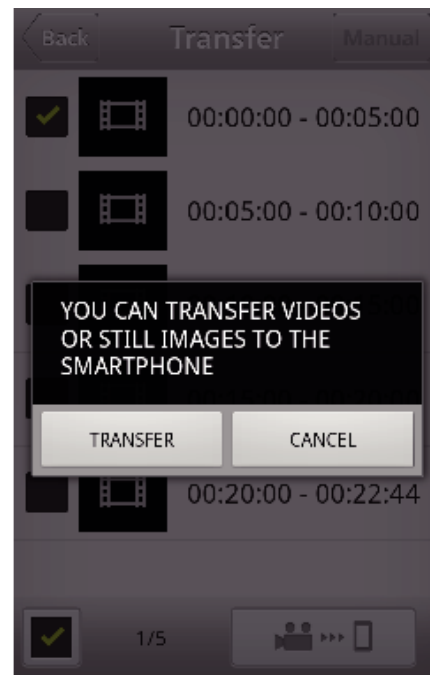

- Tap “CANCEL” to cancel the operation.

7 “TRANSFER” starts.

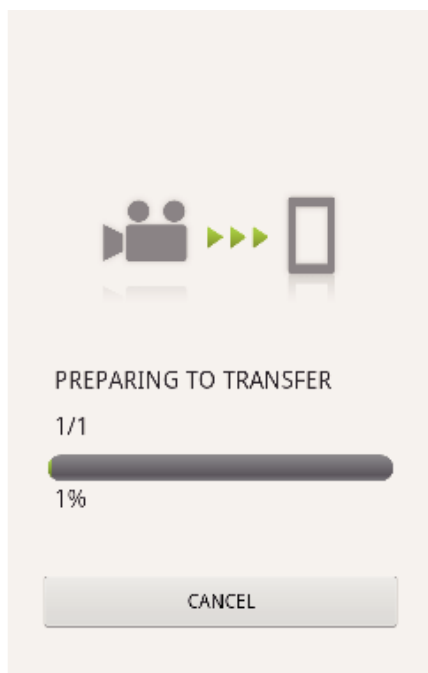

- Tap "CANCEL" to cancel the operation.

8 After transferring is complete, tap "OK".

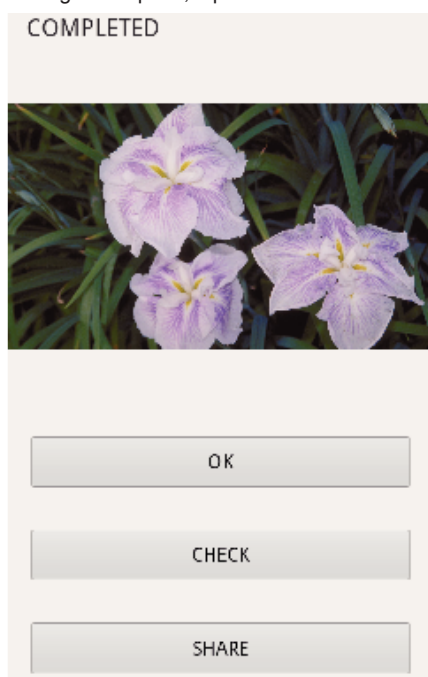

- To play back and check the video, tap "CHECK". (Android only)
- To upload the video, tap "SHARE". (Android only)
Tap the desired service, then proceed to the uploading process.
To make use of a service, it is necessary to perform registration beforehand.

■ Transferring manually

You can set the length of transferred video.

- 1 Tap "MANUAL" in step 5.
- 2 At the start point, enter the starting time of the video.
Specify the lengths of the video by using the slider bar. (10 to 300 sec)
- 3 After confirming the setting, tap "TRANSFER", and then tap "TRANSFER" one more time.

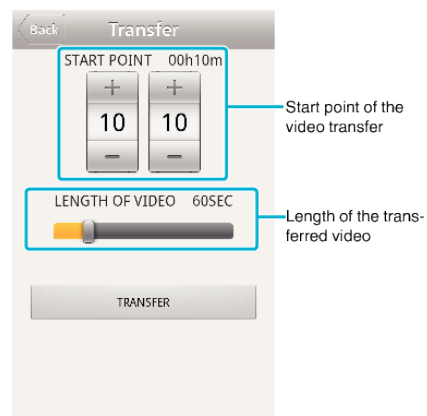

- Tap "+" "-" to set the start point of the video transfer (minutes/seconds).
- Length of the transferred video can be adjusted by using the slider bar.
- The longer the length of the transferred video is set, the longer it takes to transfer the video.

Transferring Still Images

You can transfer recorded still images to your smartphone.
 If the aspect ratio of the original still image is 4:3, the image is reduced by 1600X1200 when transferred.
 If the aspect ratio of the original still image is 16:9, the image is reduced by 1920X1080 when transferred.

1 Start "Everio sync. 2" on a smartphone.



- Start the application after confirming that the smartphone is connected to this camera.

2 Select the connection type to the camera.



- Tap the current connection type.
- Recording screen appears.

3 Tap "Index".

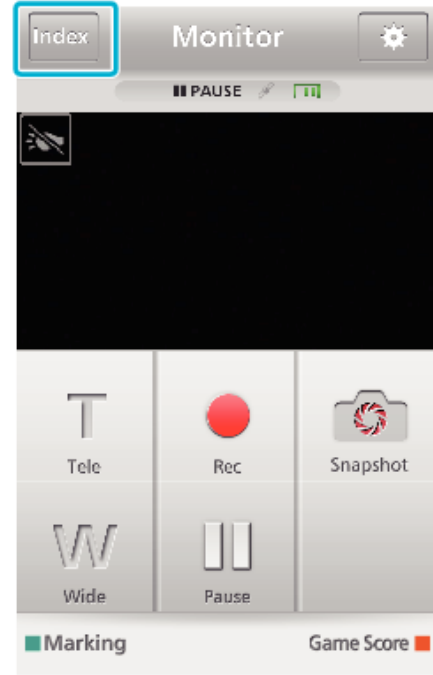



4 Select the "Still Image" tab in the lower part of the screen, and tap the index screen.

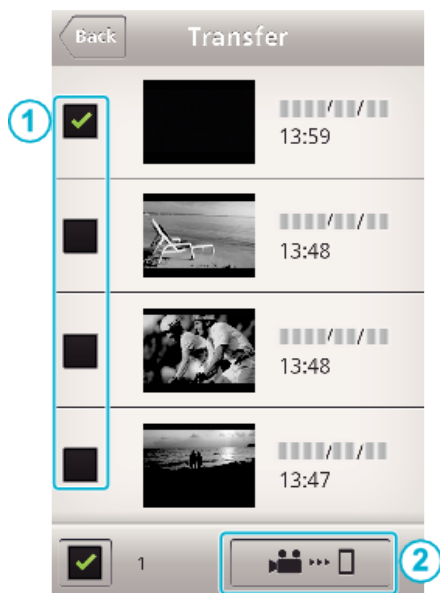

- Tap "Monitor" to return to the monitor screen.
- Tap ⚙️ to move to the setting screen.

5 Enter the check in the checkbox (①) to the still images to transfer, and tap the transfer mark icon (②) on the lower right.



- Tap "Monitor" to return to the monitor screen.
- Tap  to move to the setting screen.

6 Tap "TRANSFER".

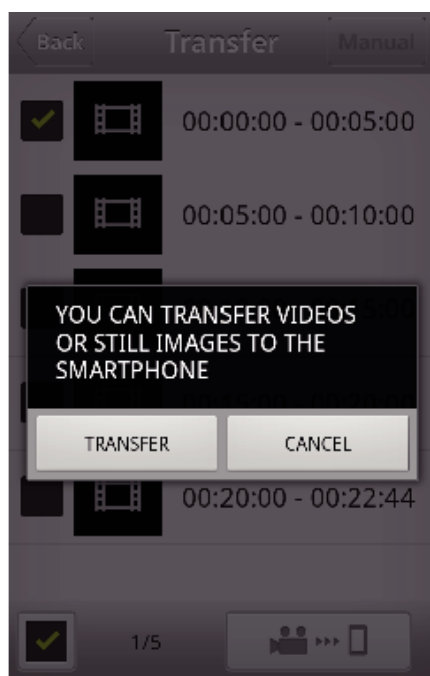

- Tap "CANCEL" to cancel the operation.

7 "TRANSFER" starts.

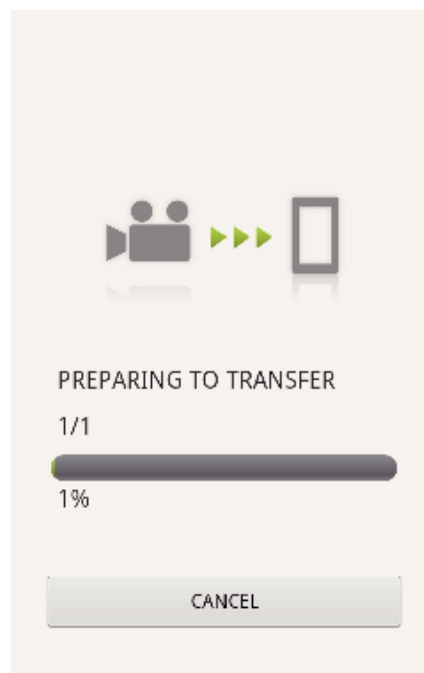

- Tap "CANCEL" to cancel the operation.

8 After transferring is complete, tap "OK".

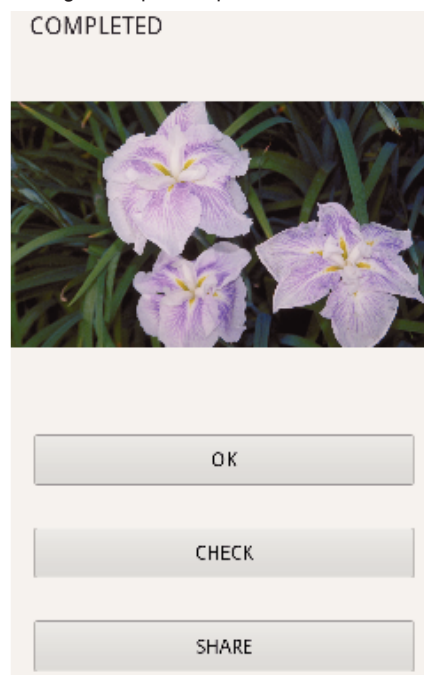

- To play back and check the still image, tap "CHECK". (Android only)
- To upload the still image, tap "SHARE". (Android only)
Tap the desired service, then proceed to the uploading process.
To make use of a service, it is necessary to perform registration beforehand.

Smartphone Application Settings

You can change the settings of the smartphone applications.

■ **Common for Android and iOS**

1 Tap .

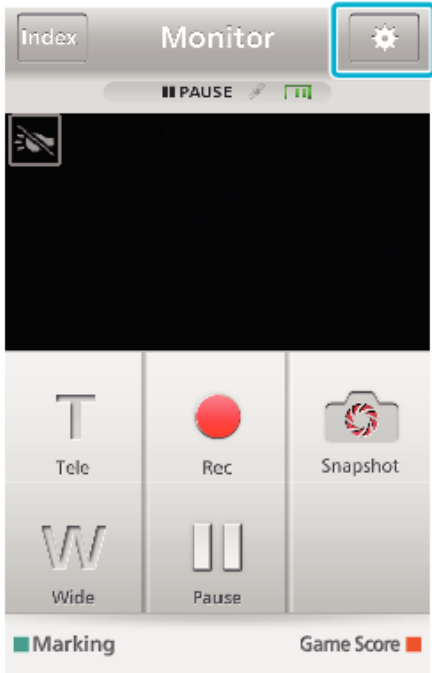

2 Tap the desired setting.

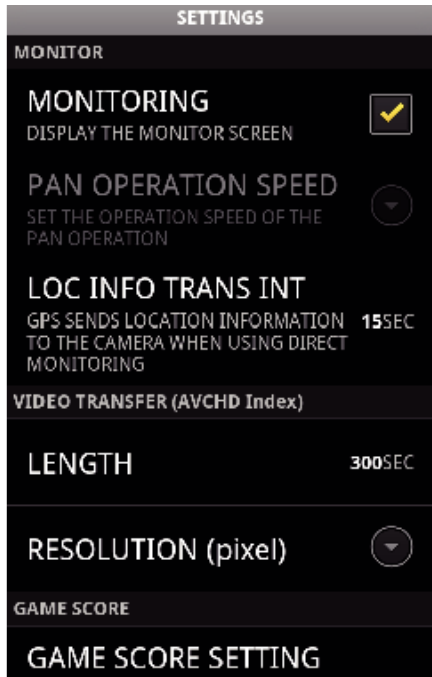

Item	Details
MONITORING	Turns on/off the monitoring function of the screen. (Enter a check mark to set to "ON")
PAN OPERATION SPEED	Not usable on this unit.
LOC INFO TRANS INT	Select the time interval for obtaining the GPS location information while the direct monitoring is in use. (Off - 15 SEC)
VID LENGTH TO TRANS LENGTH	Set the length of video being transferred to the smartphone. (10 - 300SEC) Available for videos in AVCHD format only.
VID SIZE TO TRANS	Cannot be set on this unit. "640x360" will be set.
GAME SCORE SETTING	Enter the recording methods of the game score, as well as the team information. "Game Score Settings" (☞ p. 129)
URL	Enter the URL of the camera that is connected to the smartphone via wireless network.
HTTP AUTHORIZATION	Set the user name and the password for INDOOR MONITORING/OUTDOOR MONITORING. The default username is "everio" (fixed) and the password is "0000". To change the password, it is necessary to generate a QR code. "Creating a QR Code" (☞ p. 139) "Creating a QR Code" (☞ p. 142)
CHANGE BACKGROUND COLOR	Select the background.
NOT TO SLEEP MODE	Set to prevent the smartphone from entering into the sleep mode while the application is in use. (Enter a check mark to disactivate the sleep mode.)
HELP	Displays the help file.
LICENSE AGREEMENT	Displays the license agreement of the software. (Android only)

Memo :

- When connecting to INDOOR MONITORING/OUTDOOR MONITORING, you will be prompted to enter the URL or HTTP authorization if they are not entered or entered incorrectly.

Game Score Settings

Enter the recording methods of the game score, as well as the team information.

Common for Android and iOS

1 Tap .

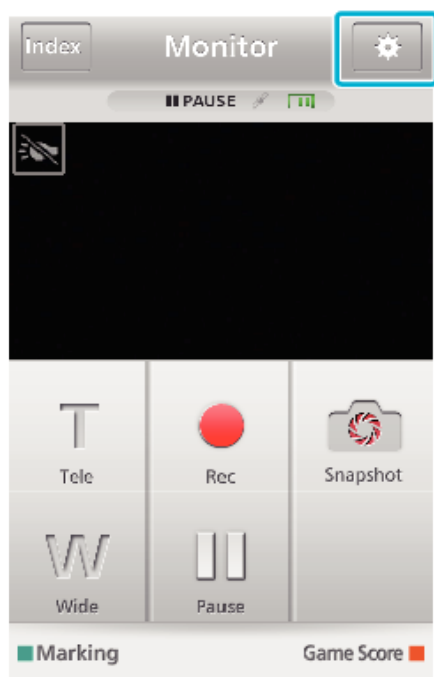





2 Tap "GAME SCORE SETTING".

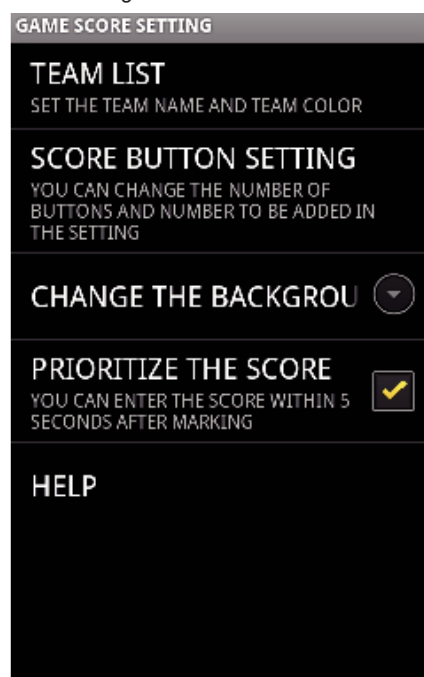

3 Tap the desired setting.



Item	Details
TEAM LIST	<p>Set the team name and the color. To display "HOME" and "VISITOR", tap ① "TEAM LIST". ② "TEAM NAME" and "TEAM COLOR" can be set by tapping each button. ③ Select "TEAM NAME" to display the screen for entering the team name. Tap the column to enter the team name, and press "OK". ④ Select "TEAM COLOR" by tapping the desired color from the color palette. Tap the + button to add a new team.</p>
SCORE BUTTON SETTING	<p>Tap "BUTTON SETTING" to select up to 4 buttons. Each number indicates the score that can be added once. Select the button(s) depending on the type of the games.</p> <div style="display: flex; justify-content: space-around; align-items: center;"> <div style="text-align: center;">  (1 button) </div> <div style="text-align: center;">  (2 button) </div> <div style="text-align: center;">  (3 button) </div> <div style="text-align: center;">  (4 button) </div> </div>
CHANGE BACKGROUND COLOR	Set the background color of the game score screen.
PRIORITIZE THE SCORE	The score can be entered within 5 seconds after the mark operation by selecting the checkbox. However, the marked position is changed when the score is registered.
HELP	Displays the help file.

Memo :

- When registering the team name, the "＼" mark being entered by the smartphone is displayed as "＼" (backslash) on this camera.
- When the team name and player name are registered, the "＼" mark entered by the smartphone is displayed as "＼" (backslash) on this camera.

Troubleshooting

Direct Monitoring

Trouble	Action
Unable to connect to camera. (URL required)	<ul style="list-style-type: none"> • Check whether the Wi-Fi connection is established successfully. • Check whether Wi-Fi is connected to "DIRECT-**EVERIO". • Check whether the smartphone is connected to the camera. • Try again after powering off and on the camera and the terminal (smartphone). • If the smartphone supports Wi-Fi Direct, try generating the QR code and set "ENFORCED GROUP OWNER" to "OFF". This is the "Connection by Wi-Fi Protected Setup (WPS)" method.
Video or audio is interrupted or delayed	<ul style="list-style-type: none"> • If the network speed is slow, videos and audio sound may be interrupted, or delay may become significant. • Try to change the place and time to locate an environment with good signal strength.
The unit turns off automatically.	<ul style="list-style-type: none"> • To prevent the situation of forgetting to turn off the power, this unit will turn off automatically after 10 days of continuous usage.
Unable to set focus.	<ul style="list-style-type: none"> • When not monitoring from a smartphone, the focus of the camera is fixed. • Even when monitoring from a smartphone, the focus of the camera will be fixed if not operated for more than 3 hours. (Focus works again when the camera is operated.)
Connection gets disconnected, or a "UNABLE TO CONNECT" message is displayed	<ul style="list-style-type: none"> • Establish a connection again at a place with good signal strength. Transmission speed may drop, or a connection may fail if the devices are placed too far away from each other, when there are objects in between, or when a microwave oven or other wireless devices are in use. • If a connection cannot be re-established, restart the terminal (smartphone). • You may have difficulty establishing a connection via direct monitoring in an environment where the camera is placed away from the smartphone. In this case, connect using the access point (wireless LAN router).

Access Point (Wireless LAN Router)

Trouble	Action
Unable to connect to access point (wireless LAN router).	<ul style="list-style-type: none"> • Check that the password is correct. • If the access point has been registered using the QR code, check that the SSID or authentication method is correct.
Unsure of which access point (wireless LAN router) to use.	<ul style="list-style-type: none"> • If the settings of the access point (wireless LAN router) have never been changed from their default values, check the following. <ul style="list-style-type: none"> - Check whether an adhesive label indicating the initial settings is attached to the body of the access point (wireless LAN router). - Check for the default settings in the instruction manual of the access point (wireless LAN router).
Unsure of password for the access point (wireless LAN router).	Refer to the instruction manual of the access point (wireless LAN router) in use.
Unable to connect via Wi-Fi Protected Setup (WPS).	<ul style="list-style-type: none"> • Simple connection methods other than WPS are not supported. Register an access point using QR code before making a connection. • Turn off the power of the camera, then try again.

INDOOR MONITORING (connection at home)

Trouble	Action
Unable to connect to camera.	<ul style="list-style-type: none"> • Check whether the Wi-Fi connection is established successfully. • Check to ensure that the camera and the terminal (smartphone) are connected to the same access point. • Try again after powering off and on the camera and the terminal (smartphone).
Video or audio is interrupted or delayed	<ul style="list-style-type: none"> • If the network speed is slow, videos and audio sound may be interrupted, or delay may become significant. • Try to change the place and time to locate an environment with good signal strength.
The unit turns off automatically.	<ul style="list-style-type: none"> • To prevent the situation of forgetting to turn off the power, this unit will turn off automatically after 10 days of continuous usage.
Unable to set focus.	<ul style="list-style-type: none"> • When not monitoring from a smartphone, the focus of the camera is fixed. • Even when monitoring from a smartphone, the focus of the camera will be fixed if not operated for more than 3 hours. (Focus works again when the camera is operated.)
Connection gets disconnected, or a "UNABLE TO CONNECT" message is displayed	<ul style="list-style-type: none"> • Establish a connection again at a place with good signal strength. Transmission speed may drop, or a connection may fail if the devices are placed too far away from each other, when there are objects in between, or when a microwave oven or other wireless devices are in use. • If a connection cannot be re-established, restart the terminal (smartphone).
Screen does not refresh or remains black	<ul style="list-style-type: none"> • Check if the camera and the access point are properly connected. Images cannot be detected on the terminal (smartphone) if the camera is disconnected from the access point halfway through.

OUTDOOR MONITORING (connection from the Internet)

Trouble	Action
The URL (WAN) does not appear in the network information.	<ul style="list-style-type: none"> • The URL (WAN) will not appear if dynamic DNS (DDNS) is not set on the camera. To set the dynamic DNS (DDNS), perform the following steps. <ol style="list-style-type: none"> 1. Obtain an account with JVC dynamic DNS (DDNS) service using your computer. 2. Log in to JVC DNS and obtain the dynamic DNS (DDNS) service. 3. Set the username and password for the dynamic DNS (DDNS) obtained on the camera. * Only the JVC dynamic DNS (DDNS) service can be set on this camera. • The URL (WAN) will not appear if dynamic DNS (DDNS) is not set on the camera. To set the dynamic DNS (DDNS), perform the following steps. <ol style="list-style-type: none"> 1. Obtain an account with JVC dynamic DNS (DDNS) service using your computer. https://dd3.jvckenwood.com/user/ 2. Log in to JVC DNS and obtain the dynamic DNS (DDNS) service. 3. Set the username and password for the dynamic DNS (DDNS) obtained on the camera. * Only the JVC dynamic DNS (DDNS) service can be set on this camera.
Unable to access the entered URL. (cannot be found)	<ul style="list-style-type: none"> • If there are two or more routers (or two or more routing functions) along the route between the camera and the WAN (global IP address), connection via internet cannot be used. • Check that the dynamic DNS username and password are correct. • The access point (wireless LAN router) in use is not compatible with UPnP, or UPnP is turned off. Check the instruction manual of the access point (wireless LAN router) in use, and turn on UPnP. • The "UPnP" of the camera is set to "OFF". (By default, it is set to "ON".) Generate a QR code and set "UPnP" to "ON". • Check whether a terminal that uses port 80 (such as web servers) has been set in the network, or if a specific terminal has been set to use port 80 on the access point (wireless LAN router). In such case, change the "HTTP Port" to other than 80 and generate a QR code. • Try again after powering off and on the camera and the terminal (smartphone).
Video or audio is interrupted or delayed	<ul style="list-style-type: none"> • If the network speed is slow, videos and audio sound may be interrupted, or delay may become significant. • Try to change the place and time to locate an environment with good signal strength.
The unit turns off automatically.	<ul style="list-style-type: none"> • To prevent the situation of forgetting to turn off the power, this unit will turn off automatically after 10 days of continuous usage.
Unable to set focus.	<ul style="list-style-type: none"> • When not monitoring from a smartphone, the focus of the camera is fixed. • Even when monitoring from a smartphone, the focus of the camera will be fixed if not operated for more than 3 hours. (Focus works again when the camera is operated.)
Connection gets disconnected, or a "UNABLE TO CONNECT" message is displayed	<ul style="list-style-type: none"> • Establish a connection again at a place with good signal strength. Transmission speed may drop, or a connection may fail if the devices are placed too far away from each other, when there are objects in between, or when a microwave oven or other wireless devices are in use. • If a connection cannot be re-established, restart the terminal (smartphone).
Screen does not refresh or remains black	<ul style="list-style-type: none"> • Check if the camera and the access point are properly connected. Images cannot be detected on the terminal (smartphone) if the camera is disconnected from the access point halfway through.
"XUPnP" is displayed.	<p>This appears when UPnP has failed.</p> <ul style="list-style-type: none"> • Check whether the wireless LAN router in use is compatible with UPnP. (Refer to the instruction manual of the wireless LAN router in use, or consult the manufacturer of the router.) • When the wireless LAN router in use is compatible with UPnP, turn on the UPnP function. • If the icon does not disappear even when the UPnP function is enabled, turn off and on the power of the wireless LAN router in use as well as the camera, then try again.
Unable to connect although "XUPnP" is displayed.	<ul style="list-style-type: none"> • When "UPnP" is set to "OFF", "XUPnP" will not appear. In such cases, set "UPnP" to "ON". • When the port 80 has been used by other devices via UPnP, a connection cannot be established. Reconnect the camera.

Vide/Still Image Transmission

Trouble	Action
Unable to transfer videos and still images to smartphone.	<ul style="list-style-type: none">• Check the amount of remaining free space in the destination medium (smartphone).

Wi-Fi Specifications

Wi-Fi Specifications

Item	Details
Wireless LAN Standard	IEEE802.11b/g/n (2.4GHz band)
Wi-Fi security	Encryption: WEP, WPA, WPA2 *WPA and WPA2 are supported only by the personal mode (PSK).

DIRECT MONITORING / INDOOR MONITORING / OUTDOOR MONITORING

■ When Using Everio sync. 2

Item	Details
Supported Terminals	iPhone/iPod touch: iOS 5.1 or later Android: Android 2.3 or later <ul style="list-style-type: none"> • There is no guarantee that the operations will work with all terminals. • “Everio sync. 2” for iPhone cannot be used when the iPhone is connected to the mobile phone network. To make use of this feature, connect to the camera or an access point via Wi-Fi. • A network environment with a minimum line speed of about 5.3 Mbps is recommended for both the camera sending the data and the smartphone terminal receiving the data. If the network speed is too low, video images may appear jumpy, or audio sound may be interrupted or delayed.
Monitor Screen	Video: JPEG 640x360 max. 12.5 fps Audio: linear PCM 8kHz 16 bits 1ch
Video Transmission	Video: MP4-compliant H.264 Baseline Profile 640x360 25p Audio: AAC 48kHz 16 bits 2ch
Still Image Transmission	JPEG format

Handling information: _____

The information you have entered is used to generate the QR code. The information is erased after the QR code is generated, and will not be retained on the web server. The QR code generated includes your information so please handle with care.

DIRECT MONITORING

You can check the image captured on the camera via direct 1-to-1 connection (Wi-Fi Direct) with a smartphone, without the need for an access point (wireless LAN router).

INDOOR MONITORING

You can check the image captured on the camera by connecting a smartphone via an access point (wireless LAN router).

OUTDOOR MONITORING

You can check the image captured on the camera via internet connection with a smartphone while you are outside.

Registering Access Point Manually

You can register an access point which does not support WPS.

DIRECT MONITORING

- **Setting (Once setting is done, start from the “Regular Operation” below)**

Creating a QR Code

- **Enter values in the required items for direct monitoring.**
- Password: set a password to connect this camera to the device by direct monitoring. (8 to 63 characters (64 characters in case of hexadecimal))
- Enforced Group Owner: setting used to enable a connection with a device that does not support Wi-Fi Direct. Normally set to “ON”.
- HTTP Port: Normally set to “80”.

Display the screen for reading the QR code.

- 1 Tap “MENU”.
(Operation on this camera)

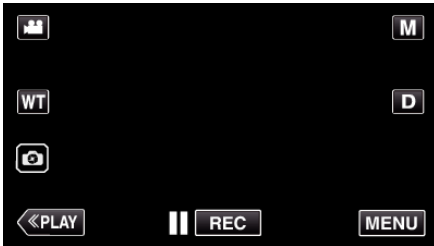

- The top menu appears.

- 2 Tap the “Wi-Fi” (Wi-Fi icon).
(Operation on this camera)

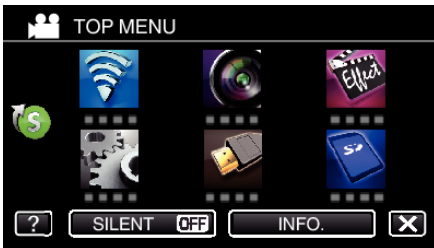

- 3 Tap “Wi-Fi SETTING”.
(Operation on this camera)



- 4 Tap “SET FROM QR CODE”.

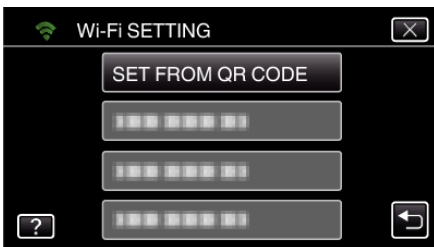

- 5 Tap “EXECUTE”.



Read a QR code.

- 1 Read a QR code.
(Operation on this camera)

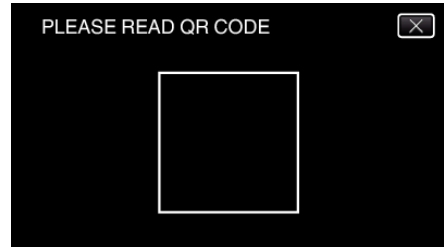

- 2 Tap “YES”.

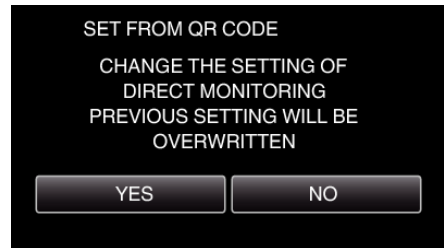

- 3 Tap “OK”.

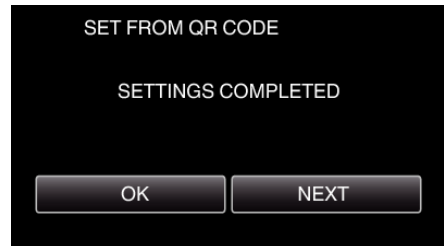

- Tap “NEXT” to return to the screen to read the QR code.
- Set contents are saved.

Regular Operation

Connecting the Smartphone to the Camera Wirelessly

Connection by entering the Wi-Fi password

- 1 Tap "MENU".
(Operation on this camera)
Set the camera to the recording mode.

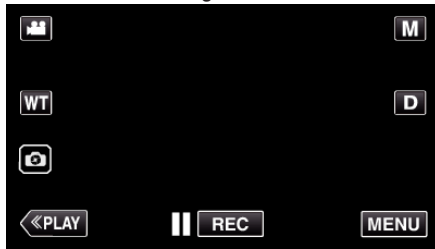

- The top menu appears.

- 2 Tap the "Wi-Fi" (Wi-Fi icon) icon.
(Operation on this camera)

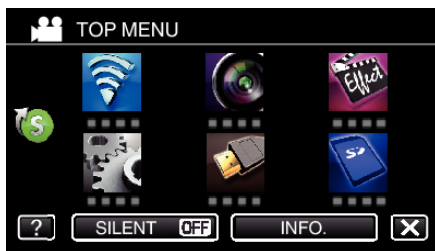

- 3 Tap the "DIRECT CONNECTION" (Wi-Fi icon) icon in the "Wi-Fi" menu.
(Operation on this camera)

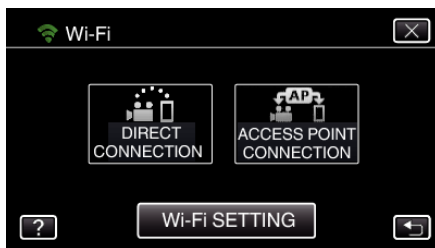

- When "50p" is selected for "SYSTEM SELECT", the following display appears and recording mode is switched to the 50i mode.
- This display disappears automatically after approximately 3 seconds, but disappears immediately if the screen is tapped.

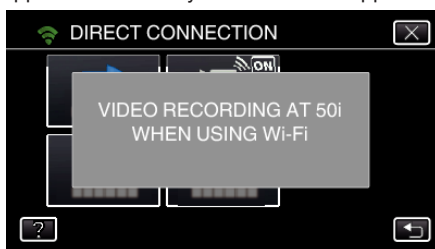

- 4 Check the SSID and the PASS being displayed on the screen of the camera.



- 5 Select the SSID in step 4 from the Wi-Fi network selection screen of your smartphone, and enter the PASS on the password screen.
(Operation on the smartphone)



- For details on connecting your smartphone to a Wi-Fi network, please refer to the instruction manual of the device in use.
- 6 A connection is established and Wi-Fi appears on the camera's screen.



Connection by Wi-Fi Protected Setup (WPS)

- 1 Tap "MENU".
(Operation on this camera)
Set the camera to the recording mode.

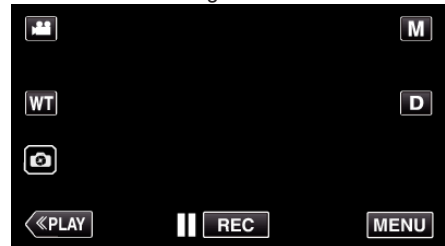

- The top menu appears.

- 2 Tap the "Wi-Fi" (Wi-Fi icon) icon.
(Operation on this camera)

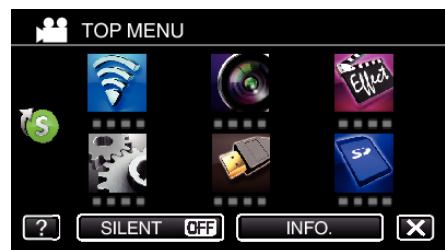

- 3 Tap the "DIRECT CONNECTION" (Wi-Fi icon) icon in the "Wi-Fi" menu.
(Operation on this camera)



- When "50p" is selected for "SYSTEM SELECT", the following display appears and recording mode is switched to the 50i mode.
- This display disappears automatically after approximately 3 seconds, but disappears immediately if the screen is tapped.



- 4 Tap "WPS".
(Operation on this camera)



- 5 Activate WPS on the smartphone within 2 minutes.
(Operation on the smartphone)



- To activate WPS, refer to the instruction manual of the device in use.

- 6 A connection is established and appears on the camera's screen.



Monitoring Images from Smartphone

Smartphone (Android / iPhone)

Memo : _____

- Prior to use this function, a smartphone application needs to be installed on the smartphone.

"Installing Smartphone Applications" (☞ p. 119)

- 1 Start "Everio sync. 2" on the smartphone after setting DIRECT MONITORING.



- 2 Tap "DIRECT MONITORING".



- 3 The recording screen is displayed.



- 4 Operate from a smartphone



- How to operate from a smartphone
"Using Smartphone Applications" (☞ p. 119)

INDOOR MONITORING

- **Setting (Once setting is done, start from the “Regular Operation” below)**

Creating a QR Code

- **Enter values in the required items for indoor monitoring.**

- For indoor monitoring, it is not necessary to perform settings other than the password and HTTP port.
Items other than the above mentioned are used for “OUTDOOR MONITORING”. When using outdoor monitoring, enter each item and perform the settings again.
If connection fails, check that the contents entered for each item are correct, regenerate the QR code and set the camera.
- Password: set a password to connect this camera to the device via an access point. (Not more than 8 characters)
- DDNS: Set the connection environment to the internet. Set to OFF when outdoor monitoring is not used.
- User name (DDNS): set an user name for the obtained DDNS account.
- Password (DDNS): set a password for the obtained DDNS account.
- UPnP: Set to “ON” if the UPnP protocol may be used to connect the device to the network.
- HTTP Port: Set the port number for connecting to the internet. Normally set to “80”.

Display the screen for reading the QR code.

- 1 Tap “MENU”.
(Operation on this camera)

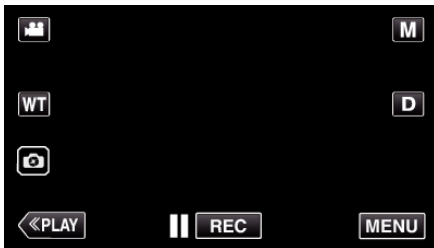

- The top menu appears.

- 2 Tap the “Wi-Fi” (📶) icon.
(Operation on this camera)



- 3 Tap “Wi-Fi SETTING”.
(Operation on this camera)

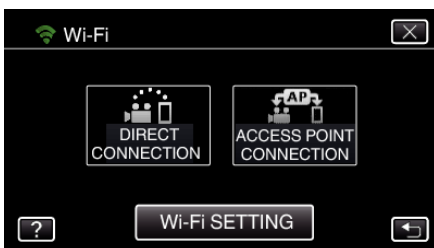

- 4 Tap “SET FROM QR CODE”.

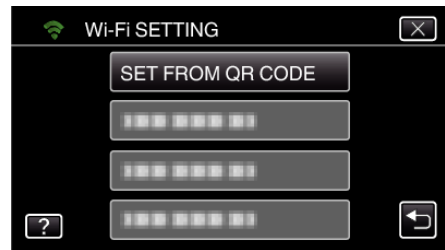

- 5 Tap “EXECUTE”.



Read a QR code.

- 1 Read a QR code.
(Operation on this camera)

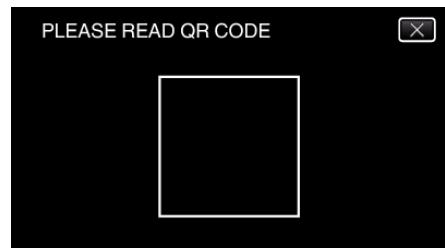

- 2 Tap “YES”.

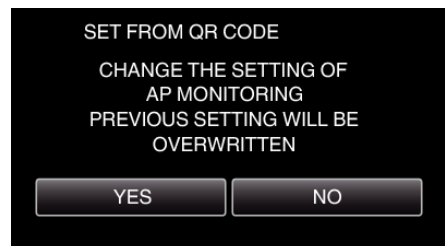

- 3 Tap “OK”.

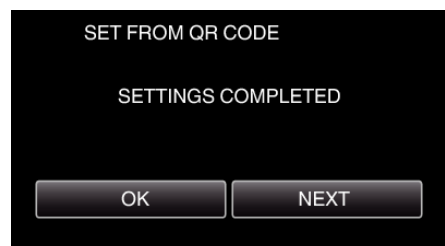

- Tap “NEXT” to return to the screen to read the QR code.
- Set contents are saved.

Registering the access points (wireless LAN router) to this unit

■ Wi-Fi Protected Setup (WPS) Registration

- 1 Tap “MENU”.
(Operation on this camera)

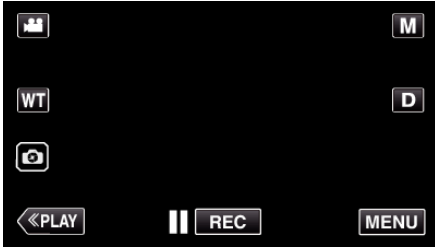

- The top menu appears.

- 2 Tap the “Wi-Fi” (📶) icon.
(Operation on this camera)

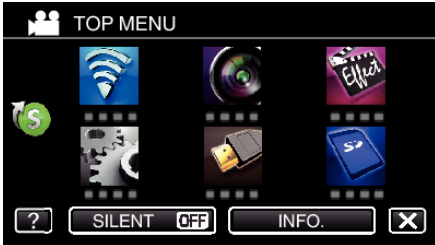

- 3 Tap “Wi-Fi SETTING”.
(Operation on this camera)

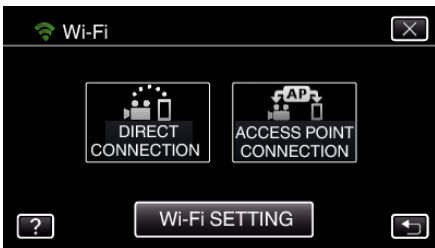

- 4 Tap “ACCESS POINTS”.
(Operation on this camera)

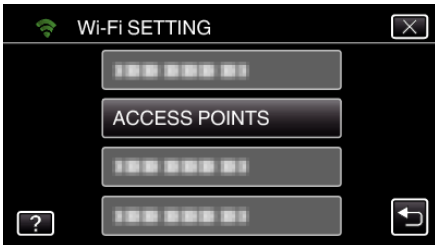

- 5 Tap “ADD”.
(Operation on this camera)



- 6 Tap “EZ REGISTRATION WPS”.
(Operation on this camera)

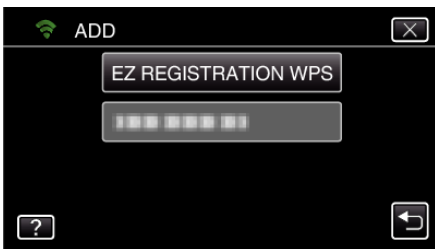

- 7 Activate WPS of the access point (wireless LAN router) within 2 minutes.
- To activate WPS, refer to the instruction manual of the device in use.

- 8 After registration is complete, tap “OK” on the camera’s screen.
(Operation on this camera)



- The following registration methods are also available.
“Registering Access Point Using WPS PIN” (☞ p. 117)
“Registering Access Point Manually” (☞ p. 146)

Connecting Smartphone to Access Point (Wireless LAN Router)

- Connect the smartphone to the access point (wireless LAN router) at home.
- This setting is not required if the smartphone has already been connected to the access point (wireless LAN router) at home.

■ Regular Operation

Monitoring the images by connecting the smartphone and the camera

■ Operation on this camera

- 1 Tap "MENU".
(Operation on this camera)



- The top menu appears.

- 2 Tap the "Wi-Fi" (Wi-Fi icon).
(Operation on this camera)

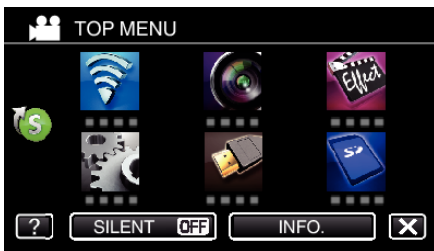

- 3 Tap "ACCESS POINT CONNECTION".
(Operation on this camera)

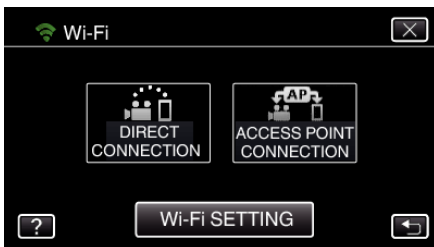

- 4 Start making a connection.
(Operation on this camera)

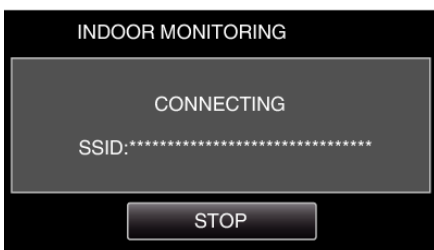

- Name (SSID) of the access point (wireless LAN router) in connection is displayed.

- 5 The following is displayed when the camera is connected to the access point.



■ Operation on the smartphone

Memo :

- Prior to use this function, a smartphone application needs to be installed on the smartphone.

"Installing Smartphone Applications" (p. 119)

- 1 Start "Everio sync. 2" on the smartphone after setting "INDOOR MONITORING".



- Tap "START" in INDOOR MONITORING on the camera to start.

- 2 Tap "INDOOR MONITORING".



- 3 The recording screen is displayed.



- How to operate from a smartphone
“Using Smartphone Applications” (p. 119)

OUTDOOR MONITORING

- **Setting (Once setting is done, start from the “Regular Operation” below)**

Obtaining a Dynamic DNS (DDNS) Account

By obtaining a dynamic DNS account, this unit may be used on the web as usual even if the IP address changes when making an access to this unit via internet.

- Only the JVC dynamic DNS service can be set on this camera.

To obtain (register) an account, perform the following steps.

- 1 Access the following URL from a browser and register for an account. (Operation on a computer or smartphone)
<https://dd3.jvckenwood.com/user/>
Set your e-mail address as the username.
- 2 Check that you have received a confirmation e-mail to the address used in registration, and access the URL stated in the e-mail. (Operation on a computer or smartphone)
- 3 Set the username and password used in registration on the camera. (Operation on this camera)
Generate the QR code, and register the username and password to the camera.
- 4 Execute ACCESS POINT CONNECTION. (Operation on this camera)
If “ACCESS POINT CONNECTION” is executed while dynamic DNS settings are enabled, the camera will access the dynamic DNS server.
- 5 Tap “INFO.” to check that the URL (WAN) is displayed. (Registration complete)

Caution :

- Registration will be canceled if you do not access the dynamic DNS server from the camera within 3 days.
Perform the registration again in this case.
- Registration will not be complete if the username and password set on this camera are incorrect. Be sure to check that they are correct.
- Successful registration will be canceled too if you do not access the dynamic DNS server for 1 year.

Creating a QR Code

- **Enter values in the required items for outdoor monitoring.**

- All items will be overwritten and set. Enter all the required items.
If connection fails, check that the contents entered for each item are correct, regenerate the QR code and set the camera.
- Password: set a password to connect this camera to the device via an access point. (Not more than 8 characters)
- DDNS: Set the connection environment to the internet. Normally set to “ON”.
- User name (DDNS): set an user name for the obtained DDNS account.
- Password (DDNS): set a password for the obtained DDNS account.
- UPnP: Set to “ON” if the UPnP protocol may be used to connect the device to the network.
- HTTP Port: Set the port number for connecting to the internet. Normally set to “80”.

Display the screen for reading the QR code.

- 1 Tap "MENU".
(Operation on this camera)

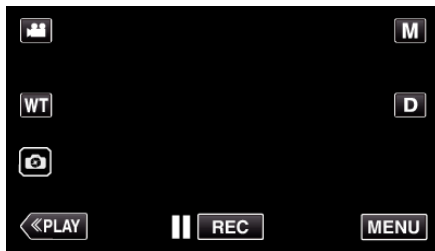

- The top menu appears.

- 2 Tap the "Wi-Fi" (Wi-Fi icon).
(Operation on this camera)



- 3 Tap "Wi-Fi SETTING".
(Operation on this camera)

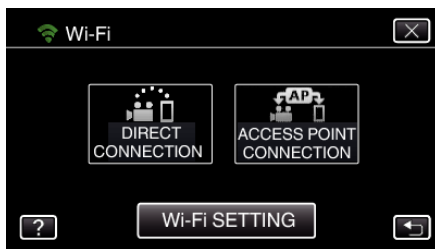

- 4 Tap "SET FROM QR CODE".

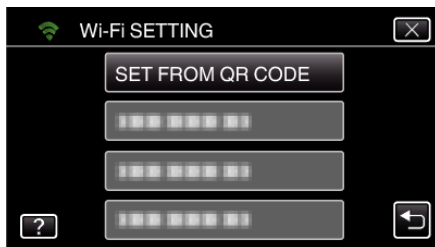

- 5 Tap "EXECUTE".

**Read a QR code.**

- 1 Read a QR code.
(Operation on this camera)

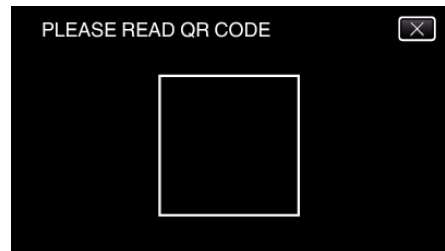

- 2 Tap "YES".

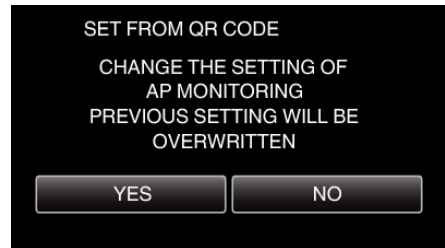

- 3 Tap "OK".

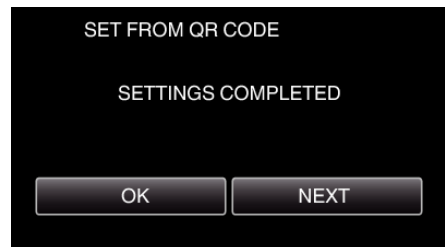

- Tap "NEXT" to return to the screen to read the QR code.
- Set contents are saved.

Registering the access points (wireless LAN router) to this unit**■ Wi-Fi Protected Setup (WPS) Registration**

- 1 Tap "MENU".
(Operation on this camera)

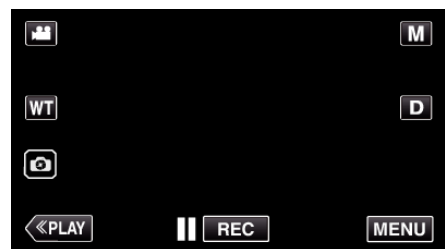

- The top menu appears.

- 2 Tap the "Wi-Fi" (Wi-Fi icon).
(Operation on this camera)

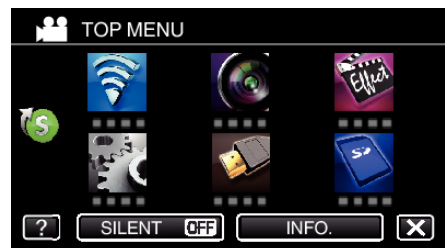

- 3 Tap "Wi-Fi SETTING".
(Operation on this camera)

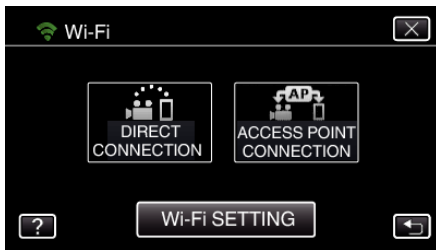

- 4 Tap "ACCESS POINTS".
(Operation on this camera)

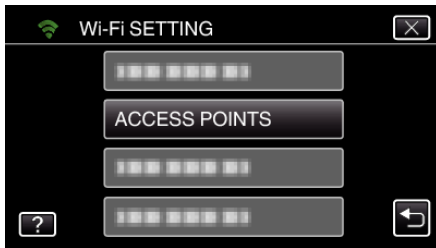

- 5 Tap "ADD".
(Operation on this camera)



- 6 Tap "EZ REGISTRATION WPS".
(Operation on this camera)

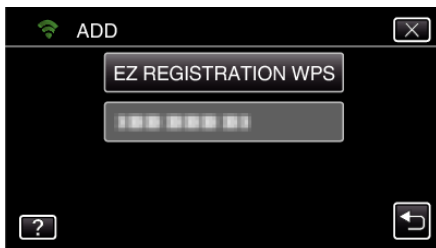

- 7 Activate WPS of the access point (wireless LAN router) within 2 minutes.
 - To activate WPS, refer to the instruction manual of the device in use.
- 8 After registration is complete, tap "OK" on the camera's screen.
(Operation on this camera)



- The following registration methods are also available.
"Registering Access Point Using WPS PIN" (p. 117)
"Registering Access Point Manually" (p. 146)

Regular Operation

Connecting the Camera to the Smartphone

- 1 Tap "MENU".
(Operation on this camera)

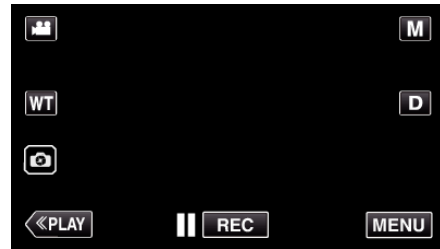

- The top menu appears.

- 2 Tap the "Wi-Fi" (Wi-Fi icon).
(Operation on this camera)

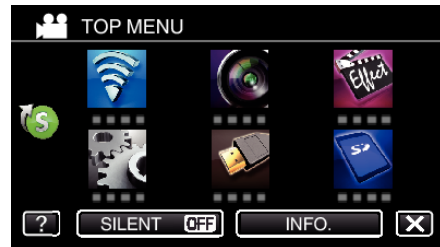

- 3 Tap "ACCESS POINT CONNECTION".
(Operation on this camera)

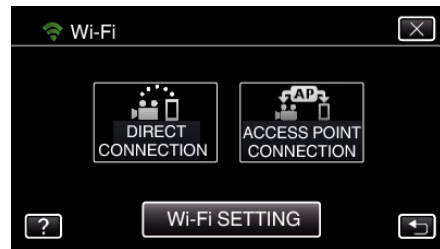

- 4 Start making a connection.
(Operation on this camera)



- Name (SSID) of the access point (wireless LAN router) in connection is displayed.

- 5 The following is displayed when the camera is connected to the access point.

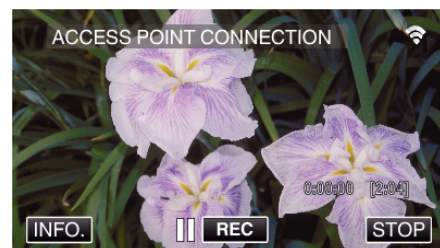

- Tapping "INFO." displays the URL (WAN) for connecting the smartphone.
(Does not appear if DDNS is not set or set incorrectly.)
- "XUPnP" is displayed when UPnP cannot be used.

Operation on the smartphone

Memo :

- Prior to use this function, a smartphone application needs to be installed on the smartphone.

“Installing Smartphone Applications” (☞ p. 119)

- 1 Start “Everio sync. 2” on the smartphone after setting OUTDOOR MONITORING.



- Tap “START” in OUTDOOR MONITORING on the camera to start.

- 2 Tap “OUTDOOR MONITORING”.



- 3 Set the URL.

- It is necessary to set the URL when you are using this feature for the first time. Enter the URL displayed on the camera.
- If this screen is displayed after the URL has been set, check the connection status of the internet or the camera settings.

- 4 Log in with your username and password.
(if authentication cannot be achieved)

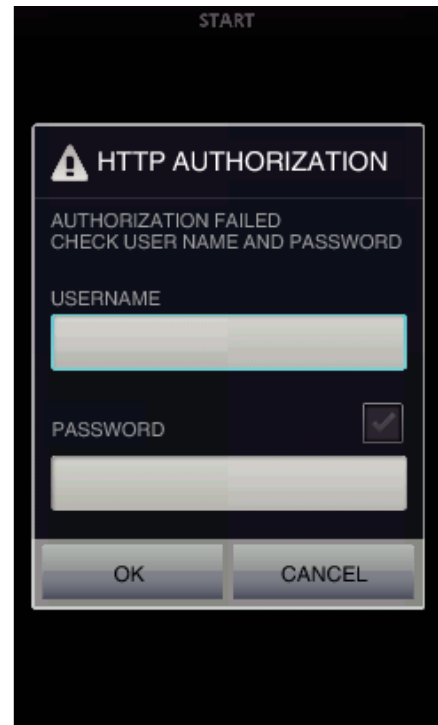

- The username is “everio” and the default password is “0000”.
- To change the password, it is necessary to generate a QR code. “Creating a QR Code” (☞ p. 142)

- 5 The recording screen is displayed.



- 6 Operate from a smartphone



- How to operate from a smartphone
“Using Smartphone Applications” (☞ p. 119)

Registering Access Point Manually

Creating a QR Code

■ Enter the items required for registering the access point

- All items will be overwritten and set. Enter all the required items.
- SSID: Set the identification name (SSID) of the access point.
- Security Authentication: Set the encryption standard for communication security.
- Password: Set the password for the access point.
- DHCP: Specify whether to obtain the required information for internet connection automatically from the DHCP server (ON) or not (OFF).
- When DHCP is set to ON, it is not necessary to set the items following the IP address.
- IP Address: Set the information on internet connection (IP address) of the camera.
- Subnet Mask: Set the information on internet connection (subnet mask) of the camera.
- Default Gateway: Set the information on internet connection (default gateway) of the camera.
- Primary DNS: Set the information on internet connection (primary DNS) of the camera.
- Secondary DNS: Set the information on internet connection (secondary DNS) of the camera.

Display the screen for reading the QR code.

- 1 Tap "MENU".
(Operation on this camera)

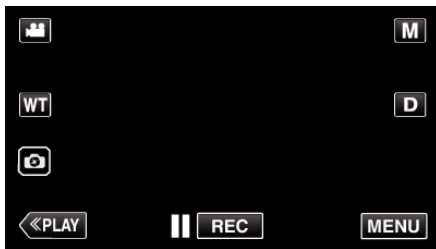

- The top menu appears.

- 2 Tap the "Wi-Fi" (Wi-Fi icon).
(Operation on this camera)

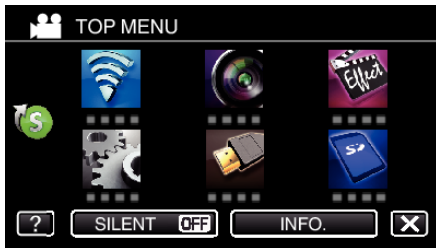

- 3 Tap "Wi-Fi SETTING".
(Operation on this camera)

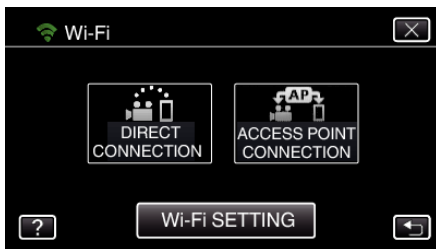

- 4 Tap "SET FROM QR CODE".



- 5 Tap "EXECUTE".



Read a QR code.

- 1 Read a QR code.
(Operation on this camera)

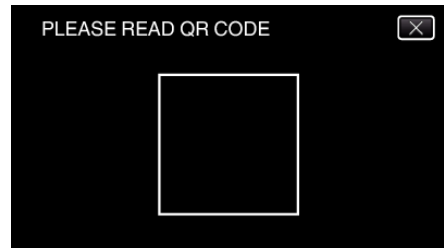

- 2 Tap "YES".

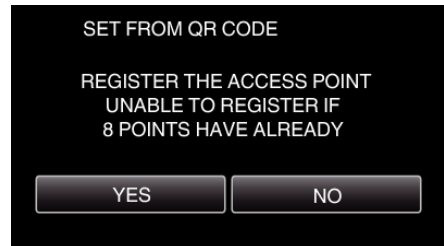

- 3 Tap "OK".

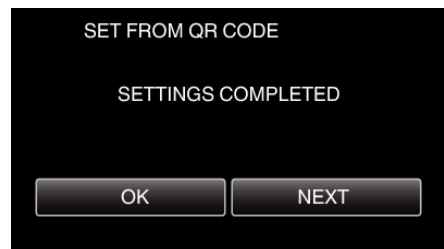

- Tap "NEXT" to return to the screen to read the QR code.
- Set contents are saved.

Operating the Menu

There are two types of menus in this unit.

- **TOP MENU:** Menu that contains all the items specific to the video recording, still image recording, video playback, and still image playback modes respectively.
- **SHORTCUT MENU:** Menu that contains the recommended functions for video/still image recording.

Operating the Top Menu

You can configure various settings using the menu.

- 1 Tap "MENU".

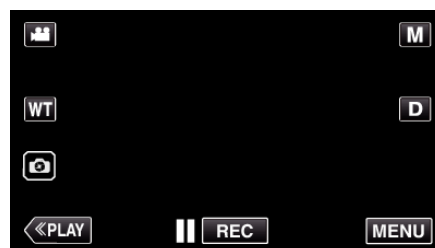

- The top menu appears.
- The menu differs according to the mode in use.

- 2 Tap the desired menu.

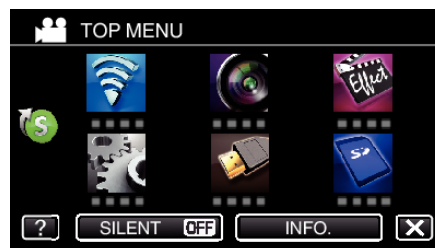

- 3 Tap the desired setting.



Memo :

- To display the previous/next menu
Tap < or >.
- To return to the previous screen
Tap ↶.
- To exit the screen
Tap X (quit).
- To display the help file
Tap ? (help) and tap the item.
Help file may not be available for some items.

Operating the Shortcut Menu



You can configure various settings of the recommended functions in the video/still image recording mode using the shortcut menu.

- 1 Tap "MENU".

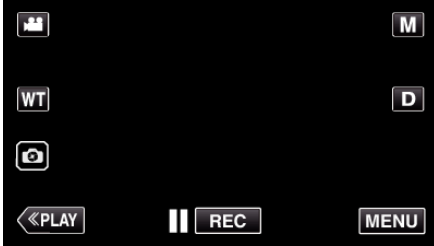

- 2 Tap the shortcut icon (S).



- The shortcut menu appears.

- 3 Tap the desired menu and setting.

<Shortcut Menu During Video Recording Mode>

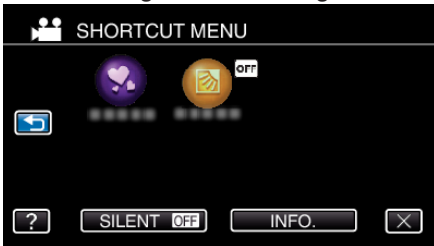

- Allows settings of "ANIMATION EFFECT" and "BACKLIGHT COMP. (manual mode only)".

<Shortcut Menu During Still Image Recording Mode>



- "BACKLIGHT COMP. (manual mode only) " can be set.

Memo :

- To return to the top menu

Tap ↵ (return).

- To exit the screen

Tap × (quit).

- To display the help file

Tap ? (help) and tap the item.

Shortcut Menu (video/still image)



BACKLIGHT COMP.

Corrects the image when the subject appears dark due to backlight.

“Setting Backlight Compensation” (☰ p. 31)

*Displayed only in the manual recording mode.

RECORD SETTING Menu (video)



FOCUS

Focus can be adjusted manually.

“Adjusting Focus Manually (FOCUS)” (☞ p. 29)

*Displayed only in the manual recording mode.

BRIGHTNESS ADJUST

Adjusts the overall brightness of the screen.

“Adjusting Brightness” (☞ p. 30)

*Displayed only in the manual recording mode.

BACKLIGHT COMP.

Corrects the image when the subject appears dark due to backlight.

“Setting Backlight Compensation” (☞ p. 31)

*Displayed only in the manual recording mode.

WHITE BALANCE

Adjusts the color according to the light source.

“Setting White Balance” (☞ p. 32)

*Displayed only in the manual recording mode.

TELE MACRO

Enables close-up shots when using the telephoto (T) end of the zoom.

“Taking Close-up Shots (TELE MACRO)” (☞ p. 33)

*Displayed only in the manual recording mode.

TOUCH PRIORITY AE/AF

Automatically adjusts focus and brightness based on the subjects' faces or selected area.

“Capturing Subjects Clearly (TOUCH PRIORITY AE/AF)” (☞ p. 42)

LIGHT (GZ-RX115)

Turns on/off the light.

Setting	Details
OFF	Does not light up.
AUTO	Lights up automatically when the surrounding is dark.
ON	Lights up at all times.

DIS

Camera shake during video recording can be effectively reduced.

“Reducing Camera Shake” (☞ p. 43)

GAIN UP

Makes the subject appear bright automatically when recording in dark places.

Setting	Details
OFF	Deactivates the function.
ON	Electrically brightens the scene when it is dark.
AUTO SLOW-SHUTTER	Slows down the shutter speed to brighten the scene when it is dark.

Memo :

- Although "AUTO SLOW-SHUTTER" brightens the scene more than "ON", movements of the subject may become unnatural.

WIND CUT

Reduces the noise caused by wind.

Setting	Details
OFF	Deactivates the function.
ON	Activates the function.
AUTO	Activate the function automatically.

SHUTTER MODE

Continuous shooting settings can be adjusted.

Setting	Details
RECORD ONE SHOT	Records one still image.
CONTINUOUS SHOOTING	Records still images continuously while the  button on the LCD screen is tapped.

Memo :

- The size of the still image that is captured in the video mode is 1,920 x 1,080.
- Some SD cards may not support continuous shooting.
- The continuous shooting speed will drop if this function is used repeatedly.

SEAMLESS RECORDING

Continues recording on the SD card without stopping when the remaining space on the built-in memory runs out.

Setting	Details
OFF	Does not switch recording media automatically.
ON	Switches recording media automatically.

Memo :

- Seamless recording cannot be performed if there is not enough free space in the SD card.
-  appears if seamless recording cannot be performed.
- To start seamless recording again after the previous session is complete, it is necessary to combine seamless videos, or delete the combination information of the seamless videos.

"Combining Videos Recorded by Seamless Recording" ( p. 65)

- Wi-Fi mode does not support seamless recording.

Settings Menu

SYSTEM SELECT

Sets the frame rate for recording.

Setting	Details
50p	Records in progressive format.
50i	Does not record in progressive format.

Memo :

- Video quality cannot be set in 50p mode.
 - Videos recorded in 50p are playable only on AVCHD Progressive compatible devices.
 - Blu-ray discs containing videos that are recorded in 50p mode are playable only on AVCHD Progressive compatible devices.
-

VIDEO QUALITY

Sets the video quality.

Setting	Details
UXP	Enables recording in the best picture quality. <ul style="list-style-type: none">• Applies to Blu-ray discs only. Videos taken in high-definition quality cannot be saved to DVDs.
XP	Enables recording in high picture quality.
EP	Enables long recordings.

Memo :

- Set to "UXP" or "XP" mode when recording fast-moving scenes or scenes with extreme changes of brightness to avoid noise.
 - Use an BD writer (external Blu-ray drive) to save videos recorded in "UXP" mode or in DVD-Video format (standard quality).
-

ZOOM

Sets the maximum zoom ratio.

Setting	Details
40x OPTICAL	Enables recording with 1 - 40x optical zoom. Set this when digital zoom is not desired.
60x DYNAMIC (55x DYNAMIC)	Enables recording with 1 - 40x optical zoom and 41 - 60x dynamic zoom, when the image stabilizer is in normal mode or set to off. (Enables recording with 1 - 40x optical zoom and 41 - 55x dynamic zoom, when the image stabilizer is in active mode.)
120x DIGITAL	Enables recording with 1 - 40x optical zoom and 41 - 120x digital zoom.
200x DIGITAL	Enables recording with 1 - 40x optical zoom and 41 - 200x digital zoom.

Memo :

- When digital zoom is used, the image becomes grainy as it is digitally enlarged.
 - The angle of view changes when the image stabilizer is turned on or off.
-

ZOOM MIC

Sets the zoom microphone.

Setting	Details
OFF	Deactivates the zoom microphone.
ON	Records audio sounds in the same direction as the zoom operation.

Memo :

- When "ON" is selected, the volume of the wide angle (W) end is lower than the telephoto (T) end.

MIC LEVEL

Make the adjustments such that "MIC LEVEL" does not turn red.

Setting	Details
OFF	Hides display of microphone input level.
ON	Shows display of microphone input level.

MIC LEVEL SETTING

Sets the microphone level.

Make the adjustments such that "MIC LEVEL" does not turn red.

Setting	Details
+1	Increases the microphone input level.
0	The microphone input level is not changed.
-1	Decreases the microphone input level.

K2 TECHNOLOGY

Reduces the degradation of sound quality caused by digital signal processing, and records a sound quality close to the original.

Setting	Details
OFF	Deactivates K2 TECHNOLOGY.
ON	Activates K2 TECHNOLOGY.

SCREEN LOCK

When shooting under water, lock the touch screen to prevent operation errors.

"Locking the Screen (when Shooting Underwater)" (p. 12)

SPECIAL RECORDING Menu (video)



TIME-LAPSE RECORDING

This function enables the changes of a scene that occur slowly over a long period to be shown within a short time by taking frames of it at a certain interval. This is useful for making observations such as the opening of a flower bud.

“Recording at Intervals (TIME-LAPSE RECORDING)” (☞ p. 44)

ANIMATION EFFECT

Records videos with animation effects.

“Recording with Animation Effects (ANIMATION EFFECT)” (☞ p. 39)

RECORDING EFFECT

You can add and record various effects to the images. Once setting is done, you can easily record images that are suitable for each image.

■ GRAINY MONOCHROME

You can record images with a grainy black and white photo feel.

“Recording Images Like an Old Black and White Photo (GRAINY MONOCHROME)” (☞ p. 36)

■ FOOD

You can capture images of the food to make the food look appetizing.

“Recording Food Images (FOOD)” (☞ p. 37)

■ BABY

You can capture soft images by enhancing the clarity and brightness of skin color. This effect is suitable for capturing images of a baby.

“Recording Images of a Baby (BABY)” (☞ p. 38)

DATE/TIME RECORDING

You can record videos together with the date and time.

Set this when you want to save the file with date and time display.

(The date and time cannot be deleted after recording.)

“Recording Videos with Date and Time” (☞ p. 46)

RECORD SETTING Menu (still image)



FOCUS

Focus can be adjusted manually.

“Adjusting Focus Manually (FOCUS)” (☞ p. 29)

*Displayed only in the manual recording mode.

BRIGHTNESS ADJUST

Adjusts the overall brightness of the screen.

“Adjusting Brightness” (☞ p. 30)

*Displayed only in the manual recording mode.

BACKLIGHT COMP.

Corrects the image when the subject appears dark due to backlight.

“Setting Backlight Compensation” (☞ p. 31)

*Displayed only in the manual recording mode.

WHITE BALANCE

Adjusts the color according to the light source.

“Setting White Balance” (☞ p. 32)

*Displayed only in the manual recording mode.

TELE MACRO

Enables close-up shots when using the telephoto (T) end of the zoom.

“Taking Close-up Shots (TELE MACRO)” (☞ p. 33)

*Displayed only in the manual recording mode.

TOUCH PRIORITY AE/AF

Automatically adjusts focus and brightness based on the subjects' faces or selected area.

“Capturing Subjects Clearly (TOUCH PRIORITY AE/AF)” (☞ p. 42)

LIGHT

Turns on/off the light.

Setting	Details
OFF	Does not light up.
AUTO	Lights up automatically when the surrounding is dark.
ON	Lights up at all times.

SELF-TIMER

Use this when taking a group photo.

“Taking Group Shots (Self-timer)” (☞ p. 45)

Settings Menu

GAIN UP

Makes the subject appear bright automatically when recording in dark places.

Setting	Details
OFF	Deactivates the function.
ON	Electrically brightens the scene when it is dark.

Memo :

- Setting can be adjusted separately for videos.

“GAIN UP (Video)” (☞ p. 151)

SHUTTER MODE

Continuous shooting settings can be adjusted.

Setting	Details
RECORD ONE SHOT	Records one still image.
CONTINUOUS SHOOTING	Records still images continuously while the START/STOP button is pressed. Records still images continuously while the START/STOP button is pressed, or while the  button on the LCD screen is tapped.

Memo :

- Some SD cards may not support continuous shooting.
- The continuous shooting speed will drop if this function is used repeatedly.

IMAGE SIZE

Sets the image size (number of pixels) for still images.

Setting	Details
1920X1080(2M)	Takes still images with aspect ratio 16:9. <ul style="list-style-type: none">• The sides of still images recorded in 16:9 aspect ratio may be cut off when printed.
3680X2760(10.15M) 1440X1080(1.5M) 640X480(0.3M)	Takes still images with aspect ratio 4:3.

SCREEN LOCK

When shooting under water, lock the touch screen to prevent operation errors.

“Locking the Screen (when Shooting Underwater)” (☞ p. 12)

SPECIAL RECORDING Menu (still image)



RECORDING EFFECT

You can add and record various effects to the images. Once setting is done, you can easily record images that are suitable for each image.

■ GRAINY MONOCHROME

You can record images with a grainy black and white photo feel.

“Recording Images Like an Old Black and White Photo (GRAINY MONOCHROME)” (p. 36)

■ FOOD

You can capture images of the food to make the food look appetizing.

“Recording Food Images (FOOD)” (p. 37)

■ BABY

You can capture soft images by enhancing the clarity and brightness of skin color. This effect is suitable for capturing images of a baby.

“Recording Images of a Baby (BABY)” (p. 38)

PLAYBACK SETTING Menu (video)



DISPLAY DATE/TIME

Sets whether to display the recording date and time during video playback.

Setting	Details
OFF	Does not display the date and time during playback.
ON	Displays the date and time during playback.

DIGEST PLAYBACK

Plays back a digest of the recorded videos.

“DIGEST PLAYBACK” (p. 53)

PLAYBACK PLAYLIST

Plays back the playlists registered in Digest Playback.

“PLAYBACK PLAYLIST” (p. 54)

PLAYBACK OTHER FILE

Plays videos with defective management information.

“PLAYBACK OTHER FILE” (p. 55)

EDIT Menu (video)



PROTECT/CANCEL

Protects files from being deleted accidentally.

“Protecting/Releasing Protection of the Currently Displayed File” (☞ p. 62)

“Protecting/Releasing Protection of Selected Files” (☞ p. 63)

COPY

Copies files from the built-in memory to the SD card.

“Copying Files to an SD Card” (☞ p. 91)

TRIMMING

Select the required part of a video and save it as a new video file.

The original video remains in its existing location.

“Capturing a Required Part in the Video (TRIMMING)” (☞ p. 66)

SEAMLESS REC CTRL

Videos that are recorded on two separate media and with “SEAMLESS RECORDING” in the video recording menu enabled can be combined into a single video.

“Combining Videos Recorded by Seamless Recording” (☞ p. 65)

PLAYBACK SETTING Menu (still image)



SLIDE SHOW EFFECTS

Sets the transition effects in slideshow playback.

Setting	Details
SLIDE	Switches the screen by sliding in from right to left.
BLINDS	Switches the screen by dividing into vertical strips.
CHECKERBOARD	Switches the screen by changing through a checkered pattern.
RANDOM	Switches the screen with a random effect from SLIDE, "BLINDS", and "CHECKERBOARD".

Memo :

- Slideshow effects are not available when playing back still images in external devices (such as USB external hard disk drives).
-

EDIT Menu (still image)



PROTECT/CANCEL

Protects files from being deleted accidentally.

“Protecting/Releasing Protection of the Currently Displayed File” (☞ p. 62)

“Protecting/Releasing Protection of Selected Files” (☞ p. 63)

COPY

Copies files from the built-in memory to the SD card.

“Copying Files to an SD Card” (☞ p. 91)

SETUP (video/still image)



Mobile User Guide

Displays the QR code to access the Mobile User Guide.

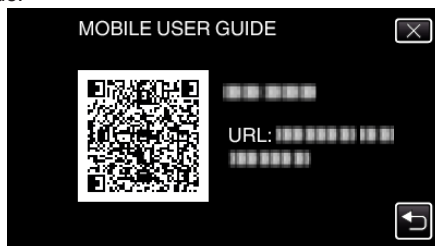

- The portal site appears when the QR code has been read correctly.
Select the model name of your camera to display its Mobile User Guide.

Memo :

- To read the QR code, a relevant application is required. Enter the URL in the internet browser manually if the QR code cannot be read.
- The Mobile User Guide is supported by Android devices and iPhone. You can view it on standard browsers such as Google Chrome (Android) and Mobile Safari (iPhone).
- QR Code is a registered trademark of Denso Wave Incorporated.

DATE & TIME

Resets the current time or sets to the local time when using this unit overseas.

“Clock Setting” (☞ p. 16)

“Setting the Clock to Local Time when Traveling” (☞ p. 20)

“Setting Daylight Saving Time” (☞ p. 20)

DATE DISPLAY STYLE

Sets the order of year, month, day and the time display format (24H/12H).

Sorting Order	Time Display
month.day.year	12h
year.month.day	24h
day.month.year	-

LANGUAGE

The language on the display can be changed.

“Changing the Display Language” (☞ p. 18)

MONITOR BRIGHTNESS

Sets the brightness of the LCD monitor.

Setting	Details
AUTO	Sets the brightness automatically to “4” when using outdoors and to “3” when using indoors.
4	Brightens the backlight of the monitor regardless of the surrounding conditions.
3	Sets to the standard brightness.
2	Darkens the backlight of the monitor regardless of the surrounding conditions.
1	Sets to dim brightness. Helps to save battery life when selected.

OPERATION SOUND

Turns on or off the operation sound.

Setting	Details
OFF	Turns off the operation sound.
ON	Turns on the operation sound.

AUTO POWER OFF

When no operation is made for 5 minutes, this function turns off this unit or sets this unit to standby mode when using the AC adapter in case you forgot to turn off the power.

Setting	Details
OFF	Power is not turned off even if this unit is not operated for 5 minutes.
ON	Turns off the power automatically if this unit is not operated for 5 minutes.

Memo :

- Turns off the power automatically if this unit is not operated for 5 minutes.
- When using the AC adapter, this unit goes into standby mode.

DEMO MODE

Plays a demonstration of the special features of this unit.

Setting	Details
OFF	Deactivates the function.
ON	Plays a demonstration of the special features of this unit.

Memo :

- This mode is not available in the playback mode.

TOUCH SCREEN ADJUST

Adjusts the response position of the buttons on the touch screen.
 “Adjusting the Touch Panel” (p. 12)

FACTORY PRESET

Returns all the settings to their default values.

FIRMWARE UPDATE

Updates the functions of this unit to the latest version.
 For details, refer to the JVC homepage.

(When no program to update the software of this unit is available, nothing will be provided on the homepage.)

<http://www3.jvckenwood.com/english/support/index.html>

OPEN SOURCE LICENSES (recording only)

Displays the open source software licenses that are used in this unit.

CONNECTION SETTINGS (video/still image)



DISPLAY ON TV

Displays icons and date/time on a TV screen.

Setting	Details
OFF	Does not display icons and date/time on TV.
ON	Displays icons and date/time on TV.

VIDEO OUTPUT

Sets the aspect ratio (16:9 or 4:3) according to the connecting TV.

Setting	Details
4:3	Select this when connecting to a conventional TV (4:3).
16:9	Select this when connecting to a widescreen TV (16:9).

HDMI OUTPUT

Sets the output from the HDMI connector of this unit when it is connected to a TV.

Setting	Details
AUTO	It is recommended to select "AUTO" usually.
480p	Select this when the video is not output in "AUTO" correctly.

HDMI CONTROL

Sets whether to link operations with an HDMI-CEC compliant TV.



Setting	Details
OFF	Turns off linked operations.
ON	Turns on linked operations.

MEDIA SETTINGS (video/still image)





REC MEDIA FOR VIDEO

Sets the recording/playback media of videos.

Setting	Details
 BUILT-IN MEMORY	Records videos to this unit's built-in memory.
 SD CARD	Records videos to the SD card.

REC MEDIA FOR IMAGE

Sets the recording/playback media of still images.

Setting	Details
 BUILT-IN MEMORY	Records still images to this unit's built-in memory.
 SD CARD	Records still images to the SD card.

FORMAT BUILT-IN MEM.

Deletes all files on the built-in memory.

Setting	Details
FILE	Deletes all files on the built-in memory. The folder and file numbers won't be reset. (The folder and file numbers of newly recorded files will continue from the last number of the deleted files.)
FILE + MANAGEMENT NO	Deletes all files on the built-in memory. The folder and file numbers are also reset.

Caution :

- All data on the built-in memory will be deleted when it is formatted.
Copy all files on the built-in memory to a computer before formatting.
- Make sure this unit is fully charged before formatting as the process may take some time. Alternatively, connect the AC adapter.

FORMAT SD CARD

Deletes all files on the SD card.

Setting	Details
FILE	AVCHD video files: Deletes all files on the SD card. The file numbers are also reset. Other files: Deletes all files on the SD card. The folder and file numbers won't be reset. (The folder and file numbers of newly recorded files will continue from the last number of the deleted files.)
FILE + MANAGEMENT NO	Deletes all files on the SD card. The folder and file numbers are also reset.

Memo :

- In case of AVCHD video file, there is no difference in the formatting result between "FILE" and "FILE + MANAGEMENT NO".

Caution :

- Not available for selection when no SD card is inserted.
- All data on the SD card will be deleted when it is formatted.
Copy all files on the SD card to a computer before formatting.
- Make sure this unit is fully charged before formatting as the process may take some time. Alternatively, connect the AC adapter.

USB CONNECTION MENU

This menu appears when this unit is connected to a computer using an USB cable.

PLAYBACK ON PC

- Displays videos recorded by this unit by using the Everio MediaBrowser 4.
“Installing the Provided Software (Built-in)” (☞ p. 95)
 - Saves videos recorded by this unit on your computer without using the provided software.
“Backing Up Files Without Using Provided Software” (☞ p. 101)
 - “Copying to Mac Computer” (☞ p. 103)
-

BACK UP

Backup videos recorded by this unit to your computer using the Everio MediaBrowser 4.

“Backing Up All Files” (☞ p. 97)

Memo :

- Before making backup, load the SD card in which the videos are stored on this unit.
- After backing up your files using the provided software, they cannot be restored to this unit.
- Delete unwanted videos before making backup.
It takes time to back up many videos.

“Deleting Unwanted Files” (☞ p. 61)

Right Side

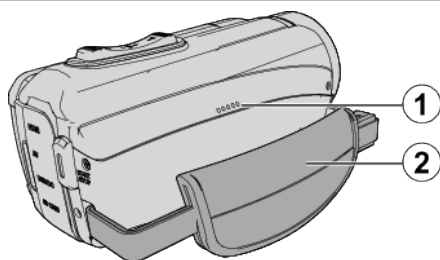

① Speaker

② Grip Belt

- Pass your hand through the grip belt to hold this unit firmly.

“Grip Adjustment” (☞ p. 9)

Bottom Side

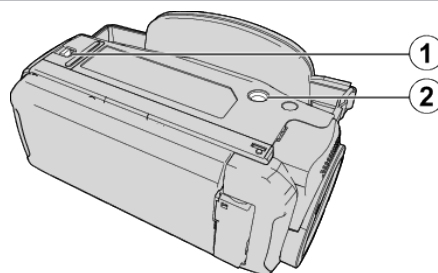

① Terminal Cover Lock

② Tripod Mounting Hole

“Tripod Mounting” (☞ p. 19)

Top/Left/Rear Side

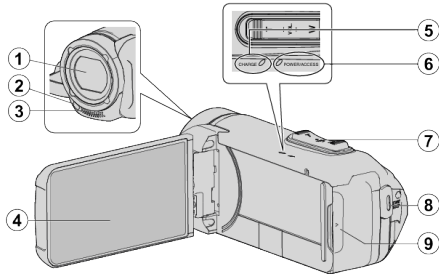

- 1 Lens**
 - The lens is protected by a protective glass cover.
 - If the lens is dirty, use a commercially available lens blower to remove any dust, and a commercially available cleaning cloth to wipe off any dirt.
 - Do not cover the front of the lens with your fingers during recording.
- 2 Light (GZ-RX115)**
 - Turn on the light when shooting in dark places.
- 3 Stereo Microphone**
 - Do not cover the microphone with your fingers during video recording.
- 4 LCD Monitor**
- 5 CHARGE (Charging) Lamp**
 - Lights up: Charging in progress
 - Goes off: Charging completed/Beyond temperature range
 - Blinks: Charging error or abnormal temperature
- 6 POWER/ACCESS (Power/Access) Lamp**
 - Lights up/blinks during recording or playback.
 - Do not remove the SD card or any connecting cables.
- 7 Zoom/Volume Lever**
 - During shooting: Adjusts the shooting range.
 - During playback (index screen): Moves to the next or previous page.
 - During video playback: Adjusts the volume.
- 8 START/STOP (Video Recording) Button**
 - Starts/stops recording of videos/still images.
- 9 Terminal Cover**

Inside Terminal Cover

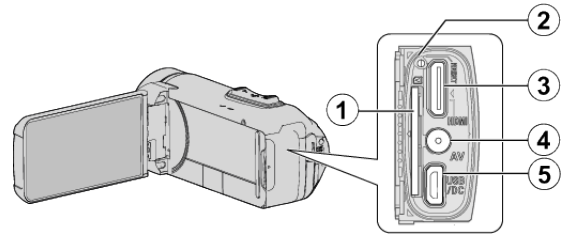

- 1 SD Card Slot**
 - Insert an optional SD card.
- 2 Reset Button**
- 3 HDMI mini connector**
 - Connects to TV using an HDMI mini cable.
- 4 AV Connector**
 - Connects to the AV connector of a TV, etc.
- 5 USB Connector (Micro USB AB type)**
 - Connect to the AC adapter to perform charging.
 - You can also connect to the external device or computer using the USB cable.

LCD Monitor

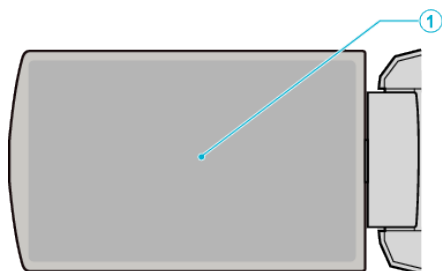

1 LCD Monitor

- Turns the power on/off by opening and closing.
- Enables self-portraits to be taken by rotating the monitor.

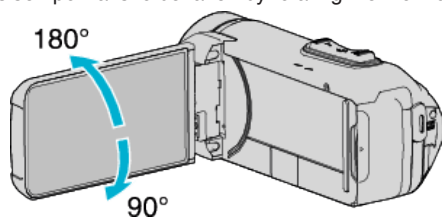

“Using the Touch Screen” (☞ p. 12)

“Names of Buttons and Functions on the LCD Monitor” (☞ p. 13)

Caution :

- Do not press against the surface with force or subject it to strong impact. Doing so may damage or break the screen.

Common Recording Indications

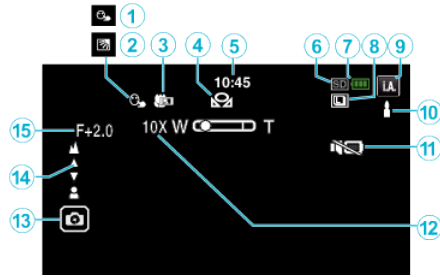

1 TOUCH PRIORITY AE/AF

“Capturing Subjects Clearly (TOUCH PRIORITY AE/AF)” (☞ p. 42)

2 Backlight Compensation

“Setting Backlight Compensation” (☞ p. 31)

3 Tele Macro

“Taking Close-up Shots (TELE MACRO)” (☞ p. 33)

4 WHITE BALANCE

“Setting White Balance” (☞ p. 32)

5 Time

“Clock Setting” (☞ p. 16)

6 Recording media

“REC MEDIA FOR VIDEO” (☞ p. 165)

“REC MEDIA FOR IMAGE” (☞ p. 165)

7 Battery Indicator

“Checking the Remaining Recording Time” (☞ p. 47)

8 CONTINUOUS SHOOTING

“SHUTTER MODE (Video)” (☞ p. 151)

“SHUTTER MODE (Still Image)” (☞ p. 156)

9 Recording Mode

“Taking Videos in Auto Mode” (☞ p. 22)

“Manual Recording” (☞ p. 28)

10 Setting Scenes of Intelligent Auto

- Displays scenes detected automatically in the Intelligent Auto function. Multiple scenes may be detected.

“Scenes of Intelligent Auto” (☞ p. 23)

11 SILENT MODE

“Using the Silent Mode” (☞ p. 24)

12 Zoom

“ZOOM” (☞ p. 152)

13 Shutter

“Capturing Still Images During Video Recording” (☞ p. 24)

“Taking Still Images in Auto Mode” (☞ p. 25)

14 Focus

“Adjusting Focus Manually (FOCUS)” (☞ p. 29)

15 Brightness

“Adjusting Brightness” (☞ p. 30)

Video Recording

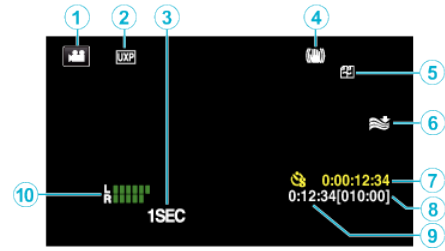

1 Video Mode

- Switches between video and still image modes.

2 Video Quality

“VIDEO QUALITY” (☞ p. 152)

3 TIME-LAPSE RECORDING(1SEC)

“Recording at Intervals (TIME-LAPSE RECORDING)” (☞ p. 44)

4 Image Stabilizer

“Reducing Camera Shake” (☞ p. 43)

5 Seamless Recording

“SEAMLESS RECORDING” (☞ p. 151)

6 Wind Cut

“WIND CUT” (☞ p. 151)

7 Time-Lapse Recording Counter

“Recording at Intervals (TIME-LAPSE RECORDING)” (☞ p. 44)

8 Remaining Recording Time

“Checking the Remaining Recording Time” (☞ p. 47)

9 Scene Counter

10 MIC LEVEL METER

“MIC LEVEL” (☞ p. 153)

Still Image Recording

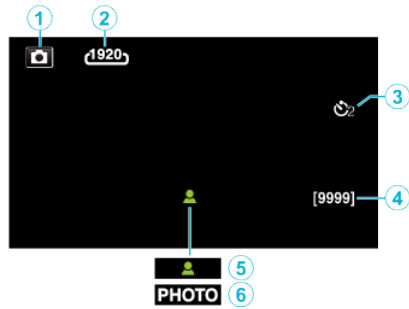

1 Still Image Mode

- Switches between video and still image modes.

2 Image Size

“IMAGE SIZE” (p. 156)

3 Self-Timer

“Taking Group Shots (Self-timer)” (p. 45)

4 Remaining Number of Shots

“Checking the Remaining Recording Time” (p. 48)

5 Focus

6 Recording in Progress

Video Playback



1 Video Mode

- Switches between video and still image modes.

2 Video Quality

“VIDEO QUALITY” (p. 152)

3 Operation Indicator

“Operation Buttons for Video Playback” (p. 50)

4 Date/Time

- Displays the recording date and time.

5 Recording media

6 Battery Indicator

“Checking the Remaining Recording Time” (p. 47)

7 Playback Time

8 Time-Lapse Playback

“Time-Lapse Setting” (p. 45)

9 External Storage Playback

“Playing Back with a DVD Writer” (p. 83)

“Playing Back with a BD Writer (External Blu-ray Drive)” (p. 75)

“Playing Back Files in the USB External Hard Disk Drive” (p. 88)

10 1080p Output

“HDMI OUTPUT” (p. 164)

11 SILENT MODE

“Using the Silent Mode” (p. 24)

12 Scene Counter

Still Image Playback



1 Still Image Mode

- Switches between video and still image modes.

2 Folder Number

3 File Number

4 Date/Time

- Displays the recording date and time.

5 Recording media

6 Battery Indicator

“Checking the Remaining Recording Time” (☞ p. 47)

7 SILENT MODE

“Using the Silent Mode” (☞ p. 24)

8 External Storage Playback

“Playing Back with a DVD Writer” (☞ p. 83)

“Playing Back with a BD Writer (External Blu-ray Drive)” (☞ p. 75)

“Playing Back Files in the USB External Hard Disk Drive” (☞ p. 88)

9 1080p Output

“HDMI OUTPUT” (☞ p. 164)

When the unit is not working properly

Resetting this Unit

- 1** Open the terminal cover.
 - Remove the power cord and all connecting cables.
- 2** Close the LCD monitor to turn off this unit.
- 3** Press the Reset button gently using an object with pointed tip.

Battery Pack

Unable to charge the battery.

When the battery pack is fully charged, the lamp does not light up. Be sure to charge using the supplied AC adapter. Malfunction in the unit that occurred due to the use of an AC adapter other than the one provided is not included in the warranty.

Check the connection, then disconnect and reconnect the charging adapter cable.

Charging cannot be performed under low or high temperature environments. Charge under the room temperature range of 10°C to 35°C. (Under environments beyond the temperature range, charging may stop to protect the battery pack.)

Using a non-original AC adapter may result in damage to this unit. Be sure to use an original AC adapter.

Charging is not possible when the video recording mode with progressive (50p) recording or Wi-Fi function is in used.

The remaining battery display is not correct.

If this unit is used for long periods of time in high or low temperatures, or if the battery pack is repeatedly charged, the amount of remaining battery may not be displayed correctly.

The battery runs out quickly even after charging.

Be sure to charge using the supplied AC adapter. Malfunction in the unit that occurred due to the use of an AC adapter other than the one provided is not included in the warranty.

The performance of the battery will drop temporarily when the temperature is -10°C to 0°C, this will cause the remaining recording time to shorten.

When the recording time becomes extremely short even when the battery is fully charged, the battery needs to be replaced. For details on replacing the built-in battery (subject to a fee), consult the nearest JVC service center.

Power supply

Unable to turn on the power.

The camera does not turn on if the remaining battery power is low. In this case, charge the battery for more than 20 minutes before turning on the power.

Recording

Recording cannot be performed.

Check the  /  button.

“Top/Left/Rear Side” (☞ p. 168)

Set to the recording mode by tapping the  button on the screen.

Recording stops automatically.

Recording stops automatically as it cannot be performed for 12 or more consecutive hours according to specifications. (It may take some time to resume recording.)

Turn off this unit, wait for a while, and turn it on again. (This unit stops automatically to protect the circuit when the temperature rises.)

The continuous shooting speed of still images is slow.

The continuous shooting speed will drop if this function is used repeatedly. Continuous shooting speed may drop depending on the SD card or under certain recording conditions.

The focus is not adjusted automatically.

If you are recording in a dark place or a subject that has no contrast between dark and light, adjust the focus manually.

“Adjusting Focus Manually (FOCUS)” (☞ p. 29)

Wipe the lens with a lens cleaning cloth.

Cancel manual focus on the manual recording menu.

“Adjusting Focus Manually (FOCUS)” (☞ p. 29)

Zoom does not work.

Digital zoom is not available in the still image recording mode.

Zoom operation is not available in time-lapse recording. (Simultaneous still image recording and image stabilizer are also not available.)

To use digital zoom, set “ZOOM” in the menu accordingly.

“ZOOM” (☞ p. 152)

Mosaic-type noise occurs when recording scenes with fast movements or extreme changes in brightness.

Set the “VIDEO QUALITY” to “UXP” or “XP” for recording.

“VIDEO QUALITY” (☞ p. 152)

SD Card

Cannot insert the SD card.

Make sure not to insert the SD card in the wrong direction.

“Inserting an SD Card” (☞ p. 10)

Do not use a miniSD card or microSD card on this unit (even if the card is inserted in an adapter). It may cause malfunction.

“Types of Usable SD Card” (☞ p. 11)

Unable to copy to SD card.

Set “REC MEDIA FOR VIDEO”/“REC MEDIA FOR IMAGE” to SD card.

“REC MEDIA FOR VIDEO” (☞ p. 165)

“REC MEDIA FOR IMAGE” (☞ p. 165)

To use a new SD card, or SD card used on other devices, it is necessary to format (initialize) the SD card using “FORMAT SD CARD” from the “MEDIA SETTINGS” menu.

“FORMAT SD CARD” (☞ p. 165)

When “CHECK CARD’S WRITE PROTECTION SWITCH” appears, release the lock on the SD card.

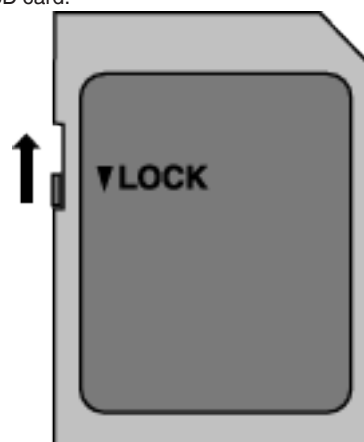

Playback

Sound or video is interrupted.

Sometimes playback is interrupted at the connecting section between two scenes. This is not a malfunction.

There is no sound.

When the Silent mode is used, operation sounds will not be output. Turn off the Silent mode.

“Using the Silent Mode” (☞ p. 24)

Set “OPERATION SOUND” in the “SETUP” menu to “ON”.

“OPERATION SOUND” (☞ p. 163)

Audio sound is not recorded for videos taken in TIME-LAPSE RECORDING.

“Recording at Intervals (TIME-LAPSE RECORDING)” (☞ p. 44)

The same image is displayed for a long time.

Use a high speed SD card (Class 4 or higher).

“Types of Usable SD Card” (☞ p. 11)

Clean the terminals of the SD card with a dry cotton swab or something similar.

Execute “FORMAT SD CARD” in the “MEDIA SETTINGS” menu. (All data will be deleted.)

“FORMAT SD CARD” (☞ p. 165)

The motion is choppy.

Use a high speed SD card (Class 4 or higher).

“Types of Usable SD Card” (☞ p. 11)

Clean the terminals of the SD card with a dry cotton swab or something similar.

Execute “FORMAT SD CARD” in the “MEDIA SETTINGS” menu. (All data will be deleted.)

“FORMAT SD CARD” (☞ p. 165)

Verify the system requirements of your PC when using Everio MediaBrowser 4 to play back.

“Verifying System Requirements (Guideline)” (☞ p. 92)

Cannot find a recorded file.

Change the playback media by tapping  on the touch screen.

“Operation Buttons for Video Playback” (☞ p. 50)

“Operation Buttons for Still Image Playback” (☞ p. 56)

Select “PLAYBACK OTHER FILE” in the menu. (Video files that have damaged management information can be played back.)

“PLAYBACK OTHER FILE” (☞ p. 55)

Images do not appear on the TV properly.

Disconnect the cable and connect again.

“Connecting via the HDMI Mini Connector” (☞ p. 58)

Reset this unit.

“Resetting this Unit” (☞ p. 173)

Images are projected vertically on the TV.

Set “VIDEO OUTPUT” in the “MEDIA SETTINGS” menu to “4:3”.

“VIDEO OUTPUT” (☞ p. 164)

Adjust the TV's screen accordingly.

The image displayed on TV is too small.

Set “VIDEO OUTPUT” in the “MEDIA SETTINGS” menu to “16:9”.

“VIDEO OUTPUT” (☞ p. 164)

When connected to the TV via the HDMI mini cable, proper images and sounds are not output.

Images and sounds may not be output properly depending on the TV connected. In such cases, perform the following operations.

1 Disconnect the HDMI mini cable and connect it again.

“Connecting via the HDMI Mini Connector” (☞ p. 58)

Editing/Copying

Unable to delete file.

Files (videos/still images) that are protected cannot be deleted. Release protection before deleting the file.

“Protecting Files” (☞ p. 62)

Unable to copy to SD card.

If the SD card is write protected, set it to off.

Unable to create DVD with a DVD writer.

Connect the USB cable correctly.

“Preparing a DVD Writer (CU-VD3)” (☞ p. 76)

“Preparing a DVD Writer (CU-VD50)” (☞ p. 77)

Unable to create disc with a BD writer (external Blu-ray drive).

Connect the USB cable correctly.

“Preparing a BD Writer (External Blu-ray Drive)” (☞ p. 68)

BACK-UP menu does not disappear.

While the USB cable is connected, the “BACK UP” menu is displayed.

Unable to turn off the BACK-UP menu.

Turn off the power of this unit and the DVD writer, or remove the USB cable.

Unable to delete folder in USB external hard disk drive.

Delete the folder using a computer.

(When files are added or folders moved/renamed with a computer, they cannot be deleted on this unit.)

Computer

Unable to copy files to the computer's HDD.

If the provided software Everio MediaBrowser 4 is not installed, some functions may not work properly.

"Installing the Provided Software (Built-in)" (☞ p. 95)

Before making backup, make sure that enough free space is left in the computer's hard disk (HDD).

Unable to copy files to DVD or Blu-ray disc with a PC.

To record to discs, a recordable DVD or Blu-ray drive is required for the computer in use.

Cannot upload the file to YouTube.

Check if you have created an account with YouTube. (You need a YouTube account to upload files to YouTube.)

Changing videos to the file format for uploading cannot be performed on this unit.

Refer to the help file of the provided software Everio MediaBrowser 4

I am using a Mac computer.

Load the files to a Mac computer using the following method.

"Copying to Mac Computer" (☞ p. 103)

The computer cannot recognize the SDXC card.

Confirm and update the OS of your computer.

"When your computer cannot recognize the SDXC card" (☞ p. 11)

Screen/Image

The LCD monitor is difficult to see.

The LCD monitor may be difficult to see if used in bright areas such as under direct sunlight.

Color and brightness of the screen changes and horizontal stripes and flickers appear on screen

For images recorded under lighting from fluorescent or mercury lamps, the color and brightness of the screen may change and horizontal stripes and flickers may appear on the screen, but this is not a malfunction.

If the image stabilizer has been set to "ON (AIS)", switch to "ON" to improve the condition.

"Reducing Camera Shake" (☞ p. 43)

A band or a ball of bright light appears on the LCD monitor.

Change the direction of this unit to prevent the light source from coming into view. (A band or a ball of bright light may appear when there is a bright light source near this unit, but this is not a malfunction.)

The recorded subject is too dark.

Use backlight compensation when the background is bright and the subject is dark.

"Setting Backlight Compensation" (☞ p. 31)

Use "GAIN UP" in the menu.

"GAIN UP" (☞ p. 151)

Set "BRIGHTNESS ADJUST" in the recording menu to the "+" side.

"Adjusting Brightness" (☞ p. 30)

The recorded subject is too bright.

Set the backlight compensation to "OFF" if it is being used.

"Setting Backlight Compensation" (☞ p. 31)

Set "BRIGHTNESS ADJUST" in the recording menu to the "-" side.

"Adjusting Brightness" (☞ p. 30)

The color looks strange. (Too bluish, too reddish, etc.)

Wait for a while until natural colors are achieved. (It may take some time for white balance to be adjusted.)

Set "WHITE BALANCE" in the recording menu to "MANUAL". Select from "FINE"/"CLOUD"/"HALOGEN" according to the light source. Select "MWB" and adjust accordingly.

"Setting White Balance" (☞ p. 32)

The color looks different.

Set "WHITE BALANCE" in the recording menu accordingly.

"Setting White Balance" (☞ p. 32)

There are bright or dark spots on the screen.

While the LCD monitor screen has more than 99.99% effective pixels, 0.01% of the pixels may be bright spots (red, blue, green) or dark spots. This is not a malfunction. The spots will not be recorded.

Other Problems

The buttons on the touch screen do not work.

Tap the buttons on the touch screen with your fingers. The buttons may not respond if you touch them with your fingernails or with gloves on.

Disable "SCREEN LOCK". You cannot operate the touch panel when "SCREEN LOCK" is enabled.

"Locking the Screen" (☞ p. 35)

Save the recorded data before requesting service.

- 1 Connect to computer using a USB cable.
The "SELECT DEVICE" menu appears.
- 2 Press and hold the START/STOP button for more than 2 seconds.
The "PLAYBACK ON PC" appears.
- 3 Operations are to be performed on the computer after the screen switches.

The image is grainy.

When digital zoom is used, the image becomes grainy as it is digitally enlarged.

This unit heats up.

This is not a malfunction. (This unit may become warm when used for a long time.) Stop using the unit if it gets too warm.

The language on the display changed.

It may occur when you connect this unit to a TV with different language setting using an HDMI mini cable.

"Operating in Conjunction with TV via HDMI" (☞ p. 59)

When connected to the TV via the HDMI mini cable, proper images and sounds are not output.

Images and sounds may not be output properly depending on the TV connected. In such cases, perform the following operations.

- 1 Disconnect the HDMI mini cable and connect it again.
- 2 Turn off and on this unit again.

"Connecting via the HDMI Mini Connector" (☞ p. 58)

HDMI-CEC functions do not work properly, and the TV does not work in conjunction with this unit.

TVs may operate differently depending on the specifications, even if they are HDMI-CEC compliant. Therefore, the HDMI-CEC functions of this unit cannot be guaranteed to operate in combination with all the TVs. In such cases, set "HDMI CONTROL" to "OFF".

"HDMI CONTROL" (☞ p. 164)

The unit operates slowly when switching between video mode and still image mode, or when switching the power on or off.

It is recommended that you copy all videos and still images onto your computer, and erase the files from this unit. (If there are many recorded files on this unit, it takes time for the unit to respond.)

This unit does not function properly and error messages appear.

This unit is a microcomputer-controlled device. Electrostatic discharge, external noise and interference (from a TV, a radio, etc.) might prevent it from functioning properly. In such a case, close the monitor screen to turn off the power and remove the AC adapter, then press the Reset button to reset this unit.

"Resetting this Unit" (☞ p. 7)

CHARGE lamp and POWER/ACCESS lamp are blinking and operation is disabled

After closing the LCD monitor, remove the AC adapter. Reattach the AC adapter, and turn on the power by opening the LCD monitor. If these operations won't solve the problem, contact your JVC dealer or the JVC service center.

Disclaimer

- We shall not be held responsible for loss of recorded contents when recording videos/audio or playback cannot be operated due to malfunctions in this unit, provided parts, or SD card.

- Once deleted, recorded contents (data), including data loss due to malfunctions in this unit, cannot be restored. Please be forewarned.

- JVC will not be responsible for any lost data. Please be forewarned.

- In order for quality improvement, defective recording medium is subject to be analyzed. Therefore, it may not be returned.

Error Message?

SET DATE/TIME!

The clock is reset about one month after the battery is depleted. Therefore, "SET DATE/TIME!" will appear the next time the power is turned on. Set the clock again after charging the battery.
"Clock Setting" (☞ p. 16)

COMMUNICATION ERROR

Reconnect the USB cable.
Turn off and on the devices connected to this unit, and reset this unit.
"Resetting this Unit" (☞ p. 173)

FORMAT ERROR!

Reset this unit.
"Resetting this Unit" (☞ p. 173)

ERROR IN BUILT-IN MEMORY!

Reset this unit.
"Resetting this Unit" (☞ p. 173)
If the above does not solve the problem, back up your files and execute "FORMAT BUILT-IN MEM." in the "MEDIA SETTINGS" menu. (All data will be deleted.)
"FORMAT BUILT-IN MEM." (☞ p. 165)

MEMORY CARD ERROR!

Check that the card is supported by this unit.
"Types of Usable SD Card" (☞ p. 11)
Reset this unit.
"Resetting this Unit" (☞ p. 173)
Turn off this unit, then remove and re-insert the SD card.
Remove any dirt from the SD card terminals.
If the above does not solve the problem, back up your files and execute "FORMAT SD CARD" in the "MEDIA SETTINGS" menu. (All data will be deleted.)
"FORMAT SD CARD" (☞ p. 165)

NOT FORMATTED

Select "OK", then select "YES" on the "DO YOU WANT TO FORMAT?" screen.

RECORDING FAILURE

Reset this unit.
"Resetting this Unit" (☞ p. 173)

CANNOT TAKE MORE STILL IMAGES AT THIS TIME

Stop video recording before taking still images. (If the SD card is removed and inserted during video recording, still images cannot be recorded.)

PLAYBACK FAILED

Remove and re-insert the SD card.
"Inserting an SD Card" (☞ p. 10)
Remove any dirt from the SD card terminals.
Insert the SD card before turning on the power.
Do not subject this unit to any strong impact or vibration.

VIDEO MANAGEMENT FILE IS DAMAGED, RECOVERY IS REQUIRED TO RECORD/PLAYBACK, RECOVER?

Select "OK" to restore. (Videos that cannot be restored will not be displayed on the index screen, but you may be able to play them back using "PLAYBACK OTHER FILE" in the menu.)
"PLAYBACK OTHER FILE" (☞ p. 55)

UNSUPPORTED SCENE!

Use files recorded with this unit. (Files recorded with other devices may not be playable.)

UNSUPPORTED FILE!

Use files recorded with this unit. (Files recorded with other devices may not be playable.)

THIS FILE IS PROTECTED

Switch off the "PROTECT/CANCEL" function in the "EDIT" menu.
"Protecting Files" (☞ p. 62)

CHECK CARD'S WRITE PROTECTION SWITCH

Set the write protect switch of the SD card to off.

INSUFFICIENT AVAILABLE SPACE

Delete files, or move files to a computer or other devices.
Replace the SD card with a new one.
Seamless videos cannot be combined if there is not enough free space in the built-in memory or SD card. Check the amount of remaining free space before combining.

RECORDABLE MANAGEMENT CAPACITY LEVEL HAS BEEN REACHED

- 1 Move the files or folders to a computer or other device. (Back up your files.)
- 2 Select "FILE + MANAGEMENT NO" in "FORMAT BUILT-IN MEM." or "FORMAT SD CARD" of the "MEDIA SETTINGS" menu. (All data on the built-in memory or SD card will be deleted.)
"FORMAT BUILT-IN MEM." (☞ p. 165)
"FORMAT SD CARD" (☞ p. 165)

SCENE QUANTITY EXCEEDED LIMIT

- 1 Move the files or folders to a computer or other device. (Back up your files.)
- 2 Select "FILE + MANAGEMENT NO" in "FORMAT BUILT-IN MEM." or "FORMAT SD CARD" of the "MEDIA SETTINGS" menu. (All data on the built-in memory or SD card will be deleted.)
"FORMAT BUILT-IN MEM." (☞ p. 165)
"FORMAT SD CARD" (☞ p. 165)

NUMBER OF FOLDERS OVERFLOW

- 1 Move the files or folders to a computer or other device. (Back up your files.)
- 2 Select "FILE + MANAGEMENT NO" in "FORMAT BUILT-IN MEM." or "FORMAT SD CARD" of the "MEDIA SETTINGS" menu. (All data on the built-in memory or SD card will be deleted.)
"FORMAT BUILT-IN MEM." (☞ p. 165)
"FORMAT SD CARD" (☞ p. 165)

FILE QUANTITY LIMIT EXCEEDED

- 1 Move the files or folders to a computer or other device. (Back up your files.)
- 2 Select "FILE + MANAGEMENT NO" in "FORMAT BUILT-IN MEM." or "FORMAT SD CARD" of the "MEDIA SETTINGS" menu. (All data on the built-in memory or SD card will be deleted.)
"FORMAT BUILT-IN MEM." (☞ p. 165)
"FORMAT SD CARD" (☞ p. 165)

PLAYLIST QUANTITY EXCEEDS LIMIT

Reduce the number of the playlist to 99 files or less. (Up to 99 playlists can be created.)

PROCESSING CANCELLED DUE TO LIMITED SPACE FOR OPERATION

The number of videos that can be recorded on a disc has exceeded. Make sure the number of videos recorded in 50i mode ("SYSTEM SELECT" set to "50i") does not exceed 999, and the videos recorded in 50p mode ("SYSTEM SELECT" set to "50p") does not exceed 200.

NO FILES

Change the setting of “REC MEDIA FOR IMAGE” or “REC MEDIA FOR VIDEO” in the “MEDIA SETTINGS” menu, and check that files are not recorded to the other media.

“REC MEDIA FOR VIDEO” (p. 165)

“REC MEDIA FOR IMAGE” (p. 165)

RECORDING CANCELLED

Reset this unit.

“Resetting this Unit” (p. 173)

Protect the unit from vibration and shock.

CAMERA TEMPERATURE IS HIGH PLEASE TURN CAMERA OFF TO ALLOW IT TO COOL DOWN PLEASE WAIT

Turn off the power of this unit, let and it cool down before turning on the power again.

POWER IS OFF, OR USB DEVICE IS UNSUPPORTED

Turn on the power of the connected USB device.

Connect the AC adapter to the DVD writer or BD writer (external Blu-ray drive).

INSERT DISC

Open the tray of the DVD writer or BD writer (external Blu-ray drive), check and reset the DVD or Blu-ray disc, then close the tray.

Replace the disc in the DVD writer or BD writer (external Blu-ray drive).

CHANGE DISC

Open the tray of the DVD writer or BD writer (external Blu-ray drive), check and reset the DVD or Blu-ray disc, then close the tray.

Replace the disc in the DVD writer or BD writer (external Blu-ray drive).

Perform regular maintenance of this unit to enable it to be used for a long time.

Caution :

- Be sure to detach the AC adapter and power plug before performing any maintenance.

Camcorder

- Wipe this unit with a dry, soft cloth to remove any dirt.
- When it is extremely dirty, soak the cloth in a solution of neutral detergent, wipe the body with it, and then use a clean cloth to remove the detergent.

Caution :

- Do not use solvents such as benzene, thinner, or alcohol. Doing so may cause damage to the unit.
- When using a chemical cloth or cleaner, be sure to observe the warning labels and instructions of the product.
- Do not leave the device in contact with rubber or plastic products for a long time.

Lens/LCD Monitor

- Use a lens blower (commercially available) to remove any dust, and a cleaning cloth (commercially available) to wipe off any dirt.
Mold may form if the lens is left dirty.
- You can use a commercially available anti-reflection or protective film on the screen.
However, depending on the thickness of the film, operations on the touch screen may not be performed smoothly or the screen may darken slightly.

After using underwater or on the beach

- For care and cleaning where there is mud or dirt on the camera after using underwater or on the beach, read "Before Using Underwater or under Low Temperature" (p. 8) .

Camera

Item	Details
Power supply	Using AC adapter: DC 5.2 V
Power consumption	2.3 W (50i mode, "LIGHT": "OFF", MONITOR BRIGHTNESS: 3 (standard)) 2.5 W (50i mode, "LIGHT": "OFF", MONITOR BRIGHTNESS: 4 (brighter)) Rated Current Consumption: 1A
Dimensions (mm)	60 x 59.5 x 122 (W x H x D: excluding grip belt)
Mass	Approx. 290 g (camera only)
Operating environment	Allowable operating temperature: -10 °C to 40 °C Allowable storage temperature: -20 °C to 50 °C Allowable charging temperature: 10 °C to 35 °C Allowable relative humidity: 35 % to 80 %
Image pickup device	1/5.8" 2,510,000 pixels (CMOS, back-illuminated)
Recording area (Video)	1,280,000 to 2,290,000 pixels (image stabilizer: off)
Recording area (Still image)	2,290,000 pixels (16:9) 1,710,000 pixels (4:3)
Lens	F1.8 to F6.3 f= 2.9 mm to 116.0 mm 35 mm conversion: Video 40.5 mm to 1620 mm (image stabilizer: off) Still Image 40.5 mm to 1620 mm (16:9) 49.5 mm to 1980 mm (4:3)
Lowest illumination	3 lux
Zoom (during video recording)	Optical zoom: Up to 40x Dynamic zoom: Up to 60x Digital zoom: Up to 200x
Zoom (during still image recording)	Optical zoom: Up to 40x
LCD monitor	3.0", 230,000 pixels, color LCD
Recording media	Built-in memory (8 GB: GZ-RX110, 16 GB: GZ-RX120) SD/SDHC/SDXC card (commercially available) "Types of Usable SD Card" (see p. 11)

Connectors

Item	Details
HDMI output connector	HDMI mini connector
AV output connector	Video output: 1.0 V (p-p), 75 Ω Audio output: 300 mV (rms), 1 KΩ
USB connector	Micro USB Type AB, USB 2.0 compliant

Video

Item	Details
Recording/ Playback format	AVCHD standard Video: MPEG-4 AVC/H.264 Audio: Dolby Digital 2ch
Extension	.MTS
Signal system	PAL standard
Video Quality (Recording pixel count/Average recording bit rate)	UXP 1920 pixels x 1080 pixels Average Approximate 24 Mbps XP 1920 pixels x 1080 pixels Average Approximate 17 Mbps EP 1920 pixels x 1080 pixels Average Approximate 4.8 Mbps 50p 1920 pixels x 1080 pixels Average Approximate 27 Mbps
Sound quality (Audio)	48 kHz, 256 kbps

Still Image

Item	Details
Recording format	JPEG standard
Extension	.JPG
Image Size (Recording pixel count)	(16:9 aspect ratio) 1920 pixels x 1080 pixels (2M) (4:3 aspect ratio) 3680 pixels x 2760 pixels (10.15M) 1440 pixels x 1080 pixels (1.5M) 640 pixels x 480 pixels (0.3M) “Approximate Number of Still Images (Unit: Number of Shots)” (p. 48)

AC Adapter (AC-V10M)

Item	Details
Power supply	AC 110 V to 240 V, 50 Hz/60 Hz
Output	DC 5.2 V, 1 A
Allowable operating temperature	0°C to 40°C (10°C to 35°C during charging)
Dimensions (mm)	83 x 28 x 40 (W x H x D: excluding cord and AC plug)
Mass	Approx. 77 g

Memo :

- The specifications and appearance of this product are subject to changes for further improvement without prior notice.

Trademarks

- AVCHD and AVCHD logo are trademarks of Panasonic Corporation and Sony Corporation.
- HDMI (High-Definition Multimedia Interface) and HDMI logo are either registered trademarks or trademarks of HDMI Licensing, LLC in the United States and/or other countries.



- Manufactured under license from Dolby Laboratories. Dolby and the double-D symbol are trademarks of Dolby Laboratories.
- SDXC logo is a trademark of SD-3C, LLC.
- Windows® and Windows Vista® are either registered trademarks or trademarks of Microsoft Corporation in the United States and/or other countries.
- iMovie, iPhone and iPhoto are trademarks of Apple Inc., registered in the U.S. and other countries.
- Intel and Intel Core are trademarks or registered trademarks of Intel Corporation in the United States.
- Android is a trademark or registered trademark of Google Inc.
- QR Code is a registered trademark of Denso Wave Incorporated.
- Wi-Fi, Wi-Fi logo, Wi-Fi CERTIFIED, Wi-Fi CERTIFIED logo, Wi-Fi Protected Setup, Wi-Fi Protected Setup logo, WPA, and WPA2 are trademarks or registered trademarks of Wi-Fi Alliance.
- Other product and company names included in this instruction manual are trademarks and/or registered trademarks of their respective holders.
- Marks such as ™ and ® have been omitted in this manual.

JVC