

# JVC

## CAMCORDER

---

Detailed User Guide

**GZ-MS230** **AG/AS**

**GZ-MS215** **AG/AS/AA/AH**



Everio

## Contents

### Beginner's Guide ..... 4

|                     |   |
|---------------------|---|
| Charging .....      | 4 |
| Recording .....     | 4 |
| Playback .....      | 4 |
| Shooting Tips ..... | 4 |

### Useful Shooting Techniques

|                                |   |
|--------------------------------|---|
| Holiday Season/Christmas ..... | 5 |
| Wedding .....                  | 6 |
| Travel .....                   | 7 |
| Amusement Park .....           | 8 |

### Getting Started

|  |    |
|--|----|
| Verifying the Accessories .....                      | 10 |
| Attaching the Core Filter to the DC cord .....       | 11 |
| Charging the Battery Pack .....                      | 12 |
| Grip Adjustment .....                                | 13 |
| Hand Strap .....                                     | 13 |
| Inserting an SD Card (GZ-MS230) .....                | 13 |
| Types of Usable SD Card .....                        | 14 |
| Inserting an SD Card (GZ-MS215) .....                | 14 |
| Types of Usable SD Card .....                        | 15 |
| Clock Setting .....                                  | 15 |
| Resetting the Clock .....                            | 16 |
| Changing the Display Language .....                  | 16 |
| Using the Operation Buttons .....                    | 16 |
| Using the Slider .....                               | 16 |
| Grip Adjustment .....                                | 17 |
| Tripod Mounting .....                                | 17 |
| Using this Unit Overseas .....                       | 18 |
| Charging the Battery Pack Overseas .....             | 18 |
| Setting the Clock to Local Time when Traveling ..... | 18 |
| Setting Daylight Saving Time .....                   | 19 |
| Optional Accessories .....                           | 19 |

### Recording

|   |    |
|---|----|
| Taking Videos in Auto Mode .....                              | 20 |
| Zooming .....   | 21 |
| Capturing Still Images During Video Recording .....           | 21 |
| Reducing Camera Shake .....                                   | 22 |
| Checking the Captured Image Immediately .....                 | 22 |
| Taking Still Images in Auto Mode .....                        | 22 |
| Zooming .....   | 24 |
| Checking the Captured Image Immediately .....                 | 24 |
| Manual Recording .....  | 24 |
| Scene Selection .....   | 25 |
| Adjusting Focus Manually .....                                | 26 |
| Adjusting Brightness .....                                    | 27 |
| Setting Shutter Speed .....                                   | 27 |
| Setting White Balance .....                                   | 28 |
| Setting Backlight Compensation .....                          | 28 |
| Setting Metering Area .....                                   | 29 |
| Recording with Effects (GZ-MS230) .....                       | 29 |
| Taking Close-up Shots .....                                   | 30 |
| Registering Files to Events Before Recording .....            | 30 |
| Taking Videos in YouTube Format .....                         | 31 |
| Taking Videos in iTunes Format .....                          | 32 |
| Recording at Intervals (TIME-LAPSE RECORDING) .....           | 32 |
| Recording Automatically by Sensing Movements (AUTO REC) ..... | 34 |
| Remaining Recording Time/Battery Power .....                  | 35 |

### Playback

|  |    |
|--|----|
| Playing Back Videos .....                    | 37 |
| Checking the Content of Videos Quickly ..... | 38 |

|   |    |
|---|----|
| Playing a Video with Defective Management Information ..... | 38 |
| Playing Back Still Images .....                             | 39 |
| Slideshow Playback .....                                    | 39 |
| Searching for a Specific Video/Still Image .....            | 40 |
| Group Search .....  | 40 |
| Date Search .....   | 40 |
| Event and Date Search .....                                 | 41 |
| Connecting to and Viewing on TV .....                       | 41 |
| Playing Back Playlists .....                                | 42 |

### Editing

|  |    |
|--|----|
| Deleting Unwanted Files .....                              | 43 |
| Deleting the Currently Displayed File .....                | 43 |
| Deleting Selected Files .....                              | 44 |
| Deleting All Files .....                                   | 45 |
| Protecting Files .....                                     | 45 |
| Protecting the Currently Displayed File .....              | 45 |
| Protecting Selected Files .....                            | 46 |
| Protecting All Files .....                                 | 47 |
| Releasing Protection of All Files .....                    | 47 |
| Changing Event Registration of Videos .....                | 48 |
| Changing the Event of the Currently Displayed File .....   | 48 |
| Changing the Event of the Selected Files .....             | 49 |
| Capturing a Still Image in the Video during Playback ..... | 50 |
| Capturing a Required Part in the Video .....               | 50 |
| Capturing Videos for Uploading to YouTube .....            | 51 |
| Preparing Videos to Transfer to iTunes .....               | 52 |
| Creating Playlists from the Recorded Videos .....          | 53 |
| Creating Playlists with Selected Files .....               | 53 |
| Creating Playlists by Group .....                          | 54 |
| Creating Playlists by Date .....                           | 55 |
| Creating Playlists by Event .....                          | 56 |
| Editing Playlists .....                                    | 57 |
| Deleting Playlists .....                                   | 58 |

### Copying

|   |    |
|---|----|
| Copying Files to Card .....                     | 59 |
| Copying All Files .....                         | 59 |
| Copying Selected Files .....                    | 60 |
| Moving Files .....                              | 61 |
| Moving All Files .....                          | 61 |
| Moving Selected Files .....                     | 62 |
| Dubbing Files to a DVD Recorder or VCR .....    | 63 |
| Copying to Windows PC .....                     | 64 |
| Verifying System Requirements (Guideline) ..... | 64 |
| Installing the Provided Software .....          | 64 |
| Backing Up All Files .....                      | 65 |
| Organizing Files .....                          | 66 |
| Recording Videos to Discs .....                 | 67 |
| JVC Software Licence Agreement .....            | 68 |
| List of Files and Folders .....                 | 69 |
| Copying to Mac Computer .....                   | 70 |

### Menu Settings

|                                    |    |
|------------------------------------|----|
| Operating the Menu .....           | 71 |
| Recording Menu (Video) .....       | 72 |
| LIGHT .....                        | 73 |
| REGISTER EVENT .....               | 73 |
| VIDEO QUALITY .....                | 73 |
| ZOOM .....                         | 74 |
| GAIN UP .....                      | 74 |
| TIME-LAPSE RECORDING .....         | 74 |
| AUTO REC .....                     | 74 |
| AUTO SWITCH REC MEDIA .....        | 75 |
| SELECT ASPECT RATIO .....          | 75 |
| WIND CUT .....                     | 76 |
| Recording Menu (Still Image) ..... | 77 |
| LIGHT .....                        | 78 |
| SELF-TIMER .....                   | 78 |

|                                       |    |                             |            |
|---------------------------------------|----|-----------------------------|------------|
| SHUTTER MODE .....                    | 79 | Recording .....             | 105        |
| IMAGE QUALITY .....                   | 79 | Card .....                  | 105        |
| GAIN UP .....                         | 80 | Playback .....              | 105        |
| AUTO REC .....                        | 80 | Editing/Copying .....       | 106        |
| Manual Settings Menu .....            | 81 | PC .....                    | 106        |
| SCENE SELECT .....                    | 81 | Screen/Image .....          | 106        |
| FOCUS .....                           | 81 | Other Problems .....        | 106        |
| BRIGHTNESS ADJUST .....               | 81 | Error Message? .....        | 106        |
| SHUTTER SPEED .....                   | 81 |                             |            |
| WHITE BALANCE .....                   | 81 | <b>Maintenance .....</b>    | <b>108</b> |
| BACKLIGHT COMP. ....                  | 81 |                             |            |
| METERING AREA/TYPE .....              | 81 | <b>Specifications .....</b> | <b>109</b> |
| EFFECT (GZ-MS230) .....               | 81 |                             |            |
| TELE MACRO .....                      | 81 |                             |            |
| Playback Menu (Video) .....           | 82 |                             |            |
| DELETE .....                          | 83 |                             |            |
| SEARCH .....                          | 83 |                             |            |
| PLAYBACK PLAYLIST .....               | 83 |                             |            |
| EDIT PLAYLIST .....                   | 83 |                             |            |
| PLAYBACK MPG FILE .....               | 83 |                             |            |
| EDIT .....                            | 83 |                             |            |
| ON-SCREEN DISPLAY .....               | 84 |                             |            |
| Playback Menu (Still Image) .....     | 85 |                             |            |
| DELETE .....                          | 85 |                             |            |
| SEARCH DATE .....                     | 85 |                             |            |
| EDIT .....                            | 85 |                             |            |
| SLIDE SHOW EFFECTS .....              | 86 |                             |            |
| ON-SCREEN DISPLAY .....               | 87 |                             |            |
| Display Settings Menu .....           | 88 |                             |            |
| LANGUAGE .....                        | 88 |                             |            |
| DATE DISPLAY STYLE .....              | 88 |                             |            |
| MONITOR BRIGHTNESS .....              | 88 |                             |            |
| LCD BACKLIGHT .....                   | 89 |                             |            |
| CLOCK ADJUST .....                    | 89 |                             |            |
| Basic Settings Menu .....             | 90 |                             |            |
| DEMO MODE .....                       | 91 |                             |            |
| AUTO POWER OFF .....                  | 91 |                             |            |
| OPERATION SOUND .....                 | 92 |                             |            |
| RECORD BUTTON .....                   | 92 |                             |            |
| QUICK RESTART .....                   | 93 |                             |            |
| UPDATE .....                          | 93 |                             |            |
| FACTORY PRESET .....                  | 93 |                             |            |
| Connection Settings Menu .....        | 94 |                             |            |
| DISPLAY ON TV .....                   | 94 |                             |            |
| VIDEO OUTPUT .....                    | 94 |                             |            |
| Media Settings Menu .....             | 95 |                             |            |
| REC MEDIA FOR VIDEO (GZ-MS230) .....  | 95 |                             |            |
| VIDEO SLOT SELECTION (GZ-MS215) ..... | 95 |                             |            |
| REC MEDIA FOR IMAGE (GZ-MS230) .....  | 96 |                             |            |
| IMAGE SLOT SELECTION (GZ-MS215) ..... | 96 |                             |            |
| FORMAT BUILT-IN MEM. (GZ-MS230) ..... | 97 |                             |            |
| FORMAT SD CARD .....                  | 97 |                             |            |
| ERASE ALL DATA (GZ-MS230) .....       | 98 |                             |            |

---

## Names of Parts

|                   |     |
|-------------------|-----|
| Front .....       | 99  |
| Rear .....        | 99  |
| Bottom .....      | 100 |
| Interior .....    | 100 |
| LCD Monitor ..... | 101 |

---

## Indications on the LCD monitor

|                                    |     |
|------------------------------------|-----|
| Common Recording Indications ..... | 102 |
| Video Recording .....              | 102 |
| Still Image Recording .....        | 103 |
| Video Playback .....               | 103 |
| Still Image Playback .....         | 104 |

---

## Troubleshooting

|                    |     |
|--------------------|-----|
| Battery Pack ..... | 105 |
|--------------------|-----|

### Charging

- Refer to the operating instructions found in the animation on the Detailed User Guide.

### Recording

- Refer to the operating instructions found in the animation on the Detailed User Guide.

### Playback

- Refer to the operating instructions found in the animation on the Detailed User Guide.

### Shooting Tips

#### Basic Way to Hold a Camcorder ~ Recording Stable Images ~



This is the standard way of shooting while standing up. Be sure to master this basic technique in order to achieve stable images.

#### ■ [Getting Ready]

- ① Open your feet to the width of your shoulders.
- ② Keep the elbow of your right arm, which is holding the camcorder, close to your side.
- ③ Hold the LCD monitor with your left hand and adjust the angle accordingly.

#### Extending Your Hands to Shoot ~ High-Angle Shooting ~



Extend your hand when your subject is being hidden behind a crowd of people.

#### ■ [Getting Ready]

- ① Open your feet to the width of your shoulders.
- ② Extend your right hand and hold the camcorder over your head.
- ③ Hold the LCD monitor with your left hand and adjust the angle accordingly.

#### CAUTION:

- Use this way of shooting only as a last resort as it is difficult to achieve stable images.
- Set to the wide angle as much as possible as the image will be prone to camera shake.
- Be considerate. Do not inconvenience the people around you.

#### Squatting and Shooting at Eye Level



Staying low is a common position to take when shooting small children. By recording from the eye level of the child, you can capture all his cute expressions clearly.

#### ■ [Getting Ready]

- ① Kneel down with your left knee while keeping your right foot on the ground.
- ② Place the elbow of your right arm, which is holding the camcorder, on your right knee.
- ③ Hold the LCD monitor with your left hand and adjust the angle accordingly.

#### Panning

- Refer to the operating instructions found in the animation on the Detailed User Guide.

Use this method to shoot a wide angle of view.

#### ■ [Getting Ready]

Shoot by rotating your body instead of moving your arms while keeping the basic way of holding a camcorder as stated above.

- ① Stand facing the direction where the rotation will stop.
- ② Twist your upper body to the direction where recording will start.
- ③ Press the start button and record for 2 seconds, then slowly twist back your body to face the front.  
Record for another 2 seconds while facing the front, then press the stop button.  
(The 90 degrees rotation should take about 5 seconds, giving the feeling of a slow motion.)

## Holiday Season/Christmas

Record the happy Christmas celebration with your family!



Photo by 101st CAB, Wings of Destiny  
[Creative Commons Attribution-No Derivative Works 3.0](#)

### Decorating the Tree and Preparing the Dinner

The decoration of tree and preparation of dinner are part of the joy of Christmas. Be sure to record these happy family times!

#### ■ Decorating the tree



A tree is the most important thing to bring out the mood of Christmas. Simply the scene of all family members engaging in the decorating of a fir tree with various colorful ornaments is full of the feeling of happiness.

#### ■ Preparing the Dinner



Photo by Manicosity  
[Creative Commons Attribution-No Derivative Works 3.0](#)  
 Record the scenes as everyone helps to prepare the feast of the night. You can film the mother who is cooking, the children who are helping, and of course, the process of making a cake!

### Recording the Christmas Party



Photo by InnerSpirit  
[Creative Commons Attribution-No Derivative Works 3.0](#)

After all preparations, it is finally the Christmas party itself. Not only should you record the candle-blowing scene, but also the smiles of the family while being surrounded by good food, or even the father who is slightly drunk from champagne!

### Finding the Presents



For children, the greatest joy of Christmas is receiving presents the next morning. Their expression of delight when finding a present next to their pillow is a recording opportunity not to be missed. Get ready to shoot before the children wake up!

### Wedding

Create an awesome wedding video for the bride and groom!



#### Discussing and Planning Before the Event

Before the day of the wedding reception, it is important to discuss with the bride and groom about various details such as the order of the ceremony and whether there are any entertainment programs or change of clothes.

By understanding the preferences of the bride and groom, you will be able to shoot more appropriately.

#### Finding the Right Angle to Capture Both Bride and Groom

- **Composing the picture with the guests in front and the bride and groom at the back**



The main characters of a wedding are of course the bride and groom. Record their expressions clearly during the toast, speech, entertainment programs, and other scenes.

Another recommendation is to capture the face shots of the guests, then pan towards the groom. Picture composition containing the crowd of guests only lacks fun, so be sure to pay attention to the shooting angle and size.

#### Recording the Expressions and Comments of Guests

- **Setting the shot from eye level to chest level**



You can record comments from the guest by going around asking, "Please say a few words for the bride and groom".

This can be done at the guests' waiting room, when the bride and groom are changing, or during the entertainment programs.

#### Closing Up on the Bride's Face During the Thank You Speech

The climax of the event finally comes during the bride and groom's thank you speech and presentation of flowers. The touching words of appreciation from the bride and tears of joy from the parents are scenes that must not be missed.

Start by closing up on the bride's face using zoom. As the tears start to form in the bride's eyes, continue shooting for a little longer. Then, slowly zoom out to the wide angle to show the parents who are moved by the speech.

#### Advanced Operation with Two Camcorders

- **<Camcorder 1>**  
**Closing up on the bride and groom all the time**
- **<Camcorder 2>**  
**Recording the congratulatory messages from friends at the same time**



If video-editing is to be done, record using two camcorders so that a video with varying scenes can be created. You can try asking a close friend who has a camcorder at home.

Set the borrowed camcorder on a tripod to focus on taking close-up shots of the bride and groom. In this way, the other camcorder can be moved around to record other scenes, enabling an interesting video with changing scenes to be created through editing and compilation.

As most people own at least a digital camera nowadays, even if you are really unable to find an extra camcorder, inserting still pictures to the video at various points is also a good way to add variety. Do give it a try!

## Travel

Capture all the good times of your domestic or overseas trips!



### Bringing the Necessary Equipment

The necessary things to bring on a trip depends on your traveling purpose and the destination.

For overseas trips in particular, you have to think about what to bring in accordance to the local conditions.

Here are some suggestions for your consideration.

#### ■ Camcorder

Think about how many hours of shooting you will usually perform in a day. Be sure to prepare enough recording medium especially for long overseas trips.

If you are recording in SD cards, get ready the sufficient number of cards, including some for backup.

#### ■ Battery Pack

Prepare a battery pack that is ready for double the expected recording time in a day. For example, if you plan to record for 2 hours a day, prepare a battery pack that is ready for 4 hours (actual recording time).

For a day trip, you can prepare a battery with low capacity but for a long trip, do prepare a few batteries with high capacities.

#### ■ AC Adapter

The JVC AC adapter supports voltages from 100 V to 240 V, and hence can be used anywhere in the world.

Bring along the adapter if you are traveling for a long time. Charge the battery pack while sleeping so that you can record with full battery power the next day.

#### ■ Power Plug Adapters (P.18)



The shape of the power plug varies according to countries. Be sure to check the shape of the power plug beforehand, and bring the appropriate power plug adapter.

#### ■ Battery Charger



Recording cannot be performed when an AC adapter is connected to the camcorder for battery charging.

You can bring an additional battery charger to charge battery packs if you plan to use the camcorder for recording at night. You can also charge multiple battery packs by using both the battery charger and this camcorder at the same time.

#### ■ Tripod



A tripod is an essential item to take stable images. Select an appropriate tripod in accordance to your purpose and style of traveling, such as a compact one to be used on a table or one that is at least 1 m tall.

### Recording the Excitement Before Departure

It may be a little abrupt to start your travel video at the destination suddenly.

Record also the preparations prior to departure if it is a family trip, or the time when everyone is gathered at the meeting place if you are traveling with your friends.

For overseas trips, taking a shot of the signs and displays at the airport of the flight you are taking may be useful for future reference.



### Using Pan at the Places of Interest

Tourist spots with beautiful scenery or historical sites are places that you would certainly want to record.

To capture the magnificence of a scene which cannot be fitted into a single frame, try the panning technique.

Refer to the "Shooting Tips" found in this website on how to use panning effectively.

In addition, you may also like to take a shot of the signs or monuments that can often be found at the tourist spots.



### Showing Everyone Having a Good Time

When taking a video, it is rather dull to shoot only the scenery or historical sites.

Talk about your feelings while recording the breath-taking scenery of an attraction so that it will be an interesting scene to view later.

## Amusement Park

Take more shots of the smiling faces of everyone in the family!



### Taking Videos or Still Images According to the Attraction

You may choose to take videos all the time. However, you may want to take some still images too.

The following section explains the scenarios suitable for taking videos or still images.

#### ■ Scenarios suitable for taking videos



Scenarios with changes in body movement are suitable for taking videos. This includes situations where there are rapid changes in facial expressions or voices of surprise and delight.

\*Some amusement parks do not allow passengers to perform any recording. Be sure to check beforehand.

[Examples]

- Merry-go-round, go kart, coffee cup, etc.

#### ■ Scenarios suitable for taking still images (photos)



Scenarios with little movement of the subject are suitable for taking still images.

Try to take the still images from an angle such that the surroundings can be seen clearly.

[Examples]

- Carousel, ferris wheel, fun bicycle rides, etc.

### Inducing Responses by Calling Out





Videos with no waving of hands nor laughter are not only dull when you view them later, but also put the capability of the audio-recording function of the camcorder to a waste.

When recording, induce more reactions by enthusiastically waving your hands or shouting out "Is it fun?" and the like.

### Capturing the Best Moment in a Video as a Still Image

Shots with the eyes closed are often taken by accident. To reduce such mistakes, make use of the function to capture still images from videos. As videos are actually continuous recording of 60 still images within 1 minute, using this function allows you to select the best moment and save it as a still image.

"Capturing a Still Image in the Video during Playback" (P.50)



Photo by justthatgoodguyjim

[Creative Commons Attribution-No Derivative Works 3.0](#)

Video Playback in Progress



Photo by talkrhubarb

[Creative Commons Attribution-No Derivative Works 3.0](#)

Capturing a Still Image



Photo by justthatgoodguyjim

[Creative Commons Attribution-No Derivative Works 3.0](#)

Video Playback in Progress

### Advanced Operation with Backlight Compensation

It is useful to make use of backlight compensation when the subject's face is in backlight or when the expression cannot be seen clearly. Increase the brightness of the whole image by setting "BACKLIGHT COMP." if the faces appear too dark. Even the expressions of faces under shadows can be captured brightly and clearly.

"Setting Details" (P.28)

#### ■ <Without backlight compensation>









#### ■ <With backlight compensation>

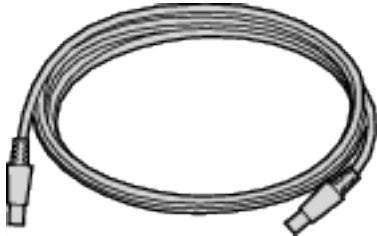

## Verifying the Accessories

If any of the items are missing or defective, consult your JVC dealer or the nearest JVC service center.

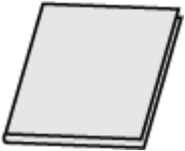
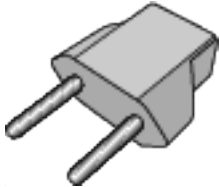
| Illustration  | Description  |
|---|--|
|    | AC Adapter<br>AP-V30M <ul style="list-style-type: none"> <li>Connects to this unit to charge the battery pack.<br/>It can also be used when recording or playing back videos indoors.</li> </ul> |
|    | Power Cord   |
|    | Battery Pack<br>BN-VG107E <ul style="list-style-type: none"> <li>Attaches to this unit to supply power.</li> </ul>   |
|    | AV Cable <ul style="list-style-type: none"> <li>Connects this unit to a TV to play back recorded images on the TV.</li> </ul>  |
|   | USB Cable<br>(Type A - Mini Type B) <ul style="list-style-type: none"> <li>Connects this unit to a PC.</li> </ul>  |
|  | CD-ROM <ul style="list-style-type: none"> <li>For installing the provided software "Everio MediaBrowser" on a PC.</li> </ul>   |
|  | Core Filter (GZ-MS230)   |
|  | Basic User Guide <ul style="list-style-type: none"> <li>Read well and keep in a safe place where it can be accessed easily when necessary.</li> </ul>  |
|  | Plug Adapter (AS only)   |

**Memo:**  
SD cards are sold separately.

"Types of Usable SD Card" (P.14)

When using the AC adapter overseas, please prepare a commercially available converter plug for the country or region of visit.

"Charging the Battery Pack Overseas" (P.18)

### Attaching the Core Filter to the DC cord

The core filter reduces interference. Connect the end of the cable with the core filter to this unit.

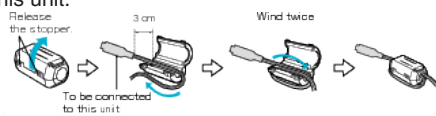

## Charging the Battery Pack

Charge the battery pack immediately after purchase and when the remaining battery power is low. The battery pack is not charged at the time of purchase.

1 Attach the battery pack.

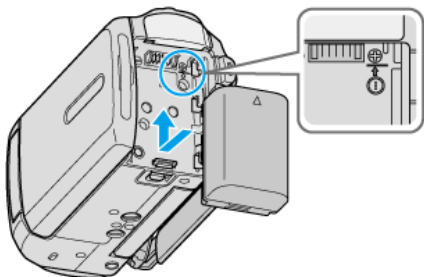

- Align the top of the battery with this unit, and slide in until the battery clicks into place.

2 Connect the AC adapter to the DC terminal.

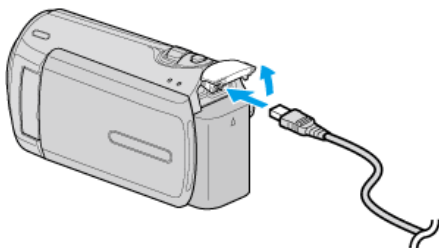

3 Plug in the power.

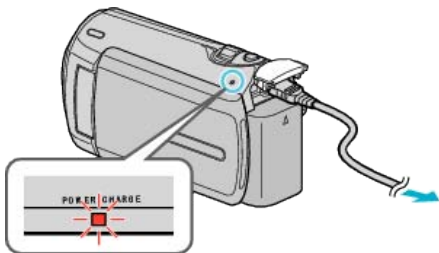

- The charging lamp blinks when charging is in progress. It goes out when charging is finished.

### CAUTION:

Be sure to use JVC battery packs.

- If you use any other battery packs besides JVC battery packs, safety and performance can not be guaranteed.
- Charging time: Approx. 1 h 50 m (using supplied battery pack)  
The charging time is when the unit is used at 25°C.  
If the battery pack is charged outside the room temperature range of 10°C - 35°C, charging may take a longer time or it may not start. The recordable and playable time may also be shortened under some usage conditions such as at low temperature.

### Rechargeable Batteries :

- When using the battery in a low temperature environment (10°C or below), the operating time may be shortened, or it may not function properly. When using this unit outdoors in the winter weather, warm the battery, such as by placing it in the pocket, before attaching it. (Keep away from direct contact with a warm pack.)
- Do not expose the battery to excessive heat, such as direct sunlight or fire.
- After removing the battery, store it in a dry place between 15°C to 25°C.
- If the battery pack is not to be used for a long time, use up the charge completely and detach it from this unit to prevent deterioration.

### Memo:

- You can connect this unit to the AC adapter to record for long hours indoors. (Battery charging begins when the LCD monitor is closed.)

## Detaching the Battery Pack

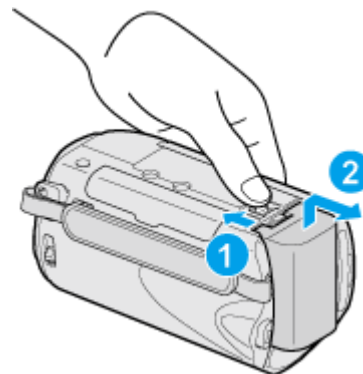

Slide the battery release lever to detach the battery from this unit.

## Approximate Battery Charging Time

| Battery Pack         | Charging Time |
|----------------------|---------------|
| BN-VG107E (Supplied) | 1 h 50 m      |
| BN-VG114E            | 2 h 30 m      |
| BN-VG121E            | 3 h 30 m      |

- When the battery life is reached, the recording time becomes shorter even if the battery pack is fully charged. (Replace the battery pack with a new one.)

\*The charging time is when the unit is used at 25°C.

If the battery pack is charged outside the room temperature range of 10°C - 35°C, charging may take a longer time or it may not start. The recordable and playable time may also be shortened under some usage conditions such as at low temperature.

## Grip Adjustment



- ① Flip the grip belt over.
- ② Adjust the length of the belt.
- ③ Fasten the grip belt.

### CAUTION:

- Be sure to fasten the grip belt properly.  
If the belt is loose, this unit may drop and result in injuries or damages.

## Hand Strap

When using the hand strap, loop it around your wrist.

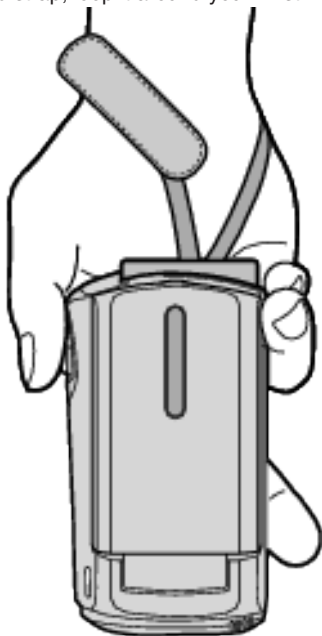

## Removing the Strap

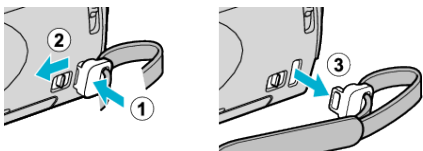

- While pressing ①, pull ② and remove the strap.

## Attaching the Strap

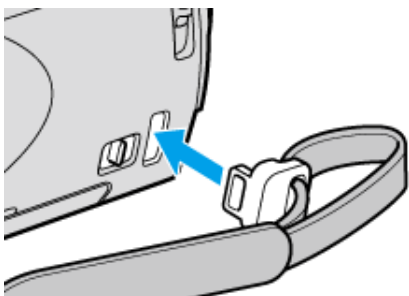

Push in firmly until it clicks into place.

## Inserting an SD Card (GZ-MS230)

When a commercially available SD card is inserted, recordings can still be made to the card without stopping when the remaining recording time on the built-in memory runs out.

"Types of Usable SD Card" (P.14)

"Approximate Video Recording Time" (P.36)

- 1 Close the LCD monitor.

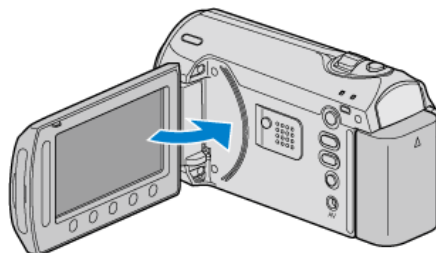

- 2 Open the slot cover.

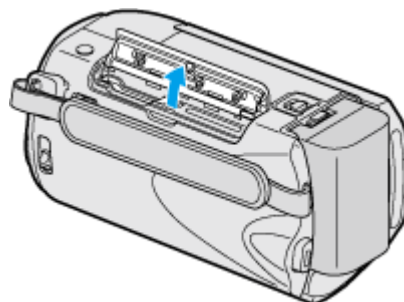

- 3 Insert an SD card.

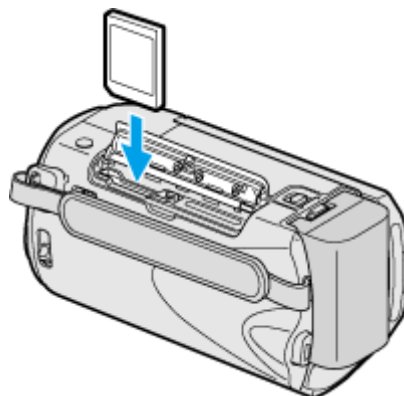

- Insert with the label facing outward.

### Warning

- Make sure not to insert the card in the wrong direction. It may cause damage to the unit and card.
- Turn off the power of this unit before inserting or removing a card.
- Do not touch the metal contact area when inserting the card.

### Memo:

- To record to the card, it is necessary to perform media settings. When no card is available, set media settings to "BUILT-IN MEMORY" for recording.

"REC MEDIA FOR VIDEO (GZ-MS230)" (P.95)

"REC MEDIA FOR IMAGE (GZ-MS230)" (P.96)

- To use cards that have been used on other devices, it is necessary to format (initialize) the card using "FORMAT SD CARD" from media settings.

"FORMAT SD CARD" (P.97)

### Removing the Card

Push the SD card inward once, then pull it out straight.

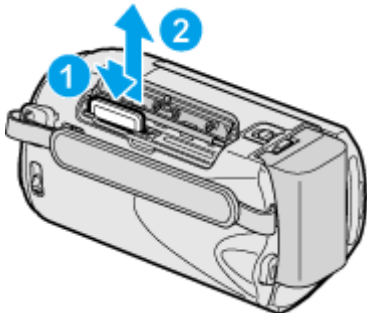

### Types of Usable SD Card

The following SD cards can be used on this unit. Operations are confirmed on the SD cards from the following manufacturers.

- Panasonic
- TOSHIBA
- SanDisk
- ATP

### SDHC Card



- Use a Class 4 or higher compatible SDHC card (4 GB to 32 GB) for video recording.

### SD Card



- This unit supports 256 MB to 2 GB SD cards.

**Memo:**

- Using SD cards (including SDHC cards) other than those specified above may result in recording failure or data loss.
- Class 4 and Class 6 are guaranteed to have a minimum transfer rate of 4 MB/s and 6 MB/s respectively during reading or writing of data.

### Inserting an SD Card (GZ-MS215)

Insert a commercially available SD card before recording. This unit comes with two SD card slots. When two SD cards are inserted, recordings can be continued on the other card even if one card is full.  
 "Types of Usable SD Card" (P.15)  
 "Approximate Video Recording Time" (P.36)

1 Close the LCD monitor.

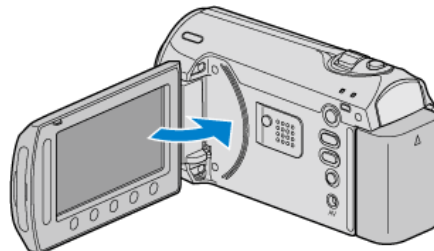

2 Open the slot cover.

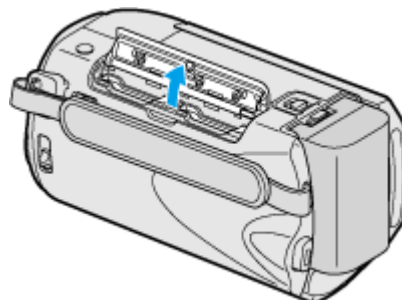

3 Insert an SD card into slot A.

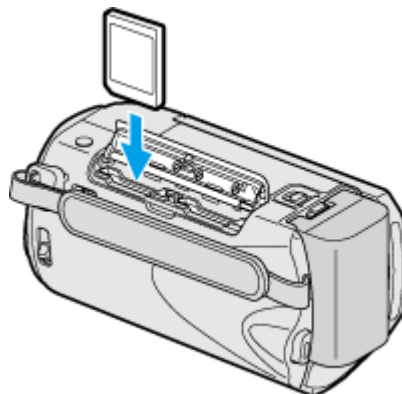

- Insert with the label facing outward.

| Warning  |
|--|
| <ul style="list-style-type: none"> <li>• Make sure not to insert the card in the wrong direction. It may cause damage to the unit and card.</li> <li>• Turn off the power of this unit before inserting or removing a card.</li> <li>• Make sure that a card is inserted in at least one slot. Recordings cannot be performed without any SD card inserted.<br/>"Media Settings Menu" (P.95)</li> <li>• Do not touch the metal contact area when inserting the SD card.</li> </ul> |

**Memo:**

- To use cards that have been used on other devices, it is necessary to format (initialize) the card using "FORMAT SD CARD" from media settings.

"FORMAT SD CARD" (P.97)

## Removing the Card

Push the SD card inward once, then pull it out straight.

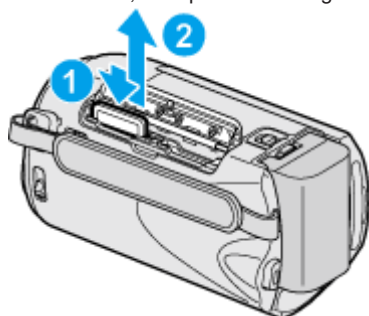

## Types of Usable SD Card

The following SD cards can be used on this unit.

Operations are confirmed on the SD cards from the following manufacturers.

- Panasonic
- TOSHIBA
- SanDisk
- ATP

## SDHC Card



- Use a Class 4 or higher compatible SDHC card (4 GB to 32 GB) for video recording.

## SD Card



- This unit supports 256 MB to 2 GB SD cards.

### Memo:

- Using SD cards (including SDHC cards) other than those specified above may result in recording failure or data loss.
- Class 4 and Class 6 are guaranteed to have a minimum transfer rate of 4 MB/s and 6 MB/s respectively during reading or writing of data.

## Clock Setting

The "SET DATE/TIME!" screen appears when you turn on this unit for the first time after purchase, when it has not been used for a long time, or when the clock is not set yet.

Set the clock before recording.

- 1 Open the LCD monitor.

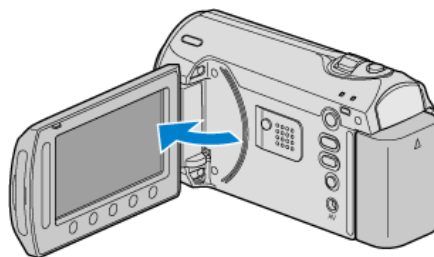

- This unit turns on.
- When the LCD monitor is closed, this unit turns off.

- 2 Select "YES" and touch  $\text{OK}$ .



- 3 Set the date and time.



- Use the slider to adjust the year, month, day, hour, and minute in order.
- Touch the operation buttons "←" / "→" to move the cursor.
- After setting the date and time, touch  $\text{OK}$ .

- 4 Select the region where you live and touch  $\text{OK}$ .



- The city name and time difference are displayed.
- Touch  $\text{OK}$  after the color of the selected region changes.

### Memo:

- The clock can be reset again later.
- "Resetting the Clock" (P.16)
- When using this unit overseas, you can set it to the local time for recording.
- "Setting the Clock to Local Time when Traveling" (P.18)
- You can turn on or off the clock display during playback mode.
- "ON-SCREEN DISPLAY" (P.84)
- Touch the slider and buttons around the screen with your fingers.
- The slider and buttons do not function if you touch them with your fingernails or with gloves on.
- The displays on the screen do not work even if you touch them.

### Resetting the Clock

Set the clock with "CLOCK ADJUST" from the menu.

1 Touch **Ⓜ** to display the menu.

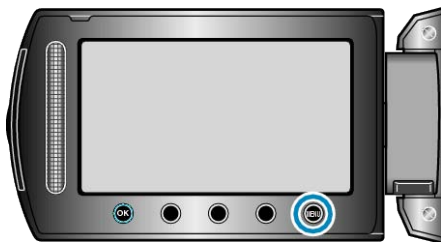

2 Select "CLOCK ADJUST" and touch **Ⓚ**.



3 Select "CLOCK SETTING" and touch **Ⓚ**.



4 Set the date and time.



- Use the slider to adjust the year, month, day, hour, and minute in order.
- Touch the operation buttons "←" / "→" to move the cursor.
- After setting the date and time, touch **Ⓚ**.

5 Select the region where you live and touch **Ⓚ**.



- The city name and time difference are displayed.
- Touch **Ⓚ** after the color of the selected region changes.

### Changing the Display Language

The language on the display can be changed.

1 Touch **Ⓜ** to display the menu.



2 Select "DISPLAY SETTINGS" and touch **Ⓚ**.

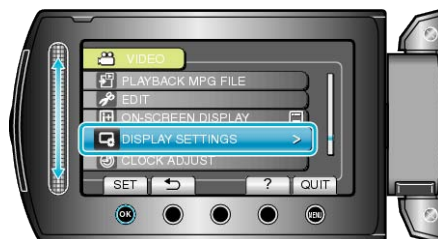

3 Select "LANGUAGE" and touch **Ⓚ**.



4 Select the desired language and touch **Ⓚ**.

### Using the Operation Buttons

Functions of the operation buttons may be displayed on the screen according to the feature in use.

Functions of the operation buttons will be displayed.

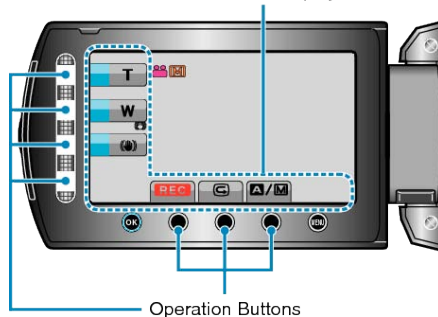

- To operate, touch the slider and buttons around the screen lightly with your fingers.

**Memo:** \_\_\_\_\_

- "Touch" denotes the touching of the operation buttons lightly.
- The slider and buttons do not function if you touch them with your fingernails or with gloves on.
- The displays on the screen do not work even if you touch them.

### Using the Slider

Slide the ball of your finger along the slider for smooth operations. While the slider is being pressed, the cursor moves automatically. Fine operations such as moving the cursor one by one can be performed by touching the slider.

- Refer to the operating instructions found in the animation on the Detailed User Guide.

**Memo:** \_\_\_\_\_



- The slider and buttons do not function if you touch them with your fingernails or with gloves on.
- The displays on the screen do not work even if you touch them.

## Grip Adjustment

When holding this unit, keep your elbows close to your sides to prevent camera shake.



### CAUTION:

- Be careful not to drop this unit during transportation.
- Guardians should pay close attention when this unit is being used by children.

### Memo:

- If camera shake is excessive, use the digital image stabilizer. "Reducing Camera Shake" (P.22)

## Tripod Mounting

This unit can be mounted on a tripod. This is useful for preventing camera shake and recording from the same position.

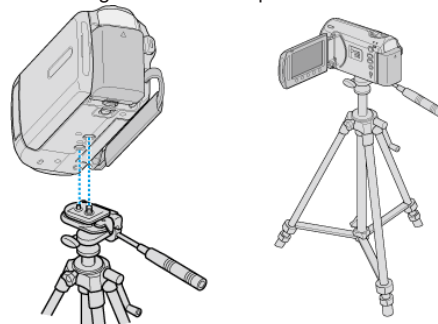

- To prevent this unit from falling off, check the tripod mounting screw holes and positioning holes on the unit carefully before mounting, and turn the screws until they are fastened firmly.

### CAUTION:

- To prevent injuries or damages which may result if this unit falls off, read the instruction manual of the tripod to be used and make sure that it is securely attached.

### Memo:

- It is recommended to use the tripod when recording in conditions prone to camera shake (such as in dark places or when zoomed to the telephoto end).
- Set "DIS" to (OFF) when using a tripod for recording. "Reducing Camera Shake" (P.22)

## Using this Unit Overseas

The shape of the power outlet varies according to countries and regions. To charge the battery pack, you need a converter plug that matches the shape of the outlet.

"Charging the Battery Pack Overseas" (P.18)

Change the date and time display to the local time by selecting your travel destination in "AREA SETTING" of "CLOCK ADJUST".

"Setting the Clock to Local Time when Traveling" (P.18)

When "ON" is selected in "SET FOR DAYLIGHT SAVING TIME" of "CLOCK ADJUST", the time is set 1 hour ahead.

"Setting Daylight Saving Time" (P.19)

## Charging the Battery Pack Overseas

The shape of the power outlet varies according to countries and regions. To charge the battery pack, you need a converter plug that matches the shape of the outlet.

| A | B | BF | C | O |
|---|---|----|---|---|
|   |   |    |   |   |

| North America         |                | Europe         |       | Oceania     |      | Middle East              |             |
|-----------------------|----------------|----------------|-------|-------------|------|--------------------------|-------------|
| United States         | A              | Iceland        | C     | Australia   | O    | Israel                   | C           |
| Canada                | A              | Ireland        | C     | Guam        | A    | Iran                     | C           |
| Mexico                | A              | United Kingdom | B, BF | Tahiti      | C    | Kuwait                   | B, C        |
| Asia                  |                | Italy          | C     | Tonga       | O    | Jordan                   | B, BF       |
| India                 | B, C, BF       | Austria        | C     | New Zealand | O    | Africa                   |             |
| Indonesia             | C              | Netherlands    | C     | Fiji        | O    | Algeria                  | A, B, BF, C |
| Singapore             | B, BF          | Canary Islands | C     | Latin       |      | Egypt                    | B, BF, C    |
| Sri Lanka             | B, C, BF       | Greece         | C     | Argentina   | O    | Guinea                   | C           |
| Thailand              | A, BF, C       | Switzerland    | C     | Colombia    | A    | Kerya                    | B, C        |
| South Korea           | A, C           | Sweden         | C     | Jamaica     | A    | Zambia                   | B, BF       |
| China                 | A, B, BF, C, O | Spain          | A, C  | Chile       | B, C | Tanzania                 | B, BF       |
| Japan                 | A              | Denmark        | C     | Haiti       | A    | Republic of South Africa | B, C, BF    |
| Nepal                 | C              | Germany        | C     | Panama      | A    | Mozambique               | C           |
| Pakistan              | B, C           | Norway         | C     | Bahamas     | A    | Morocco                  | C           |
| Bangladesh            | C              | Hungary        | C     | Puerto Rico | A    |                          |             |
| Philippines           | A, BF, O       | Finland        | C     | Brazil      | A, C |                          |             |
| Vietnam               | A, C           | France         | C     | Venezuela   | A    |                          |             |
| Hong Kong Special     |                | Belgium        | C     | Peru        | A, C |                          |             |
| Administrative Region | B, BF          | Poland         | B, C  |             |      |                          |             |
| Macau Special         |                | Portugal       | B, C  |             |      |                          |             |
| Administrative Region | B, C           | Romania        | C     |             |      |                          |             |
| Malaysia              | B, BF, C       |                |       |             |      |                          |             |

## Setting the Clock to Local Time when Traveling

Change the date and time display to the local time by selecting your travel destination in "AREA SETTING" of "CLOCK ADJUST". Restore the region settings after you returned from the trip.

1 Touch to display the menu.

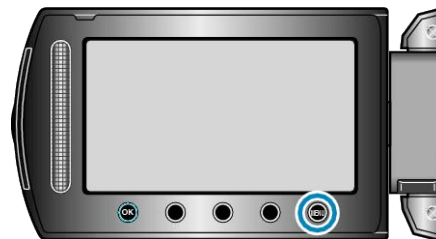

2 Select "CLOCK ADJUST" and touch .



3 Select "AREA SETTING" and touch .



4 Select the area you are traveling to and touch .



- The city name and time difference are displayed.

### Memo:

- Setting "AREA SETTING" changes the clock time such that time difference is accounted for. After returning to your country, re-select the region that was set initially to restore the original clock settings.

## Setting Daylight Saving Time

When "ON" is selected in "SET FOR DAYLIGHT SAVING TIME" of "CLOCK ADJUST", the time is set 1 hour ahead.

- 1 Touch **OK** to display the menu.

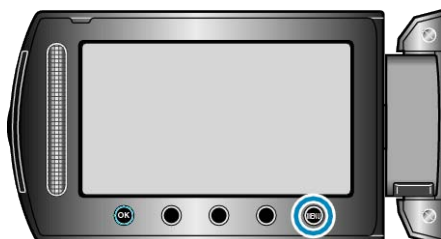

- 2 Select "CLOCK ADJUST" and touch **OK**.



- 3 Select "SET FOR DAYLIGHT SAVING TIME" and touch **OK**.



- 4 Set daylight saving time and touch **OK**.



### Memo:

- What is daylight saving time?  
Daylight saving time is the system of setting the clock 1 hour ahead for a fixed period in summer.  
It is used mainly in the Western countries.
- Restore the daylight saving time settings after you returned from the trip.

## Optional Accessories

You can record for a longer time by using the optional battery pack.

| Product Name   | Description  |
|--|--|
| Battery Pack <ul style="list-style-type: none"> <li>• BN-VG107E</li> <li>• BN-VG114E</li> <li>• BN-VG121E</li> </ul> | <ul style="list-style-type: none"> <li>• Provides a longer recording time than the battery pack that comes with this unit. It can also be used as a spare battery pack.</li> </ul> |
| Battery Charger <ul style="list-style-type: none"> <li>• AA-VG1</li> </ul>   | <ul style="list-style-type: none"> <li>• Enables the battery pack to be charged without using this unit.</li> </ul>  |

### Memo:

- For more information, refer to the catalog.
- BN-VG107E is the same battery pack that comes with this unit.
- File copying by connecting this unit to a DVD writer is not supported.

## Approximate Recording Time (Using Battery)

| Battery Pack                | Actual Recording Time | Continuous Recording Time |
|-----------------------------|-----------------------|---------------------------|
| <b>BN-VG107E (Supplied)</b> | 50 m                  | 1 h 30 m                  |
| <b>BN-VG114E</b>            | 1 h 40 m              | 3 h 5 m                   |
| <b>BN-VG121E</b>            | 2 h 35 m              | 4 h 40 m                  |

- The above are values when "LIGHT" is set to "OFF" and "LCD BACK-LIGHT" is set to "STANDARD".
- The actual recording time may be shorter if zooming is used or if recording is stopped repeatedly.  
(It is recommended to prepare battery packs ready for three times the expected recording time.)
- When the battery life is reached, the recording time becomes shorter even if the battery pack is fully charged.  
(Replace the battery pack with a new one.)

## Taking Videos in Auto Mode

You can record without worrying about the setting details by using the auto mode.

1 Open the lens cover.

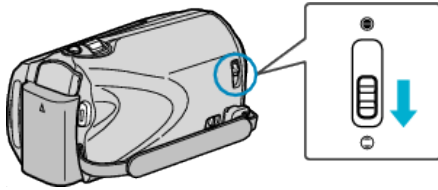

2 Open the LCD monitor and select the video mode.

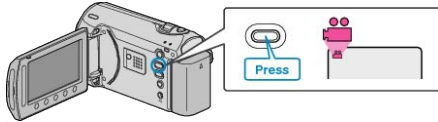

- The video mode icon appears.

3 Check if the recording mode is Auto.

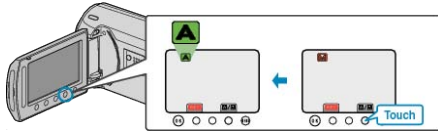

- If the mode is Manual, touch the **A/M** button. The mode changes between Auto and Manual with every touch.

4 Start recording.

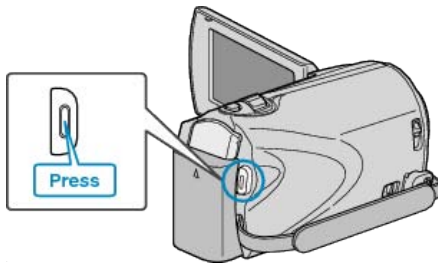

- Press again to stop.

## Indications During Video Recording

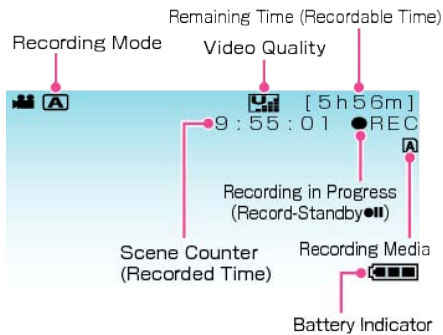

| Display Icon                            | Description   |
|---|---|
| <b>Recording Mode</b>                   | Press the <b>A/M</b> button to switch the recording mode between <b>A</b> (Auto) and <b>M</b> (Manual). |
| <b>Video Quality</b>                    | Displays the icon of the "VIDEO QUALITY" setting selected in the recording menu. "VIDEO QUALITY" (P.73) |
| <b>Remaining Time (Recordable Time)</b> | Displays the remaining time for video recording.  |
| <b>Recording in Progress</b>            | Appears when video recording is in progress.  |

|                                      |   |
|--------------------------------------|---|
| <b>Record-Stand-by</b>               | Appears when video recording is paused.   |
| <b>Scene Counter (Recorded Time)</b> | Displays the elapsed time of the video that is currently being recorded.  |
| <b>Recording Media</b>               | Displays the icon of the media where videos are recorded to. The recording media can be changed. "REC MEDIA FOR VIDEO (GZ-MS230)" (P.95) "VIDEO SLOT SELECTION (GZ-MS215)" (P.95) |
| <b>Battery Indicator</b>             | Displays the approximate remaining battery power. Details of the battery power can be displayed by pressing the INFO button. "Remaining Recording Time/Battery Power" (P.35)      |

## Operation Buttons for Video Recording

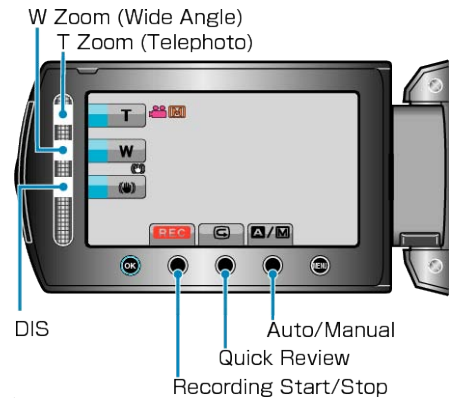

| Operation Button            | Description  |
|-----------------------------|--|
| <b>T/W Zoom</b>             | Allows the same functions as the zoom lever to be performed. Camera shake that often occurs when using the zoom lever can be minimized. "Zooming" (P.21) |
| <b>DIS</b>                  | Sets whether to reduce camera shake. "Reducing Camera Shake" (P.22)  |
| <b>Recording Start/Stop</b> | Functions as the START/STOP button. "RECORD BUTTON" (P.92)   |
| <b>Quick Review</b>         | Enables the most recently captured video to be viewed. "Checking the Captured Image Immediately" (P.22)  |
| <b>Auto/Manual</b>          | Switches the recording mode between Auto and Manual.   |

### Memo:

- The slider operation button cannot be used when the LCD monitor is flipped.
- The zoom appears when the slider is touched.

## Useful Settings for Recording

- The aspect ratio for recording can be switched between 16:9 and 4:3. "SELECT ASPECT RATIO" (P.75)
- Videos can be found easily during playback by categorizing them when recording. "Registering Files to Events Before Recording" (P.30)
- When "QUICK RESTART" is set to "ON", this unit turns on immediately if you open the LCD monitor within 5 minutes after the power is turned off by closing the monitor. "QUICK RESTART" (P.93)
- When "AUTO POWER OFF" is set to "ON", this unit turns itself off automatically to conserve power when it is not operated for 5 minutes. (only when using the battery pack) "AUTO POWER OFF" (P.91)

### CAUTION:

- Do not expose the lens to direct sunlight.
- Do not use this unit in the rain, snow, or places with high humidity like the bathroom.
- Do not use this unit in places subject to excessive humidity or dust, as well as places exposed to steam or smoke directly.
- The access lamp lights up when video recording is in progress. Do not remove the battery pack, AC adapter, or SD card when the lamp is lighted.
- Make a backup of important recorded data  
It is recommended to copy your important recorded data to a DVD or other recording media for storage. JVC will not be responsible for any lost data.

### Memo:

- Before recording an important scene, it is recommended to conduct a trial recording.
- Check the remaining recording time in the media before you start shooting. If there is not enough space, move (copy) the data to a PC or disc.
- Do not forget to make copies after recording!
- Recording stops automatically as it cannot be performed for 12 or more consecutive hours according to specifications. (It may take some time to resume recording.)
- For long recordings, the file is split into two or more files if the size exceeds 4 GB.
- You can connect this unit to the AC adapter to record for long hours indoors.

## Zooming

The angle of view can be adjusted using zoom.

- Use the W end (wide angle end) to shoot a wider field of view.
- Use the T end (telephoto end) to magnify the subject for shooting.

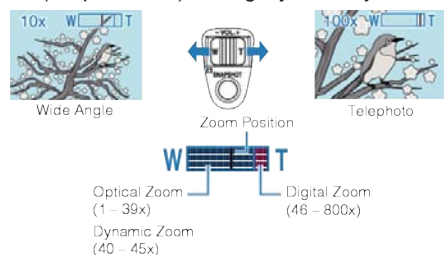

- You can also use the slider's T/W zoom to zoom.

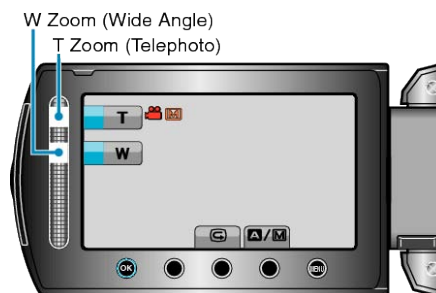

### Memo:

- You can expand the zoom area without degrading the image quality by using dynamic zoom.
- When digital zoom is used, the image becomes grainy as it is digitally enlarged.
- The zoom ratio range can be changed.

"ZOOM" (P.74)

## Capturing Still Images During Video Recording

Still images can be captured by pressing the SNAPSHOT button while in the video mode (standby or recording).

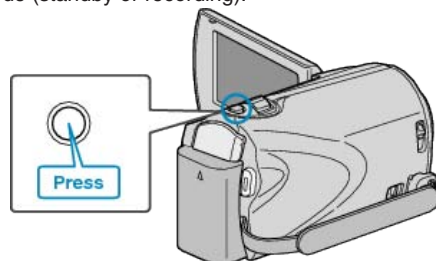

- "PHOTO" lights up on the screen when a still image is being captured.



- The still images captured during video recording are saved to the destination set in media settings.

"REC MEDIA FOR IMAGE (GZ-MS230)" (P.96)

"IMAGE SLOT SELECTION (GZ-MS215)" (P.96)

### Memo:

- The size of the still images captured in the video mode varies with the "SELECT ASPECT RATIO" setting.

"16:9" : 640×360

"4:3" : 640×480

"SELECT ASPECT RATIO" (P.75)

- The picture quality varies with the "IMAGE QUALITY" setting.

"Changing Still Image Picture Quality" (P.79)

- When an effect (black and white/sepia) is applied to the video, the same effect will be applied to the still image.

"EFFECT (GZ-MS230)" (P.81)

## Reducing Camera Shake

When DIS is turned on, camera shake during recording can be effectively reduced.



- The setting of DIS switches with every touch.

| Display              | Setting  |
|----------------------|--|
| (Image stabilizer 1) | Activates image stabilizer.  |
| (Image stabilizer 2) | Reduces camera shake more effectively when shooting bright scenes on the wide angle end.<br>*Only on the wide angle end (approx. 5x) |
| (OFF)                | Deactivates image stabilizer.  |

### Memo:

- It is recommended to switch off this mode when using a tripod and recording a subject with little movement.
- Complete stabilization may not be possible if camera shake is excessive.
- This setting is effective for video recording only.

## Checking the Captured Image Immediately

You can check the most recently captured images while in the recording mode. (Quick Review)



### Memo:

- You can also delete the image after checking.
- Quick Review can no longer recall the most recently captured image once the power is turned off.  
Use the playback mode to check the image in this case.

## Taking Still Images in Auto Mode

You can record without worrying about the setting details by using the auto mode.

- 1 Open the lens cover.

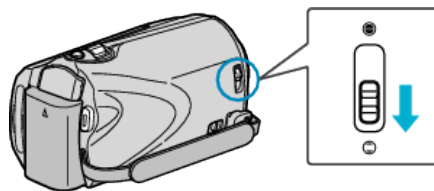

- 2 Open the LCD monitor and select the still image mode.



- The still image mode icon appears.

- 3 Check if the recording mode is Auto.

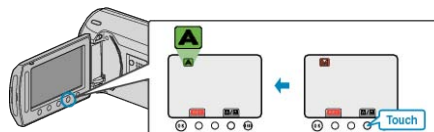

- If the mode is Manual, touch the button. The mode changes between Auto and Manual with every touch.

- 4 Set the focus on the subject.

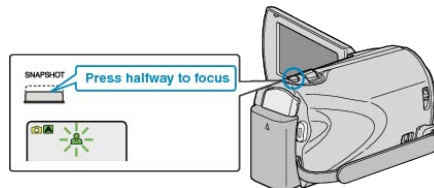

- When focused, the focus icon lights up in green.

- 5 Take a still image.

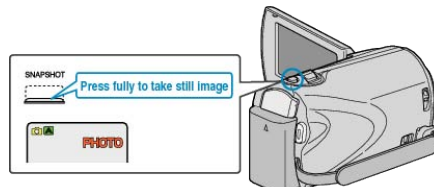

- PHOTO lights up when a still image is being captured.

## Indications During Still Image Recording

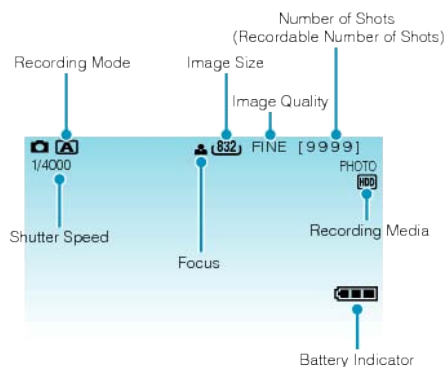

| Display Icon  | Description  |
|---|--|
| <b>Recording Mode</b>                               | Press the <b>A/M</b> button to switch the recording mode between <b>A</b> (Auto) and <b>M</b> (Manual).  |
| <b>Image Size</b>                                   | Displays the icon of the image size.<br>• The setting of image size cannot be changed.   |
| <b>Image Quality</b>                                | Displays the icon of the "IMAGE QUALITY" setting selected in the recording menu.<br>"IMAGE QUALITY" (P.79)   |
| <b>Number of Shots (Recordable Number of Shots)</b> | Displays the remaining number of shots for still image recording.  |
| <b>Shutter Speed</b>                                | Displays the shutter speed.  |
| <b>Focus</b>  | Lights up in green when focused.   |
| <b>Recording in Progress</b>                        | Appears when a still image is being captured.  |
| <b>Recording Media</b>                              | Displays the icon of the media where still images are recorded to.<br>The recording media can be changed.<br>"REC MEDIA FOR IMAGE (GZ-MS230)" (P.96)<br>"IMAGE SLOT SELECTION (GZ-MS215)" (P.96) |
| <b>Battery Indicator</b>                            | Displays the approximate remaining battery power. Details of the battery power can be displayed by pressing the INFO button.<br>"Remaining Recording Time/Battery Power" (P.35)                  |

## Operation Buttons for Still Image Recording

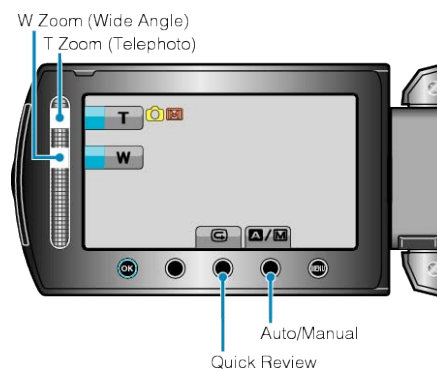

| Operation Button    | Description  |
|---------------------|--|
| <b>T/W Zoom</b>     | Functions as the zoom lever.<br>"Zooming" (P.24)   |
| <b>Quick Review</b> | Enables the most recently captured still image to be viewed.<br>"Checking the Captured Image Immediately" (P.24) |
| <b>Auto/Manual</b>  | Switches the recording mode between Auto and Manual.   |

### Memo:

- The slider operation button cannot be used when the LCD monitor is flipped.
- The zoom appears when the slider is touched.

## Useful Settings for Recording

- When "QUICK RESTART" is set to "ON", this unit turns on immediately if you open the LCD monitor within 5 minutes after the power is turned off by closing the monitor.

"QUICK RESTART" (P.93)

- When "AUTO POWER OFF" is set to "ON", this unit turns itself off automatically to conserve power when it is not operated for 5 minutes. (only when using the battery pack)

"AUTO POWER OFF" (P.91)

### CAUTION:

- Do not expose the lens to direct sunlight.
- Do not use this unit in the rain, snow, or places with high humidity like the bathroom.
- Do not use this unit in places subject to excessive humidity or dust, as well as places exposed to steam or smoke directly.
- The access lamp lights up when still image recording is in progress. Do not remove the battery pack, AC adapter, or SD card when the lamp is lighted.

### Memo:

- Before recording an important scene, it is recommended to conduct a trial recording.
- DIS does not work when recording still images.

## Zooming

The angle of view can be adjusted using zoom.

- Use the W end (wide angle end) to shoot a wider field of view.
- Use the T end (telephoto end) to magnify the subject for shooting.

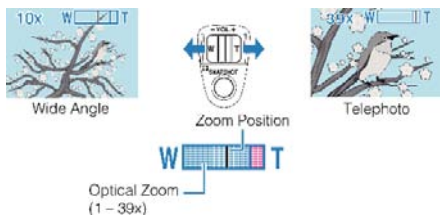

- You can also use the slider's T/W zoom to zoom.

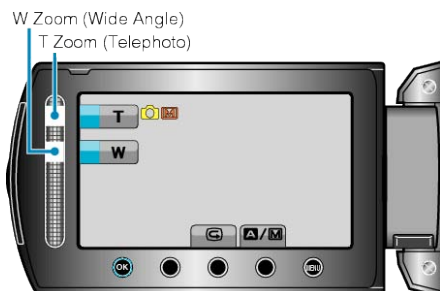

**Memo:**

- Only optical zoom is available in the still image recording mode.

## Checking the Captured Image Immediately

You can check the most recently captured images while in the recording mode. (Quick Review)

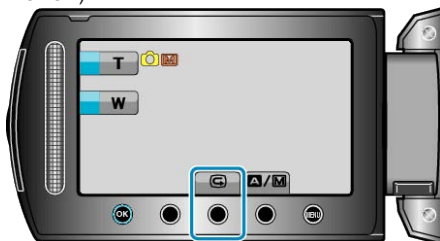

**Memo:**

- You can also delete the image after checking.
- Quick Review can no longer recall the most recently captured image once the power is turned off. Use the playback mode to check the image in this case.

## Manual Recording

You can adjust settings, such as brightness and shutter speed, by using the manual mode.

Manual recording can be set for both video and still image modes.

- 1 Select video or still image mode.

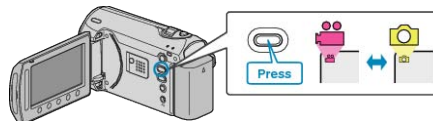

- The video or still image mode icon appears.

- 2 Select the Manual recording mode.

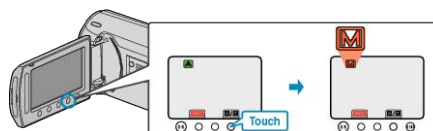

- The mode changes between Auto and Manual with every touch.

- 3 Start recording.

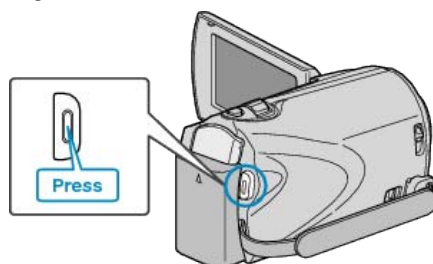

- Press again to stop.

**Memo:**

- The manual settings are displayed only in the manual mode.



## Manual Recording Menu

The following items can be set.

| Name                        | Description  |
|-----------------------------|--|
| SCENE SE-<br>LECT           | <ul style="list-style-type: none"> <li>Recordings that suit the shooting conditions can be performed easily.</li> </ul> "Scene Selection" ( P.25)  |
| FOCUS                       | <ul style="list-style-type: none"> <li>Use manual focus if the subject is not focused automatically.</li> </ul> "Adjusting Focus Manually" ( P.26)   |
| BRIGHT-<br>NESS AD-<br>JUST | <ul style="list-style-type: none"> <li>Overall brightness on the screen can be adjusted.</li> <li>Use this when recording in a dark or bright location.</li> </ul> "Adjusting Brightness" ( P.27)                        |
| SHUTTER<br>SPEED            | <ul style="list-style-type: none"> <li>Shutter speed can be adjusted.</li> <li>Use this when shooting a fast-moving subject or to emphasize the subject's movement.</li> </ul> "Setting Shutter Speed" ( P.27)           |
| WHITE BAL-<br>ANCE          | <ul style="list-style-type: none"> <li>Overall color on the screen can be adjusted.</li> <li>Use this when the color on the screen appears differently from the actual color.</li> </ul> "Setting White Balance" ( P.28) |
| BACKLIGHT<br>COMP.          | <ul style="list-style-type: none"> <li>Corrects the image when the subject appears dark due to backlight.</li> <li>Use this when shooting against the light.</li> </ul> "Setting Backlight Compensation" ( P.28)         |
| METERING<br>AREA/ TYPE      | <ul style="list-style-type: none"> <li>Brightness of a specified area can be set as the standard.</li> </ul> "Setting Metering Area" ( P.29)   |
| EFFECT                      | <ul style="list-style-type: none"> <li>Images that look like old photographs or black-and-white movies can be taken.</li> </ul> "Recording with Effects (GZ-MS230)" ( P.29)  |
| TELE MAC-<br>RO             | <ul style="list-style-type: none"> <li>Use this to take close-up (macro) shots of the subject.</li> </ul> "Taking Close-up Shots" ( P.30)  |

## Scene Selection

Common scenes that are often encountered can be recorded with the most suitable settings.

1 Touch  to display the menu.

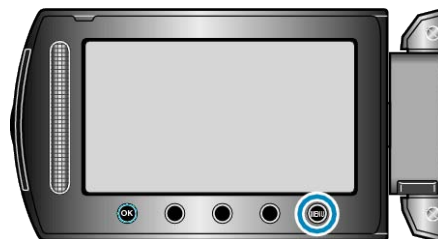

2 Select "MANUAL SETTING" and touch .



3 Select "SCENE SELECT" and touch .













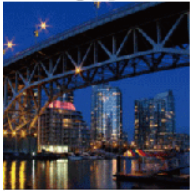

4 Select the scene and touch .

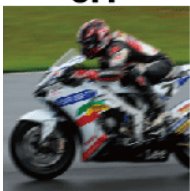

• After setting, touch .

\*The image is only an impression.

| Setting    | Effect   |
|------------|--|
| NIGHT EYE  | Increases gain and brightens the scene automatically when the surrounding is dark.<br>To prevent camera shake, use a tripod.<br><b>OFF</b>  <b>ON</b>  |
| NIGHT      | Captures night scenes naturally.<br><b>OFF</b>  <b>ON</b>    |
| PORTRAIT   | Blurs the background to bring out the people in the picture.<br><b>OFF</b>  <b>ON</b>    |
| SPORTS     | Captures fast-moving subjects clearly in every single frame.<br><b>OFF</b>  <b>ON</b>    |
| SNOW       | Prevents the subject from appearing too dark when recording snow scenes on a sunny day.<br><b>OFF</b>  <b>ON</b>                                   |
| SPOT-LIGHT | Prevents the human subject from appearing too bright under light.<br><b>OFF</b>  <b>ON</b>   |

## Adjusting Focus Manually

Set this when the focus is not clear in "AUTO" or when manual focusing is desired.

1 Touch  to display the menu.

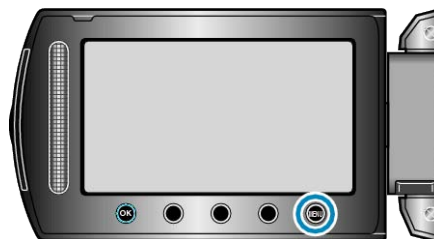

2 Select "MANUAL SETTING" and touch .



3 Select "FOCUS" and touch .



4 Select "MANUAL" and touch .



5 Adjust the focus with the slider.



- Slide upward to focus on a distant subject.
- Slide downward to focus on a near subject.

6 Touch  to confirm.



### Memo:

- A subject that is focused at the telephoto (T) end remains in focus when it is zoomed out to the wide angle (W) end.

## Adjusting Brightness

You can adjust the brightness to your preferred level.

1 Touch **MENU** to display the menu.

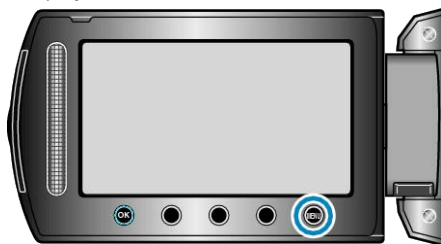

2 Select "MANUAL SETTING" and touch **OK**.



3 Select "BRIGHTNESS ADJUST" and touch **OK**.



4 Select "MANUAL" and touch **OK**.



5 Select the brightness value with the slider.



- Compensation range during video recording: -6 to +6
- Compensation range during still image recording: -2.0 to +2.0
- Slide upward to increase the brightness.
- Slide downward to decrease the brightness.

6 Touch **OK** to confirm.



Memo: \_\_\_\_\_

- Settings can be adjusted separately for videos and still images.

## Setting Shutter Speed

You can set the shutter speed to suit the type of subject.

1 Touch **MENU** to display the menu.

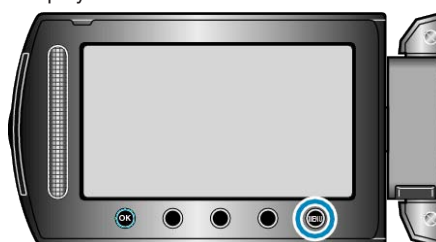

2 Select "MANUAL SETTING" and touch **OK**.



3 Select "SHUTTER SPEED" and touch **OK**.



4 Select "MANUAL" and touch **OK**.



5 Select the shutter speed with the slider.



- Shutter speed can be set from 1/2 to 1/4000. (Up to 1/1000 for still image.)
- Slide upward to increase the shutter speed.
- Slide downward to decrease the shutter speed.

6 Touch **OK** to confirm.



Memo: \_\_\_\_\_

## Recording

- Settings can be adjusted separately for videos and still images.

### Setting White Balance

You can set the color tone to suit the light source.

- 1 Touch **MENU** to display the menu.

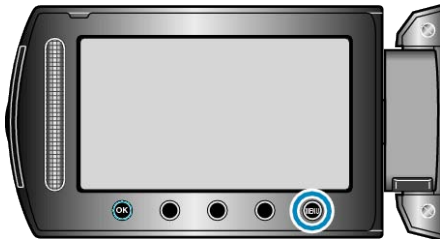

- 2 Select "MANUAL SETTING" and touch **OK**.



- 3 Select "WHITE BALANCE" and touch **OK**.



- 4 Select the white balance setting and touch **OK**.



| Setting | Details  |
|---------|--|
| AUTO    | Adjusts automatically to the natural colors.                     |
| MWB     | Use this when the problem of unnatural colors is not resolved.   |
| FINE    | Set this when shooting outdoors on a sunny day.                  |
| CLOUD   | Set this when shooting on a cloudy day or inside a shade.        |
| HALOGEN | Set this when shooting under illumination such as a video light. |

### Using MWB

- 1 Hold a sheet of plain white paper in front of the lens so that the white paper fills the screen.
- 2 Select "MWB" and keep touching **OK**.
  - The cursor blinks.
- 3 Release **OK** after the menu disappears.

### Setting Backlight Compensation

You can correct the image when the subject appears too dark due to backlight.

- 1 Touch **MENU** to display the menu.

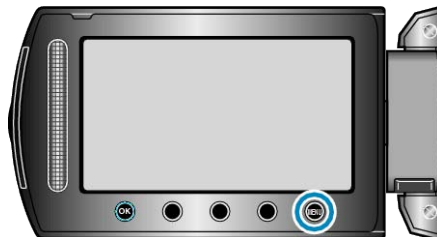

- 2 Select "MANUAL SETTING" and touch **OK**.



- 3 Select "BACKLIGHT COMP." and touch **OK**.



- 4 Select "ON" and touch **OK**.



## Setting Metering Area

You can set the brightness of a specified area as the standard.

1 Touch **MENU** to display the menu.

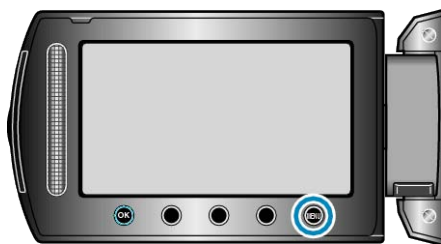

2 Select "MANUAL SETTING" and touch **OK**.



3 Select "METERING AREA/ TYPE" and touch **OK**.



4 Select "SPOT" and touch **OK**.



- When "SPOT" is selected, select the position of the spot frame by touching the operation buttons "←"/"→". After selecting, touch **OK** to confirm.

## Recording with Effects (GZ-MS230)

You can add various effects to videos and still images to create a different atmosphere from the usual recording.



\*The image is only an impression.

1 Touch **MENU** to display the menu.

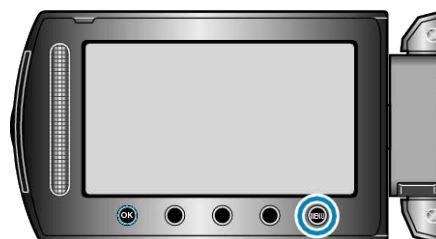

2 Select "MANUAL SETTING" and touch **OK**.



3 Select "EFFECT" and touch **OK**.



4 Select the effect setting and touch **OK**.



| Setting       | Details  |
|---------------|--|
| OFF           | No effect.   |
| SEPIA         | Gives images a brownish tint like old photographs.   |
| BLACK & WHITE | Records in black and white like old TV images.   |
| CLASSIC FILM  | Skips frames to give images of the effect of an old movie. <ul style="list-style-type: none"> <li>This can only be set in the video mode.</li> </ul>                           |
| STROBE        | Enables the image to look like a series of consecutive snapshots by skipping frames. <ul style="list-style-type: none"> <li>This can only be set in the video mode.</li> </ul> |

### Memo:

- Settings can be adjusted separately for videos and still images.

### Taking Close-up Shots

You can take close-up shots of an object using the tele macro function.



\*The image is only an impression.

1 Touch **MENU** to display the menu.



2 Select "MANUAL SETTING" and touch **OK**.



3 Select "TELE MACRO" and touch **OK**.



4 Select "ON" and touch **OK**.



| Setting | Details  |
|---------|--|
| OFF     | Enables close-up shots up to 1 m at the telephoto (T) end.<br>Enables close-up shots up to 5 cm at the wide angle (W) end.   |
| ON      | Enables close-up shots up to 50 cm at the telephoto (T) end.<br>Enables close-up shots up to 5 cm at the wide angle (W) end. |

**CAUTION:**

- When you are not taking close-up shots, set TELE MACRO to "OFF". Otherwise, the image may be blur.

### Registering Files to Events Before Recording

Videos can be found easily during playback by categorizing them when recording.

1 Select video mode.

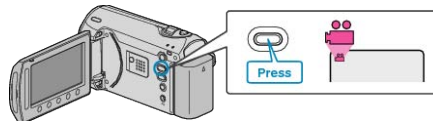

2 Touch **MENU** to display the menu.

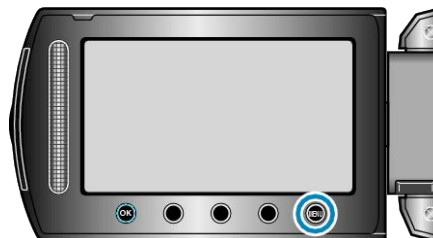

3 Select "REGISTER EVENT" and touch **OK**.



4 Select the event type and touch **OK**.



| Event Type      |
|-----------------|
| VACATION        |
| HOLIDAY         |
| SPORTS          |
| ANNIVERSARY     |
| CONGRATULATIONS |
| BABY            |
| SON             |
| DAUGHTER        |
| BIRTHDAY        |
| GRADUATION      |

- An icon appears on the screen and the video is recorded under the selected event. (Videos will continue to be recorded to the same event until a change is made.)

**Memo:**

- To cancel event registration, touch "CANCEL" in step 4.
  - The registered event can be changed again later.
- "Changing the Event of the Currently Displayed File" (P.48)  
 "Changing the Event of the Selected Files" (P.49)

## Taking Videos in YouTube Format

You can share your enjoyable memories with family and friends easily by posting your videos on the video sharing website YouTube. Through upload shooting, videos that are suitable for uploading to YouTube (within 10 minutes) may be taken directly.

### Memo:

For more information on YouTube, please visit the following website.  
<http://www.youtube.com/>

1 Select video mode.

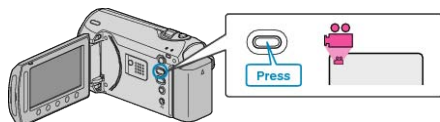

- The video mode icon appears.

2 Press the UPLOAD/EXPORT button to display the UPLOAD SETTINGS/EXPORT SETTINGS menu.

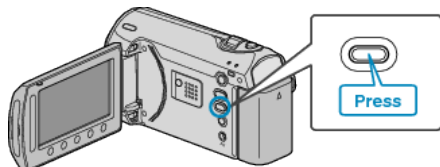

3 Select "UPLOAD SHOOTING" and touch the  $\odot$  button.



- The mode switches between ON and OFF with every press.
- To cancel this setting, set to "OFF".
- After setting, touch the  $\leftarrow$  button.

4 Start recording.

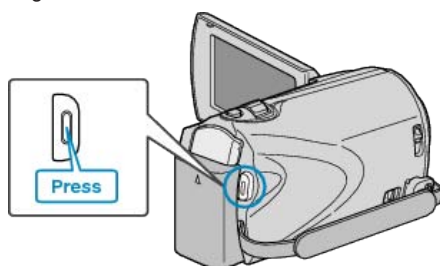

- Press again to stop.
- The maximum recording length of a video in upload mode is 10 minutes. Recording stops automatically after 10 minutes.

### Memo:

- Upload recording can only be performed for up to 10 minutes, the time limit of YouTube.
- Changing videos to the file format for uploading cannot be performed on this unit.  
To upload video files, refer to "Uploading Videos" below.
- The upload recording icon disappears when recording stops.  
To record another video in upload mode, perform the settings again.

## Uploading Videos

You can upload your videos to YouTube using the provided software "Everio MediaBrowser".

Install the software on your PC and connect this unit to the PC.

- For details on how to use the software, refer to the help file.  
"Installing the Provided Software" (P.64)  
"Connecting this Unit to PC" (P.64)

## Trouble with Uploading Videos

- Check if you have created an account with YouTube.  
(You need a YouTube account to upload files to YouTube.)
- Refer to "Q&A", "Latest Information", "Download Information", etc. in "Click for Latest Product Info" in the help file of the provided software "Everio MediaBrowser".

## Taking Videos in iTunes Format

By recording with the EXPORT setting turned on, you can transfer the videos to Apple's software "iTunes" when this unit is connected to a PC. "LIB." is displayed when recording videos in iTunes format. Use the provided software to transfer the videos. "Installing the Provided Software" (P.64)

**Memo:**

For more information on iTunes and iPod, please visit the following website.

<http://www.apple.com/itunes/>

1 Select video mode.

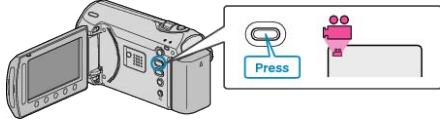

- The video mode icon appears.

2 Press the UPLOAD/EXPORT button to display the UPLOAD SETTINGS/EXPORT SETTINGS menu.

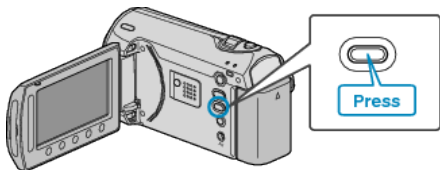

3 Select "EXPORT SHOOTING" and touch the OK button.



- The mode switches between ON and OFF with every press.
- To cancel this setting, set to "OFF".
- After setting, touch the ↶ button.

4 Start recording.

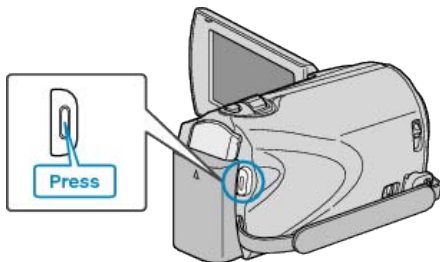

- Press again to stop.

## Transferring Recorded Videos to iPod

You can export videos to iTunes using the provided software "Everio MediaBrowser".

Install the software on your PC and connect this unit to the PC.

- For details on how to use the software, refer to the help file.
- For details on transferring files to iPod, refer to the help file of iTunes.

"Installing the Provided Software" (P.64)

"Backing Up All Files" (P.65)

## Trouble with Exporting Files to iTunes

- Refer to "Q&A", "Latest Information", "Download Information", etc. in "Click for Latest Product Info" in the help file of the provided software "Everio MediaBrowser".

## Recording at Intervals (TIME-LAPSE RECORDING)

This function enables the changes of a scene that occur slowly over a long period to be shown within a short time by taking frames of it at a certain interval.

This is useful for making observations such as the opening of a flower bud.

1 Select video mode.

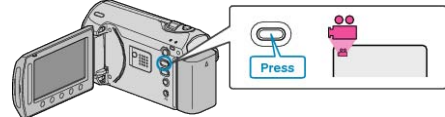

2 Touch MENU to display the menu.

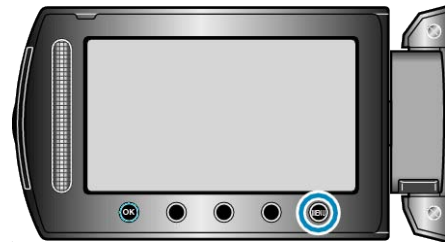

3 Select "TIME-LAPSE RECORDING" and touch OK.



4 Select a recording interval (1 to 80 seconds) and touch OK.



- The greater the number of seconds, the longer the recording interval.

5 Start recording.

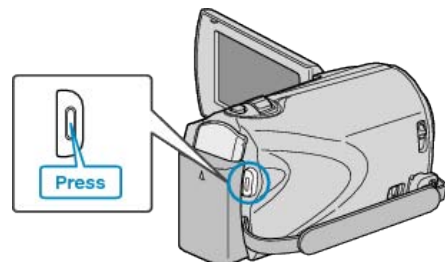

- A frame is taken at intervals of the selected period.
- When the recording interval is set to "20SEC INTERVAL" or higher, this unit switches to the power-saving mode between recordings. At the next point to record, the power-saving mode will be turned off and recording will start automatically.
- Press the START/STOP button again to stop recording.



## Indications During Time-Lapse Recording

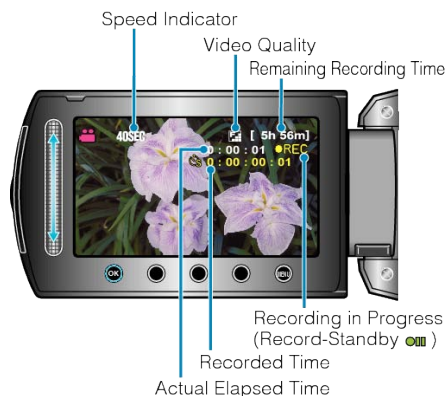

| Display                         | Description   |
|---------------------------------|---|
| <b>Speed Indicator</b>          | Displays the recording interval that is set.  |
| <b>Video Quality</b>            | Displays the icon of the video quality that is set.   |
| <b>Remaining Recording Time</b> | Remaining time left to record with the currently selected video quality.                    |
| <b>Recording in Progress</b>    | Appears when video recording is in progress. When in the power-saving mode, it blinks.      |
| <b>Record-Standby</b>           | Appears when video recording is paused.   |
| <b>Actual Elapsed Time</b>      | Displays the actual elapsed time after recording starts.                                    |
| <b>Recorded Time</b>            | Displays the actual recorded time of the video. Recorded time increases in units of frames. |

## Time-Lapse Setting

The greater the number of seconds, the longer the recording interval.

| Setting                | Details   |
|------------------------|---|
| <b>OFF</b>             | Deactivates the function.   |
| <b>1SEC INTER-VAL</b>  | Takes a frame at 1-second intervals. Recorded videos will be played back at 30 times speed.     |
| <b>2SEC INTER-VAL</b>  | Takes a frame at 2-second intervals. Recorded videos will be played back at 60 times speed.     |
| <b>5SEC INTER-VAL</b>  | Takes a frame at 5-second intervals. Recorded videos will be played back at 150 times speed.    |
| <b>10SEC INTER-VAL</b> | Takes a frame at 10-second intervals. Recorded videos will be played back at 300 times speed.   |
| <b>20SEC INTER-VAL</b> | Takes a frame at 20-second intervals. Recorded videos will be played back at 600 times speed.   |
| <b>40SEC INTER-VAL</b> | Takes a frame at 40-second intervals. Recorded videos will be played back at 1 200 times speed. |
| <b>80SEC INTER-VAL</b> | Takes a frame at 80-second intervals. Recorded videos will be played back at 2 400 times speed. |

### CAUTION:

- Audio cannot be recorded during time-lapse recording.
- Zooming, simultaneous still image recording, and DIS are not available in time-lapse recording.
- When recording is stopped with the recorded time less than "0:00:00:17", the video will not be saved.
- Automatic switching of recording media is disabled in time-lapse recording.

### Memo:

- Settings of time-lapse recording are saved even when the power is turned off. When the power is turned on, "TIME LAPSE" appears on the screen.
- Recording stops automatically 99 hours after it is started.
- Make use of a tripod and AC adapter for time-lapse recordings with long intervals. It is also recommended to fix the focus and white balance manually.

"Tripod Mounting" ( P.17)

"Adjusting Focus Manually" ( P.26)

"Setting White Balance" ( P.28)

## Recording Automatically by Sensing Movements (AUTO REC)

This function enables the unit to record automatically by sensing the changes in subject's movement (brightness) within the red frame displayed on the LCD monitor. (AUTO REC)  
It can be set for both video and still image modes.

1 Select video or still image mode.

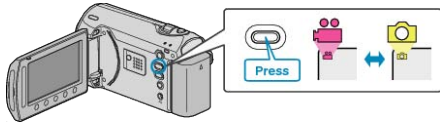

2 Compose the picture according to the subject.

- Adjust the angle of view with the zoom, etc.

3 Touch **MEM** to display the menu.

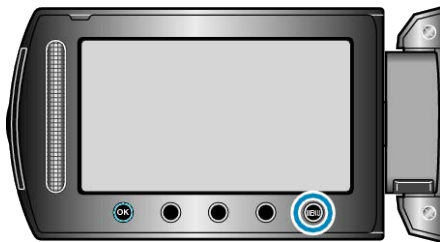

4 Select "AUTO REC" and touch **OK**.



5 Select "ON" and touch **OK**.



6 Recording starts automatically when the subject within the red frame moves.



- A red frame appears 2 seconds after the menu display disappears.
- For video recording, recording continues while there are still movements of the subject (changes in brightness) within the red frame. When there are no more movements of the subject (changes in brightness) within the red frame, recording will stop in 5 seconds.
- To stop video recording manually, press the START/STOP button. However, as the AUTO REC setting remains at ON even after the video recording is stopped, recording starts again when movements of the subject (changes in brightness) are detected within the red frame. To cancel AUTO REC, set it to "OFF".

### CAUTION:

- The only manual recording setting available is "TELE MACRO". The rest are all set to "AUTO".
- Digital zoom, DIS, self-timer, and continuous shooting are not available after AUTO REC is set.
- AUTO REC cannot be used together with TIME-LAPSE RECORDING. When both are set, priority is given to TIME-LAPSE RECORDING.
- "VIDEO QUALITY" and "SELECT ASPECT RATIO" cannot be changed after AUTO REC is selected. Set them before selecting AUTO REC.
- The auto power off and power-saving modes are not available after AUTO REC is set.

### Memo:

- Recording stops when there are no changes for 5 seconds during video recording.
- Recording may not start when the movements of the subject within the red frame are too fast or the changes in brightness are too small.
- Recording may start due to changes in brightness even if there is no movement within the red frame.
- While zooming, recording cannot be started.

## Remaining Recording Time/Battery Power

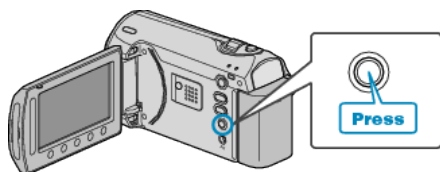

You can check the remaining video recording time on the built-in memory and SD card as well as the remaining battery power.

1 Press the  button.





2 Display the remaining recording time.



- The remaining recording time is displayed only in the video recording mode.
- Press the  button to check the remaining recording time of each recording media.
- While the remaining recording time is being displayed, touch the operation button "BATTERY ICON" to display the remaining battery power.
- To exit the display, touch the  button.

3 Display the remaining battery power.



- To exit the display, press the  button or touch the  button.
- Remaining battery power will not be displayed when the AC adapter is connected.

### Memo:

- You can change the video quality from the remaining recording time display. Select the video quality with the slider and touch .

## Approximate Video Recording Time

| Quality           | Built-In Memory (GZ-MS250) | Built-In Memory (GZ-MS230) | SDHC Card 4 GB | SDHC Card 8 GB | SDHC Card 16 GB | SDHC Card 32 GB |
|-------------------|----------------------------|----------------------------|----------------|----------------|-----------------|-----------------|
| <b>ULTRA FINE</b> | 7 h 30 m                   | 1 h 50 m                   | 56 m           | 1 h 50 m       | 3 h 45 m        | 7 h 30 m        |
| <b>FINE</b>       | 11 h 20 m                  | 2 h 45 m                   | 1 h 20 m       | 2 h 50 m       | 5 h 40 m        | 11 h 20 m       |
| <b>NORMAL</b>     | 15 h                       | 3 h 40 m                   | 1 h 45 m       | 3 h 45 m       | 7 h 30 m        | 15 h            |
| <b>ECONOMY</b>    | 40 h                       | 9 h 50 m                   | 4 h 57 m       | 10 h           | 20 h            | 40 h            |

- Built-in memory applies to GZ-MS230 only.
- The actual recording time may shorten depending on the shooting environment.

## Approximate Number of Still Images (Unit: Number of Shots)

| Switch             | Image Size     | Quality  | SD Card 256 MB | SD Card 512 MB | SD Card 1 GB | SD Card 2 GB |
|--------------------|----------------|----------|----------------|----------------|--------------|--------------|
| <b>Still Image</b> | 832x624 (4:3)  | FINE     | 970            | 1950           | 3950         | 7590         |
| <b>Still Image</b> | 832x624 (4:3)  | STANDARD | 1450           | 2930           | 5930         | 9999         |
| <b>Video</b>       | 640x480 (4:3)  | FINE     | 1450           | 2930           | 5930         | 9999         |
| <b>Video</b>       | 640x480 (4:3)  | STANDARD | 2080           | 4180           | 8480         | 9999         |
| <b>Video</b>       | 640x360 (16:9) | FINE     | 1820           | 3660           | 7420         | 9999         |
| <b>Video</b>       | 640x360 (16:9) | STANDARD | 2430           | 4880           | 9890         | 9999         |

- Up to 9999 still images may be recorded on the built-in memory and SD cards with at least 4 GB capacity (regardless of image size and quality).

## Approximate Recording Time (Using Battery)

| Battery Pack                | Actual Recording Time | Continuous Recording Time |
|-----------------------------|-----------------------|---------------------------|
| <b>BN-VG107U (Supplied)</b> | 50 m                  | 1 h 30 m                  |
| <b>BN-VG114U</b>            | 1 h 40 m              | 3 h 5 m                   |
| <b>BN-VG121U</b>            | 2 h 35 m              | 4 h 40 m                  |

- The above are values when "LIGHT" is set to "OFF" and "LCD BACK-LIGHT" is set to "STANDARD".
- The actual recording time may be shorter if zooming is used or if recording is stopped repeatedly.  
(It is recommended to prepare battery packs ready for three times the expected recording time.)

## Playing Back Videos

You can select and play back the recorded videos from an index screen (thumbnail display).

The contents of the saving destination selected in "REC MEDIA FOR VIDEO" are displayed on the index screen.

"REC MEDIA FOR VIDEO (GZ-MS230)" (P.95)

"VIDEO SLOT SELECTION (GZ-MS215)" (P.95)

1 Select the playback mode.

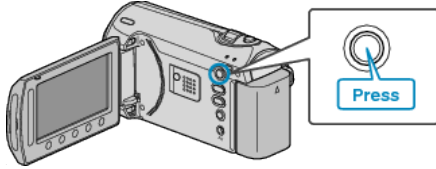

2 Select video mode.

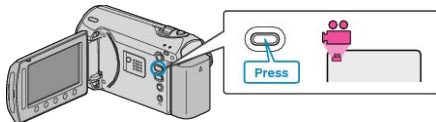

3 Select the desired video and touch OK.



• Touch ■ to stop playback.

### Operation Buttons for Video Playback

<During Index Screen Display>



<During Playback>



### During Index Screen Display

| Display | Description  |
|---------|--|
| ▶       | Starts playback of the selected file.  |
| DIGEST  | You can play back a digest of the recorded videos.                                       |
| 🔍       | You can search for a specific file by the recording date or registered category (event). |
| 🗑️      | Deletes the selected file.   |
| ▲/▼     | Press and hold to move the pages of the index screen.                                    |

### During Video Playback

| Display | Description                           |
|---------|---------------------------------------|
| ▶/⏸     | Playback/pause                        |
| ■       | Stop (returns to thumbnail display)   |
| ▶▶      | Advances to the next video            |
| ◀◀      | Returns to the beginning of the scene |
| ▶▶      | Forward search                        |
| ◀◀      | Reverse search                        |
| ▶       | Forward slow-motion                   |
| ◀       | Reverse slow-motion                   |

### Memo:

- Touch the slider and buttons around the screen with your fingers.
- The slider and buttons do not function if you touch them with your fingernails or with gloves on.
- The displays on the screen do not work even if you touch them.
- You can search for a specific file by the recording date or registered category (event).  
This is useful when searching from a large number of files.

"Group Search" (P.40)

"Date Search" (P.40)

"Event and Date Search" (P.41)

### CAUTION:

- Make a backup of important recorded data  
It is recommended to copy your important recorded data to a DVD or other recording media for storage. JVC will not be responsible for any lost data.

### Checking the Recording Date and Other Information

Press ⏻.

You can display the recording date of the selected file.

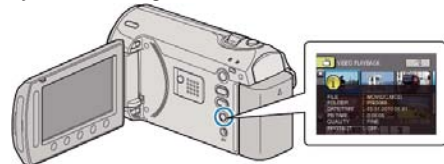

### Increasing/Decreasing the Number to Display on the Index Screen.

Operate the zoom lever when the index screen is displayed (thumbnail display) to change the number of files on the screen in the following order: 6 files → 20 files → 3 files.

- Information of the files also appear when 3 files are displayed.

## Checking the Content of Videos Quickly

You can play back a digest of the recorded videos (Digest Playback). This is useful for checking the content of the videos quickly.



- To start Digest Playback, touch the DIGEST button.

## Operation Buttons for Digest Playback



|  |                                       |
|--|---------------------------------------|
|  | Playback/pause                        |
|  | Stop (returns to thumbnail display)   |
|  | Returns to normal playback.           |
|  | Advances to the next video            |
|  | Returns to the beginning of the scene |
|  | Forward search                        |
|  | Reverse search                        |
|  | Forward slow-motion                   |
|  | Reverse slow-motion                   |

## Playing a Video with Defective Management Information

Plays videos with defective management information.

- 1 Select the playback mode.

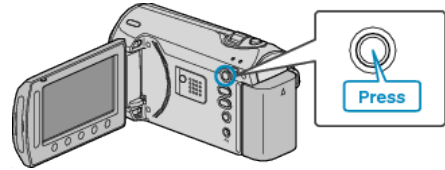

- 2 Select video mode.

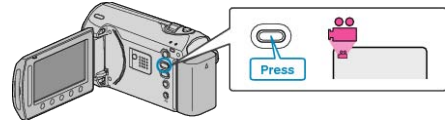

- 3 Touch to display the menu.

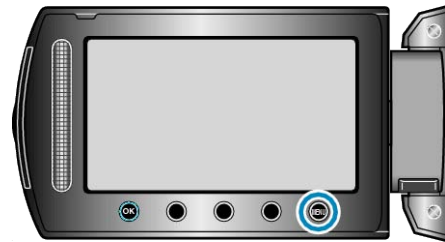

- 4 Select "PLAYBACK MPG FILE" and touch .



- 5 Select the desired video and touch .



"Playing Back Videos" ( P.37 )

## Playing Back Still Images

You can select and play back the recorded still images from an index screen (thumbnail display). The contents of the saving destination selected in "REC MEDIA FOR IMAGE" are displayed on the index screen. "REC MEDIA FOR IMAGE (GZ-MS230)" (P.96) "IMAGE SLOT SELECTION (GZ-MS215)" (P.96)

1 Select the playback mode.

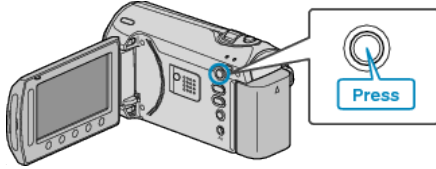

2 Select still image mode.

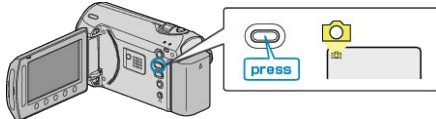

3 Select a still image and touch  $\odot$  to start playback.



• Touch  $\blacksquare$  to stop playback.

### Operation Buttons for Still Image Playback

<During Index Screen Display>

Select still image (Press and hold to move pages)



<During Playback>

Reverse Playback/Normal Playback (Displays either one during slideshow)

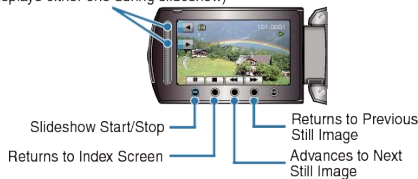

### During Index Screen Display

| Display                             | Description   |
|-------------------------------------|---|
| $\blacktriangleright$               | Starts playback of the selected file.                     |
| $\text{Q}$                          | You can search for a specific file by the recording date. |
| $\text{W}$                          | Deletes the selected file.                                |
| $\blacktriangle/\blacktriangledown$ | Press and hold to move the pages of the index screen.     |

### During Still Image Playback

| Display                                  | Description  |
|--|--|
| $\blacktriangleright/\text{II}$          | Start/pause slideshow                                    |
| $\blacksquare$                           | Stop (returns to thumbnail display)                      |
| $\blacktriangleright\blacktriangleright$ | Advances to the next still image                         |
| $\blacktriangleleft\blacktriangleleft$   | Returns to the previous still image                      |
| $\blacktriangleleft$                     | Plays back in reverse order during a slideshow.          |
| $\blacktriangleright$                    | Plays back in normal ascending order during a slideshow. |

#### Memo:

- Touch the slider and buttons around the screen with your fingers.
- The slider and buttons do not function if you touch them with your fingernails or with gloves on.
- The displays on the screen do not work even if you touch them.
- You can search for a specific file by the recording date. This is useful when searching from a large number of files.

"Date Search" (P.40)

### Checking the Recording Date and Other Information

Press  $\text{Q}$ .

You can display the recording date of the selected file.

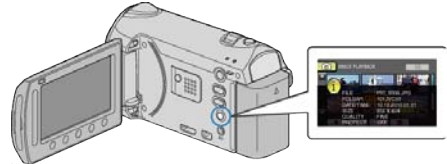

### Increasing/Decreasing the Number to Display on the Index Screen.

Operate the zoom lever when the index screen is displayed (thumbnail display) to change the number of files on the screen in the following order: 6 files  $\rightarrow$  20 files  $\rightarrow$  3 files.

- Information of the files also appear when 3 files are displayed.

### Slideshow Playback

Still images can be played back in a slideshow. Start the slideshow by pressing the  $\odot$  button during still image playback.



"Operation Buttons for Still Image Playback" (P.39)

#### Memo:

- Effects can be added to the transitions in slideshow playback.

"SLIDE SHOW EFFECTS" (P.86)

## Searching for a Specific Video/Still Image

When there is a large number of recorded videos and still images, it is difficult to look for the desired file from the index screen. Use the search function to find the file you want.

- For videos, you can search by "GROUP", "SEARCH DATE", or "SEARCH EVENT".
- For still images, you can search by "SEARCH DATE".

"To search by groups with similar recording dates" (P.40)

"To search by recording dates" (P.40)

"To search by events and recording dates" (P.41)

### Group Search

You can search and play videos which are automatically grouped according to similar recording dates.

- The contents of the saving destination selected in "REC MEDIA FOR VIDEO" are searched.

1 Display the search function.



- You can also display the search menu by selecting "SEARCH" on the playback menu.

2 Select "GROUP" and touch  $\odot$ .



3 Select from the index screen (thumbnails) and touch  $\odot$  to start playback.



- The video starts playing.
- Touch  $\blacksquare$  to stop playback.

### Memo:

- Touch "DIGEST" to play back a few seconds from each video, allowing you to check the contents of many videos in a short time.
- Groups are created automatically according to recording dates.
- The group may change when the recording is continued.

### Date Search

You can search and play videos or still images according to recording dates.

- The contents of the saving destination selected in "REC MEDIA FOR VIDEO" or "REC MEDIA FOR IMAGE" are searched.
- Still images can only be searched by "SEARCH DATE".

1 Display the search function.



- You can also display the search menu by selecting "SEARCH" on the playback menu. For still images, select "SEARCH DATE" on the menu.
- Searching can be performed in both the video and still image modes.  
\*The image shows the video mode.

2 Select "SEARCH DATE" and touch  $\odot$ .



3 Select a recording date and touch  $\odot$ .



4 Select the desired video or still image and touch  $\odot$  to start playback.



- You can select videos in the video mode and still images in the still image mode.
- Only the videos recorded on the selected date are displayed.

Deleting Files of a Selected Date :

Select "DELETE" from the playback menu to delete unwanted files.  
"Deleting Unwanted Files" (P.43)



## Event and Date Search

You can search and play videos according to events and recording dates.

- The contents of the saving destination selected in "REC MEDIA FOR VIDEO" are searched.
- Events that are not registered will not appear.

"Registering Files to Events Before Recording" (P.30)

1 Display the search function.



- Select search on the menu to display the search menu.

2 Select "SEARCH EVENT" and touch **OK**.



3 Select the event type and touch **OK**.



4 Select a recording date and touch **OK**.



- Only the videos recorded on the selected date are displayed.

5 Select the desired file and touch **OK** to start playback.



Deleting Files of a Selected Date : \_\_\_\_\_  
 Select "DELETE" from the playback menu to delete unwanted files.  
 "Deleting Unwanted Files" (P.43)

## Connecting to and Viewing on TV

By connecting the supplied AV cable to the video terminal, videos can be played back on a TV.

- Refer also to the instruction manual of the TV in use.

1 Connect to the TV.

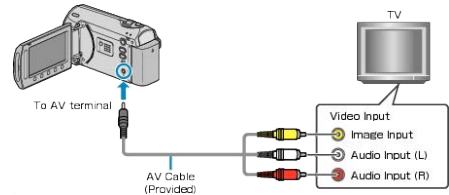

- Press and hold the power button for 2 seconds or more to turn off the power.

2 Connect the AC adapter to this unit.

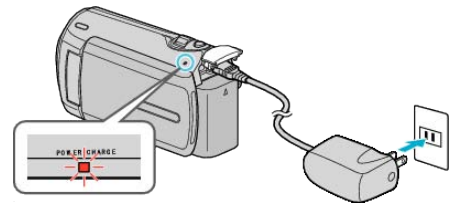

- Set "ON-SCREEN DISPLAY" in the menu to "DISPLAY ALL" or "DISPLAY DATE ONLY".

3 Press the external input button on the TV to switch to the input from this unit via the connected terminal.

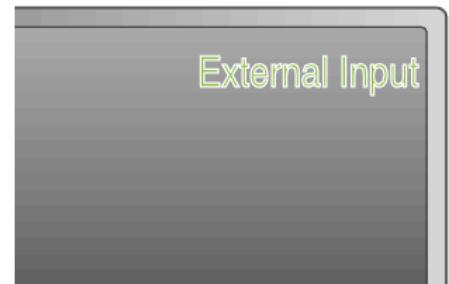

4 Play back a file.



"Playing Back Videos" (P.37)

"Playing Back Still Images" (P.39)

### Memo:

- To play back with date/time display, set "DISPLAY ON TV" in the connection settings menu to "ON". Set "ON-SCREEN DISPLAY" in the playback menu to "DISPLAY ALL" or "DISPLAY DATE ONLY".

"DISPLAY ON TV" (P.94)

"ON-SCREEN DISPLAY" (P.84)

- For questions about the TV or method of connection, contact your TV's manufacturer.

Unnatural Displays on TV

| Trouble                                      | Action  |
|--|---|
| Images do not appear on the TV properly.     | <ul style="list-style-type: none"> <li>• Disconnect the cable and connect again.</li> <li>• Turn off and on this unit again.</li> </ul> |
| Images are projected vertically on the TV.   | <ul style="list-style-type: none"> <li>• Set "VIDEO OUTPUT" in the connection settings menu to "4:3".</li> </ul> "VIDEO OUTPUT" (P.94)  |
| Images are projected horizontally on the TV. | <ul style="list-style-type: none"> <li>• Adjust the TV's screen accordingly.</li> </ul>   |

Playing Back Playlists

Play back the playlists that you have created.

1 Select the playback mode.

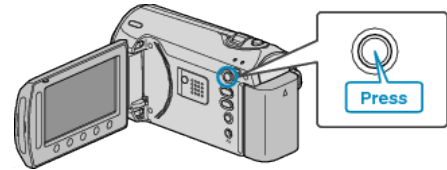

2 Select video mode.

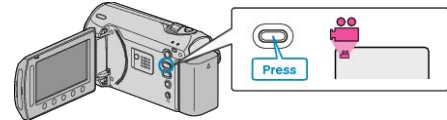

3 Touch to display the menu.

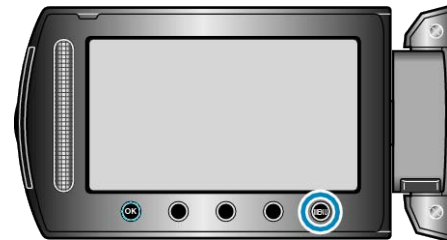

4 Select "PLAYBACK PLAYLIST" and touch .



5 Select the desired playlist and touch to start playback.



"Playing Back Videos" (P.37)

- Touch "CHECK" to check the content of the selected playlist.
- To exit the playback, touch .

Creating Playlists :

"Creating Playlists from the Recorded Videos" (P.53)

## Deleting Unwanted Files

Delete unwanted videos and still images when the space in the recording media is running out.

The capacity of the recording media can be restored after deleting the files.

"Deleting the Currently Displayed File" (P.43)

"Deleting Selected Files" (P.44)

"Deleting All Files" (P.45)

### Memo:

- Deleted files cannot be restored.
- When files in a playlist are deleted, the playlist changes.
- Files that are protected cannot be deleted.  
Release protection before deleting the file.

"Protecting Files" (P.45)

- Be sure to back up important files on a PC.

"Backing Up All Files" (P.65)

### Deleting the Currently Displayed File

Deletes the currently displayed file.

### CAUTION:

- Deleted files cannot be restored.

- 1 Select the playback mode.

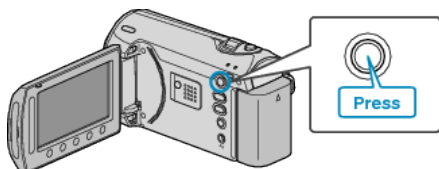

- 2 Select video or still image mode.

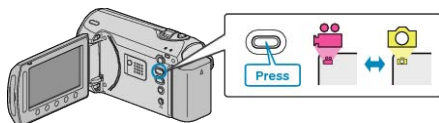

- 3 Touch  $\odot$  to display the menu.

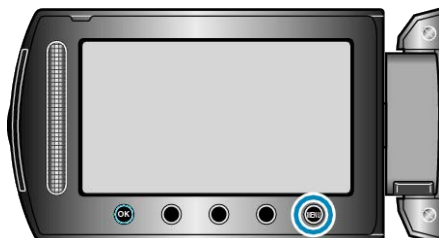

- 4 Select "DELETE" and touch  $\odot$ .



- 5 Select "CURRENT" and touch  $\odot$ .



- 6 Check that it is the file to delete, select "YES" and touch  $\odot$ .



- The file to delete appears on this screen.
- Touch the operation buttons " $\leftarrow$ " / " $\rightarrow$ " to select the previous or next file.
- After deleting, touch  $\odot$ .

### Memo:

- When files in a playlist are deleted, the playlist changes.
- Files that are protected cannot be deleted.  
Release protection before deleting the file.

"Protecting Files" (P.45)

## Deleting Selected Files

Deletes the selected files.

### CAUTION:

- Deleted files cannot be restored.

1 Select the playback mode.

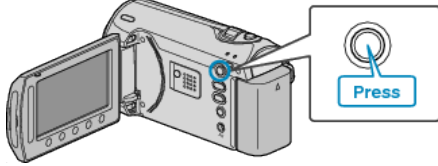

2 Select video or still image mode.

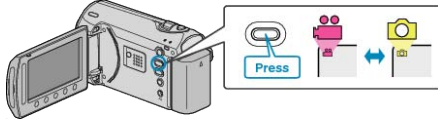

3 Touch **MENU** to display the menu.

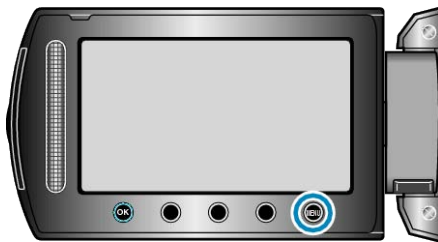

4 Select "DELETE" and touch **OK**.



5 Select "FILE SELECT" and touch **OK**.



6 Select the desired file and touch **OK**.



- A delete mark appears on the selected file. To remove the delete mark, touch **OK** again.
- Touch "CHECK" to check the selected file.

7 After selecting all the files to delete, touch "EXEC".



8 Select "YES" and touch **OK**.



- After deleting, touch **OK**.

### Memo:

- When files in a playlist are deleted, the playlist changes.
- Files that are protected cannot be deleted. Release protection before deleting the file.

"Protecting Files" (P.45)

## Deleting All Files

Deletes all files.

### CAUTION:

- Deleted files cannot be restored.

1 Select the playback mode.

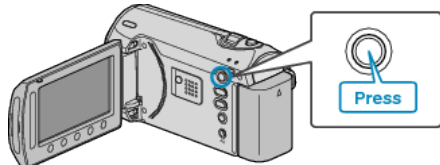

2 Select video or still image mode.

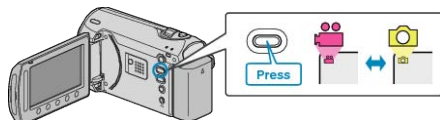

3 Touch **⊕** to display the menu.



4 Select "DELETE" and touch **⊕**.



5 Select "DELETE ALL" and touch **⊕**.



6 Select "YES" and touch **⊕**.



- After deleting, touch **⊕**.

### Memo:

- When files in a playlist are deleted, the playlist changes.
- Files that are protected cannot be deleted. Release protection before deleting the file.

"Protecting Files" (P.45)

## Protecting Files

Prevent important videos/still images from being deleted accidentally by protecting them.

"Protecting the Currently Displayed File" (P.45)

"Protecting Selected Files" (P.46)

"Protecting All Files" (P.47)

"Releasing Protection of All Files" (P.47)

### CAUTION:

- When the recording media is formatted, even the protected files will be deleted.

## Protecting the Currently Displayed File

Protects or releases protection of the currently displayed file.

1 Select the playback mode.

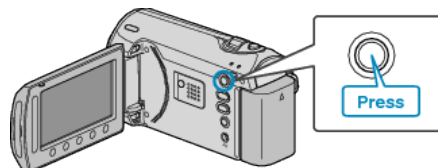

2 Select video or still image mode.



3 Touch **⊕** to display the menu.

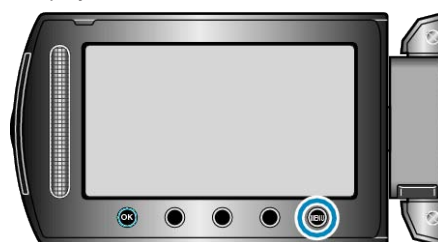

4 Select "EDIT" and touch **⊕**.



5 Select "PROTECT/CANCEL" and touch **⊕**.





6 Select "CURRENT" and touch **⊕**.



7 Check that it is the file to protect, select "YES" and touch .



- The file to protect appears on this screen.
- Touch the operation buttons "←" / "→" to select the previous or next file.
- After setting, touch .
- To exit the screen, touch .

## Protecting Selected Files

Protects or releases protection of the selected files.

1 Select the playback mode.

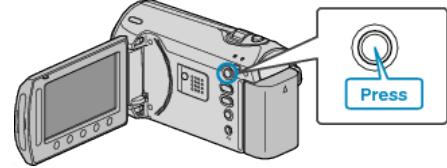

2 Select video or still image mode.

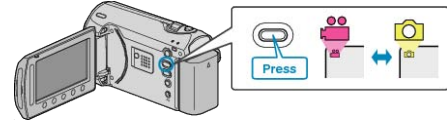

3 Touch  to display the menu.

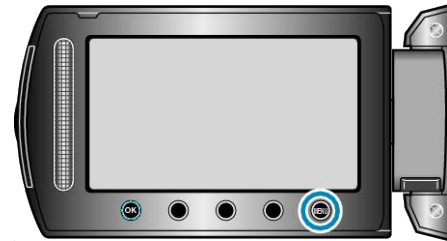

4 Select "EDIT" and touch .



5 Select "PROTECT/CANCEL" and touch .





6 Select "FILE SELECT" and touch .



7 Select the desired file and touch .



- A protect mark appears on the selected file.  
To remove the protect mark, touch  again.
  - Touch "CHECK" to check the selected file.
- 8 After selecting all the files to protect or release protection of, touch .

### Protecting All Files

Protects all files.

1 Select the playback mode.

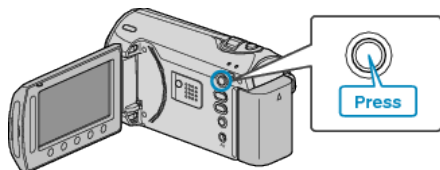

2 Select video or still image mode.

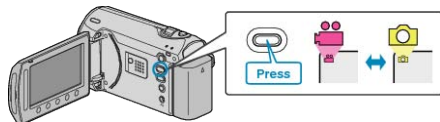

3 Touch **Ⓜ** to display the menu.

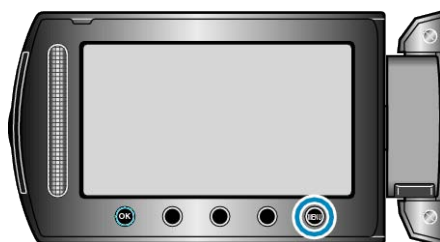

4 Select "EDIT" and touch **Ⓚ**.



5 Select "PROTECT/CANCEL" and touch **Ⓚ**.



6 Select "PROTECT ALL" and touch **Ⓚ**.



7 Select "YES" and touch **Ⓚ**.



• After setting, touch **Ⓚ**.

### Releasing Protection of All Files

Releases protection of all files.

1 Select the playback mode.

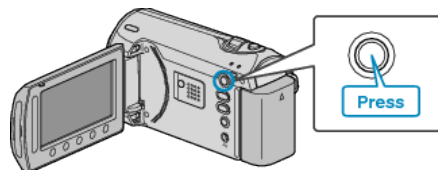

2 Select video or still image mode.

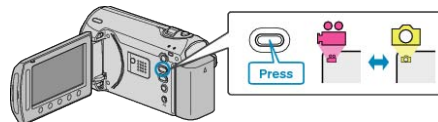

3 Touch **Ⓜ** to display the menu.

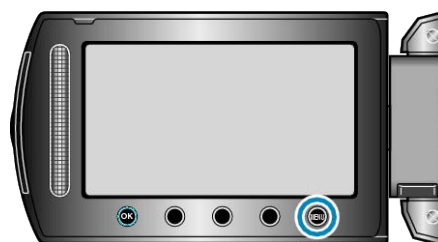

4 Select "EDIT" and touch **Ⓚ**.



5 Select "PROTECT/CANCEL" and touch **Ⓚ**.



6 Select "CANCEL ALL" and touch **Ⓚ**.



7 Select "YES" and touch **Ⓚ**.



• After setting, touch **Ⓚ**.

## Changing Event Registration of Videos

Find your recorded videos for playback easily by registering them to suitable items from the list of various events.

"Changing the Event of the Currently Displayed File" (P.48)

"Changing the Event of the Selected Files" (P.49)

**Memo:**

- You can also register files to events before recording if the content has been decided.

"Registering Files to Events Before Recording" (P.30)

### Changing the Event of the Currently Displayed File

Checks and changes the event of the currently displayed file.

- 1 Select the playback mode.

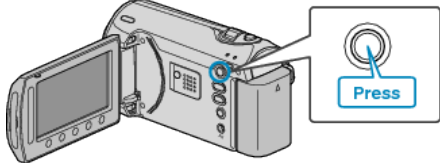

- 2 Select video mode.

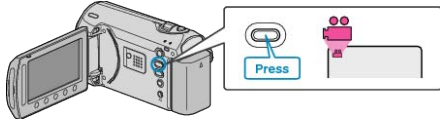

- 3 Touch **OK** to display the menu.

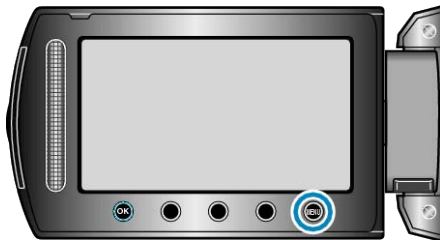

- 4 Select "EDIT" and touch **OK**.



- 5 Select "CHANGE EVENT REG." and touch **OK**.



- 6 Select "CURRENT" and touch **OK**.



- 7 Select "YES" and touch **OK**.



- Touch the operation buttons "←" / "→" to select the previous or next file.

- 8 Select a new event and touch **OK**.



- You can cancel the registered event by touching "CANCEL".
- After setting, touch **OK**.
- To exit the screen, touch **OK**.



### Changing the Event of the Selected Files

Changes the event of multiple files by specifying a range.

1 Select the playback mode.

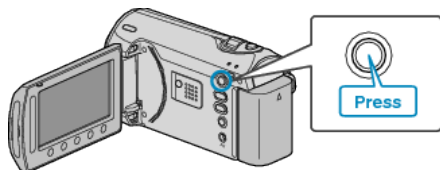

2 Select video mode.

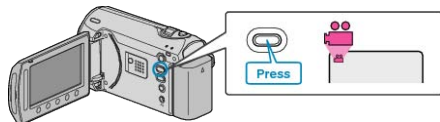

3 Touch **MENU** to display the menu.

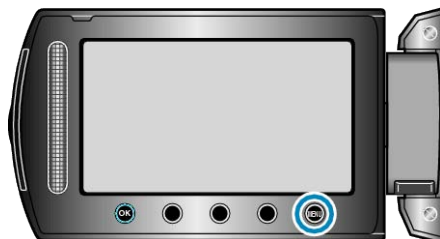

4 Select "EDIT" and touch **OK**.



5 Select "CHANGE EVENT REG." and touch **OK**.



6 Select "TO RESET RANGE" and touch **OK**.



7 Select the first file of the range and touch **OK**.



- Touch "CHECK" to check the selected file.

8 Select the last file of the range and touch **OK**.



9 Select a new event and touch **OK**.



- You can cancel the registered event by touching "CANCEL".
- After setting, touch **OK**.
- To exit the screen, touch **MENU**.

## Capturing a Still Image in the Video during Playback

You can capture still images of the scenes you like in the recorded videos.

1 Select the playback mode.

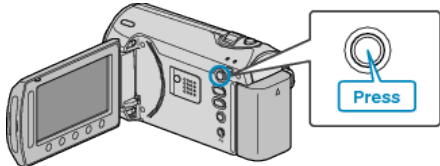

2 Select video mode.

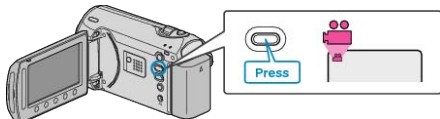

3 Select the desired video and touch OK.



4 Touch pause at the desired scene during playback.



- After pausing the video, you can fine-tune the point to capture by using the forward slow-motion and reverse slow-motion operation buttons.

5 Capture a still image.

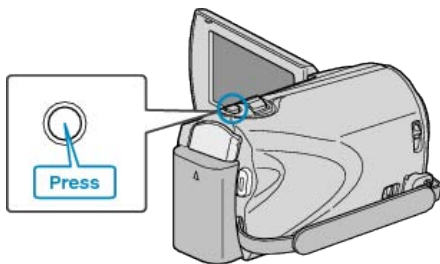

**Memo:**

- The size of the still images captured varies with the "SELECT ASPECT RATIO" setting.  
 "16:9" : 640x360  
 "4:3" : 640x480
- The picture quality varies with the "IMAGE QUALITY" setting.  
 "IMAGE QUALITY" (P.79)
- Captured still images are stored in the media specified in "REC MEDIA FOR IMAGE".  
 "REC MEDIA FOR IMAGE (GZ-MS230)" (P.96)  
 "IMAGE SLOT SELECTION (GZ-MS215)" (P.96)

## Capturing a Required Part in the Video

Select the required part of a video and save it as a new video file.

1 Select the playback mode.

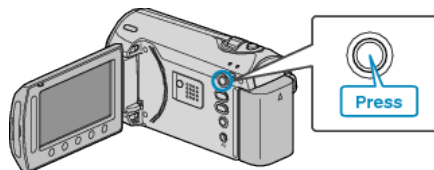

2 Select video mode.

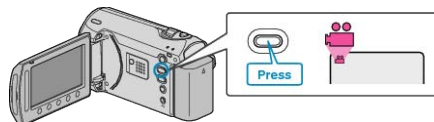

3 Touch to display the menu.

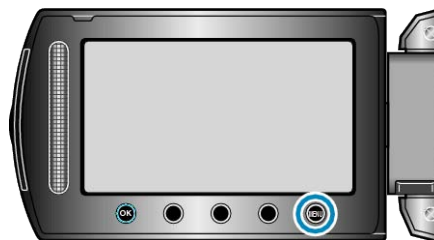

4 Select "EDIT" and touch OK.



5 Select "TRIMMING" and touch OK.



6 Select the desired video and touch OK.



- Playback of the selected video starts.

7 Touch to pause playback, then touch SET to set the start point.



- Touch **OK** to resume playback.  
"Playing Back Videos" (P.37)

- 8 Touch **OK** to pause playback, then touch SET to set the point to stop copying.



- To reset the start point, touch CANCEL.
- 9 Select "CAPTURE TRIMMED FILE" and touch **OK**.



- 10 Select "YES" and touch **OK**.



- After copying, touch **OK**.
- When copying finishes, the copied file is added to the index screen.
- To exit the screen, touch **MEMO**.

**Memo:**

- According to the MPEG-2 standard, videos are split into units of approximately 0.5 second.  
As such, the division point may not be accurate.

## Capturing Videos for Uploading to YouTube

Capture and copy a part of a recorded video (maximum 10 minutes) for uploading to YouTube, and save it as a YouTube video. When capturing videos for YouTube, the duration cannot be longer than 10 minutes.

- 1 Select the playback mode.

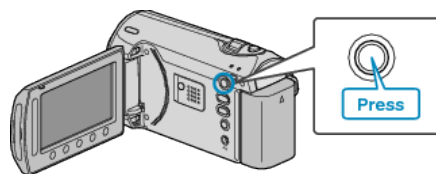

- 2 Select video mode.

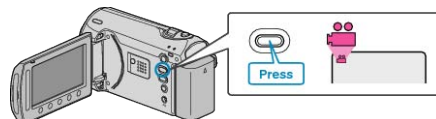

- 3 Press the UPLOAD/EXPORT button to display the UPLOAD SETTINGS/EXPORT SETTINGS menu.

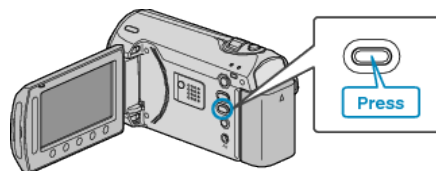

- 4 Select "UPLOAD SETTINGS" and touch **OK**.



- 5 Select the desired video and touch **OK**.



- 6 (When the selected video is less than 10 minutes) Select whether to perform trimming.



- When trimming is not necessary, select "DO NOT TRIM" and touch **OK** to complete the setting.
  - If the selected video is more than 10 minutes, trimming is necessary.
- 7 Touch **OK** to pause playback, then touch SET to set the start point.



- Resume playback after setting the start point.  
"Playing Back Videos" (P.37)

8 Touch **OK** to pause playback, then touch SET to set the point to stop copying.



- To reset the start point, touch "CANCEL".
- When capturing videos for YouTube, the duration cannot be longer than 10 minutes.

9 Select "CAPTURE TRIMMED FILE" and touch **OK**.



10 Select "YES" and touch **OK**.



- When copying finishes, the copied file is added to the index screen.
- To exit the screen, touch **MENU**.

**Memo:**

- According to the MPEG-2 standard, videos are split into units of approximately 0.5 second. As such, the division point may not be accurate.
- You can take videos in YouTube format by setting upload shooting before recording.

"Taking Videos in YouTube Format" (P.31)

**Uploading Videos to YouTube**

You can upload your videos to YouTube using the provided software "Everio MediaBrowser". Install the software on your PC and connect this unit to the PC.

- For details on how to use the software, refer to the help file.

"Installing the Provided Software" (P.64)

"Copying to Windows PC" (P.64)

Trouble with Uploading Videos :

- Check if you have created an account with YouTube. (You need a YouTube account to upload files to YouTube.)
- Refer to "Q&A", "Latest Information", "Download Information", etc. in "Click for Latest Product Info" in the help file of the provided software "Everio MediaBrowser".

**Preparing Videos to Transfer to iTunes**

Set EXPORT attributes to the recorded videos by adding a "LIB." mark. When EXPORT attributes are set, the videos can be registered to iTunes easily using the supplied software on a PC.

1 Select the playback mode.

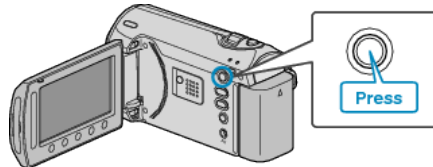

2 Select video mode.



3 Press the UPLOAD/EXPORT button to display the UPLOAD SETTINGS/EXPORT SETTINGS menu.

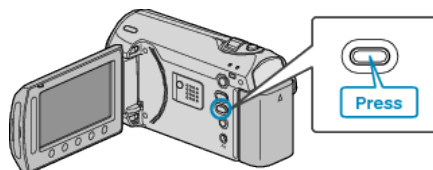

4 Select "EXPORT SETTINGS" and touch **OK**.



5 Select the desired video and touch **OK**.



- A "LIB." mark appears on the selected file. To remove the "LIB." mark, touch **OK** again.
- Touch "CHECK" to check the selected file.
- To exit EXPORT SETTINGS, touch **MENU**.

**Memo:**

- You can take videos in iTunes format by setting EXPORT shooting before recording.
- "Taking Videos in iTunes Format" (P.32)
- The format of recorded videos changes when they are transferred to a PC using the supplied software. Files that are stored on this unit will not be affected.
- The "LIB." mark does not appear on other index screens.

**Transferring Converted Videos to iPod**

You can export videos to iTunes using the provided software "Everio MediaBrowser". Install the software on your PC and connect this unit to the PC.

- For details on how to use the software, refer to the help file.
- For details on transferring files to iPod, refer to the help file of iTunes.

"Installing the Provided Software" (P.64)

"Backing Up All Files" (P.65)

Trouble with Exporting Files to iTunes :

- Refer to "Q&A", "Latest Information", "Download Information", etc. in "Click for Latest Product Info" in the help file of the provided software "Everio MediaBrowser".

## Creating Playlists from the Recorded Videos

A list created by selecting your favorite videos from the recorded ones is called a playlist.

By creating a playlist, you can play back only your favorite videos in the order you like.

The original video file remains even when it is registered to a playlist.

- To create a new playlist

"Creating Playlists with Selected Files" (P.53)

"Creating Playlists by Group" (P.54)

"Creating Playlists by Date" (P.55)

"Creating Playlists by Event" (P.56)

- To edit or delete a created playlist

"Editing Playlists" (P.57)

"Deleting Playlists" (P.58)

### Memo:

- When a video file is deleted or moved, the same file will be removed from the playlist.

## Creating Playlists with Selected Files

Create a playlist by arranging the files one by one.

- 1 Select the playback mode.

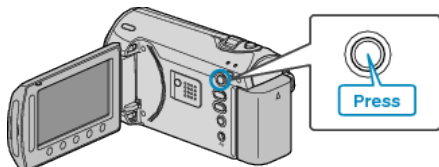

- 2 Select video mode.

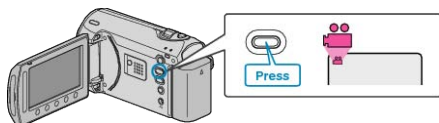

- 3 Touch **MENU** to display the menu.

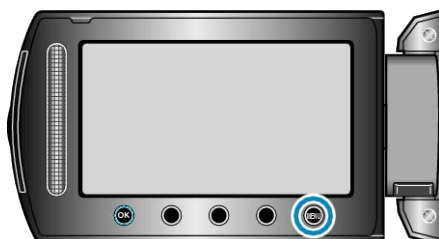

- 4 Select "EDIT PLAYLIST" and touch **OK**.



- 5 Select "NEW LIST" and touch **OK**.



- 6 Select "CREATE FROM SCENE" and touch **OK**.



- 7 Select the file to add to playlist and touch **OK**.



- Touch "CHECK" to check the selected video.

- 8 Select the insertion point and touch **OK**.



- The selected videos are added to the playlist on the right.
- To delete a video from the playlist, touch "→" to select the video and touch **OK**.
- Repeat steps 7-8 and arrange the videos in the playlist.

- 9 After arranging, touch **MENU**.



- 10 Select "SAVE AND THEN QUIT" and touch **OK**.



### Creating Playlists by Group

Create a playlist by arranging multiple files according to group.

1 Select the playback mode.

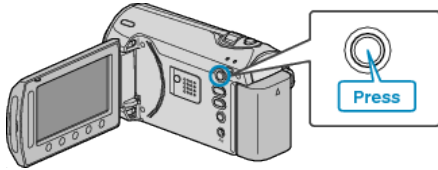

2 Select video mode.

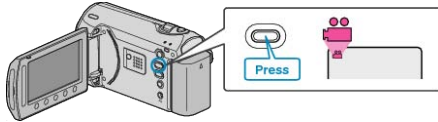

3 Touch **Ⓜ** to display the menu.

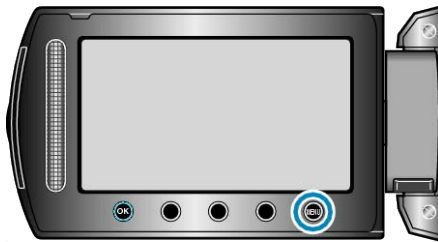

4 Select "EDIT PLAYLIST" and touch **Ⓚ**.



5 Select "NEW LIST" and touch **Ⓚ**.



6 Select "CREATE BY GROUP" and touch **Ⓚ**.



7 Select the group to add to playlist and touch **Ⓚ**.



- Touch "CHECK" to check the selected video.

8 Select the insertion point and touch **Ⓚ**.



- The selected videos are added to the playlist on the right.
- To delete a video from the playlist, touch "→" to select the video and touch **Ⓚ**.
- Repeat steps 7-8 and arrange the videos in the playlist.

9 After arranging, touch **Ⓜ**.



10 Select "SAVE AND THEN QUIT" and touch **Ⓚ**.



### Creating Playlists by Date

Create a playlist by arranging multiple files according to recording date.

1 Select the playback mode.

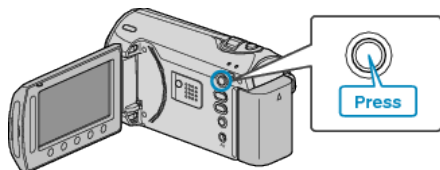

2 Select video mode.

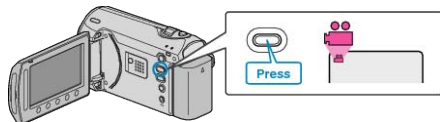

3 Touch **MENU** to display the menu.

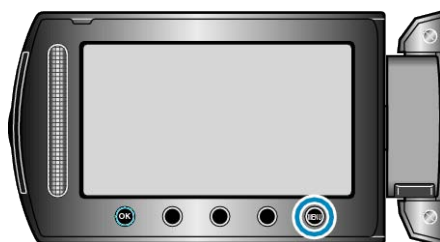

4 Select "EDIT PLAYLIST" and touch **OK**.



5 Select "NEW LIST" and touch **OK**.



6 Select "CREATE BY DATE" and touch **OK**.



7 Select the date to add to playlist and touch **OK**.



- Touch "CHECK" to check the selected video.

8 Select the insertion point and touch **OK**.



- The selected videos are added to the playlist on the right.
- To delete a video from the playlist, touch "→" to select the video and touch **OK**.
- Repeat steps 7-8 and arrange the videos in the playlist.

9 After arranging, touch **MENU**.



10 Select "SAVE AND THEN QUIT" and touch **OK**.



### Creating Playlists by Event

Create a playlist by arranging multiple files according to events and recording dates.

1 Select the playback mode.

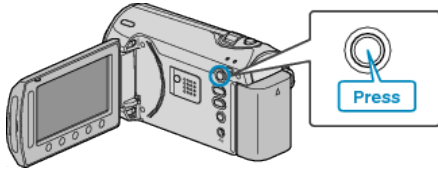

2 Select video mode.

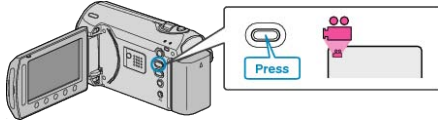

3 Touch **MENU** to display the menu.

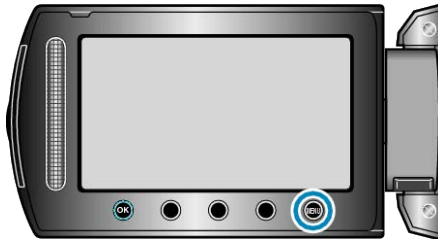

4 Select "EDIT PLAYLIST" and touch **OK**.



5 Select "NEW LIST" and touch **OK**.



6 Select "CREATE BY EVENT" and touch **OK**.



7 Select an event and touch **OK**.



8 Select the date to add to playlist and touch **OK**.



- Touch "CHECK" to check the selected video.

9 Select the insertion point and touch **OK**.



- The selected videos are added to the playlist on the right.
- To delete a video from the playlist, touch "→" to select the video and touch **OK**.
- Repeat steps 8-9 and arrange the videos in the playlist.

10 After arranging, touch **MENU**.



11 Select "SAVE AND THEN QUIT" and touch **OK**.





## Editing Playlists

You can change the content of a created playlist.

1 Select the playback mode.

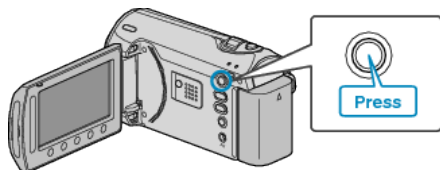

2 Select video mode.

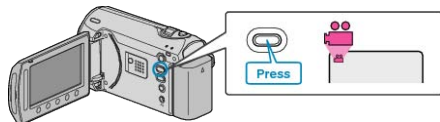

3 Touch **MENU** to display the menu.

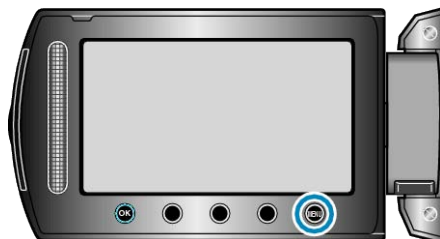

4 Select "EDIT PLAYLIST" and touch **OK**.



5 Select "EDIT" and touch **OK**.



6 Select the playlist you want to edit and touch **OK**.



7 Select the file to add to playlist and touch **OK**.



- Touch "CHECK" to check the selected video.

8 Select the insertion point and touch **OK**.



- The selected videos are added to the playlist on the right.
- To delete a video from the playlist, touch "→" to select the video and touch **OK**.
- Repeat steps 7-8 and arrange the videos in the playlist.

9 After arranging, touch **MENU**.



10 Select "SAVE AND THEN QUIT" and touch **OK**.



## Deleting Playlists

Delete the playlists that you have created.

1 Select the playback mode.

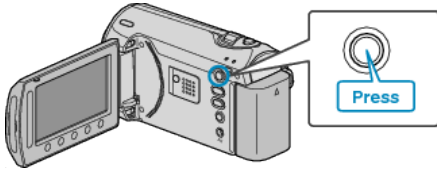

2 Select video mode.

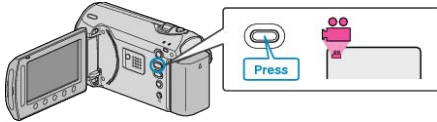

3 Touch  to display the menu.

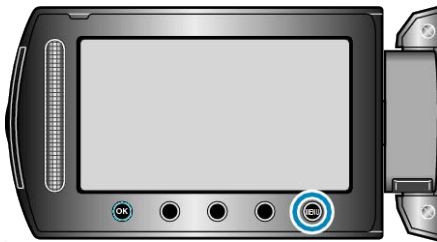

4 Select "EDIT PLAYLIST" and touch .



5 Select "DELETE" and touch .



6 Select the playlist you want to delete and touch .



• All created playlists will be deleted when "DELETE ALL" is selected.

7 Select "YES" and touch .



- After deleting is complete, the screen returns to the delete playlist selection screen.
- After deleting, touch .

## Copying Files to Card

You can copy videos and still images to another SD card.  
 "Copying All Files" (P.59)  
 "Copying Selected Files" (P.60)

### Copying All Files

Copies all videos and still images to another media.

1 Select the playback mode.

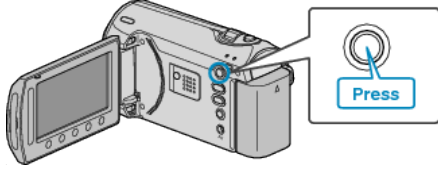

2 Select video or still image mode.

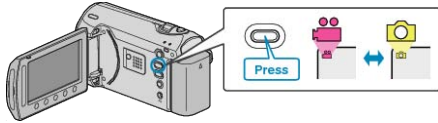

3 Touch **OK** to display the menu.

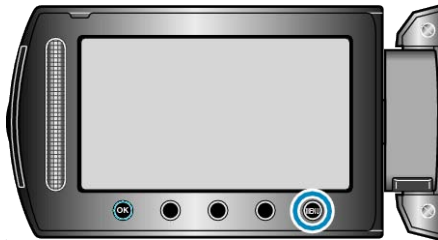

4 Select "EDIT" and touch **OK**.



5 Select "COPY" and touch **OK**.



6 Select the direction of copying and touch **OK**.



(GZ-MS230)



(GZ-MS215)

- The direction of copying varies with the model.

7 Select "COPY ALL" and touch **OK**.



8 Select "YES" and touch **OK**.



- Copying starts.
- After copying, touch **OK**.

## Copying Selected Files

Copies selected videos and still images to another media.

1 Select the playback mode.

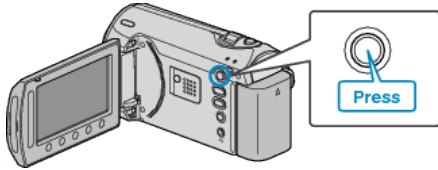

2 Select video or still image mode.

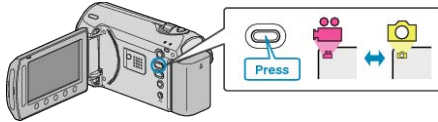

3 Touch **Ⓜ** to display the menu.

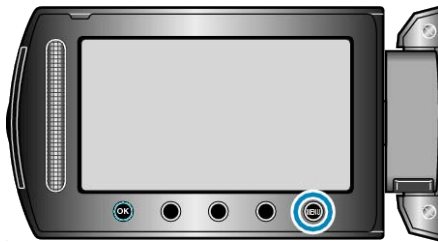

4 Select "EDIT" and touch **Ⓚ**.



5 Select "COPY" and touch **Ⓚ**.



6 Select the direction of copying and touch **Ⓚ**.



(GZ-MS230)



(GZ-MS215)

• The direction of copying varies with the model.

7 Select "SELECT AND COPY" and touch **Ⓚ**.



8 Select the desired file and touch **Ⓚ**.



• A check mark appears on the selected file.  
To remove the check mark, touch **Ⓚ** again.

9 After selecting all the files to copy, touch "EXEC".



10 Select "YES" and touch **Ⓚ**.



• Copying starts.  
• After copying, touch **Ⓚ**.

## Moving Files

You can move videos and still images to another SD card. Files that are moved will be deleted from the original media. Moving still images to SD cards makes it convenient to bring them to the shop for printing (developing).  
 "Moving All Files" (P.61)  
 "Moving Selected Files" (P.62)

### Moving All Files

Moves all videos and still images to another media. Files that are moved will be deleted from the original media. Files with a protect mark will not be deleted from the original media.

1 Select the playback mode.

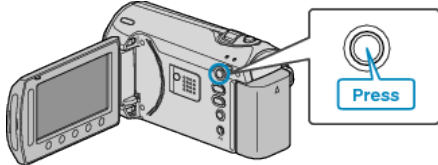

2 Select video or still image mode.

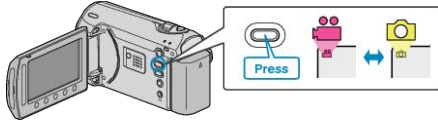

3 Touch **OK** to display the menu.

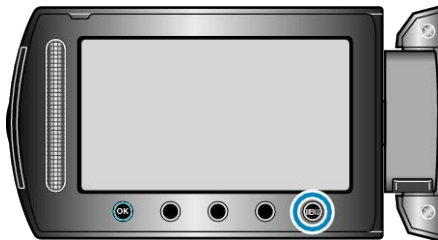

4 Select "EDIT" and touch **OK**.



5 Select "MOVE" and touch **OK**.



6 Select the direction of moving and touch **OK**.



(GZ-MS230)



(GZ-MS215)

- The direction of moving varies with the model.

7 Select "MOVE ALL" and touch **OK**.



8 Select "YES" and touch **OK**.



- Moving of files starts.
- After moving, touch **OK**.

## Moving Selected Files

Moves selected videos and still images to another media. Files that are moved will be deleted from the original media.

1 Select the playback mode.

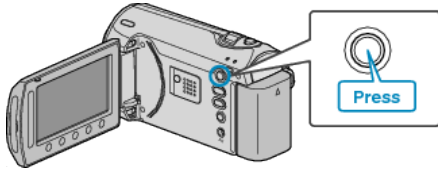

2 Select video or still image mode.

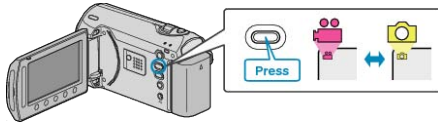

3 Touch **MENU** to display the menu.

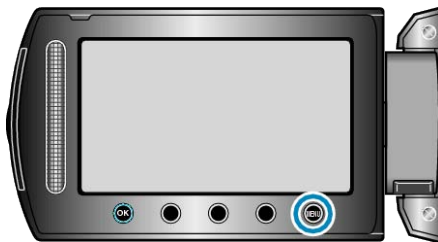

4 Select "EDIT" and touch **OK**.



5 Select "MOVE" and touch **OK**.



6 Select the direction of moving and touch **OK**.



(GZ-MS230)



(GZ-MS215)

• The direction of moving varies with the model.

7 Select "SELECT AND MOVE" and touch **OK**.



8 Select the desired file and touch **OK**.



• A check mark appears on the selected file.  
To remove the check mark, touch **OK** again.

9 After selecting all the files to move, touch EXEC.



10 Select "YES" and touch **OK**.



• Moving of files starts.  
• After moving, touch **OK**.

## Dubbing Files to a DVD Recorder or VCR

You can dub videos by connecting to a DVD recorder or VCR.

- Refer also to the instruction manuals of the TV, DVD recorder, VCR, etc.

### 1 Connect to a VCR/DVD recorder.

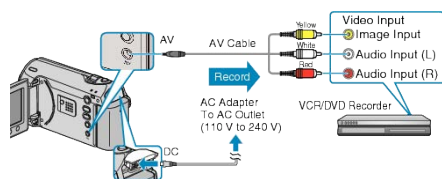

- Press and hold the power button for 2 seconds or more to turn off the power.

### 2 Select the playback mode.

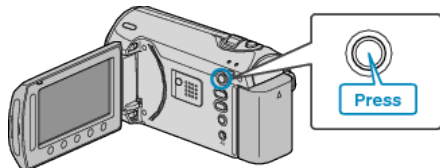

### 3 Prepare the TV/VCR for recording.

- Switch to a compatible external input.
- Insert a DVD-R or video tape.

### 4 Prepare this unit for playback.

- Set "VIDEO OUTPUT" in the connection settings menu to the aspect ratio (4:3 or 16:9) of the connecting TV.

"VIDEO OUTPUT" (P.94)

- To include the date during dubbing, set "DISPLAY ON TV" in the connection settings menu to "ON".

Set "ON-SCREEN DISPLAY" in the playback menu to "DISPLAY DATE ONLY".

"DISPLAY ON TV" (P.94)

"ON-SCREEN DISPLAY" (P.84)

### 5 Start recording.

- Start playback on this unit and press the record button on the VCR/DVD recorder.

"Playing Back Videos" (P.37)

- After playback is complete, stop the recording.

#### Memo:

- When there are many videos to dub, you can create a playlist in advance and play it back so that all your favorite videos can be dubbed at once.

"Creating Playlists with Selected Files" (P.53)

"Playing Back Playlists" (P.42)

#### CAUTION:

- Dubbing cannot be performed by connecting this unit to a Blu-ray recorder with a USB cable.  
Connect and dub using the supplied AV cable.

## Copying to Windows PC

You can copy files to a PC using the provided software.

DVDs can also be created using the PC's DVD drive.

If the provided software is not installed, this unit will be recognized as an external storage when connected.

**Memo:**

- To record to discs, a recordable DVD drive is required for the PC in use.
- Still images cannot be recorded to discs using the provided software.

### Trouble with Using the Provided Software Everio MediaBrowser

Consult the customer service center below.

- Pixela User Support Center

|                  |  |
|------------------|--|
| <b>Telephone</b> | USA and Canada (English): +1-800-458-4029 (toll-free)<br>Europe (UK, Germany, France, and Spain)<br>(English/German/French/Spanish): +800-1532-4865 (toll-free)<br>Other Countries in Europe<br>(English/German/French/Spanish): +44-1489-564-764<br>Asia (Philippines) (English): +63-2-438-0090<br>China (Chinese): 10800-163-0014 (toll-free) |
| <b>Homepage</b>  | <a href="http://www.pixela.co.jp/oem/jvc/mediabrowser/e/">http://www.pixela.co.jp/oem/jvc/mediabrowser/e/</a>  |

- For details on how to upload to Youtube or transfer files to iTunes, refer to "MediaBrowser Help" in the "Help" menu of Everio MediaBrowser.

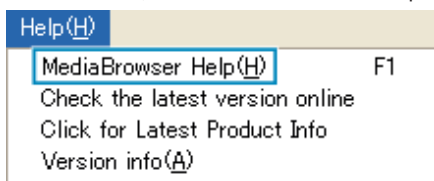

### Verifying System Requirements (Guideline)

Right-click on "Computer" (or "My Computer") in the "Start" menu and select "Properties" to check the following items.

#### Windows Vista/Windows 7

- Refer to the operating instructions found in the animation on the Detailed User Guide.

#### Windows XP

- Refer to the operating instructions found in the animation on the Detailed User Guide.

|     | Windows Vista/Windows 7  | Windows XP   |
|-----|--|--|
| OS  | Windows Vista<br>Home Basic or Home Premium<br>(Pre-installed versions only)Windows 7<br>Home Premium(Pre-installed versions on-ly)<br>Service Pack 2<br>32/64-bit | Windows XP<br>Home Edition or Professional<br>(Pre-installed versions only)Service Pack 3                              |
| CPU | Intel Core Duo CPU 1.5 GHz or higher<br>Intel Pentium 4 CPU 1.6 GHz or higher<br>Intel Pentium M CPU 1.4 GHz or higher   | Intel Core Duo CPU 1.5 GHz or higher<br>Intel Pentium 4 CPU 1.6 GHz or higher<br>Intel Pentium M CPU 1.4 GHz or higher |
| RAM | At least 1 GB (1024 MB)  | At least 512 MB  |

**Memo:**

- If your PC does not meet the above system requirements, operations of the provided software cannot be guaranteed.
- For more information, contact your PC's manufacturer.

### Installing the Provided Software

You can display the recorded images in calendar format and perform simple editing using the provided software.

#### Windows Vista / Windows 7

- Refer to the operating instructions found in the animation on the Detailed User Guide.

#### Windows XP

- Refer to the operating instructions found in the animation on the Detailed User Guide.



### Backing Up All Files

Before making backup, make sure that enough free space is left in the PC's hard disk (HDD).

1 Connect the USB cable and the AC adapter.

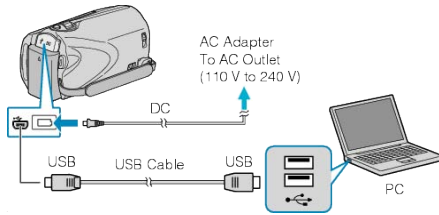

- ① Connect the AC adapter to this unit.
- ② Connect using the provided USB cable.

2 Open the LCD monitor.

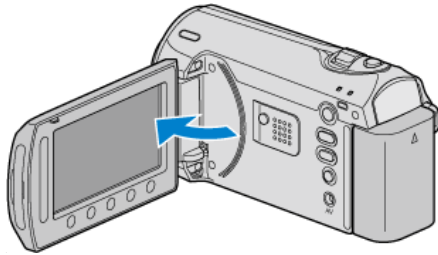

- The USB MENU appears.

3 Select "BACK UP" and touch **OK**.



- The provided software Everio MediaBrowser starts up on the PC. The subsequent operations are to be performed on the PC.

4 Select the volume.



Click "All volume in camcorder"

5 Start backup.

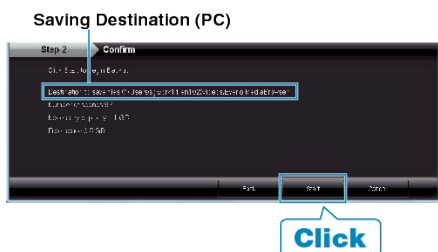

- Backup starts.

6 After backup is complete, click "OK".



#### Memo:

- Before making backup, load the SD card in which the videos and still images are stored on this unit.
- If you encounter any problems with the provided software Everio MediaBrowser, please consult the "Pixela User Support Center".

|                  |  |
|------------------|--|
| <b>Telephone</b> | USA and Canada (English): +1-800-458-4029 (toll-free)<br>Europe (UK, Germany, France, and Spain) (English/German/French/Spanish): +800-1532-4865 (toll-free)<br>Other Countries in Europe (English/German/French/Spanish): +44-1489-564-764<br>Asia (Philippines) (English): +63-2-438-0090<br>China (Chinese): 10800-163-0014 (toll-free) |
| <b>Home-page</b> | <a href="http://www.pixela.co.jp/oem/jvc/mediabrowser/e/">http://www.pixela.co.jp/oem/jvc/mediabrowser/e/</a>  |

- Delete unwanted videos before making backup. It takes time to back up many videos.

"Deleting Unwanted Files" (P.43)

### Disconnecting this Unit from PC

1 Click "Safely Remove Hardware".



2 Click "Safely Remove USB Mass Storage Device".

3 (For Windows Vista) Click "OK".

4 Disconnect the USB cable and close the LCD monitor.

## Organizing Files

After backing up your files, organize them by adding labels such as "Family Trip" or "Athletic Meet". This is useful not only for creating discs, but for viewing the files too.

1 Display the month of the files to organize.



2 Create a user list.



• A new user list is added to the user list library.

3 Click on the recording day.

• The thumbnails of the files recorded on the day are displayed.

4 Register files to the created user list.

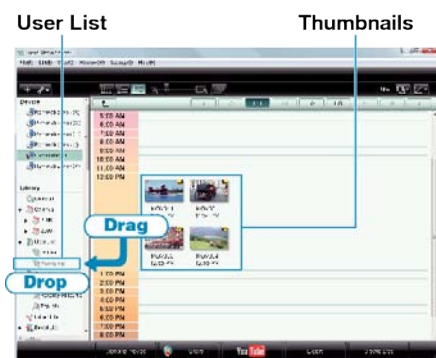

Identifying Video or Still Image : \_\_\_\_\_

- You can select files using the "SELECT" menu on the top right of the screen.
- Check the video/still image icon on the top right corner of the thumbnail.

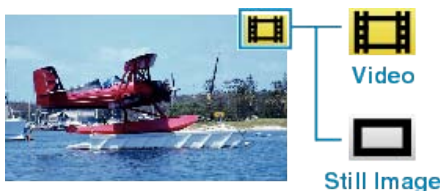

Memo: \_\_\_\_\_

- If you encounter any problems with the provided software Everio MediaBrowser, please consult the "Pixela User Support Center".

|                  |  |
|------------------|--|
| <b>Telephone</b> | USA and Canada (English): +1-800-458-4029 (toll-free)<br>Europe (UK, Germany, France, and Spain)<br>(English/German/French/Spanish): +800-1532-4865 (toll-free)<br>Other Countries in Europe<br>(English/German/French/Spanish): +44-1489-564-764<br>Asia (Philippines) (English): +63-2-438-0090<br>China (Chinese): 10800-163-0014 (toll-free) |
| <b>Homepage</b>  | <a href="http://www.pixela.co.jp/oem/jvc/mediabrowser/e/">http://www.pixela.co.jp/oem/jvc/mediabrowser/e/</a>  |

## Recording Videos to Discs

Copy the files that are arranged using the user list to DVDs.

- 1 Insert a new disc into the PC's recordable DVD drive.
- 2 Select the desired user list.

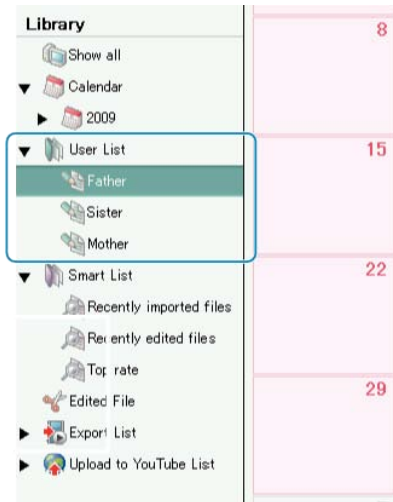

- 3 Select the method of file selection.



- If you select "Select all files displayed", only the displayed videos are copied to the DVD. Proceed to step 5.
  - If you select "Select files individually", proceed to step 4.
- 4 (When "Select files individually" is selected) Select the files to copy to DVD in order.



- After selecting, click "NEXT".

- 5 Set the top menu of the disc.



- Set the title and menu background.

- 6 Copying to disc starts.



- After copying, click "OK".

**Memo:** \_\_\_\_\_

- The following types of discs can be used on the provided software Everio MediaBrowser.
  - DVD-R
  - DVD-R DL
  - DVD-RW
  - DVD+R
  - DVD+R DL
  - DVD+RW
- To view the help file of Everio MediaBrowser, select "Help" from the Everio MediaBrowser's menu bar or press F1 on the keyboard.
- If you encounter any problems with the provided software Everio MediaBrowser, please consult the "Pixela User Support Center".

|                        |  |
|------------------------|--|
| <b>Tele-<br/>phone</b> | USA and Canada (English): +1-800-458-4029 (toll-free)<br>Europe (UK, Germany, France, and Spain)<br>(English/German/French/Spanish): +800-1532-4865 (toll-free)<br>Other Countries in Europe<br>(English/German/French/Spanish): +44-1489-564-764<br>Asia (Philippines) (English): +63-2-438-0090<br>China (Chinese): 10800-163-0014 (toll-free) |
| <b>Home-<br/>page</b>  | <a href="http://www.pixela.co.jp/oem/jvc/mediabrowser/e/">http://www.pixela.co.jp/oem/jvc/mediabrowser/e/</a>  |

**JVC Software Licence Agreement**

**IMPORTANT**

TO CUSTOMERS: PLEASE MAKE SURE TO READ THIS CAREFULLY BEFORE INSTALLING OR USING THE SOFTWARE PROGRAM NAMED "DIGITAL PHOTO NAVIGATOR" ("Program") ON YOUR PC. The right to use the Program is granted by Victor Company of Japan, Limited ("JVC") to You only on the condition that You agree to the following.

Should You not agree to the terms hereof, You may not install or use the Program. HOWEVER, INSTALLING OR USING THE PROGRAM INDICATES YOUR ACCEPTANCE OF THESE TERMS AND CONDITIONS.

**1 COPYRIGHT; OWNERSHIP**

You acknowledge that all copyrights and other intellectual property rights in the Program are owned by JVC and its licensor, and remain vested in JVC and such licensor. The Program is protected under the copyright law of Japan and other countries, and related Conventions.

**2 GRANT OF LICENCE**

- ① Subject to the conditions of this Agreement, JVC grants to You a non-exclusive right to use the Program. You may install and use the Program on a HDD or other storage devices incorporated in Your PC.
- ② You may make one (1) copy of the Program solely for your personal backup or archival purposes.

**3 RESTRICTION ON THE PROGRAM**

- ① You may not reverse engineer, decompile, disassemble, revise or modify the Program, except to the extent that expressly permitted by applicable law.
- ② You may not copy or use the Program, in whole or in part, other than as expressly specified in this Agreement.
- ③ You have no right to grant a licence to use the Program, and may not distribute, rent, lease or transfer the Program to any third party or otherwise let them use the Program.

**4 LIMITED WARRANTY**

JVC warrants that any media in which the Program is embodied are free from any defects in materials and workmanship for a period of thirty (30) days from the date of Your purchasing any our products accompanying the Program. JVC's entire liability and your exclusive remedy in connection with the Program shall be replacement of such defective media. EXCEPT FOR THE EXPRESS WARRANTIES STATED HEREIN AND TO THE EXTENT PERMITTED BY APPLICABLE LAW, JVC AND ITS LICENSORS DISCLAIM ANY OTHER WARRANTIES, EITHER EXPRESS OR IMPLIED, INCLUDING BUT NOT LIMITED TO IMPLIED WARRANTIES OF MERCHANTABILITY AND FITNESS FOR A PARTICULAR PURPOSE IN REGARD TO THE PROGRAM AND THE ACCOMPANYING PRINTED MATERIALS. SHOULD THERE BE ANY PROBLEM ARISING FROM OR CAUSED BY THE PROGRAM, YOU SHOULD SETTLE ALL SUCH PROBLEM AT YOUR OWN COST AND EXPENSE.

**5 LIMITED LIABILITY**

TO THE EXTENT PERMITTED BY APPLICABLE LAW, IN NO EVENT SHALL JVC AND ITS LICENSORS BE LIABLE FOR ANY INDIRECT, SPECIAL, INCIDENTAL OR CONSEQUENTIAL DAMAGES WHATSOEVER, REGARDLESS OF THE FORM OF ACTION WHETHER IN CONTRACT, TORT OR OTHERWISE ARISING OUT OF OR IN CONNECTION WITH THE USE OF OR INABILITY TO USE THE PROGRAM, EVEN IF JVC HAS BEEN ADVISED OF THE POSSIBILITY OF SUCH DAMAGES. YOU WILL INDEMNIFY AND HOLD HARMLESS JVC FROM ANY LOSS, LIABILITY OR COST ARISING OUT OF OR IN ANY WAY CONNECTED TO CLAIMS FROM ANY THIRD PARTY RELATING TO THE USE OF THE PROGRAM.

**6 TERM**

This Agreement will become effective on the date when You install and use the Program on Your machine, and continue to be in effect until the termination under the following provision.

Should You breach any provision of this Agreement, JVC may terminate this Agreement without giving any notice to You. In this event, JVC may claim against You for any damages caused by Your breach. Should this Agreement be terminated, You must immediately destroy the Program stored in Your machine (including the erasing from any memory in Your PC), and no longer own such Program.

**7 EXPORT CONTROL**

You agree that You will not ship, transfer or export the Program or underlying information and technology to any countries to which Japan and other relevant countries have initiated an embargo on such goods.

**8 U.S. GOVERNMENT USER**

If You are an agency of the United States of America (the "Government"), You acknowledge JVC's representation that the Program is a "Commercial Item" as defined in Federal Acquisition Regulation (FAR) part 2.101 (g) consisting unpublished "Commercial Computer Software" as those items are used at FAR part 12.212 and is only licenced to You with the same use rights JVC grants all commercial end users pursuant to the terms of this Agreement.

**9 GENERAL**

- ① No modification, change, addition, deletion or other alternation of or to this Agreement will be valid unless reduced to writing and signed by an authorized representative of JVC.
- ② If any part of this Agreement is held invalid by or in conflict with any law having jurisdiction over this Agreement, the remaining provisions will remain in full force and effect.
- ③ This Agreement shall be governed by and interpreted under the laws of Japan. The Tokyo District Court has jurisdiction over all disputes which may arise with respect to the execution, interpretation and performance of this Agreement.

Victor Company of Japan, Limited

**Memo:**

- If You acquired the Program in Germany, the provisions of Sections 4 (Limited Warranty) and 5 (Limited Liability) provided above will be replaced with those of the German version of this Agreement.

**CAUTION:**

- Operate this equipment according to the operating procedures described in this manual.
- Use only the provided CD-ROM. Never use any other CD-ROM to run this software.
- Do not attempt to modify this software.
- Changes or modifications not approved by JVC could void user's authority to operate the equipment.

**How to handle a CD-ROM :**

- Take care not to soil or scratch the mirror surface (opposite to the printed surface). Do not write anything or put a sticker on either the front or back surface. If the CD-ROM gets dirty, gently wipe it with a soft cloth outward from the center hole.
- Do not use conventional disc cleaners or cleaning spray.
- Do not bend the CD-ROM or touch its mirror surface.
- Do not store your CD-ROM in a dusty, hot or humid environment. Keep it away from direct sunlight.

You can find the latest information (in English) on the provided software program at our world wide web server at <http://www.jvc-victor.co.jp/english/global-e.html>

**Backing Up Files Without Using Provided Software**

Copy the files to a PC using the following method.

- 1** Connect the USB cable and AC adapter.

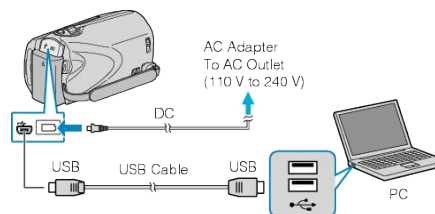

- ① Connect the AC adapter to this unit.
- ② Connect using the provided USB cable.

- 2** Open the LCD monitor.

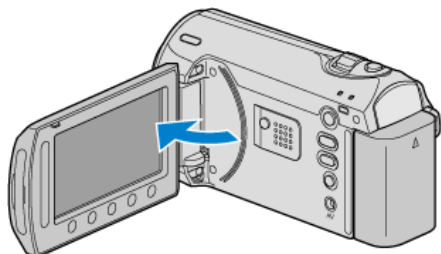

- When the folders or files are deleted/moved/renamed in the computer, they cannot be played back on this unit anymore.

- The USB MENU appears.
- 3 Select "PLAYBACK ON PC" and touch **OK**.



- Close the Everio MediaBrowser program, if it starts.
  - The subsequent operations are to be performed on the PC.
- 4 Select "Computer" (Windows Vista) / "My Computer" (Windows XP) from the start menu, then click on the EVERIO\_MEM or EVERIO\_SD icon.
- The folder opens.
- 5 Copy the files to any folder in the PC (desktop, etc).

**CAUTION:**

- When the folders or files are deleted/moved/renamed in the computer, they cannot be played back on this unit anymore.

**Memo:**

- To edit the files, use a software that supports MOD/JPEG files.
- The above operations on PC may vary with the system used.

**Disconnecting this Unit from PC**

- 1 Click "Safely Remove Hardware".

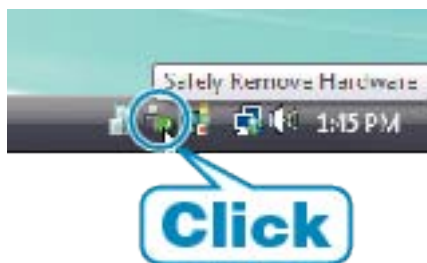

- 2 Click "Safely Remove USB Mass Storage Device".
- 3 (For Windows Vista) Click "OK".
- 4 Disconnect the USB cable and close the LCD monitor.

**List of Files and Folders**

Folders and files are created in the built-in memory and SD card as shown below.

They are created only when necessary.

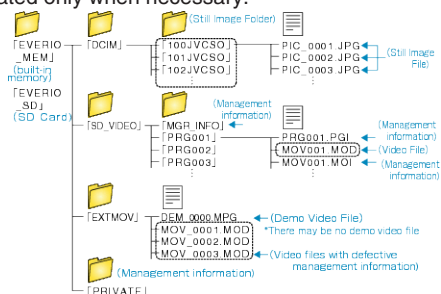

**CAUTION:**

## Copying to Mac Computer

Copy the files to a Mac computer using the following method.

1 Connect the USB cable and the AC adapter.

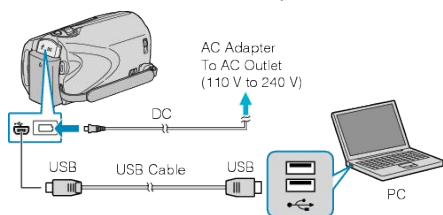

- ① Connect the AC adapter to this unit.
- ② Connect using the provided USB cable.
  - The provided software is not required for this process.

2 Open the LCD monitor.

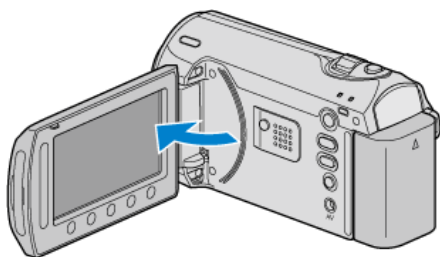

- The USB MENU appears.

3 Select "PLAYBACK ON PC" and touch .



- The subsequent operations are to be performed on the PC.

4 Click on the "EVERIO\_MEM" or "EVERIO\_SD" icon on the desktop.

- The folder opens.

5 Click on the column display icon.

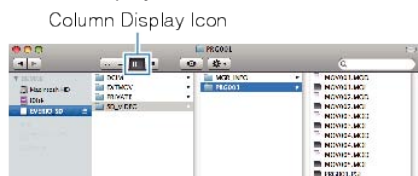

- Search the folder with the desired files.

6 Copy the files to any folder in the PC (desktop, etc).



### CAUTION:

- When the folders or files are deleted/moved/renamed in the computer, they cannot be played back on this unit anymore.
- MOD files that are copied to a Mac computer cannot be imported to iMovie. To use MOD files with iMovie, import the files using iMovie.

### Memo:

- To edit the files, use a software that supports MOD/JPEG files.
- When removing this unit from the computer, drag and drop the "EVERIO\_MEM" or "EVERIO\_SD" icon on the desktop to the trash bin.

## iMovie and iPhoto

You can import files from this unit to a computer using Apple's iMovie'08, '09 (video) or iPhoto (still image).

To verify the system requirements, select "About This Mac" from the Apple menu. You can determine the operating system version, processor and amount of memory.

- For the latest information on iMovie or iPhoto, refer to the Apple website.
- For details on how to use iMovie or iPhoto, refer to the help file of the respective software.
- There is no guarantee that the operations will work with all computer environments.

## Operating the Menu

Use the slider and operation buttons to set the menu.

- The menu differs according to the mode in use.

1 Touch  to display the menu.

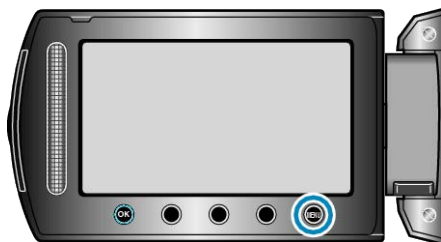



2 Select the desired menu and touch .



3 Select the desired setting and touch .



### Memo:

- To close the menu, touch .
- To return to the previous screen, touch .
- To display the help file, touch .

Returning All Settings to Default :

- Set using "FACTORY PRESET" in the camera settings menu.

"FACTORY PRESET" ( P.93)

## Recording Menu (Video)

You can adjust various settings, such as brightness and white balance, to suit the subject or purpose. You can also change settings such as picture quality and gain.

| Setting               | Details   |
|-----------------------|---|
| MANUAL SETTING        | Recording settings can be adjusted manually.<br><ul style="list-style-type: none"> <li>They are displayed only when recording in the manual mode.</li> </ul> "Manual Recording" (P.24)                                |
| LIGHT                 | Turns on/off the light.<br>"LIGHT" (P.73)   |
| REGISTER EVENT        | Categorizes your videos according to events (such as "Travel", "Athletic Meet") by registering the file before recording.<br>"Registering Files to Events Before Recording" (P.30)                                    |
| VIDEO QUALITY         | Sets the video quality.<br>"VIDEO QUALITY" (P.73)   |
| ZOOM                  | Sets the maximum zoom ratio.<br>"ZOOM" (P.74)   |
| GAIN UP               | Makes the subject appear bright automatically when recording in dark places.<br>"GAIN UP" (P.74)  |
| TIME-LAPSE RECORDING  | Enables the changes of a scene that occur slowly over a long period to be shown within a short time by taking frames of it at a certain interval.<br>"Recording at Intervals (TIME-LAPSE RECORDING)" (P.32)           |
| AUTO REC              | Enables the unit to start or stop recording automatically by sensing the changes in brightness within the red frame displayed on the LCD monitor.<br>"Recording Automatically by Sensing Movements (AUTO REC)" (P.34) |
| AUTO SWITCH REC MEDIA | Switches to another recording media to continue recording when the remaining space on the current recording media runs out.<br>"AUTO SWITCH REC MEDIA" (P.75)   |
| SELECT ASPECT RATIO   | Recording with aspect ratio 16:9 or 4:3 can be performed.<br>"SELECT ASPECT RATIO" (P.75)   |
| WIND CUT              | Reduces the noise caused by wind.<br>"WIND CUT" (P.76)  |



### LIGHT

Turns on/off the light.

| Setting | Details   |
|---------|---|
| OFF     | Does not light up.                                    |
| AUTO    | Lights up automatically when the surrounding is dark. |
| ON      | Lights up at all times.                               |

#### Displaying the Item

1 Select video mode.

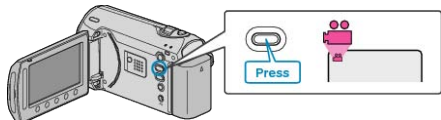

2 Touch **OK** to display the menu.

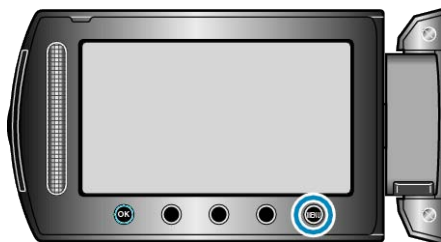

3 Select "LIGHT" and touch **OK**.



### REGISTER EVENT

Categorizes your videos according to events (such as "Travel", "Athletic Meet") by registering the file before recording.

Operating Details

"Registering Files to Events Before Recording" (P.30)

### VIDEO QUALITY

Sets the video quality.

| Setting    | Details  |
|------------|--|
| ULTRA FINE | Enables recording in the best picture quality. |
| FINE       | Enables recording in high picture quality.     |
| NORMAL     | Enables recording in standard quality.         |
| ECONOMY    | Enables long recordings.                       |

#### Displaying the Item

1 Select video mode.

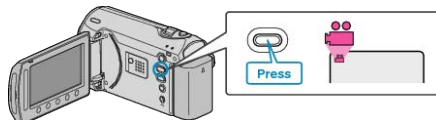

2 Touch **OK** to display the menu.

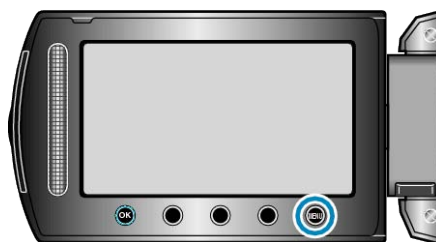

3 Select "VIDEO QUALITY" and touch **OK**.



#### Memo:

- You can change the video quality from the remaining recording time display. Select the video quality with the slider and touch **OK**.

## ZOOM

Sets the maximum zoom ratio.

| Setting                 | Details                     |
|-------------------------|-----------------------------|
| 39x/OPTICAL             | Enables zooming up to 39x.  |
| 45x/DYNAMIC             | Enables zooming up to 45x.  |
| 90x/DIGITAL             | Enables zooming up to 90x.  |
| 800x/DIGITAL (GZ-MS230) | Enables zooming up to 800x. |
| 900x/DIGITAL (GZ-MS215) | Enables zooming up to 900x. |

### Memo:

- You can expand the zoom area without degrading the image quality by using dynamic zoom.
- When digital zoom is used, the image becomes grainy as it is digitally enlarged.

### Displaying the Item

- 1 Select video mode.

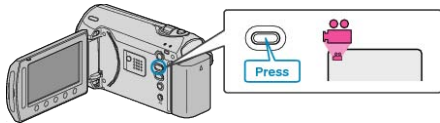

- 2 Touch **MEM** to display the menu.

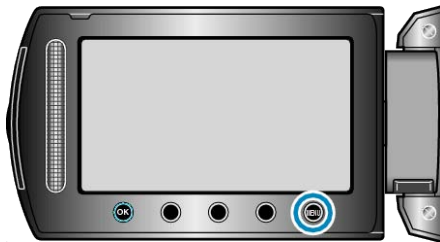

- 3 Select "ZOOM" and touch **OK**.



## GAIN UP

Makes the subject appear bright automatically when recording in dark places.

| Setting | Details  |
|---------|--|
| OFF     | Deactivates the function.                          |
| AGC     | Electrically brightens the scene when it is dark.  |
| AUTO    | Automatically brightens the scene when it is dark. |

### Memo:

- Although "AUTO" brightens the scene more than "AGC", movements of the subject may become unnatural.
- Setting can be adjusted separately for still images.

"GAIN UP(Still Image)" (P.80)

### Displaying the Item

- 1 Select video mode.

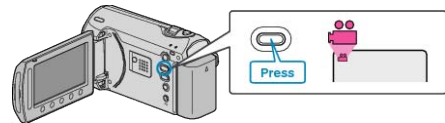

- 2 Touch **MEM** to display the menu.

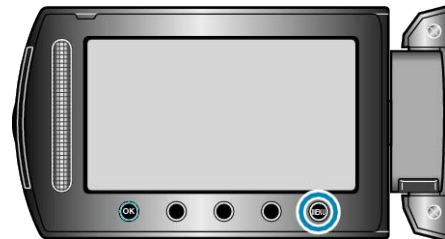

- 3 Select "GAIN UP" and touch **OK**.



## TIME-LAPSE RECORDING

This function enables the changes of a scene that occur slowly over a long period to be shown within a short time by taking frames of it at a certain interval.

This is useful for making observations such as the opening of a flower bud.

Operating Details

"Recording at Intervals (TIME-LAPSE RECORDING)" (P.32)

## AUTO REC

Records automatically by sensing the changes in brightness.

Operating Details

"Recording Automatically by Sensing Movements (AUTO REC)" (P.34)

### AUTO SWITCH REC MEDIA

Switches to another recording media to continue recording when the remaining space on the current recording media runs out.

- Recording may be slightly disrupted due to time lag when switching media.

| Setting | Details  |
|---------|--|
| OFF     | Does not switch recording media automatically. |
| ON      | Switches recording media automatically.        |

#### Displaying the Item

- 1 Select video mode.

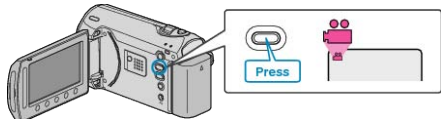

- 2 Touch **Ⓜ** to display the menu.

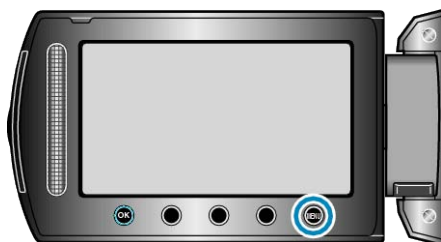

- 3 Select "AUTO SWITCH REC MEDIA" and touch **Ⓚ**.



### SELECT ASPECT RATIO

Recording with aspect ratio 16:9 or 4:3 can be performed.

| Setting | Details                        |
|---------|--------------------------------|
| 16:9    | Sets the aspect ratio to 16:9. |
| 4:3     | Sets the aspect ratio to 4:3.  |

#### Displaying the Item

- 1 Select video mode.

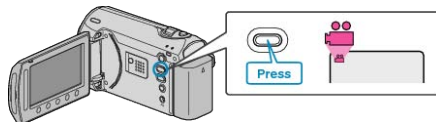

- 2 Touch **Ⓜ** to display the menu.

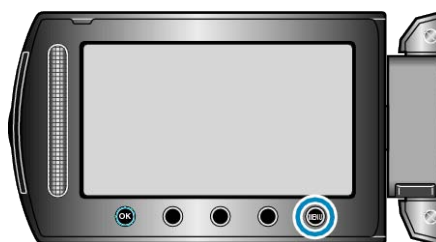

- 3 Select "SELECT ASPECT RATIO" and touch **Ⓚ**.



### WIND CUT

Reduces the noise caused by wind.

| Setting | Details                   |
|---------|---------------------------|
| OFF     | Deactivates the function. |
| ON      | Activates the function.   |

### Displaying the Item

- 1 Select video mode.

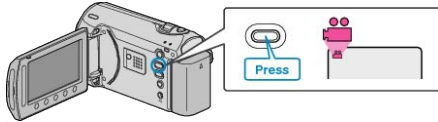

- 2 Touch  to display the menu.

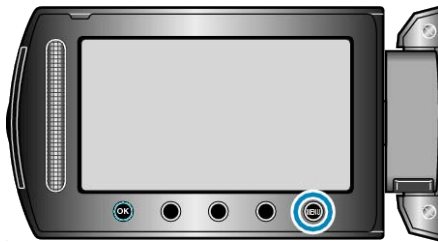

- 3 Select "WIND CUT" and touch .



## Recording Menu (Still Image)

You can adjust various settings, such as brightness and white balance, to suit the subject or purpose. You can also change settings such as picture quality and gain.

| Setting        | Details   |
|----------------|---|
| MANUAL SETTING | Recording settings can be adjusted manually.<br><ul style="list-style-type: none"> <li>They are displayed only when recording in the manual mode.</li> </ul> "Manual Recording" (P.24)                            |
| LIGHT          | Turns on/off the light.<br>"LIGHT" (P.78)   |
| SELF-TIMER     | Use this when taking a group photo.<br>"SELF-TIMER" (P.78)  |
| SHUTTER MODE   | Continuous shooting settings can be adjusted.<br>"SHUTTER MODE" (P.79)  |
| IMAGE QUALITY  | Sets the image quality.<br>"IMAGE QUALITY" (P.79)   |
| GAIN UP        | Makes the subject appear bright automatically when recording in dark places.<br>"GAIN UP" (P.80)  |
| AUTO REC       | Enables the unit to record still images automatically by sensing the changes in brightness within the red frame displayed on the LCD monitor.<br>"Recording Automatically by Sensing Movements (AUTO REC)" (P.34) |

## LIGHT

Turns on/off the light.

| Setting | Details   |
|---------|---|
| OFF     | Does not light up.                                    |
| AUTO    | Lights up automatically when the surrounding is dark. |
| ON      | Lights up at all times.                               |

### Displaying the Item

- 1 Select still image mode.

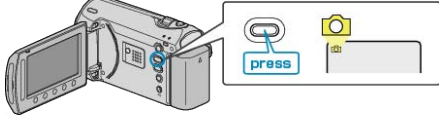

- 2 Touch **Ⓜ** to display the menu.

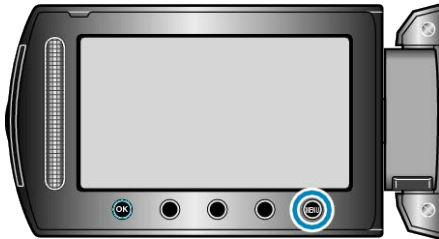

- 3 Select "LIGHT" and touch **Ⓞ**.



## SELF-TIMER

It is convenient to use the 10-second self-timer when taking a group photo.

Using the 2-second self-timer also helps to prevent camera shake caused by pressing the SNAPSHOT button.

| Setting | Details   |
|---------|---|
| OFF     | Deactivates the self-timer.   |
| 2SEC    | Starts recording 2 seconds after the SNAPSHOT button is pressed.  |
| 10SEC   | Starts recording 10 seconds after the SNAPSHOT button is pressed. This setting is suitable for taking group photos. |

### Displaying the Item

- 1 Select still image mode.

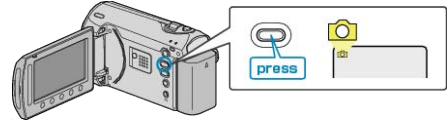

- 2 Touch **Ⓜ** to display the menu.

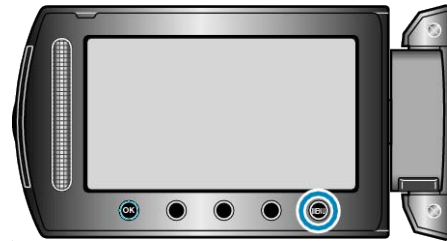

- 3 Select "SELF-TIMER" and touch **Ⓞ**.



### SHUTTER MODE

Continuous shooting settings can be adjusted.

| Setting             | Details   |
|---------------------|---|
| RECORD ONE SHOT     | Records one still image.  |
| CONTINUOUS SHOOTING | Records still images continuously while the SNAPSHOT button is pressed. |

**Memo:**

- Up to 3 images can be captured in 1 second during continuous shooting.
- Some SD cards may not support continuous shooting.
- The continuous shooting speed will drop if this function is used repeatedly.

### Displaying the Item

1 Select still image mode.

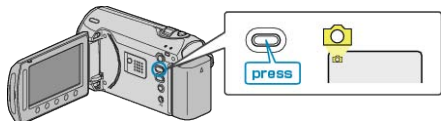

2 Touch **Ⓜ** to display the menu.

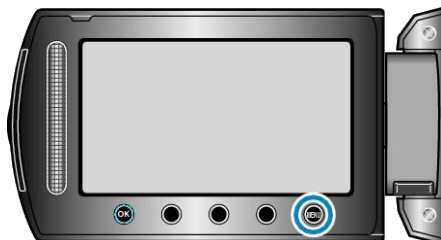

3 Select "SHUTTER MODE" and touch **Ⓚ**.



### IMAGE QUALITY

Sets the image quality.

| Setting  | Details  |
|----------|--|
| FINE     | Enables recording in high picture quality, but number of recordable images becomes lesser. |
| STANDARD | Enables recording in standard quality.   |

### Displaying the Item

1 Select still image mode.

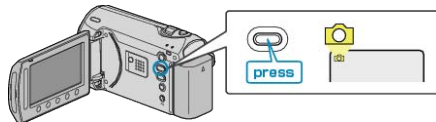

2 Touch **Ⓜ** to display the menu.

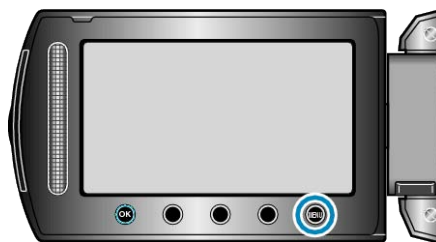

3 Select "IMAGE QUALITY" and touch **Ⓚ**.



### GAIN UP

Makes the subject appear bright automatically when recording in dark places.

| Setting | Details   |
|---------|---|
| OFF     | Deactivates the function.                         |
| AGC     | Electrically brightens the scene when it is dark. |

#### Memo:

- Setting can be adjusted separately for videos.

"GAIN UP(Video)" (P.74)

---

### Displaying the Item

- 1 Select still image mode.

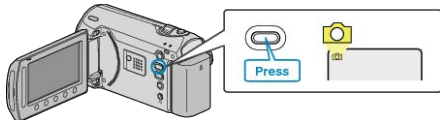

- 2 Touch **Ⓜ** to display the menu.



- 3 Select "GAIN UP" and touch **Ⓞ**.



### AUTO REC

Records automatically by sensing the changes in brightness.

Operating Details

"Recording Automatically by Sensing Movements (AUTO REC)" (P.34)



## Manual Settings Menu

Recording settings can be adjusted manually.

### Memo:

- They are displayed only when recording in the manual mode.

| Setting             | Details   |
|---------------------|---|
| SCENE SELECT        | Settings to suit the shooting condition can be selected.<br>"Scene Selection" (P.25)  |
| FOCUS               | Focus can be adjusted manually.<br>"Adjusting Focus Manually" (P.26)  |
| BRIGHTNESS ADJUST   | Adjusts the overall brightness of the screen.<br>"Adjusting Brightness" (P.27)  |
| SHUTTER SPEED       | Shutter speed can be adjusted.<br>"Setting Shutter Speed" (P.27)  |
| WHITE BALANCE       | Adjusts the color according to the light source.<br>"Setting White Balance" (P.28)  |
| BACKLIGHT COMP.     | Corrects the image when the subject appears dark due to backlight.<br>"Setting Backlight Compensation" (P.28)                       |
| METERING AREA/ TYPE | Enables you to adjust the brightness in the desired area.<br>"Setting Metering Area" (P.29)   |
| EFFECT              | Records videos or still images with special effects such as sepia or black and white.<br>"Recording with Effects (GZ-MS230)" (P.29) |
| TELE MACRO          | Enables close-up shots when using the telephoto (T) end of the zoom.<br>"Taking Close-up Shots" (P.30)                              |

### SCENE SELECT

Settings to suit the shooting condition can be selected.

Operating Details

"Scene Selection" (P.25)

### FOCUS

Focus can be adjusted automatically or manually.

Operating Details

"Adjusting Focus Manually" (P.26)

### BRIGHTNESS ADJUST

Adjusts the overall brightness of the screen.

Operating Details

"Adjusting Brightness" (P.27)

### SHUTTER SPEED

Shutter speed can be adjusted.

Operating Details

"Setting Shutter Speed" (P.27)

### WHITE BALANCE

Adjusts the color according to the light source.

Operating Details

"Setting White Balance" (P.28)

### BACKLIGHT COMP.

Corrects the image when the subject appears dark due to backlight.

Operating Details

"Setting Backlight Compensation" (P.28)

### METERING AREA/TYPE

Enables you to adjust the brightness in the desired area.

Operating Details

"Setting Metering Area" (P.29)

### EFFECT (GZ-MS230)

Records videos or still images with special effects such as sepia or black and white.

Operating Details

"Recording with Effects (GZ-MS230)" (P.29)

### TELE MACRO

Enables close-up shots when using the telephoto (T) end of the zoom.

Operating Details

"Taking Close-up Shots" (P.30)

## Playback Menu (Video)

You can delete or look for specific videos.

| Setting           | Details  |
|-------------------|--|
| DELETE            | Deletes unwanted videos.<br>"Deleting the Currently Displayed File" (P.43)<br>"Deleting Selected Files" (P.44)<br>"Deleting All Files" (P.45)  |
| SEARCH            | Refines the index screen of videos according to group, recording date, or event.<br>"Group Search" (P.40)<br>"Date Search" (P.40)<br>"Event and Date Search" (P.41)  |
| PLAYBACK PLAYLIST | Play back the playlists that you have created.<br>"Playing Back Playlists" (P.42)  |
| EDIT PLAYLIST     | Creates or edits a playlist.<br>"Creating Playlists with Selected Files" (P.53)<br>"Creating Playlists by Group" (P.54)<br>"Creating Playlists by Date" (P.55)<br>"Creating Playlists by Event" (P.56)<br>"Editing Playlists" (P.57)<br>"Deleting Playlists" (P.58)  |
| PLAYBACK MPG FILE | Plays videos with defective management information.<br>"Playing a Video with Defective Management Information" (P.38)  |
| EDIT              | <ul style="list-style-type: none"> <li>● COPY<br/>Copies files to another media.<br/>"Copying All Files" (P.59)<br/>"Copying Selected Files" (P.60)</li> <li>● MOVE<br/>Moves files to another media.<br/>"Moving All Files" (P.61)<br/>"Moving Selected Files" (P.62)</li> <li>● PROTECT/CANCEL<br/>Protects files from being deleted accidentally.<br/>"Protecting the Currently Displayed File" (P.45)<br/>"Protecting Selected Files" (P.46)<br/>"Protecting All Files" (P.47)<br/>"Releasing Protection of All Files" (P.47)</li> <li>● TRIMMING<br/>Select the required part of a video and save it as a new video file.<br/>"Capturing a Required Part in the Video" (P.50)</li> <li>● CHANGE EVENT REG.<br/>Changes the event that is registered.<br/>"Changing the Event of the Currently Displayed File" (P.48)<br/>"Changing the Event of the Selected Files" (P.49)</li> </ul> |
| ON-SCREEN DISPLAY | Sets whether to show on-screen displays such as icons during playback.<br>"ON-SCREEN DISPLAY" (P.84)   |

**DELETE**

Deletes unwanted videos.

Operating Details

"Deleting the Currently Displayed File" (P.43)

"Deleting Selected Files" (P.44)

"Deleting All Files" (P.45)

**SEARCH**

Refines the index screen of videos according to group, recording date, or event.

Operating Details

"Group Search" (P.40)

"Date Search" (P.40)

"Event and Date Search" (P.41)

**PLAYBACK PLAYLIST**

Play back the playlists that you have created.

Operating Details

"Playing Back Playlists" (P.42)

**EDIT PLAYLIST**

A list in which your favorite videos are arranged is called a playlist.

By creating a playlist, you can play back only your favorite videos in the order you like.

The original video file remains even when it is registered to a playlist.

Operating Details

"Creating Playlists with Selected Files" (P.53)

"Creating Playlists by Group" (P.54)

"Creating Playlists by Date" (P.55)

"Creating Playlists by Event" (P.56)

"Editing Playlists" (P.57)

"Deleting Playlists" (P.58)

**PLAYBACK MPG FILE**

Plays videos with defective management information.

Operating Details

"Playing a Video with Defective Management Information" (P.38)

**EDIT**

You can perform operations such as copying or protecting videos.

| Setting                 | Details  |
|-------------------------|--|
| COPY                    | Copies files to another media.<br>"Copying All Files" (P.59)<br>"Copying Selected Files" (P.60)  |
| MOVE                    | Moves files to another media.<br>"Moving All Files" (P.61)<br>"Moving Selected Files" (P.62)   |
| PROTECT/<br>CANCEL      | Protects files from being deleted accidentally.<br>"Protecting the Currently Displayed File" (P.45)<br>"Protecting Selected Files" (P.46)<br>"Protecting All Files" (P.47)<br>"Releasing Protection of All Files" (P.47) |
| TRIMMING                | Select the required part of a video and save it as a new video file.<br>"Capturing a Required Part in the Video" (P.50)  |
| CHANGE<br>EVENT<br>REG. | Changes the event that is registered.<br>"Changing the Event of the Currently Displayed File" (P.48)<br>"Changing the Event of the Selected Files" (P.49)  |

**COPY**

Copies files to another media.

Operating Details

"Copying All Files" (P.59)

"Copying Selected Files" (P.60)

**MOVE**

Moves files to another media.

Operating Details

"Moving All Files" (P.61)

"Moving Selected Files" (P.62)

**PROTECT/CANCEL**

Protects files from being deleted accidentally.

Operating Details

"Protecting the Currently Displayed File" (P.45)

"Protecting Selected Files" (P.46)

"Protecting All Files" (P.47)

"Releasing Protection of All Files" (P.47)

**TRIMMING**

Select the required part of a video and save it as a new video file.

Operating Details

"Capturing a Required Part in the Video" (P.50)

**CHANGE EVENT REG.**

Changes the event that is registered.

Operating Details

"Changing the Event of the Currently Displayed File" (P.48)

"Changing the Event of the Selected Files" (P.49)

## ON-SCREEN DISPLAY

Sets whether to show on-screen displays such as icons during playback.

| Setting           | Details                 |
|-------------------|-------------------------|
| OFF               | No display at all.      |
| DISPLAY ALL       | Displays everything.    |
| DISPLAY DATE ONLY | Displays the date only. |

### Displaying the Item

1 Select the playback mode.

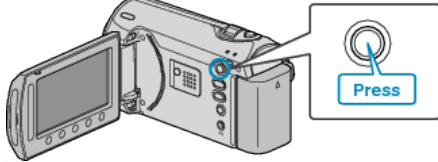

2 Select video mode.

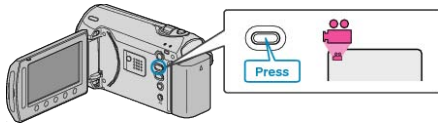

3 Touch **Ⓜ** to display the menu.

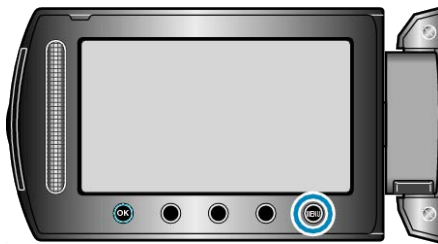

4 Select "ON-SCREEN DISPLAY" and touch **Ⓚ**.



## Playback Menu (Still Image)

You can delete or look for specific still images.

| Setting            | Details  |
|--------------------|--|
| DELETE             | Deletes unwanted still images.<br>"Deleting the Currently Displayed File" (P.43)<br>"Deleting Selected Files" (P.44)<br>"Deleting All Files" (P.45)  |
| SEARCH DATE        | You can search and play videos or still images according to recording dates.<br>"Date Search" (P.40)   |
| EDIT               | <ul style="list-style-type: none"> <li>● COPY<br/>Copies files to another media.<br/>"Copying All Files" (P.59)<br/>"Copying Selected Files" (P.60)</li> <li>● MOVE<br/>Moves files to another media.<br/>"Moving All Files" (P.61)<br/>"Moving Selected Files" (P.62)</li> <li>● PROTECT/CANCEL<br/>Protects files from being deleted accidentally.<br/>"Protecting the Currently Displayed File" (P.45)<br/>"Protecting Selected Files" (P.46)<br/>"Protecting All Files" (P.47)<br/>"Releasing Protection of All Files" (P.47)</li> </ul> |
| SLIDE SHOW EFFECTS | Effects can be added to the transitions in slideshow playback.<br>"SLIDE SHOW EFFECTS" (P.86)  |
| ON-SCREEN DISPLAY  | Sets whether to show on-screen displays such as icons during playback.<br>"ON-SCREEN DISPLAY" (P.87)   |

### DELETE

Deletes unwanted still images.

Operating Details

"Deleting the Currently Displayed File" (P.43)

"Deleting Selected Files" (P.44)

"Deleting All Files" (P.45)

### MOVE

Moves files to another media.

Operating Details

"Moving All Files" (P.61)

"Moving Selected Files" (P.62)

### SEARCH DATE

You can search and play videos or still images according to recording dates.

Operating Details

"Date Search" (P.40)

### EDIT

You can perform operations such as copying or protecting still images.

| Setting            | Details  |
|--------------------|--|
| COPY               | Copies files to another media.<br>"Copying All Files" (P.59)<br>"Copying Selected Files" (P.60)  |
| MOVE               | Moves files to another media.<br>"Moving All Files" (P.61)<br>"Moving Selected Files" (P.62)   |
| PROTECT/<br>CANCEL | Protects files from being deleted accidentally.<br>"Protecting the Currently Displayed File" (P.45)<br>"Protecting Selected Files" (P.46)<br>"Protecting All Files" (P.47)<br>"Releasing Protection of All Files" (P.47) |

### COPY

Copies files to another media.

Operating Details

"Copying All Files" (P.59)

"Copying Selected Files" (P.60)

## PROTECT/CANCEL

Protects files from being deleted accidentally.

Operating Details

"Protecting the Currently Displayed File" (P.45)

"Protecting Selected Files" (P.46)

"Protecting All Files" (P.47)

"Releasing Protection of All Files" (P.47)

## SLIDE SHOW EFFECTS

Effects can be added to the transitions in slideshow playback.

| Setting      | Details  |
|--------------|--|
| SLIDE        | Switches the screen by sliding in from right to left.                                |
| BLINDS       | Switches the screen by dividing into vertical strips.                                |
| CHECKERBOARD | Switches the screen by changing through a checkered pattern.                         |
| RANDOM       | Switches the screen with a random effect from "SLIDE", "BLINDS", and "CHECKERBOARD". |

### Displaying the Item

1 Select the playback mode.

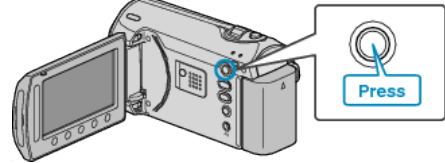

2 Select still image mode.

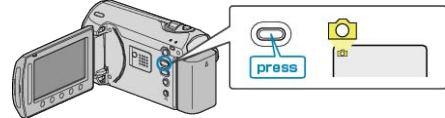

3 Touch  $\text{MENU}$  to display the menu.

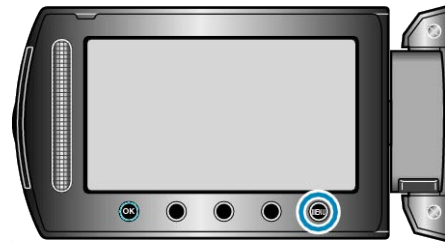

4 Select "SLIDE SHOW EFFECTS" and touch  $\text{OK}$ .



## ON-SCREEN DISPLAY

Sets whether to show on-screen displays such as icons during playback.

| Setting           | Details                 |
|-------------------|-------------------------|
| OFF               | No display at all.      |
| DISPLAY ALL       | Displays everything.    |
| DISPLAY DATE ONLY | Displays the date only. |

### Displaying the Item

1 Select the playback mode.

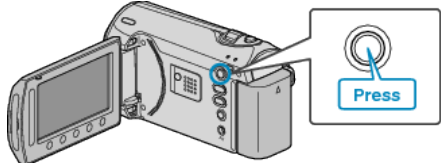

2 Select still image mode.

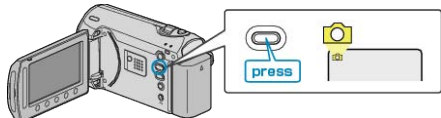

3 Touch **Ⓜ** to display the menu.



4 Select "ON-SCREEN DISPLAY" and touch **Ⓜ**.



## Display Settings Menu

You can adjust various display settings such as the LCD monitor's brightness, etc.

| Setting            | Details  |
|--------------------|--|
| LANGUAGE           | The language on the display can be changed.<br>"Changing the Display Language" (P.16)                    |
| DATE DISPLAY STYLE | Sets the order of year, month, day and the time display format (24H/12H).<br>"DATE DISPLAY STYLE" (P.88) |
| MONITOR BRIGHTNESS | Sets the brightness of the LCD monitor.<br>"MONITOR BRIGHTNESS" (P.88)                                   |
| LCD BACKLIGHT      | Sets the brightness of the backlight of the monitor.<br>"LCD BACKLIGHT" (P.89)                           |

### LANGUAGE

The language on the display can be changed.

Operating Details

"Changing the Display Language" (P.16)

### DATE DISPLAY STYLE

Sets the order of year, month, day and the time display format (24H/12H).

1 Touch to display the menu.

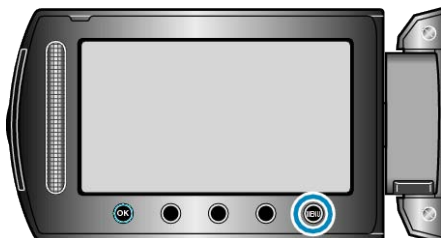

2 Select "DISPLAY SETTINGS" and touch .



3 Select "DATE DISPLAY STYLE" and touch .



4 Set the style of date and time display.



- For date display, set to any format from "month.day.year", "year.month.day", and "day.month.year".
- For time display, set to any format from "12h" and "24h".
- Touch the operation buttons "←" / "→" to move the cursor.
- After setting, touch .

### MONITOR BRIGHTNESS

Sets the brightness of the LCD monitor.

1 Touch to display the menu.

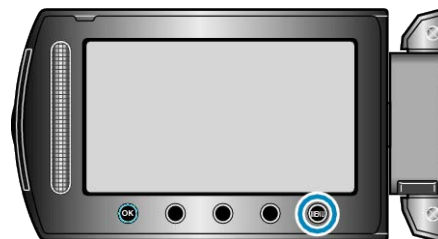

2 Select "DISPLAY SETTINGS" and touch .



3 Select "MONITOR BRIGHTNESS" and touch .



4 Adjust the brightness of the monitor.

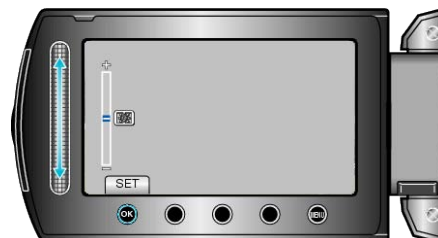

- Slide upward to increase the brightness.
- Slide downward to decrease the brightness.
- After setting, touch .



## LCD BACKLIGHT

Sets the brightness of the backlight of the monitor.

| Setting  | Details   |
|----------|---|
| BRIGHTER | Brightens the backlight of the monitor regardless of the surrounding conditions.                          |
| STANDARD | Helps to save battery life when selected.   |
| AUTO     | Sets the brightness automatically to "BRIGHTER" when using outdoors and to "STANDARD" when using indoors. |

## Displaying the Item

1 Touch **Ⓜ** to display the menu.

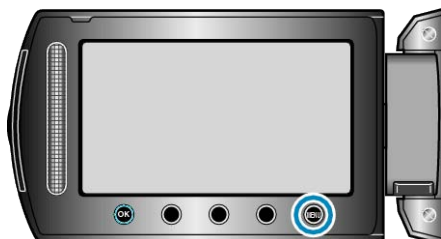

2 Select "DISPLAY SETTINGS" and touch **OK**.



3 Select "LCD BACKLIGHT" and touch **OK**.



## CLOCK ADJUST

Resets the current time or sets to the local time when using this unit overseas.

Operating Details

"Clock Setting" (P.15)

"Setting the Clock to Local Time when Traveling" (P.18)

"Setting Daylight Saving Time" (P.19)

### Basic Settings Menu

You can adjust various camera settings such as operation sound, etc.

| Setting         | Details  |
|-----------------|--|
| DEMO MODE       | Introduces the special features of this unit in digest form.<br>"DEMO MODE" (P.91)   |
| AUTO POWER OFF  | Prevents the situation of forgetting to turn off the power when this is set.<br>"AUTO POWER OFF" (P.91)  |
| OPERATION SOUND | Turns on or off the operation sound.<br>"OPERATION SOUND" (P.92)   |
| RECORD BUTTON   | Displays the REC button on the LCD monitor and enables it to be used as the START/STOP button.<br>"RECORD BUTTON" (P.92)                       |
| QUICK RESTART   | Reduces the power consumption within 5 minutes after the LCD monitor is closed to 1/3 of that used during recording.<br>"QUICK RESTART" (P.93) |
| UPDATE          | Updates the functions of this unit to the latest version.<br>"UPDATE" (P.93)   |
| FACTORY PRESET  | Returns all the settings to their default values.<br>"FACTORY PRESET" (P.93)   |

### DEMO MODE

Starts playback of the demo mode which introduces the features of this unit.

| Setting | Details   |
|---------|---|
| OFF     | Deactivates the function.                                   |
| ON      | Plays a demonstration of the special features of this unit. |

#### Displaying Demo Mode

- ① Remove the battery pack and SD card.
- ② Connect the AC adapter.
- ③ Open the LCD monitor and turn on the power.
  - Demonstration starts playing after 3 minutes.
  - To stop playback, touch **OK**.

#### Memo:

- This mode is not available in the playback mode.

#### Displaying the Item

- 1 Touch **MENU** to display the menu.

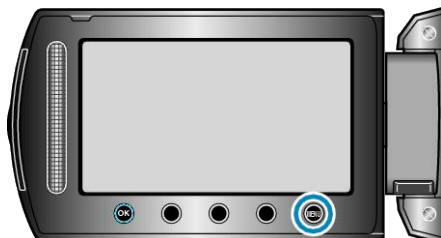

- 2 Select "BASIC SETTINGS" and touch **OK**.



- 3 Select "DEMO MODE" and touch **OK**.



### AUTO POWER OFF

Prevents the situation of forgetting to turn off the power when this is set.

| Setting | Details   |
|---------|---|
| OFF     | Power is not turned off even if this unit is not operated for 5 minutes.      |
| ON      | Turns off the power automatically if this unit is not operated for 5 minutes. |

#### Memo:

- When using battery, power is turned off automatically if this unit is not operated for 5 minutes.
- When using the AC adapter, this unit goes into standby mode.

#### Displaying the Item

- 1 Touch **MENU** to display the menu.

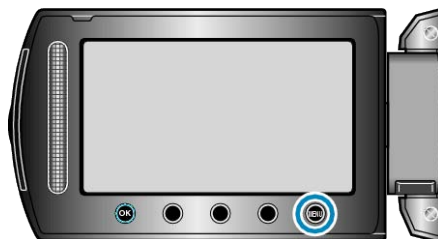

- 2 Select "BASIC SETTINGS" and touch **OK**.



- 3 Select "AUTO POWER OFF" and touch **OK**.



## OPERATION SOUND

Turns on or off the operation sound.

| Setting | Details                        |
|---------|--------------------------------|
| OFF     | Turns off the operation sound. |
| ON      | Turns on the operation sound.  |

### Displaying the Item

1 Touch **MENU** to display the menu.

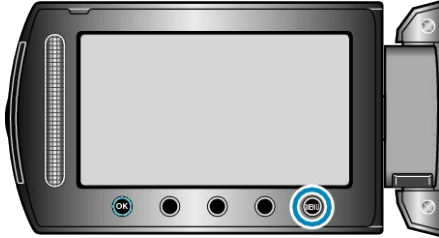

2 Select "BASIC SETTINGS" and touch **OK**.



3 Select "OPERATION SOUND" and touch **OK**.



## RECORD BUTTON

Displays the "REC" button on the LCD monitor and enables it to be used as the START/STOP button.

| Setting | Details                                     |
|---------|---|
| OFF     | No display.                                 |
| ON      | Displays the REC button on the LCD monitor. |

### Displaying the Item

1 Touch **MENU** to display the menu.

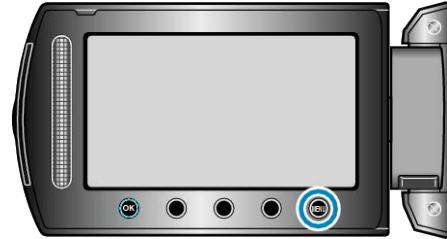

2 Select "BASIC SETTINGS" and touch **OK**.



3 Select "RECORD BUTTON" and touch **OK**.



### QUICK RESTART

Enables recording to be performed immediately when the LCD monitor is opened.

| Setting | Details   |
|---------|---|
| OFF     | Deactivates the function.   |
| ON      | Enables the power to turn on quickly when the LCD monitor is opened again within 5 minutes. |

#### Displaying the Item

1 Touch **MENU** to display the menu.

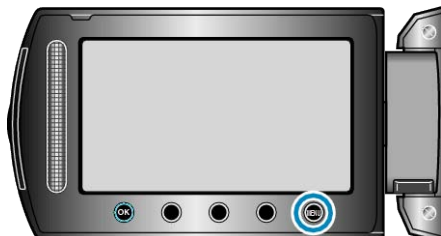

2 Select "BASIC SETTINGS" and touch **OK**.



3 Select "QUICK RESTART" and touch **OK**.



- The power consumption within 5 minutes after the LCD monitor is closed is reduced to 1/3 of that used during recording.

### UPDATE

Updates the functions of this unit to the latest version. For details, refer to the JVC homepage.

(When no program to update the software of this unit is available, nothing will be provided on the homepage.)

### FACTORY PRESET

Returns all the settings to their default values.

1 Touch **MENU** to display the menu.

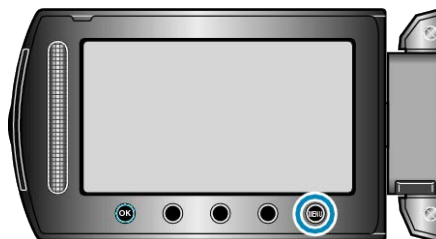

2 Select "BASIC SETTINGS" and touch **OK**.



3 Select "FACTORY PRESET" and touch **OK**.



4 Select "YES" and touch **OK**.



- All settings return to their default values.

## Connection Settings Menu

You can adjust various settings for connecting to a TV or DVD recorder.

| Setting       | Details  |
|---------------|--|
| DISPLAY ON TV | Displays icons and date/time on a TV screen.<br>"DISPLAY ON TV" (P.94)                       |
| VIDEO OUTPUT  | Sets the aspect ratio (16:9 or 4:3) according to the connecting TV.<br>"VIDEO OUTPUT" (P.94) |

### DISPLAY ON TV

Displays icons and date/time on a TV screen.

| Setting | Details                                     |
|---------|---|
| OFF     | Does not display icons and date/time on TV. |
| ON      | Displays icons and date/time on TV.         |

#### Displaying the Item

- 1 Touch  to display the menu.

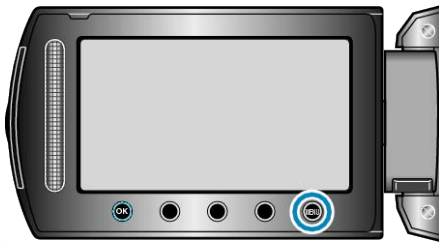

- 2 Select "CONNECTION SETTINGS" and touch .



- 3 Select "DISPLAY ON TV" and touch .



### VIDEO OUTPUT

Sets the aspect ratio (16:9 or 4:3) according to the connecting TV.

| Setting | Details   |
|---------|---|
| 16:9    | Select this when connecting to a widescreen TV (16:9).  |
| 4:3     | Select this when connecting to a conventional TV (4:3). |

#### Displaying the Item

- 1 Touch  to display the menu.

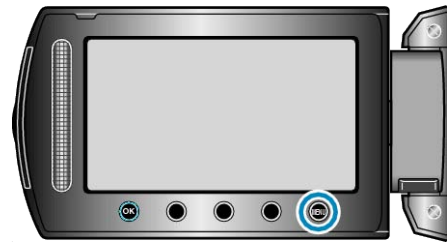

- 2 Select "CONNECTION SETTINGS" and touch .



- 3 Select "VIDEO OUTPUT" and touch .



## Media Settings Menu

You can perform various settings for the recording media.

| Setting              | Details   |
|----------------------|---|
| REC MEDIA FOR VIDEO  | Sets the recording/playback media of videos.<br>"REC MEDIA FOR VIDEO (GZ-MS230)" (P.95)                                 |
| VIDEO SLOT SELECTION | Sets the recording/playback SD slot of videos.<br>"VIDEO SLOT SELECTION (GZ-MS215)" (P.95)                              |
| REC MEDIA FOR IMAGE  | Sets the recording/playback media of still images.<br>"REC MEDIA FOR IMAGE (GZ-MS230)" (P.96)                           |
| IMAGE SLOT SELECTION | Sets the recording/playback SD slot of still images.<br>"IMAGE SLOT SELECTION (GZ-MS215)" (P.96)                        |
| FORMAT BUILT-IN MEM. | Deletes all files on the built-in memory.<br>"FORMAT BUILT-IN MEM. (GZ-MS230)" (P.97)                                   |
| FORMAT SD CARD       | Deletes all files on the SD card.<br>"FORMAT SD CARD" (P.97)  |
| ERASE ALL DATA       | Execute this process when disposing of this unit or passing it to another person.<br>"ERASE ALL DATA (GZ-MS230)" (P.98) |

### REC MEDIA FOR VIDEO (GZ-MS230)

Sets the recording/playback media of videos.

| Setting         | Details  |
|-----------------|--|
| BUILT-IN MEMORY | Records videos to the camcorder's built-in memory. |
| SD CARD         | Records videos to the SD card.                     |

#### Displaying the Item

1 Touch **Ⓜ** to display the menu.



2 Select "MEDIA SETTINGS" and touch **Ⓚ**.



3 Select "REC MEDIA FOR VIDEO", and touch **Ⓚ**.



### VIDEO SLOT SELECTION (GZ-MS215)

Sets the recording/playback media of videos.

| Setting | Details                                  |
|---------|--|
| SLOT A  | Records videos to the SD card in slot A. |
| SLOT B  | Records videos to the SD card in slot B. |

#### Displaying the Item

1 Touch **Ⓜ** to display the menu.

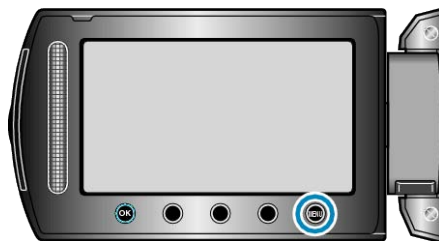

2 Select "MEDIA SETTINGS" and touch **Ⓚ**.



3 Select "VIDEO SLOT SELECTION" and touch **Ⓚ**.



## REC MEDIA FOR IMAGE (GZ-MS230)

Sets the recording/playback media of still images.

| Setting         | Details  |
|-----------------|--|
| BUILT-IN MEMORY | Records still images to the camcorder's built-in memory. |
| SD CARD         | Records still images to the SD card.                     |

### Displaying the Item

- 1 Touch to display the menu.

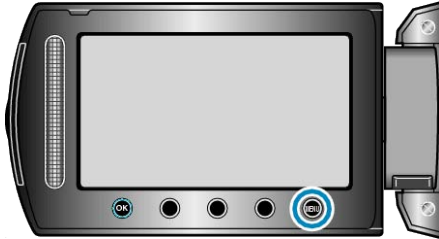

- 2 Select "MEDIA SETTINGS" and touch .



- 3 Select "REC MEDIA FOR IMAGE" and touch .



## IMAGE SLOT SELECTION (GZ-MS215)

Sets the recording/playback media of still images.

| Setting | Details  |
|---------|--|
| SLOT A  | Records still images to the SD card in slot A. |
| SLOT B  | Records still images to the SD card in slot B. |

### Displaying the Item

- 1 Touch to display the menu.

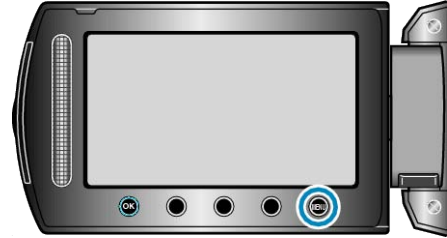

- 2 Select "MEDIA SETTINGS" and touch .



- 3 Select "IMAGE SLOT SELECTION" and touch .





### FORMAT BUILT-IN MEM. (GZ-MS230)

Deletes all files on the built-in memory.

| Setting              | Details   |
|----------------------|---|
| FILE                 | Deletes all files on the built-in memory.   |
| FILE + MANAGEMENT NO | Deletes all files on the internal memory and resets the folder and file numbers to "1". |

#### CAUTION:

- All data on the built-in memory will be deleted when it is formatted. Copy all files on the built-in memory to a PC before formatting.
- Make sure that the battery pack is fully charged or connect the AC adapter as the formatting process may take some time.

#### Displaying the Item

1 Touch **OK** to display the menu.

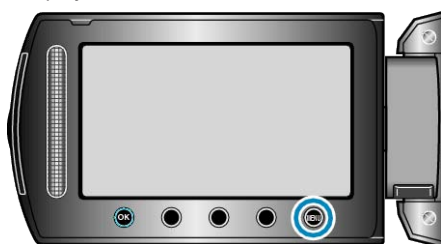

2 Select "MEDIA SETTINGS" and touch **OK**.



3 Select "FORMAT BUILT-IN MEM." and touch **OK**.



### FORMAT SD CARD

Deletes all files on the SD card.

| Setting              | Details   |
|----------------------|---|
| FILE                 | Deletes all files on the SD card.   |
| FILE + MANAGEMENT NO | Deletes all files on the SD card and resets the folder and file numbers to "1". |

#### CAUTION:

- Not available for selection when no SD card is inserted.
- All data on the card will be deleted when it is formatted. Copy all files on the card to a PC before formatting.
- Make sure that the battery pack is fully charged or connect the AC adapter as the formatting process may take some time.

#### Displaying the Item

1 Touch **OK** to display the menu.

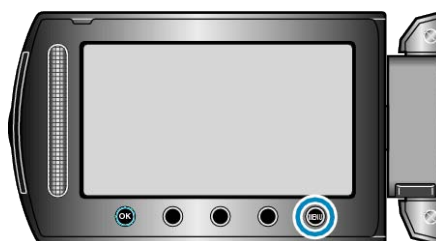

2 Select "MEDIA SETTINGS" and touch **OK**.



3 Select "FORMAT SD CARD" and touch **OK**.



(GZ-MS230)

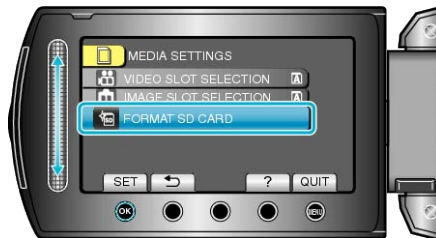

(GZ-MS215)

- Select the media to be formatted.

### ERASE ALL DATA (GZ-MS230)

Execute this process when disposing of this unit or passing it to another person.

1 Touch  to display the menu.



2 Select "MEDIA SETTINGS" and touch .



3 Select "ERASE ALL DATA" and touch .



4 Select "YES" and touch .



- After deleting the data, touch .

#### CAUTION:

- Connect the AC adapter as it may take some time to delete data.

#### Memo:

- Repeat the process to make data restoration even more difficult.

## Front

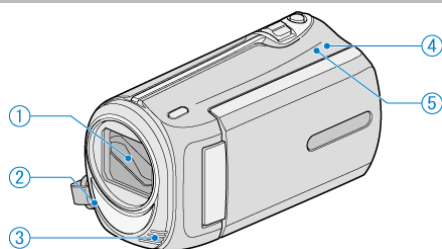
**1** Lens/Lens Cover

- Do not touch the lens and lens cover.

**2** Light

- Turn on the light when shooting in dark places.
- "LIGHT" (P.73)

**3** Stereo Microphone

- Do not cover the microphone with your fingers during video recording.

**4** POWER/CHARGE Lamp

- Lights up: Power "ON"
- Blinks: Charging in progress
- Goes out: Charging finished

**5** ACCESS Lamp

- Recording or playback is in progress when the lamp lights up or blinks.
- Do not remove the battery pack, AC adapter, or SD card.

## Rear

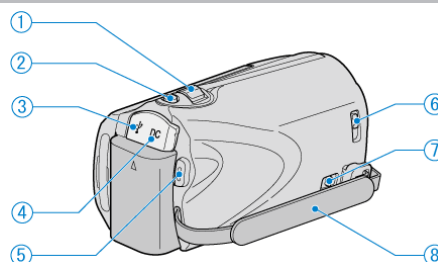
**1** Zoom/Volume Lever

- During shooting: Adjusts the shooting range.
- During playback (index screen): Changes the number of images to display.
- During video playback: Adjusts the volume.

**2** SNAPSHOT (Still image recording) Button

- Takes a still image.

**3** USB Terminal

- Connects to PC using a USB cable.

**4** DC Terminal

- Connects to an AC adapter to charge the battery.

**5** START/STOP (Video recording) Button

- Starts/stops video recording.

**6** Lens Cover Switch

- Opens and closes the lens cover.

**7** Grip Belt Release Lever

- Allows the grip belt to be removed and used as a hand strap.

**8** Grip Belt

- Pass your hand through the grip belt to hold this unit firmly.
- "Grip Adjustment" (P.13)

## Bottom

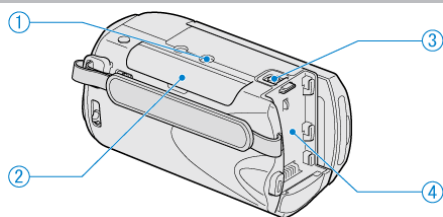

### 1 Tripod Mounting Hole

"Tripod Mounting" (P.17)

### 2 SD Card Slot

- Insert an optional SD card.

"Inserting an SD Card (GZ-MS230)" (P.13)

"Inserting an SD Card (GZ-MS215)" (P.14)

### 3 Battery Release Lever

"Charging the Battery Pack" (P.12)

### 4 Battery Mount

## Interior

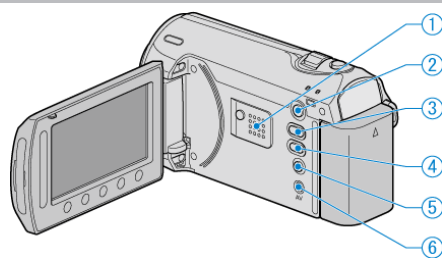

### 1 Speaker

- Outputs audio sound during video playback.

### 2 (Play) Button

- Switches between the recording and playback modes.

### 3 (Video/Still Image) Button

- Switches between video and still image.

### 4 UPLOAD/EXPORT (Upload/Export to iTunes) Button

- Recording: Takes videos in YouTube or iTunes format.
- Playback: Changes the video to YouTube or iTunes format.

### 5 (Power/Info) Button

- Recording: Displays the remaining time (for video only) and battery power.
- Playback: Displays file information such as recording date.
- Press and hold to turn the power on/off while the LCD monitor is opened.

### 6 AV Terminal

- Connects to a TV.

## LCD Monitor

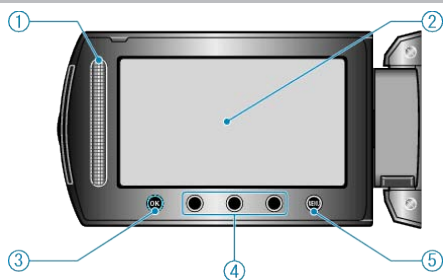

### 1 Slider LASER TOUCH OPERATION

- Selects items or images from the menu or index screen.  
"Using the Operation Buttons" (P.16)

### 2 LCD Monitor

- Turns the power on/off by opening and closing.
- Enables self-portraits to be taken by rotating the monitor.

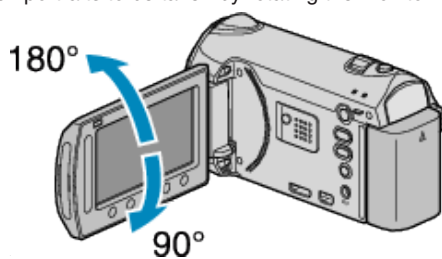

### 3 OK Button

- Confirms the selected item or image.

### 4 Operation Buttons

- Functions of the operation buttons may be displayed.

### 5 MENU Button

- Displays the settings menu.

### CAUTION:

- Do not press against the surface with force or subject it to strong impact.  
Doing so may damage or break the screen.

## Common Recording Indications

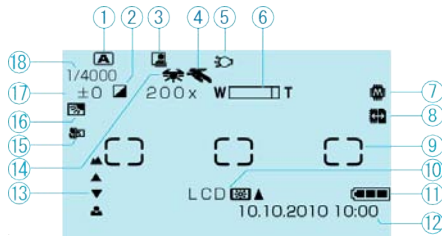

### 1 Recording Mode

"Taking Videos in Auto Mode" ( P.20)

"Manual Recording" ( P.24)

### 2 Effect

"Recording with Effects (GZ-MS230)" ( P.29)

### 3 Auto REC

"Recording Automatically by Sensing Movements (AUTO REC)" ( P.34)

### 4 Scene Select

"Scene Selection" ( P.25)

### 5 Light

"LIGHT" ( P.73)

### 6 Zoom

"ZOOM" ( P.74)

### 7 Media

"REC MEDIA FOR VIDEO (GZ-MS230)" ( P.95)

"VIDEO SLOT SELECTION (GZ-MS215)" ( P.95)

"REC MEDIA FOR IMAGE (GZ-MS230)" ( P.96)

"IMAGE SLOT SELECTION (GZ-MS215)" ( P.96)

### 8 AUTO SWITCH REC MEDIA

"AUTO SWITCH REC MEDIA" ( P.75)

### 9 Metering Area "SPOT"

"Setting Metering Area" ( P.29)

### 10 Monitor Backlight

"LCD BACKLIGHT" ( P.89)

### 11 Battery Indicator

"Remaining Recording Time/Battery Power" ( P.35)

### 12 Date/Time

"Clock Setting" ( P.15)

### 13 Focus

"Adjusting Focus Manually" ( P.26)

### 14 White Balance

"Setting White Balance" ( P.28)

### 15 Tele Macro

"Taking Close-up Shots" ( P.30)

### 16 Backlight Compensation

"Setting Backlight Compensation" ( P.28)

### 17 Brightness

"Adjusting Brightness" ( P.27)

### 18 Shutter Speed

"Setting Shutter Speed" ( P.27)

## Video Recording

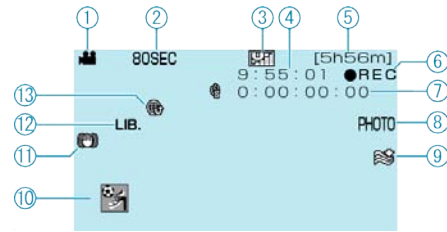

### 1 Video Mode

"Interior" ( P.100)

### 2 Time-Lapse Recording

"Recording at Intervals (TIME-LAPSE RECORDING)" ( P.32)

### 3 Video Quality

"VIDEO QUALITY" ( P.73)

### 4 Scene Counter

### 5 Remaining Recording Time

### 6 Recording in Progress

"Taking Videos in Auto Mode" ( P.20)

### 7 Time-Lapse Recording Counter

"Recording at Intervals (TIME-LAPSE RECORDING)" ( P.32)

### 8 Still Image Recording

"Capturing Still Images During Video Recording" ( P.21)

### 9 Wind Cut

"WIND CUT" ( P.76)

### 10 Event Recording

"Registering Files to Events Before Recording" ( P.30)

### 11 DIS

"Reducing Camera Shake" ( P.22)

### 12 EXPORT Recording

"Taking Videos in iTunes Format" ( P.32)



### 13 UPLOAD Recording

"Taking Videos in YouTube Format" ( P.31)

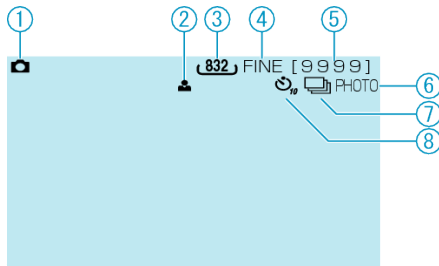
## Still Image Recording



### 1 Still Image Mode

" /  (Video/Still Image) Button" (P.100)

### 2 Focus

"Taking Still Images in Auto Mode" (P.22)

### 3 Image Size

### 4 Image Quality

"IMAGE QUALITY" (P.79)

### 5 Remaining Number of Shots

### 6 Recording in Progress

### 7 Continuous Shooting

"SHUTTER MODE" (P.79)



### 8 Self-Timer

"SELF-TIMER" (P.78)

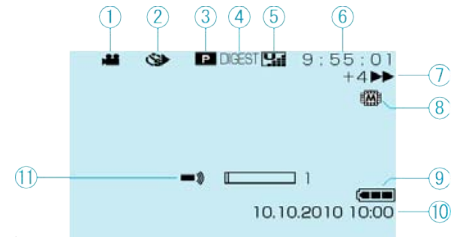
## Video Playback



### 1 Video Mode

" /  (Video/Still Image) Button" (P.100)

### 2 Time-Lapse Recording

"Recording at Intervals (TIME-LAPSE RECORDING)" (P.32)

### 3 Playlist Playback

"Playing Back Playlists" (P.42)

### 4 Digest Playback

"Checking the Content of Videos Quickly" (P.38)

### 5 Video Quality

"VIDEO QUALITY" (P.73)

### 6 Scene Counter

### 7 Operation Indicator

"Playing Back Videos" (P.37)

### 8 Media

"REC MEDIA FOR VIDEO (GZ-MS230)" (P.95)

"VIDEO SLOT SELECTION (GZ-MS215)" (P.95)

### 9 Battery Indicator

"Remaining Recording Time/Battery Power" (P.35)

### 10 Date/Time



"Clock Setting" (P.15)

### 11 Speaker Volume Adjustment

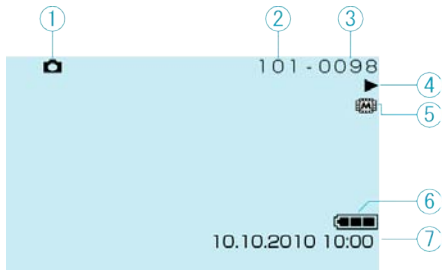
## Still Image Playback



**1** Still Image Mode

" /  (Video/Still Image) Button" (☞ P.100)

**2** Folder Number

**3** File Number

**4** Operation Indicator

"Playing Back Still Images" (☞ P.39)

**5** Media

"REC MEDIA FOR IMAGE (GZ-MS230)" (☞ P.96)

"IMAGE SLOT SELECTION (GZ-MS215)" (☞ P.96)

**6** Battery Indicator

"Remaining Recording Time/Battery Power" (☞ P.35)

**7** Date/Time

"Clock Setting" (☞ P.15)



## Battery Pack

### Unable to turn on the power when using the battery pack.

Recharge the battery pack.  
"Charging the Battery Pack" (P.12)

If the terminal of this unit or the battery pack is dirty, wipe it with a cotton swab or something similar.

If you use any other battery packs besides JVC battery packs, safety and performance can not be guaranteed. Be sure to use JVC battery packs.

### Short usage time even after charging.

Battery deterioration occurs when a battery pack is charged repeatedly. Replace the battery pack with a new one.  
"Optional Accessories" (P.19)

### Unable to charge the battery pack.



When the battery pack is fully charged, the lamp does not flash.  
If the terminal of this unit or the battery pack is dirty, wipe it with a cotton swab or something similar.  
Using a non-original battery pack may result in damage to this unit. Be sure to use an original battery pack.

### The remaining battery display is not correct.

Remaining battery power is not displayed when the AC adapter is connected.  
If this unit is used for long periods of time in high or low temperatures, or if the battery pack is repeatedly charged, the amount of remaining battery may not be displayed correctly.

## Recording

### Recording cannot be performed.

Check the  switch.  
"Interior" (P.100)  
Set to the recording mode with the  (Play) Button.  
"Interior" (P.100)

### Recording stops automatically.

Recording stops automatically as it cannot be performed for 12 or more consecutive hours according to specifications. (It may take some time to resume recording.)  
Turn off the power, wait for a while, and start recording again. (This unit stops automatically to protect the circuit when the temperature rises.)

### DIS does not work.

DIS does not work when recording still images.

### The continuous shooting speed of still images is slow.

The continuous shooting speed will drop if this function is used repeatedly.  
Continuous shooting speed may drop depending on the SD card or under certain recording conditions.

### The focus is not adjusted automatically.

If you are recording in a dark place or a subject that has no contrast between dark and light, adjust the focus manually.  
"Adjusting Focus Manually" (P.26)  
Wipe the lens with a lens cleaning cloth.  
Cancel manual focus on the manual recording menu.  
"Adjusting Focus Manually" (P.26)

### Digital zoom does not work.

Digital zoom is not available in the still image recording mode.  
Zoom operation is not available in time-lapse shooting. (Simultaneous still image recording and DIS are also not available.)  
To use digital zoom, set "ZOOM" in the menu to "90x/DIGITAL" or "800x/DIGITAL".

"ZOOM" (P.74)

## Card

### Cannot insert the SD card.

Make sure not to insert the card in the wrong direction.  
"Inserting an SD Card (GZ-MS230)" (P.13)

### Unable to copy to SD card.

To record to the card, it is necessary to perform media settings.  
"REC MEDIA FOR VIDEO (GZ-MS230)" (P.95)  
To use cards that have been used on other devices, it is necessary to format (initialize) the card using "FORMAT SD CARD" from media settings.  
"FORMAT SD CARD" (P.97)

## Playback

### Sound or video is interrupted.

Sometimes playback is interrupted at the connecting section between two scenes. This is not a malfunction.

### The same image is displayed for a long time.

Replace the SD card. (When the SD card is damaged, difficulty in reading the data occurs. This unit will try to play back as much as possible, but it will stop eventually if the condition persists.)  
Execute "FORMAT SD CARD" in the media settings menu. (All data will be deleted.)  
"FORMAT SD CARD" (P.97)

### The motion is choppy.

Replace the SD card. (When the SD card is damaged, difficulty in reading the data occurs. This unit will try to play back as much as possible, but it will stop eventually if the condition persists.)  
Execute "FORMAT SD CARD" in the media settings menu. (All data will be deleted.)  
"FORMAT SD CARD" (P.97)

### Cannot find a recorded file.

Cancel group display and date search functions.  
"Searching for a Specific Video/Still Image" (P.40)  
Change the setting in "REC MEDIA FOR VIDEO" or "REC MEDIA FOR IMAGE". (Files on other media are not displayed.)  
"REC MEDIA FOR VIDEO (GZ-MS230)" (P.95)  
"REC MEDIA FOR IMAGE (GZ-MS230)" (P.96)  
Select "PLAYBACK MPG FILE" then search the video on the index screen. (Video files that have damaged management information can be played back.)  
"Playing a Video with Defective Management Information" (P.38)

### No date/time display.

Set "ON-SCREEN DISPLAY" in the menu accordingly.  
"ON-SCREEN DISPLAY" (P.84)  
Set "DISPLAY ON TV" in the menu to "ON".  
"DISPLAY ON TV" (P.94)

### Images do not appear on the TV properly.

Disconnect the cable and connect again.  
Turn off and on this unit again.

### Images are projected vertically on the TV.

Set "VIDEO OUTPUT" in the connection settings menu to "4:3".  
"VIDEO OUTPUT" (P.94)  
Adjust the TV's screen accordingly.

### The image displayed on TV is too small.

Set "VIDEO OUTPUT" in the connection settings menu to "16:9".  
"VIDEO OUTPUT" (P.94)

### Unable to delete file.

Files that are protected cannot be deleted. Release protection before deleting the file.

"Protecting Files" (P.45)

## Editing/Copying

### Unable to dub to a Blu-ray recorder.

Dubbing cannot be performed by connecting this camcorder to a Blu-ray recorder with a USB cable. Connect and dub using the supplied AV cable.

"Dubbing Files to a DVD Recorder or VCR" (P.63)

### Unable to copy/move files to SD card.

If the SD card is write protected, set it to off.

## PC

### Unable to copy files to the PC's HDD.

Connect the USB cable correctly.

"Backing Up All Files" (P.65)

If the provided software "Everio MediaBrowser" is not installed, some functions may not work properly.

"Installing the Provided Software" (P.64)

Before making backup, make sure that enough free space is left in the PC's hard disk (HDD).

Still images cannot be recorded to disk using the provided software.

### Unable to copy files to DVD with a PC.

To record to discs, a recordable DVD drive is required for the PC in use.

### I am using a Mac PC.

"Copy the files to a Mac computer using the following method." (P.70)

### Cannot upload the file to YouTube.

Check if you have created an account with YouTube. (You need a YouTube account to upload files to YouTube.)

Upload recording can only be performed for up to 10 minutes, the time limit of YouTube.

Changing videos to the file format for uploading cannot be performed on this unit.

Refer to "Q&A", "Latest Information", "Download Information", etc. in "Click for Latest Product Info" in the help file of the provided Everio MediaBrowser software.

### Cannot export the file to iTunes.

Refer to "Q&A", "Latest Information", "Download Information", etc. in "Click for Latest Product Info" in the help file of the provided Everio MediaBrowser software.

## Screen/Image

### The LCD monitor is difficult to see.

The LCD monitor may be difficult to see if used in bright areas such as under direct sunlight.

### A band or a ball of bright light appears on the LCD monitor.

Change the direction of this unit to prevent the light source from coming into view. (A band or a ball of bright light may appear when there is a bright light source near this unit, but this is not a malfunction.)

### The recorded subject is too dark.

Use backlight compensation when the background is bright and the subject is dark.

"Setting Backlight Compensation" (P.28)

Use "LIGHT" in the menu.

"LIGHT" (P.73)

Use "NIGHT EYE" in SCENE SELECT.

"Scene Selection" (P.25)

Use "GAIN UP" in the menu.

"GAIN UP" (P.74)

Set "BRIGHTNESS ADJUST" in the manual settings menu to the "+" side.

"Adjusting Brightness" (P.27)

### The recorded subject is too bright.

Set the backlight compensation to "OFF" if it is being used.

"Setting Backlight Compensation" (P.28)

Set "BRIGHTNESS ADJUST" in the manual settings menu to the "-" side.

"Adjusting Brightness" (P.27)

### The color looks strange. (Too bluish, too reddish, etc.)

Wait for a while until natural colors are achieved. (It may take some time for white balance to be adjusted.)

Set "WHITE BALANCE" in the manual settings menu to "MANUAL". Select from "FINE"/"CLOUD"/"HALOGEN" according to the light source. Select "MWB" and adjust accordingly.

"Setting White Balance" (P.28)

## Other Problems

### The slider and operation buttons do not work.

Touch the slider and buttons around the screen with your fingers.

The slider and buttons do not function if you touch them with your fingernails or with gloves on.

The displays on the screen do not work even if you touch them.

### The unit operates slowly when switching between video mode and still image mode, or when switching the power on or off.

It is recommended that you copy all videos and still images onto your computer, and erase the files from this unit. (If there are many recorded files on this unit, it takes time for the unit to respond.)

### The image is grainy.

When digital zoom is used, the image becomes grainy as it is digitally enlarged.

### The unit heats up.

This is not a malfunction. (This unit may become warm when used for a long time.)

## Error Message?

### CHECK LENS COVER

Open the lens cover.

### SET DATE/TIME!

Connect the AC adapter, charge the battery for more than 24 hours and set the clock. (If the message still appears, the clock battery is exhausted. Consult your nearest JVC dealer.)

"Clock Setting" (P.15)

### COMMUNICATION ERROR

Reconnect the USB cable.

Turn off this unit and the devices connected to it, and turn them on again. Reattach the battery pack.

### FORMAT ERROR!

Check the operating procedure, and perform once again.

"FORMAT BUILT-IN MEM. (GZ-MS230)" (P.97)

Turn off this unit, and turn it on again.

### DATA DELETION ERROR (GZ-MS230 only)

Check the operating procedure, and perform once again.  
 "ERASE ALL DATA (GZ-MS230)" (P.98)  
 Turn off this unit, and turn it on again.

### ERROR IN BUILT-IN MEMORY! (GZ-MS230 only)

Turn off this unit, and turn it on again.  
 If the above does not solve the problem, back up your files and execute "FORMAT BUILT-IN MEM." in the media settings menu. (All data will be deleted.)  
 "FORMAT BUILT-IN MEM. (GZ-MS230)" (P.97)

### MEMORY CARD ERROR!

Turn off this unit, and turn it on again.  
 Remove and re-insert the SD card after detaching the AC adapter and battery pack.  
 Remove any dirt from the SD card terminals.  
 If the above does not solve the problem, back up your files and execute "FORMAT SD CARD" in the media settings menu. (All data will be deleted.)  
 "FORMAT SD CARD" (P.97)

### NOT FORMATTED

Select "OK", then select "YES" on the "DO YOU WANT TO FORMAT?" screen.

### RECORDING FAILURE

Turn off this unit, and turn it on again.

### CANNOT TAKE MORE STILL IMAGES AT THE MOMENT

Stop video recording before taking still images. (If the SD card is removed and inserted during video recording, still images cannot be recorded.)  
 Set "VIDEO QUALITY" in the menu to a setting other than "ECONOMY". (Simultaneous still image recording cannot be performed when set to "ECONOMY".)  
 "VIDEO QUALITY" (P.73)

### VIDEO MANAGEMENT FILE IS DAMAGED, RECOVERY IS REQUIRED TO RECORD/PLAYBACK, RECOVER?

Select "OK" to restore. (Videos that cannot be restored will not be displayed on the index screen, but you may be able to play them back using "PLAYBACK MPG FILE" in the menu.)  
 "Playing a Video with Defective Management Information" (P.38)

### UNSUPPORTED FILE!

Use files recorded with this unit. (Files recorded with other devices may not be playable.)

### THIS FILE IS PROTECTED

Switch off the "PROTECT/CANCEL" function in the "EDIT" menu.  
 "Protecting Files" (P.45)

### CHECK CARD'S WRITE PROTECTION SWITCH

Set the write protect switch of the SD card to off.

### INSUFFICIENT AVAILABLE SPACE

Delete files, or move files to a PC or other devices.  
 Replace the SD card with a new one.

### MAXIMUM QUANTITY RECORDING FOLDERS/FILES HAS BEEN REACHED

① Move the files or folders to a PC or other device. (Back up your files.)  
 ② Select "FILE + MANAGEMENT NO" in "FORMAT BUILT-IN MEM." (GZ-MS230) or "FORMAT SD CARD" (GZ-MS215) of the media settings menu. (All data on the built-in memory or SD card will be deleted.)

### NUMBER OF FOLDERS OVERFLOW

① Move the files or folders to a PC or other device. (Back up your files.)  
 ② Select "FILE + MANAGEMENT NO" in "FORMAT BUILT-IN MEM." (GZ-MS230) or "FORMAT SD CARD" (GZ-MS215) of the media settings menu. (All data on the built-in memory or SD card will be deleted.)

### FILE QUANTITY LIMIT EXCEEDED

① Move the files or folders to a PC or other device. (Back up your files.)  
 ② Select "FILE + MANAGEMENT NO" in "FORMAT BUILT-IN MEM." (GZ-MS230) or "FORMAT SD CARD" (GZ-MS215) of the media settings menu. (All data on the built-in memory or SD card will be deleted.)

### PLAYLIST QUANTITY EXCEEDS LIMIT

Reduce the number of the playlist to 99 files or less. (Up to 99 playlists can be created.)

### NO FILES

Change the setting in "REC MEDIA FOR VIDEO" or "REC MEDIA FOR IMAGE", and check that files are not recorded to the other media.  
 "REC MEDIA FOR VIDEO (GZ-MS230)" (P.95)  
 "REC MEDIA FOR IMAGE (GZ-MS230)" (P.96)

### NO REGISTERED EVENT SCENES

Set the event.  
 "Changing Event Registration of Videos" (P.48)

### NO REGISTERED SCENES IN PLAYLIST SOME SCENES MAY NOT PLAY BACK

Delete the playlist, and then create a new one.  
 "Creating Playlists from the Recorded Videos" (P.53)

## Maintenance

---

Perform regular maintenance of this unit to enable it to be used for a long time.

### CAUTION:

---

- Be sure to detach the battery pack, AC adapter, and power plug before performing any maintenance.
- 

## Camcorder

- Wipe this unit with a dry, soft cloth to remove any dirt.
- When it is extremely dirty, soak the cloth in a solution of neutral detergent, wipe the body with it, and then use a clean cloth to remove the detergent.

### CAUTION:

---

- Do not use benzene or thinner. Doing so may cause damage to the unit.
  - When using a chemical cloth or cleaner, be sure to observe the warning labels and instructions of the product.
  - Do not leave the device in contact with rubber or plastic products for a long time.
- 

## Lens/LCD Monitor

- Use a lens blower (commercially available) to remove any dust, and a cleaning cloth (commercially available) to wipe off any dirt.  
Mold may form if the lens is left dirty.

## Camera

| Item                                | Details  |
|-------------------------------------|--|
| Power supply                        | Using AC adapter: DC 5.2 V<br>Using battery pack: DC 3.6 V   |
| Power consumption                   | 1.5 W (when "LIGHT" is set to "OFF" and "LCD BACKLIGHT" is set to "STANDARD")  |
| Dimensions (mm)                     | 52 x 62 x 110 (W x H x D: excluding grip belt)   |
| Mass                                | Approx. 200 g (camera only),<br>Approx. 230 g (including supplied battery pack)  |
| Operating environment               | Allowable operating temperature: 0°C to 40°C<br>Allowable storage temperature: -20°C to 50°C<br>Allowable operating humidity: 35 % to 80 % |
| Image pickup device                 | 1/6" 800,000 pixels  |
| Recording area (Video)              | 410,000 pixels (optical zoom)<br>410,000 to 550,000 pixels (dynamic zoom)  |
| Recording area (Still Image)        | 550,000 pixels   |
| Lens                                | F1.8 to F4.3, f= 2.2 mm to 85.8 mm<br>(35 mm conversion: 41.5 mm to 1,619 mm)  |
| Lowest illumination                 | 3 lux (Shutter speed: AUTO + AGC)<br>1 lux (NIGHT EYE mode)  |
| Zoom (during video recording)       | Optical zoom: Up to 39x<br>Dynamic zoom: Up to 45x<br>Digital zoom: Up to 800x (GZ-MS230 only)<br>Digital zoom: Up to 900x (GZ-MS215 only) |
| Zoom (during still image recording) | Optical zoom: Up to 39x  |
| LCD monitor                         | 2.7" wide, 12.3 megapixels, polysilicon color LCD  |
| Recording Media (GZ-MS230)          | Built-in memory (8 GB),<br>SD/SDHC card (commercially available)<br>"Types of Usable SD Card" (P.14)                                       |
| Recording Media (GZ-MS215)          | SD/SDHC card (commercially available)<br>"Types of Usable SD Card" (P.14)  |
| Clock battery                       | Rechargeable battery   |

## Video

| Item                         | Details  |
|------------------------------|--|
| Recording/ Playback format   | SD-VIDEO standard, Video: MPEG-2, Audio: Dolby Digital(2ch)  |
| Extension                    | .MOD   |
| Signal system                | PAL standard   |
| Image quality/ Sound quality | ULTRA FINE :<br>720 pixels x 576 pixels, 8.5 Mbps VBR (Video),<br>48 kHz, 384 kbps (Audio) FINE :<br>720 pixels x 576 pixels, 5.5 Mbps VBR (Video),<br>48 kHz, 384 kbps (Audio) NORMAL :<br>720 pixels x 576 pixels, 4.2 Mbps VBR (Video),<br>48 kHz, 256 kbps (Audio) ECONOMY :<br>352 pixels x 288 pixels, 1.5 Mbps VBR (Video),<br>48 kHz, 128 kbps (Audio) |

## Still Image

| Item       | Details             |
|------------|---------------------|
| Format     | JPEG standard       |
| Extension  | .JPG                |
| Image size | 832 x 624 / 640x480 |
| Quality    | FINE / STANDARD     |

## AC Adapter (AP-V30M)

| Item                            | Details   |
|---------------------------------|---|
| Power supply                    | AC 110 V to 240 V, 50 Hz/60 Hz                        |
| OUTPUT                          | DC 5.2 V, 1.8 A                                       |
| Allowable operating temperature | 0°C to 40°C (10°C to 35°C during charging)            |
| Dimensions (mm)                 | 50 x 29 x 100 (W x H x D: excluding cord and AC plug) |
| Mass                            | Approx. 112 g   |

## Battery Pack (BN-VG107E)

| Item            | Details                    |
|-----------------|----------------------------|
| Power voltage   | 3.6 V                      |
| Capacity        | 700 mAh                    |
| Dimensions (mm) | 31 x 21.5 x 43 (W x H x D) |
| Mass            | Approx. 26 g               |

"Optional Accessories" (P.19)

**JVC**