

# JVC

**CAMCORDER**

---

**GZ-HM350**

**Detailed User Guide**

**GZ-HM330**

**GZ-HM300**

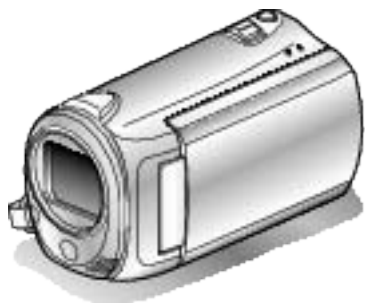

**Everio**

## Table of Contents

### Beginner's Guide

Charging .....	4
Recording .....	4
Playback .....	4
Shooting Tips .....	4

### Useful Shooting Techniques

Holiday Season/Christmas .....	4
Wedding .....	5
Travel .....	6
Amusement Park .....	8

### Getting Started

Verifying the Accessories .....	10
Charging the Battery Pack .....	11
Grip Adjustment .....	12
Using the Hand Strap .....	12
Inserting an SD Card (GZ-HM350/GZ-HM330) .....	13
Types of Usable SD Card .....	13
Inserting an SD Card (GZ-HM300) .....	14
Types of Usable SD Card .....	14
Clock Setting .....	15
Resetting the Clock .....	15
Using the Operation Buttons .....	16
Using the Slider .....	16
Holding this Unit .....	16
Using the Remote Control (GZ-HM350/GZ-HM330) .....	17
Attaching the Lens Cap (GZ-HM300) .....	18
Tripod Mounting .....	18
Using this Unit Overseas .....	18
Charging the Battery Pack Overseas .....	18
Setting the Clock to Local Time when Traveling .....	19
Setting Daylight Saving Time .....	19
Optional Accessories .....	20

### Recording

Taking Videos in Auto Mode .....	20
Zooming .....	22
Capturing Still Images During Video Recording .....	22
Reducing Camera Shake .....	23
Checking the Captured Image Immediately .....	23
Taking Still Images in Auto Mode .....	23
Zooming .....	25
Checking the Captured Image Immediately .....	25
Manual Recording .....	26
Scene Selection .....	27
Adjusting Focus Manually .....	28
Using Focus Assist .....	28
Adjusting Brightness .....	29
Setting Shutter Speed (GZ-HM350/GZ-HM330) .....	29
Setting White Balance .....	30
Setting Backlight Compensation .....	30
Setting Metering Area .....	31
Recording with Effects .....	31
Taking Close-up Shots .....	32
Registering Files to Events Before Recording .....	32
Taking Videos in YouTube™ Format .....	33
Taking Videos in iTunes Format (GZ-HM350/GZ-HM330) .....	34
Recording at Intervals (TIME-LAPSE RECORDING) .....	35
Recording Automatically by Sensing Movements (AUTO REC) .....	36
Remaining Recording Time/Battery Power .....	37

### Playback

Playing Back Videos .....	40
---------------------------	----

Checking the Content of Videos Quickly .....	41
Playing a Video with Defective Management Information .....	41
Playback with Special Effects .....	42
Playing Back Still Images .....	43
Slideshow Playback .....	43
Searching for a Specific Video/Still Image .....	44
Group Search .....	44
Search Date .....	44
Search Event .....	45
Connecting to and Viewing on TV .....	45
Connecting via the HDMI Mini Connector .....	46
Connecting via the Component Connector .....	47
Connecting via the AV Connector .....	47
Playing Back Playlists .....	48
Playing Back a BD/DVD Created on this Unit (GZ-HM350/GZ-HM330) .....	48

### Editing

Deleting Unwanted Files .....	49
Deleting the Currently Displayed File .....	49
Deleting Selected Files .....	50
Deleting All Files .....	51
Protecting Files .....	52
Protecting the Currently Displayed File .....	52
Protecting Selected Files .....	53
Protecting All Files .....	54
Releasing Protection of All Files .....	54
Changing Event Registration of Videos .....	55
Changing the Event of the Currently Displayed File .....	55
Changing the Event of the Selected Files .....	56
Dividing Files .....	57
Face Detection Zoom .....	58
Capturing a Still Image in the Video during Playback .....	59
Capturing a Required Part in the Video .....	59
Capturing Videos for Uploading to YouTube™ .....	60
Preparing Videos to Transfer to iTunes (GZ-HM350/GZ-HM330) .....	61
Creating a Playlist with Title (GZ-HM350/GZ-HM330) .....	62
Creating Playlists from the Recorded Videos .....	63
Creating Playlists with Selected Files .....	63
Creating Playlists by Group .....	64
Creating Playlists by Date .....	65
Creating Playlists by Event .....	66
Editing Playlists .....	67
Deleting Playlists .....	68
Adding Title Screens to Playlists (GZ-HM350/GZ-HM330) .....	69
Combining Videos Recorded by Seamless Recording .....	70

### Copying

Copying Files to Card .....	72
Copying All Files .....	72
Copying Selected Files .....	73
Moving Files .....	74
Moving All Files .....	74
Moving Selected Files .....	75
Creating Discs with a BD/DVD Writer (GZ-HM350/GZ-HM330) .....	76
Preparing a DVD Writer (CU-VD50) .....	76
Preparing a DVD Writer (CU-VD3) .....	77
Preparing a BD Writer .....	77
Selecting the Quality for Saving to Discs (CHANGE REC. MEDIA) .....	78
Copying All Files .....	78
Copying Files by Date .....	79
Copying Files by Event (video mode only) .....	80
Copying Selected Playlists (video mode only) .....	81
Copying Selected Files .....	82
Playing Back Files .....	83
Finalizing Discs After Copying .....	83

Changing Recording Media (video mode only) .....	83
Digest Playback .....	84
Using a USB External Hard Disk Drive (GZ-HM350/GZHM330) .....	84
Preparing a USB External Hard Disk Drive .....	85
Backing Up Files .....	85
Playing Back Files in the USB External Hard Disk Drive .....	86
Deleting Folders in the USB External Hard Disk Drive .....	86
Formatting the USB External Hard Disk Drive .....	86
Creating a Disc Using a Connected Blu-ray Recorder .....	87
Dubbing Files to a DVD Recorder or VCR .....	87
Copying to Windows PC .....	88
Verifying System Requirements (Guideline) .....	88
Installing the Provided Software .....	88
Backing Up All Files .....	89
Organizing Files .....	90
Recording Videos to Discs .....	91
JVC Software Licence Agreement .....	92
Backing Up Files Without Using Provided Software .....	93
List of Files and Folders .....	94
Copying to Mac Computer .....	94

## Menu Settings

Operating the Menu .....	96
Recording Menu (Video) .....	97
FACE PRIORITY AE/AF .....	98
LIGHT (GZ-HM350/GZ-HM330) .....	98
REGISTER EVENT .....	99
VIDEO QUALITY .....	99
ZOOM .....	99
GAIN UP .....	100
TIME-LAPSE RECORDING .....	100
AUTO REC .....	100
SEAMLESS RECORDING .....	101
x.v.Color .....	101
WIND CUT .....	102
Recording Menu (Still Image) .....	103
FACE PRIORITY AE/AF .....	103
LIGHT (GZ-HM350/GZ-HM330) .....	104
SELF-TIMER .....	104
SHUTTER MODE .....	105
IMAGE SIZE .....	105
IMAGE QUALITY .....	106
GAIN UP .....	106
AUTO REC .....	106
Manual Settings Menu .....	107
SCENE SELECT .....	107
FOCUS .....	107
FOCUS ASSIST .....	107
BRIGHTNESS ADJUST .....	107
SHUTTER SPEED (GZ-HM350/GZ-HM330) .....	107
WHITE BALANCE .....	107
BACKLIGHT COMP. ....	107
METERING AREA/TYPE .....	107
EFFECT .....	107
TELE MACRO .....	107
Playback Menu (Video) .....	108
DELETE .....	109
PICTURE TITLE (GZ-HM350/GZ-HM330) .....	109
SEARCH .....	109
PLAYBACK PLAYLIST .....	109
EDIT PLAYLIST .....	109
PLAYBACK OTHER FILE .....	109
EDIT .....	110
SEAMLESS REC CTRL .....	110
WIPE/FADER .....	110
ON-SCREEN DISPLAY .....	111
Playback Menu (Still Image) .....	112
DELETE .....	112
SEARCH DATE .....	112

EDIT .....	112
SLIDE SHOW EFFECTS .....	113
ON-SCREEN DISPLAY .....	113
Display Settings Menu .....	114
LANGUAGE .....	114
DATE DISPLAY STYLE .....	114
MONITOR BRIGHTNESS .....	115
LCD BACKLIGHT .....	116
FOCUS ASSIST COLOR .....	116
CLOCK ADJUST .....	117
Basic Settings Menu .....	118
DEMO MODE .....	119
AUTO POWER OFF .....	119
OPERATION SOUND .....	120
RECORD BUTTON .....	120
QUICK RESTART .....	121
REMOTE (GZ-HM350/GZ-HM330) .....	121
AUTO FINALIZE (GZ-HM350/GZ-HM330) .....	122
UPDATE .....	122
FACTORY PRESET .....	123
Connection Settings Menu .....	124
DISPLAY ON TV .....	124
VIDEO OUTPUT .....	124
COMPONENT OUTPUT .....	125
HDMI OUTPUT .....	125
HDMI CONTROL .....	126
Media Settings Menu .....	127
REC MEDIA FOR VIDEO (GZ-HM350/GZ-HM330) .....	127
VIDEO SLOT SELECTION (GZ-HM300) .....	127
REC MEDIA FOR IMAGE (GZ-HM350/GZ-HM330) .....	128
IMAGE SLOT SELECTION (GZ-HM300) .....	128
FORMAT BUILT-IN MEM. (GZ-HM350/GZ-HM330) .....	129
FORMAT SD CARD .....	129
ERASE ALL DATA (GZ-HM350/GZ-HM330) .....	130

## Names of Parts

Front .....	131
Rear .....	131
Bottom .....	132
Interior .....	132
LCD Monitor .....	133

## Indications on the LCD Monitor

Common Recording Indications .....	134
Video Recording .....	134
Still Image Recording .....	135
Video Playback .....	135
Still Image Playback .....	136

## Troubleshooting

Battery Pack .....	137
Recording .....	137
Card .....	138
Playback .....	138
Editing/Copying .....	139
PC .....	139
Screen/Image .....	140
Other Problems .....	140
Error Message? .....	141

## Maintenance

## Specifications

### Charging

- Refer to the operating instructions found in the animation on the Detailed User Guide.

### Recording

- Refer to the operating instructions found in the animation on the Detailed User Guide.

### Playback

- Refer to the operating instructions found in the animation on the Detailed User Guide.

### Shooting Tips

#### Basic Way to Hold a Camcorder ~ Recording Stable Images ~



This is the standard way of shooting while standing up. Be sure to master this basic technique in order to achieve stable images.

#### ■ [Getting Ready]

- ① Open your feet to the width of your shoulders.
- ② Keep the elbow of your right arm, which is holding the camcorder, close to your side.
- ③ Hold the LCD monitor with your left hand and adjust the angle accordingly.

#### Extending Your Hands to Shoot ~ High-Angle Shooting ~



Extend your hand when your subject is being hidden behind a crowd of people.

#### ■ [Getting Ready]

- ① Open your feet to the width of your shoulders.
- ② Extend your right hand and hold the camcorder over your head.
- ③ Hold the LCD monitor with your left hand and adjust the angle accordingly.

#### CAUTION:

- Use this way of shooting only as a last resort as it is difficult to achieve stable images.
- Set to the wide angle as much as possible as the image will be prone to camera shake.
- Be considerate. Do not inconvenience the people around you.

#### Squatting and Shooting at Eye Level



Staying low is a common position to take when shooting small children. By recording from the eye level of the child, you can capture all his cute expressions clearly.

#### ■ [Getting Ready]

- ① Kneel down with your left knee while keeping your right foot on the ground.
- ② Place the elbow of your right arm, which is holding the camcorder, on your right knee.
- ③ Hold the LCD monitor with your left hand and adjust the angle accordingly.

#### Panning

- Refer to the operating instructions found in the animation on the Detailed User Guide.  
Use this method to shoot a wide angle of view.

#### ■ [Getting Ready]

- ① Shoot by rotating your body instead of moving your arms while keeping the basic way of holding a camcorder as stated above.
- ② Stand facing the direction where the rotation will stop.
- ③ Twist your upper body to the direction where recording will start.
- ④ Press the start button and record for 2 seconds, then slowly twist back your body to face the front.  
Record for another 2 seconds while facing the front, then press the stop button.  
(The 90 degrees rotation should take about 5 seconds, giving the feeling of a slow motion.)

### Holiday Season/Christmas

Record the happy Christmas celebration with your family!





Photo by 101st CAB, Wings of Destiny  
[Creative Commons Attribution-No Derivative Works 3.0](#)

### Decorating the Tree and Preparing the Dinner

The decoration of tree and preparation of dinner are part of the joy of Christmas. Be sure to record these happy family times!

#### ■ Decorating the tree



A tree is the most important thing to bring out the mood of Christmas. Simply the scene of all family members engaging in the decorating of a fir tree with various colorful ornaments is full of the feeling of happiness.

#### ■ Preparing the Dinner



Photo by Manicosity  
[Creative Commons Attribution-No Derivative Works 3.0](#)  
 Record the scenes as everyone helps to prepare the feast of the night. You can film the mother who is cooking, the children who are helping, and of course, the process of making a cake!

### Recording the Christmas Party



Photo by InnerSpirit  
[Creative Commons Attribution-No Derivative Works 3.0](#)  
 After all preparations, it is finally the Christmas party itself. Not only should you record the candle-blowing scene, but also the smiles of the family while being surrounded by good food, or even the father who is slightly drunk from champagne!

### Finding the Presents



For children, the greatest joy of Christmas is receiving presents the next morning. Their expression of delight when finding a present next to their pillow is a recording opportunity not to be missed. Get ready to shoot before the children wake up!

## Wedding

Create an awesome wedding video for the bride and groom!



### Discussing and Planning Before the Event

Before the day of the wedding reception, it is important to discuss with the bride and groom about various details such as the order of the ceremony and whether there are any entertainment programs or change of clothes.

By understanding the preferences of the bride and groom, you will be able to shoot more appropriately.

### Finding the Right Angle to Capture Both Bride and Groom

- Composing the picture with the guests in front and the bride and groom at the back



The main characters of a wedding are of course the bride and groom. Record their expressions clearly during the toast, speech, entertainment programs, and other scenes.

Another recommendation is to capture the face shots of the guests, then pan towards the groom. Picture composition containing the crowd of guests only lacks fun, so be sure to pay attention to the shooting angle and size.

### Recording the Expressions and Comments of Guests

#### ■ Setting the shot from eye level to chest level



You can record comments from the guest by going around asking, "Please say a few words for the bride and groom".

This can be done at the guests' waiting room, when the bride and groom are changing, or during the entertainment programs.

### Closing Up on the Bride's Face During the Thank You Speech

The climax of the event finally comes during the bride and groom's thank you speech and presentation of flowers. The touching words of appreciation from the bride and tears of joy from the parents are scenes that must not be missed.

Start by closing up on the bride's face using zoom. As the tears start to form in the bride's eyes, continue shooting for a little longer. Then, slowly zoom out to the wide angle to show the parents who are moved by the speech.

### Advanced Operation with Two Camcorders

#### ■ <Camcorder 1> Closing up on the bride and groom all the time

#### ■ <Camcorder 2> Recording the congratulatory messages from friends at the same time



If video-editing is to be done, record using two camcorders so that a video with varying scenes can be created. You can try asking a close friend who has a camcorder at home.

Set the borrowed camcorder on a tripod to focus on taking close-up shots of the bride and groom. In this way, the other camcorder can be moved around to record other scenes, enabling an interesting video with changing scenes to be created through editing and compilation.

As most people own at least a digital camera nowadays, even if you are really unable to find an extra camcorder, inserting still pictures to the video at various points is also a good way to add variety. Do give it a try!

## Travel

Capture all the good times of your domestic or overseas trips!



### Bringing the Necessary Equipment

The necessary things to bring on a trip depends on your traveling purpose and the destination.

For overseas trips in particular, you have to think about what to bring in accordance to the local conditions.

Here are some suggestions for your consideration.

#### ■ Camcorder

Think about how many hours of shooting you will usually perform in a day. Be sure to prepare enough recording medium especially for long overseas trips.

If you are recording in SD cards, get ready the sufficient number of cards, including some for backup.

### ■ Battery Pack

Prepare a battery pack that is ready for double the expected recording time in a day. For example, if you plan to record for 2 hours a day, prepare a battery pack that is ready for 4 hours (actual recording time). For a day trip, you can prepare a battery with low capacity but for a long trip, do prepare a few batteries with high capacities.

### ■ AC Adapter

The JVC AC adapter supports voltages from 100 V to 240 V, and hence can be used anywhere in the world. Bring along the adapter if you are traveling for a long time. Charge the battery pack while sleeping so that you can record with full battery power the next day.

### ■ Power Plug Adapter

(P.18)



The shape of the power plug varies according to countries. Be sure to check the shape of the power plug beforehand, and bring the appropriate power plug adapter.

### ■ Battery Charger



Recording cannot be performed when an AC adapter is connected to the camcorder for battery charging. You can bring an additional battery charger to charge battery packs if you plan to use the camcorder for recording at night. You can also charge multiple battery packs by using both the battery charger and this camcorder at the same time.

### ■ Tripod



A tripod is an essential item to take stable images. Select an appropriate tripod in accordance to your purpose and style of traveling, such as a compact one to be used on a table or one that is at least 1 m tall.

### Recording the Excitement Before Departure

It may be a little abrupt to start your travel video at the destination suddenly.

Record also the preparations prior to departure if it is a family trip, or the time when everyone is gathered at the meeting place if you are traveling with your friends.

For overseas trips, taking a shot of the signs and displays at the airport of the flight you are taking may be useful for future reference.





### Using Pan at the Places of Interest

Tourists spots with beautiful scenery or historical sites are places that you would certainly want to record.

To capture the magnificence of a scene which cannot be fitted into a single frame, try the panning technique.

Refer to the "Shooting Tips" found in this website on how to use panning effectively.

In addition, you may also like to take a shot of the signs or monuments that can often be found at the tourist spots.



### Showing Everyone Having a Good Time

When taking a video, it is rather dull to shoot only the scenery or historical sites.

Talk about your feelings while recording the breath-taking scenery of an attraction so that it will be an interesting scene to view later.

### Amusement Park

Take more shots of the smiling faces of everyone in the family!



### Taking Videos or Still Images According to the Attraction

You may choose to take videos all the time. However, you may want to take some still images too.

The following section explains the scenarios suitable for taking videos or still images.

#### ■ Scenarios suitable for taking videos



Scenarios with changes in body movement are suitable for taking videos. This includes situations where there are rapid changes in facial expressions or voices of surprise and delight.

\*Some amusement parks do not allow passengers to perform any recording. Be sure to check beforehand.

[Examples]

- Merry-go-round, go kart, coffee cup, etc.

#### ■ Scenarios suitable for taking still images (photos)



Scenarios with little movement of the subject are suitable for taking still images.

Try to take the still images from an angle such that the surroundings can be seen clearly.

[Examples]

- Carousel, ferris wheel, fun bicycle rides, etc.

### Inducing Responses by Calling Out



Videos with no waving of hands nor laughter are not only dull when you view them later, but also put the capability of the audio-recording function of the camcorder to a waste.

When recording, induce more reactions by enthusiastically waving your hands or shouting out "Is it fun?" and the like.

### Capturing the Best Moment in a Video as a Still Image

Shots with the eyes closed are often taken by accident. To reduce such mistakes, make use of the function to capture still images from videos.

As videos are actually continuous recording of 60 still images within 1 minute, using this function allows you to select the best moment and save it as a still image.

"Capturing a Still Image in the Video during Playback" (P.59)



Photo by justthatgoodguyjim  
[Creative Commons Attribution-No Derivative Works 3.0](#)  
 Video Playback in Progress



Photo by talkrhubarb  
[Creative Commons Attribution-No Derivative Works 3.0](#)  
 Capturing a Still Image



Photo by justthatgoodguyjim  
[Creative Commons Attribution-No Derivative Works 3.0](#)  
 Video Playback in Progress

### Advanced Operation with Backlight Compensation

It is useful to make use of backlight compensation when the subject's face is in backlight or when the expression cannot be seen clearly. Increase the brightness of the whole image by setting "BACKLIGHT COMP." if the faces appear too dark. Even the expressions of faces under shadows can be captured brightly and clearly. "Setting Backlight Compensation" (P.30)

#### ■ <Without backlight compensation>









#### ■ <With backlight compensation>

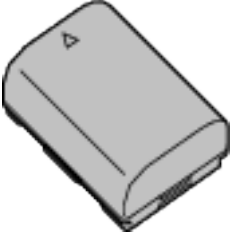
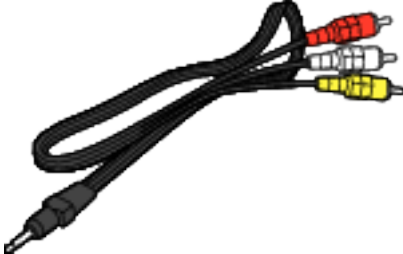
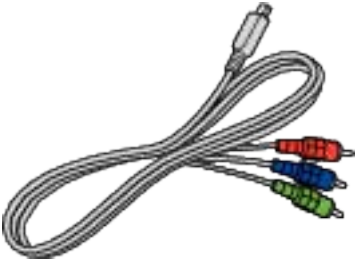

## Verifying the Accessories

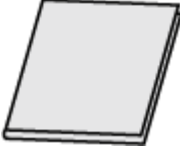
If any of the items are missing or defective, consult your JVC dealer or the nearest JVC service center.

Illustration	Description
	AC Adapter AP-V30M <ul style="list-style-type: none"> <li>• Connects to this unit to charge the battery pack. It can also be used when recording indoors or during playback.</li> </ul>
	Power Cord
	Battery Pack BN-VG114E <ul style="list-style-type: none"> <li>• Attaches to this unit to supply power.</li> </ul>
	AV Cable <ul style="list-style-type: none"> <li>• Connects this unit to a TV to play back recorded images on the TV.</li> </ul>
	Component Cable (GZ-HM350/GZ-HM330) <ul style="list-style-type: none"> <li>• Connects this unit to a TV to play back recorded images on the TV in a better quality.</li> </ul>
	USB Cable (A Type - Mini B Type) <ul style="list-style-type: none"> <li>• Connects this unit to a PC.</li> </ul>
	CD-ROM <ul style="list-style-type: none"> <li>• For installing the provided software "Everio MediaBrowser" on a PC.</li> </ul>
	Basic User Guide <ul style="list-style-type: none"> <li>• Read well and keep in a safe place where it can be accessed easily when necessary.</li> </ul>
	Remote Control (GZ-HM350/GZ-HM330) RM-V760 <ul style="list-style-type: none"> <li>• Operates certain functions from a distance.</li> </ul>

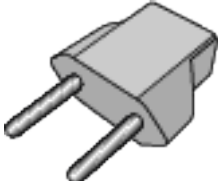
	
	<p>Lens Cap (GZ-HM300)</p> <ul style="list-style-type: none"> <li>• Protects the lens.</li> </ul>
	<p>Plug Adapter (certain AS destinations only)</p>

**Memo:**

- SD cards are sold separately.
- "Types of Usable SD Card" (P.13)
- When using the AC adapter overseas, please prepare a commercially available converter plug for the country or region of visit.
- "Charging the Battery Pack Overseas" (P.18)

## Charging the Battery Pack

Charge the battery pack immediately after purchase and when the remaining battery power is low. The battery pack is not charged at the time of purchase.

### 1 Attach the battery pack.

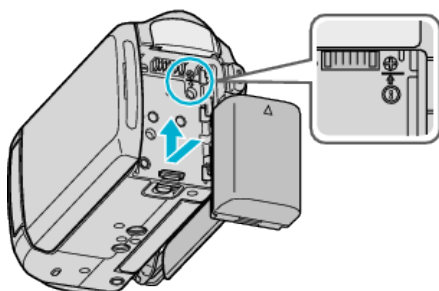

- Align the top of the battery with this unit, and slide in until the battery clicks into place.

### 2 Connect the AC adapter to the DC terminal.

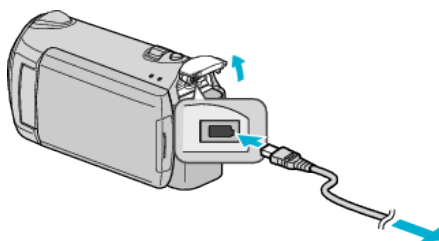

### 3 Plug in the power.

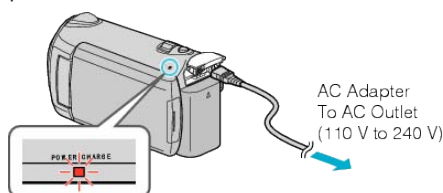

- The charging lamp blinks when charging is in progress. It goes out when charging is finished.

**CAUTION:**

- If you use any other battery packs besides JVC battery packs, safety and performance can not be guaranteed.
- Charging time: Approx. 2 h 30 m (using supplied battery pack) The charging time is when the unit is used at 25°C.

If the battery pack is charged outside the room temperature range of 10°C - 35°C, charging may take a longer time or it may not start. The recordable and playable time may also be shortened under some usage conditions such as at low temperature.

**Rechargeable Batteries :**

- When using the battery in a low temperature environment (10°C or below), the operating time may be shortened, or it may not function properly. When using this unit outdoors in the winter weather, warm the battery, such as by placing it in the pocket, before attaching it. (Keep away from direct contact with a warm pack.)
- Do not expose the battery to excessive heat, such as direct sunlight or fire.
- If the battery pack is not to be used for a long time, use up the charge completely and detach it from this unit to prevent deterioration.
- After removing the battery, store it in a dry place between 15°C to 25°C.
- Battery deterioration occurs when a battery pack is charged repeatedly. Replace the battery pack with a new one.

**Memo:**

- You can connect this unit to the AC adapter to record for long hours indoors. (Battery charging begins when the LCD monitor is closed.)
- Please do not pull or bend the AC adapter plug and cable. This may damage the AC adapter.

## Detaching the Battery Pack

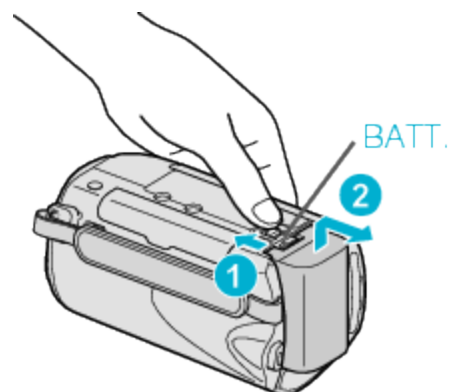

Slide the battery release lever to detach the battery from this unit.

Approximate Battery Charging Time

Battery Pack	Charging Time	Actual Recording Time (GZ-HM350/GZ-HM330)	Actual Recording Time (GZ-HM300)	Continuous Recording Time (GZ-HM350/GZ-HM330)	Continuous Recording Time (GZ-HM300)
BN-VG114E (Supplied)	2 h 30 m	55 m	1 h	1 h 40 m	1 h 45 m
BN-VG121E	3 h 30 m	1 h 25 m	1 h 30 m	2 h 30 m	2 h 40 m

\*The above are values when "LIGHT" is set to "OFF" and "LCD BACK-LIGHT" is set to "STANDARD".

Battery Pack	Charging Time	Actual Recording Time (GZ-HM350/GZ-HM330)	Actual Recording Time (GZ-HM300)	Continuous Recording Time (GZ-HM350/GZ-HM330)	Continuous Recording Time (GZ-HM300)
BN-VG114E (Supplied)	2 h 30 m	50 m	50 m	1 h 30 m	1 h 35 m
BN-VG121E	3 h 30 m	1 h 15 m	1 h 20 m	2 h 20 m	2 h 25 m

\*The above are values when "LIGHT" is set to "OFF" and "LCD BACK-LIGHT" is set to "BRIGHTER".

- When the battery life is reached, the recording time becomes shorter even if the battery pack is fully charged. (Replace the battery pack with a new one.)

Grip Adjustment



- ① Flip the grip belt over.
- ② Adjust the length of the belt.
- ③ Fasten the grip belt.

CAUTION:

- Be sure to fasten the grip belt properly. If the belt is loose, this unit may drop and result in injuries or damages.

Using the Hand Strap

When using the hand strap, loop it around your wrist.

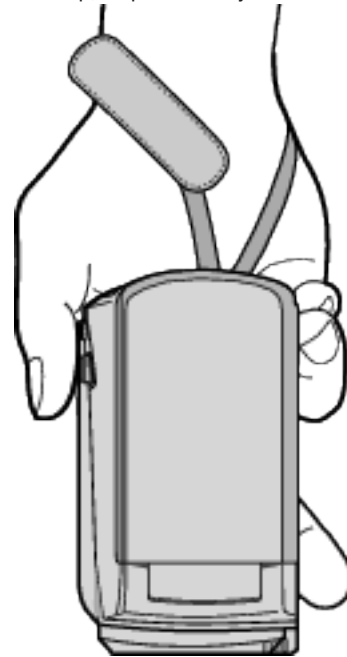

Removing the Strap

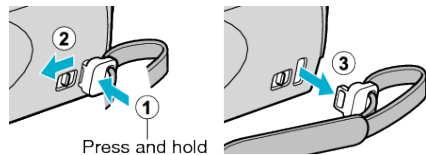

- While pressing ①, pull ② and remove the strap.

Attaching the Strap

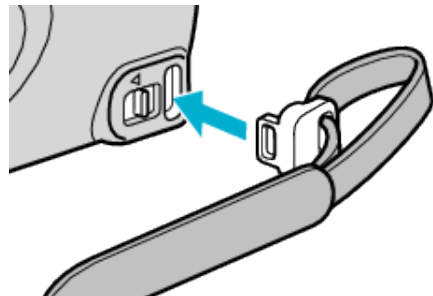

- Push in firmly until it clicks into place.

## Inserting an SD Card (GZ-HM350/GZ-HM330)

When a commercially available SD card is inserted, recordings can still be made to the card without stopping when the remaining recording time on the internal memory runs out.

"Types of Usable SD Card" (P.13)

1 Press the power button for more than 2 seconds to turn off this unit.

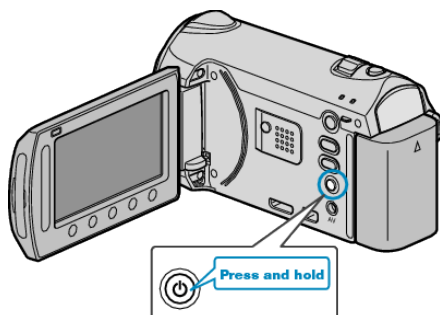

2 Open the card slot cover.

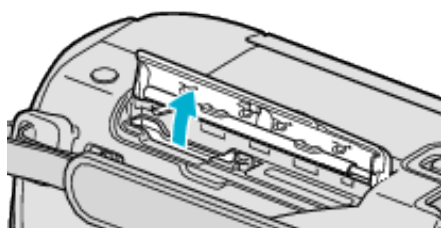

3 Insert an SD card.

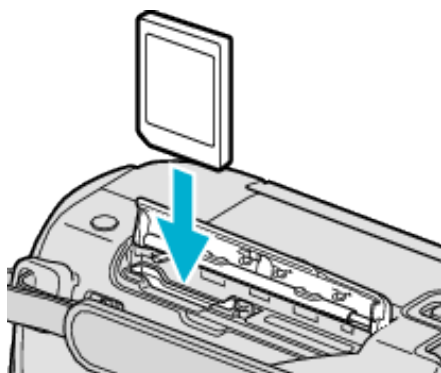

### CAUTION:

- Make sure not to insert the card in the wrong direction. It may cause damage to the unit and card.
- Turn off the power of this unit before inserting or removing a card.

### Memo:

- Recording switches automatically from one media to another and vice versa after the card or memory space in the selected media is full.

"SEAMLESS RECORDING" (P.101)

- To record to the card, it is necessary to adjust media settings. When no card is available, set media settings to "BUILT-IN MEMORY" for recording.

"REC MEDIA FOR VIDEO (GZ-HM350/GZ-HM330)" (P.127)

"REC MEDIA FOR IMAGE (GZ-HM350/GZ-HM330)" (P.128)

- To use cards that have been used on other devices, it is necessary to format (initialize) the card using "FORMAT SD CARD" from media settings.

"FORMAT SD CARD" (P.129)

### Removing the Card

Push the card inward once, then pull it out straight.

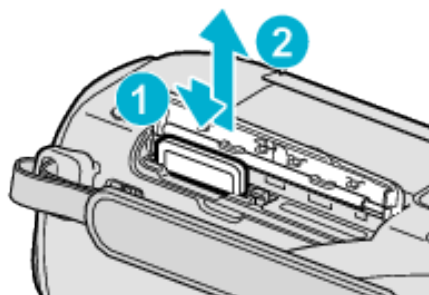

### Types of Usable SD Card

The following SD cards can be used on this unit.

#### SDHC Card



- Use a Class 4 or higher compatible SDHC card (4 GB to 32 GB) for video recording.

#### SD Card



- This unit supports 256 MB to 2 GB SD cards. Operations are confirmed on the SD cards from the following manufacturers.

- Panasonic
- TOSHIBA
- SanDisk
- ATP

### Memo:

- Using SD cards (including SDHC cards) other than those specified above may result in recording failure or data loss.
- Class 4 and Class 6 are guaranteed to have a minimum transfer rate of 4 MB/s and 6 MB/s respectively during reading or writing of data.

## Inserting an SD Card (GZ-HM300)

Insert a commercially available SD card before recording. This unit comes with two SD card slots. When two SD cards are inserted, recordings can be continued on the other card even if one card is full. "Types of Usable SD Card" (P.13)

1 Press the power button for more than 2 seconds to turn off this unit.

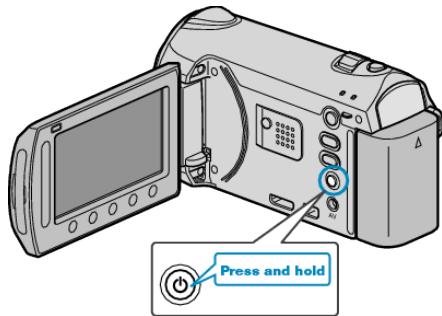

2 Open the card slot cover.

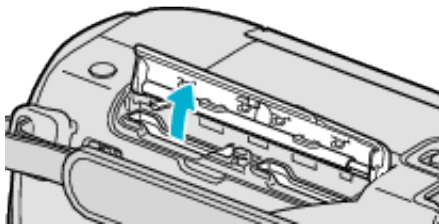

3 Insert an SD card into slot A.

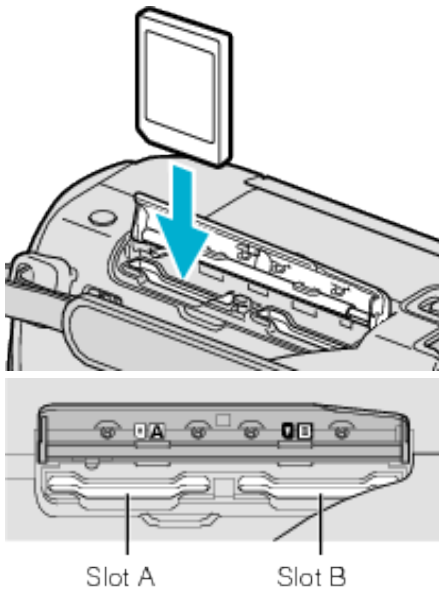

### CAUTION:

- Make sure not to insert the card in the wrong direction. It may cause damage to the unit and card.
- Turn off the power of this unit before inserting or removing a card.

### Memo:

- Recording switches automatically from one card to another and vice versa after the selected card is full.

"SEAMLESS RECORDING" (P.101)

- To record to the card, it is necessary to adjust media settings.

"VIDEO SLOT SELECTION (GZ-HM300)" (P.127)

"IMAGE SLOT SELECTION (GZ-HM300)" (P.128)

- To use cards that have been used on other devices, it is necessary to format (initialize) the card using "FORMAT SD CARD" from media settings.

"FORMAT SD CARD" (P.129)

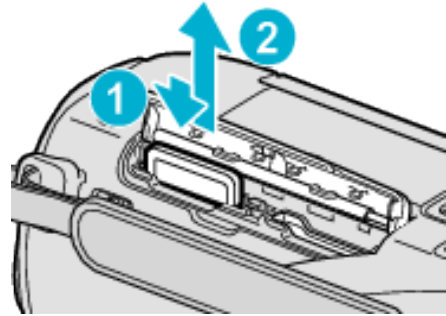

## Types of Usable SD Card

The following SD cards can be used on this unit.

### SDHC Card



- Use a Class 4 or higher compatible SDHC card (4 GB to 32 GB) for video recording.

### SD Card



- This unit supports 256 MB to 2 GB SD cards. Operations are confirmed on the SD cards from the following manufacturers.

- Panasonic
- TOSHIBA
- SanDisk
- ATP

### Memo:

- Using SD cards (including SDHC cards) other than those specified above may result in recording failure or data loss.
- Class 4 and Class 6 are guaranteed to have a minimum transfer rate of 4 MB/s and 6 MB/s respectively during reading or writing of data.

## Removing the Card

Push the card inward once, then pull it out straight.



## Clock Setting

The "SET DATE/TIME!" screen appears when you turn on this unit for the first time after purchase, when it has not been used for a long time, or when the clock is not set yet.  
Set the clock before recording.

1 Open the LCD monitor.

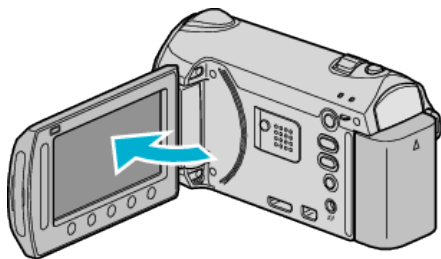

- This unit turns on.
- When the LCD monitor is closed, this unit turns off.

2 Select "YES" and touch **OK**.



3 Set the date and time.



- Use the slider to adjust the year, month, day, hour, and minute in order.
- Touch the operation buttons "←" / "→" to move the cursor.
- After setting the date and time, touch **OK**.

4 Select the region where you live and touch **OK**.



- The city name and time difference are displayed.
- Touch **OK** after the color of the selected region changes.

**Memo:**

- The clock can be reset again later.
- "Resetting the Clock" (P.15)
- When using this unit overseas, you can set it to the local time for recording.
- "Setting the Clock to Local Time when Traveling" (P.19)
- "SET DATE/TIME!" is displayed when you turn on this unit after it has not been used for a prolonged period.  
Charge this unit for more than 24 hours before setting the clock.
- "Charging the Battery Pack" (P.11)
- You can turn on or off the clock display during playback mode.
- "ON-SCREEN DISPLAY" (P.111)
- The clock set style of this unit varies with the models.
- "Clock Set Style" (P.115)

- Touch the slider and buttons around the screen with your fingers.
- The slider and buttons do not function if you touch them with your fingernails or with gloves on.
- The displays on the screen do not work even if you touch them.

## Resetting the Clock

Set the clock with "CLOCK ADJUST" from the menu.

1 Touch **MENU** to display the menu.

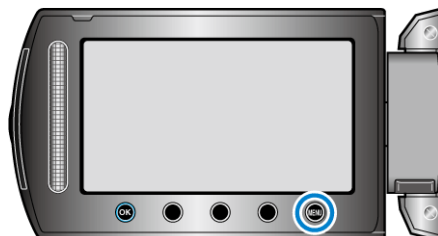

2 Select "CLOCK ADJUST" and touch **OK**.



3 Select "CLOCK SETTING" and touch **OK**.



4 Set the date and time.



- Use the slider to adjust the year, month, day, hour, and minute in order.
- Touch the operation buttons "←" / "→" to move the cursor.
- After setting the date and time, touch **OK**.

5 Select the region where you live and touch **OK**.



- The city name and time difference are displayed.
- Touch **OK** after the color of the selected region changes.

### Using the Operation Buttons

Functions of the operation buttons may be displayed on the screen according to the feature in use.

Functions of the operation buttons will be displayed.

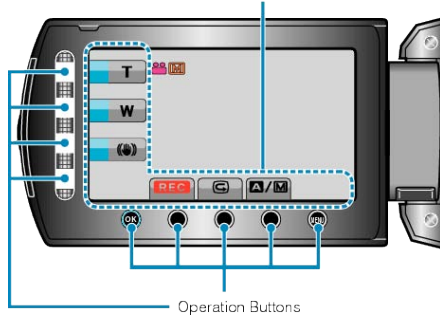

- To operate, touch the slider and buttons around the screen lightly with your fingers.

#### Memo:

- "Touch" denotes the touching of the operation buttons lightly.
- The slider and buttons do not function if you touch them with your fingernails or with gloves on.
- The displays on the screen do not work even if you touch them.

### Using the Slider

Slide the ball of your finger along the slider for smooth operations. While the slider is being pressed, the cursor moves automatically. Fine operations such as moving the cursor one by one can be performed by touching the slider.

- Refer to the operating instructions found in the animation on the Detailed User Guide.

#### Memo:

- The slider and buttons do not function if you touch them with your fingernails or with gloves on.
- The displays on the screen do not work even if you touch them.

### Holding this Unit

When holding this unit, keep your elbows close to your sides to prevent camera shake.



#### CAUTION:

- Be careful not to drop this unit during transportation.

- Guardians should pay close attention when this unit is being used by children.

#### Memo:

- If camera shake is excessive, use the digital image stabilizer.

"Reducing Camera Shake" (P.23)

## Using the Remote Control (GZ-HM350/GZ-HM330)

You can operate this unit from a distance away using the supplied remote control. (GZ-HM350/GZ-HM330 only)

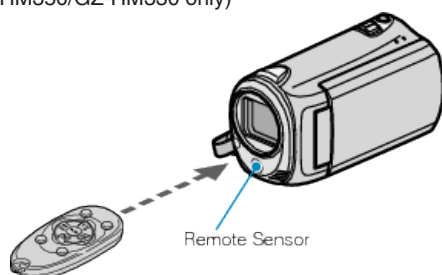

### Memo:

- Point the remote control toward the sensor directly and use it within 5 m from this unit.
- The transmitted beam may not be effective or may cause incorrect operation when the sensor is directly exposed to sunlight or powerful lighting.

## Preparing the Remote Control

### Using the Remote Control for the First Time

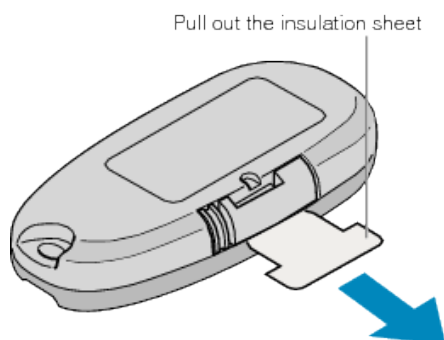

- A button battery (CR2025) is included inside the remote control at the time of purchase. Remove the insulation sheet before use.

### Reinserting the Battery

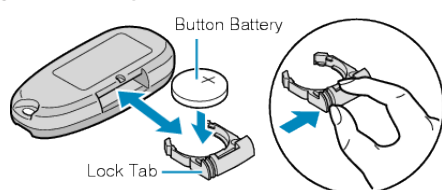

- Pull out the battery holder by pressing the lock tab.
- Insert the button battery with the + side facing upward.

## Operation Buttons on Remote Control Unit

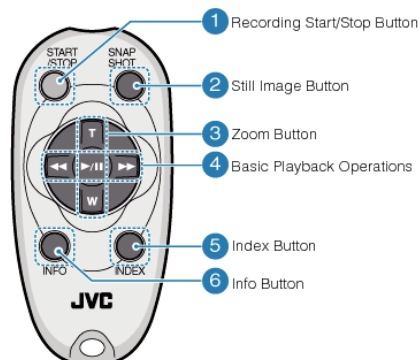

### 1 Recording Start/Stop Button

- Starts/stops video recording.

### 2 Still Image Button

- Takes a still image.

### 3 Zoom Button

- T: Zooms in
- W: Zooms out

### 4 Basic Playback Operations

Operation Button	Description
Playback/Pause Button ▶ /	<ul style="list-style-type: none"> <li>• Starts/pauses playback of videos or slide-shows.</li> </ul>
Left Button ◀◀	<ul style="list-style-type: none"> <li>• Moves the cursor to the left.</li> <li>• Performs reverse search during playback.</li> </ul>
Right Button ▶▶	<ul style="list-style-type: none"> <li>• Moves the cursor to the right.</li> <li>• Performs forward search during playback.</li> </ul>
T Button T	<ul style="list-style-type: none"> <li>• Zooms in. (during pause)</li> <li>• Turns up (+) the volume during video playback.</li> </ul>
W Button W	<ul style="list-style-type: none"> <li>• Zooms out. (during pause)</li> <li>• Turns down (-) the volume during video playback.</li> </ul>

### 5 Index Button

- Stops playback and returns to thumbnail display.

### 6 Info Button

- Recording: Displays the remaining time (for video only) and battery power.
- Playback: Displays file information such as recording date.

## Attaching the Lens Cap (GZ-HM300)

To protect the lens, attach the provided lens cap to this unit as shown in the illustration.

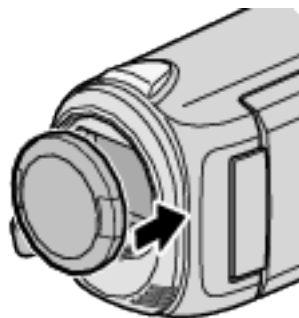

### CAUTION:

- Please be careful not to lose the lens cap.

## Tripod Mounting

This unit can be mounted on a tripod. This is useful for preventing camera shake and recording from the same position.

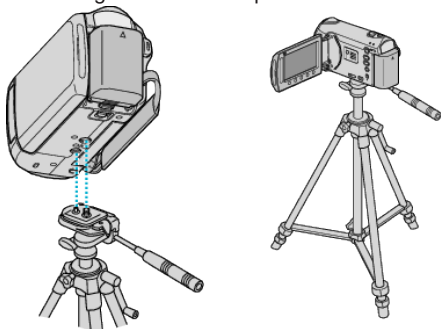

- To prevent this unit from falling off, check the tripod mounting screw holes and positioning holes on the unit carefully before mounting, and turn the screws until they are fastened firmly.

### CAUTION:

- To prevent injuries or damages which may result if this unit falls off, read the instruction manual of the tripod to be used and make sure that it is securely attached.

### Memo:

- It is recommended to use the tripod when recording in conditions prone to camera shake (such as in dark places or when zoomed to the telephoto end).
- Set the digital image stabilizer to (OFF) when using a tripod for recording.

"Reducing Camera Shake" (P.23)

## Using this Unit Overseas

The shape of the power outlet varies according to countries and regions. To charge the battery pack, you need a converter plug that matches the shape of the outlet.

"Charging the Battery Pack Overseas" (P.18)

Change the date and time display to the local time by selecting your travel destination in "AREA SETTING" or "CLOCK ADJUST".

"Setting the Clock to Local Time when Traveling" (P.19)

When "ON" is selected in "SET FOR DAYLIGHT SAVING TIME" or "CLOCK ADJUST", the time is set 1 hour ahead.

"Setting Daylight Saving Time" (P.19)

## Charging the Battery Pack Overseas

The shape of the power outlet varies according to countries and regions. To charge the battery pack, you need a converter plug that matches the shape of the outlet.

A	B	BF	C	O

North America	Europe	Oceania	Middle East
United States A	Iceland C	Australia O	Israel C
Canada A	Ireland C	Guam A	Iran C
Mexico A	United Kingdom B, BF	Tahiti C	Kuwait B, C
Asia	Italy C	Tonga O	Jordan B, BF
India B, C, BF, C	Austria C	New Zealand O	Africa
Indonesia C	Netherlands C	Fiji O	Algeria A, B, BF, C
Singapore B, BF	Canary Islands C	Latin	
Sri Lanka B, C, BF	Greece C	Argentina O	Egypt B, BF, C
Thailand A, BF, C	Switzerland C	Colombia A	Guinea C
South Korea A, C	Sweden C	Costa Rica A	Kenya B, C
China A, B, BF, C, O	Spain A, C	Jamaica A	Zambia B, BF
Japan A	Denmark C	Chile B, C	Tanzania B, BF
Nepal C	Germany C	Haiti A	Republic of South Africa B, C, BF
Pakistan B, C	Norway C	Panama A	Mozambique C
Bangladesh C	Hungary C	Bahamas A	Morocco C
Philippines A, BF, O	Finland C	Puerto Rico A	
Vietnam A, C	France C	Brazil A, C	
Hong Kong Special	Belgium C	Venezuela A	
Administrative Region B, BF	Poland B, C	Peru A, C	
Macau Special	Portugal B, C		
Administrative Region B, C	Romania C		
Malaysia B, BF, C			

### Setting the Clock to Local Time when Traveling

Change the date and time display to the local time by selecting your travel destination in "AREA SETTING" of "CLOCK ADJUST". Restore the region settings after you returned from the trip.

1 Touch **MENU** to display the menu.

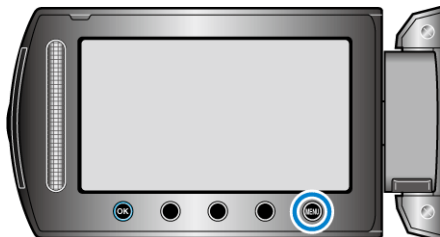

2 Select "CLOCK ADJUST" and touch **OK**.



3 Select "AREA SETTING" and touch **OK**.



4 Select the area you are traveling to and touch **OK**.



- The city name and time difference are displayed.

**Memo:**—  
 • Setting "AREA SETTING" changes the clock time such that time difference is accounted for.  
 After returning to your country, re-select the region that was set initially to restore the original clock settings.

### Setting Daylight Saving Time

When "ON" is selected in "SET FOR DAYLIGHT SAVING TIME" of "CLOCK ADJUST", the time is set 1 hour ahead.

1 Touch **MENU** to display the menu.

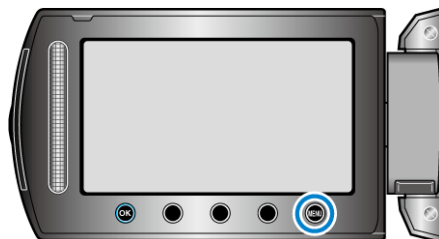

2 Select "CLOCK ADJUST" and touch **OK**.



3 Select "SET FOR DAYLIGHT SAVING TIME" and touch **OK**.



4 Set daylight saving time and touch **OK**.



**Memo:**—  
 • What is daylight saving time?  
 Daylight saving time is the system of setting the clock 1 hour ahead for a fixed period in summer. It is used mainly in the Western countries.  
 • Restore the daylight saving time settings after you returned from the trip.



## Optional Accessories

Product Name	Description				
<b>Battery Pack</b> <ul style="list-style-type: none"> <li>BN-VG114E</li> <li>BN-VG121E</li> </ul>	<ul style="list-style-type: none"> <li>Provides a longer recording time than the battery pack that comes with this unit. It can also be used as a spare battery pack.</li> </ul>				
<b>Battery Charger</b> <ul style="list-style-type: none"> <li>AA-VG1</li> </ul>	<ul style="list-style-type: none"> <li>Enables the battery pack to be charged without using this unit.</li> </ul>				
<b>DVD Writer</b> <ul style="list-style-type: none"> <li>CU-VD3 (GZ-HM350/GZ-HM330)</li> </ul>	<ul style="list-style-type: none"> <li>Enables the images recorded on this unit to be copied to a DVD without using a PC.</li> </ul>				
<b>DVD Writer</b> <ul style="list-style-type: none"> <li>CU-VD50 (GZ-HM350/GZ-HM330)</li> </ul>	<ul style="list-style-type: none"> <li>Creates DVDs and functions as an external DVD drive when connected to a PC. In addition, created DVDs can be played back by connecting the CU-VD50 to a TV.</li> </ul>				
<b>Component Cable</b> <ul style="list-style-type: none"> <li>QAM1266-001</li> </ul>	<ul style="list-style-type: none"> <li>For viewing in high picture quality.</li> </ul>				
<b>USB Cable</b> <ul style="list-style-type: none"> <li>QAM0852-001 (GZ-HM350/GZ-HM330)</li> </ul> <table border="1" data-bbox="288 860 695 943"> <tbody> <tr> <td>Seagate</td> <td>FreeAgent™ Desk series</td> </tr> <tr> <td>LaCie</td> <td>Design by Neil Poulton series</td> </tr> </tbody> </table>	Seagate	FreeAgent™ Desk series	LaCie	Design by Neil Poulton series	<ul style="list-style-type: none"> <li>Connects this unit to a BD writer or a recommended USB external hard disk drive (see table below).</li> </ul>
Seagate	FreeAgent™ Desk series				
LaCie	Design by Neil Poulton series				

**Memo:**

- For more information, refer to the catalog.
- BN-VG114E is the same battery pack that comes with this unit.

## Approximate Recording Time (Using Battery)

Battery Pack	Actual Recording Time (GZ-HM350/GZ-HM330)	Actual Recording Time (GZ-HM300)	Continuous Recording Time (GZ-HM350/GZ-HM330)	Continuous Recording Time (GZ-HM300)
<b>BN-VG114E (Supplied)</b>	55 m	1 h	1 h 40 m	1 h 45 m
<b>BN-VG121E</b>	1 h 25 m	1 h 30 m	2 h 30 m	2 h 40 m

- The above are values when "LIGHT" is set to "OFF" and "LCD BACK-LIGHT" is set to "STANDARD".
- The actual recording time may be shorter if zooming is used or if recording is stopped repeatedly. (It is recommended to prepare battery packs ready for three times the expected recording time.)
- When the battery life is reached, the recording time becomes shorter even if the battery pack is fully charged. (Replace the battery pack with a new one.)

## Taking Videos in Auto Mode

You can record without worrying about the setting details by using the auto mode.

- 1 Open the LCD monitor and select the video mode. (Open the lens cover for GZ-HM300.)

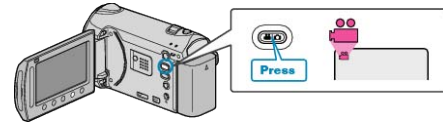

- The video mode icon appears.

- 2 Check if the recording mode is Auto.

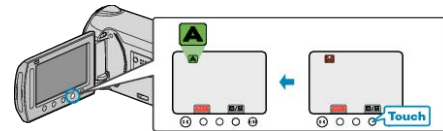

- If the mode is Manual, touch the **[A/M]** button. The mode changes between Auto and Manual with every touch.

- 3 Start recording.

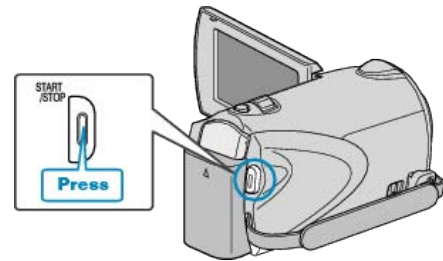

- Press again to stop.

## Indications During Video Recording

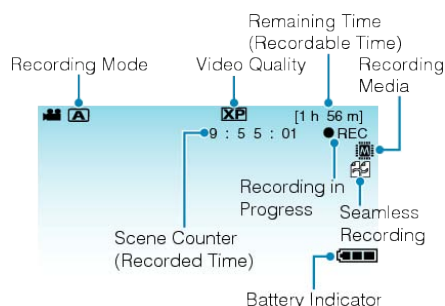

Display Icon	Description
<b>Recording Mode</b>	Press the <b>A/M</b> button to switch the recording mode between <b>A</b> (Auto) and <b>M</b> (Manual).
<b>Video Quality</b>	Displays the icon of the "VIDEO QUALITY" setting selected in the recording menu. "VIDEO QUALITY" (P.99)
<b>Remaining Time (Recordable Time)</b>	Displays the remaining time for video recording.
<b>● REC Recording in Progress</b>	Appears when video recording is in progress.
<b>●    Record-Stand-by</b>	Appears when video recording is paused.
<b>Scene Counter (Recorded Time)</b>	Displays the elapsed time of the video that is currently being recorded.
<b>Recording Media</b>	Displays the icon of the media where videos are recorded to. The recording media can be changed. "REC MEDIA FOR VIDEO (GZ-HM350/GZ-HM330)" (P.127) "VIDEO SLOT SELECTION (GZ-HM300)" (P.127)
<b>SEAMLESS RECORDING</b>	Automatically switches to a different media and continues recording when the remaining space on the current recording media runs out. For example, when the remaining space on the SD card runs out during recording, the recording continues on the built-in memory without stopping. "SEAMLESS RECORDING" (P.101)
<b>Battery Indicator</b>	Displays the approximate remaining battery power. Details of the battery power can be displayed by pressing the INFO button <b>ⓘ</b> . "Remaining Recording Time/Battery Power" (P.37)

## Operation Buttons for Video Recording

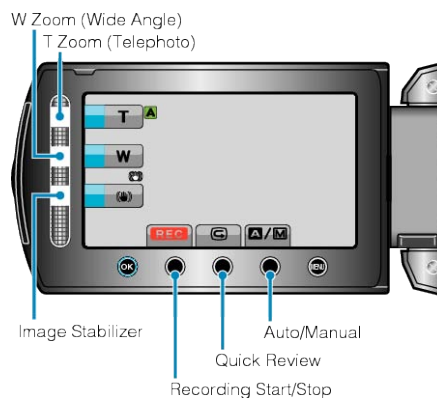

Operation Button	Description
<b>T/W Zoom</b>	Allows the same functions as the zoom lever to be performed. Camera shake that often occurs when using the zoom lever can be minimized. "Zooming" (P.22)
<b>Image Stabilizer</b>	Sets whether to reduce camera shake. "Reducing Camera Shake" (P.23)
<b>Recording Start/Stop</b>	Functions as the START/STOP button.
<b>Quick Review</b>	Enables the most recently captured video to be viewed. "Checking the Captured Image Immediately (Quick Review)" (P.23)
<b>Auto/Manual</b>	Switches the recording mode between Auto and Manual.

### Memo:

- The slider operation button cannot be used when the LCD monitor is flipped.
- The zoom appears when the slider is touched.

## Useful Settings for Recording

- Videos can be found easily during playback by categorizing them when recording.

"Registering Files to Events Before Recording" (P.32)

- When "QUICK RESTART" is set to "ON", this unit turns on immediately if you open the LCD monitor within 5 minutes after the power is turned off by closing the monitor.

"QUICK RESTART" (P.121)

- When "AUTO POWER OFF" is set to "ON", this unit turns itself off automatically to conserve power when it is not operated for 5 minutes. (only when using the battery pack)

"AUTO POWER OFF" (P.119)

- When "FACE PRIORITY AE/AF" is set to "ON" (default setting), this unit detects faces and automatically adjusts its brightness and focus to record the faces more clearly.

"FACE PRIORITY AE/AF" (P.98)

- If the remaining space on the recording media runs out while "SEAMLESS RECORDING" is set to "ON", recording continues after switching to another recording media.

"SEAMLESS RECORDING" (P.101)

### CAUTION:

- Do not expose the lens to direct sunlight.
- Do not use this unit in the rain, snow, or places with high humidity like the bathroom.
- Do not use this unit in places subject to excessive humidity or dust, as well as places exposed to steam or smoke directly.
- The access lamp lights up when video recording is in progress. Do not remove the battery pack, AC adapter, or SD card when the lamp is lighted.
- Make a backup of important recorded data.  
It is recommended to copy your important recorded data to a DVD or other recording media for storage. JVC will not be responsible for any lost data.

### Memo:

- Before recording an important scene, it is recommended to conduct a trial recording.
- Check the remaining recording time in the media before you start shooting. If there is not enough space, move (copy) the data to a PC or disc.
- Do not forget to make copies after recording!
- Recording stops automatically as it cannot be performed for 12 or more consecutive hours according to specifications. To ensure continuous recording, set "SEAMLESS RECORDING" to "ON" before you start recording.

"SEAMLESS RECORDING" (P.101)

- For long recordings, the file is split into two or more files if the size exceeds 4 GB.
- You can connect this unit to the AC adapter to record for long hours indoors.

## Zooming

The angle of view can be adjusted using zoom.

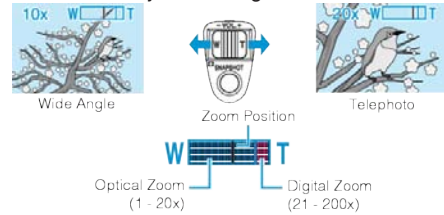

- Use the W end (wide angle end) to shoot a wider field of view.
- Use the T end (telephoto end) to magnify the subject for shooting.

### Memo:

- When digital zoom is used, the image becomes grainy as it is digitally enlarged.
- The zoom ratio range can be changed.

"Changing the Zoom Ratio Range" (P.99)

## Capturing Still Images During Video Recording

Still images can be captured by pressing the SNAPSHOT button while in the video mode (standby or recording).

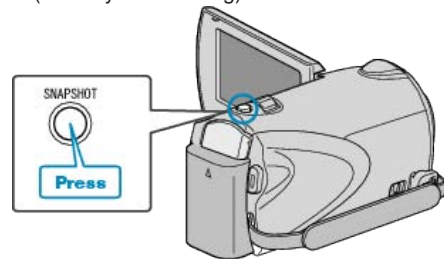

- "PHOTO" lights up on the screen when a still image is being captured.



- The still images captured during video recording are saved to the destination set in media settings.

"REC MEDIA FOR IMAGE (GZ-HM350/GZ-HM330)" (P.128)

"IMAGE SLOT SELECTION (GZ-HM300)" (P.128)

### Memo:

- The picture quality varies with the "IMAGE QUALITY" setting.

"Changing Still Image Picture Quality" (P.106)

## Reducing Camera Shake

When the digital image stabilizer is turned on, camera shake during recording can be effectively reduced.



- The setting of the image stabilizer switches with every touch.

Display	Setting
(Image stabilizer 1)	Reduces camera shake under normal shooting conditions.
(Image stabilizer 2)	Reduces camera shake more effectively when shooting bright scenes on the wide angle end. *Only on the wide angle end (approx. 5x)
(OFF)	Deactivates image stabilizer.

### Memo:

- It is recommended to switch off this mode when using a tripod and recording a subject with little movement.
- Complete stabilization may not be possible if camera shake is excessive.
- This setting is effective for video recording only.

## Checking the Captured Image Immediately

You can check the most recently captured images while in the recording mode. (Quick Review)



### Memo:

- You can also delete the image after checking.
- Quick Review can no longer recall the most recently captured image once the power is turned off. Use the playback mode to check the image in this case.

## Taking Still Images in Auto Mode

You can record without worrying about the setting details by using the auto mode.

- 1 Open the LCD monitor and select the still image mode. (Open the lens cover for GZ-HM300.)

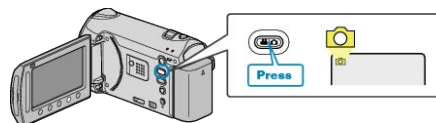

- The still image mode icon appears.

- 2 Check if the recording mode is Auto.

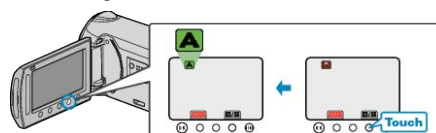

- If the mode is Manual, touch the button. The mode changes between Auto and Manual with every touch.

- 3 Set the focus on the subject.

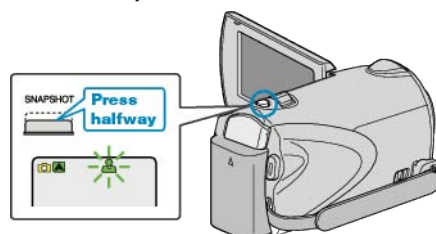

- When focused, the focus icon lights up in green.

- 4 Take a still image.

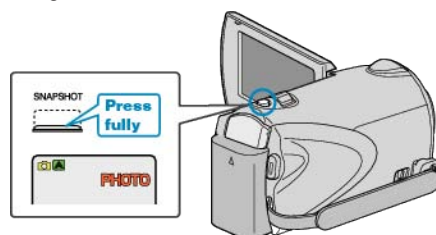

- PHOTO lights up when a still image is being captured.

## Indications During Still Image Recording

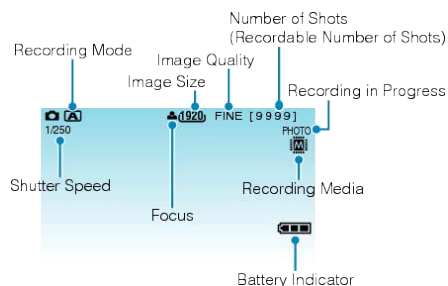

Display Icon	Description
<b>Recording Mode</b>	Press the <b>A/M</b> button to switch the recording mode between <b>A</b> (Auto) and <b>M</b> (Manual).
<b>Image Size</b>	Displays the icon of the image size. "IMAGE SIZE" (P.105)
<b>Image Quality</b>	Displays the icon of the "IMAGE QUALITY" setting selected in the recording menu. "IMAGE QUALITY" (P.106)
<b>Number of Shots (Recordable Number of Shots)</b>	Displays the remaining number of shots for still image recording.
<b>Shutter Speed</b>	Displays the shutter speed.
<b>Focus</b>	Lights up in green when focused.
<b>Recording in Progress</b>	Appears when a still image is being captured.
<b>Recording Media</b>	Displays the icon of the media where still images are recorded to. The recording media can be changed. "REC MEDIA FOR IMAGE (GZ-HM350/GZ-HM330)" (P.128) "IMAGE SLOT SELECTION (GZ-HM300)" (P.128)
<b>Battery Indicator</b>	Displays the approximate remaining battery power. Details of the battery power can be displayed by pressing the INFO button  "Remaining Recording Time/Battery Power" (P.37)



## Operation Buttons for Still Image Recording

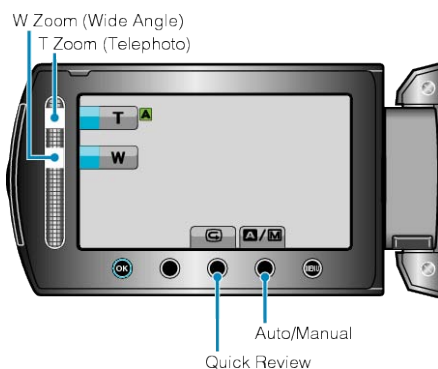

Operation Button	Description
<b>T/W Zoom</b>	Functions as the zoom lever. "Zooming" (P.25)
<b>Quick Review</b>	Enables the most recently captured still image to be viewed. "Checking the Captured Image Immediately" (P.25)
<b>Auto/Manual</b>	Switches the recording mode between Auto and Manual.

### Memo:

- The slider operation button cannot be used when the LCD monitor is flipped.
- The zoom appears when the slider is touched.

## Useful Settings for Recording

- When "QUICK RESTART" is set to "ON", this unit turns on immediately if you open the LCD monitor within 5 minutes after the power is turned off by closing the monitor.

"QUICK RESTART" (P.121)

- When "AUTO POWER OFF" is set to "ON", this unit turns itself off automatically to conserve power when it is not operated for 5 minutes. (only when using the battery pack)

"AUTO POWER OFF" (P.119)

- When "FACE PRIORITY AE/AF" is set to "ON" (default setting), this unit detects faces and automatically adjusts its brightness and focus to record the faces more clearly.

"FACE PRIORITY AE/AF" (P.103)

- The image resolution can be changed.

"IMAGE SIZE" (P.105)

### CAUTION:

- Do not expose the lens to direct sunlight.
- Do not use this unit in the rain, snow, or places with high humidity like the bathroom.
- Do not use this unit in places subject to excessive humidity or dust, as well as places exposed to steam or smoke directly.
- The access lamp lights up when still image recording is in progress. Do not remove the battery pack, AC adapter, or SD card when the lamp is lighted.

### Memo:

- Before recording an important scene, it is recommended to conduct a trial recording.
- The digital image stabilizer does not work when recording still images.

## Zooming

The angle of view can be adjusted using zoom.

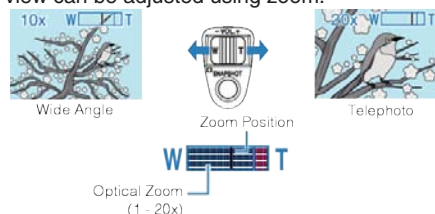

- Use the W end (wide angle end) to shoot a wider field of view.
- Use the T end (telephoto end) to magnify the subject for shooting.

### Memo:

- Digital zoom is not available in the still image recording mode.

## Checking the Captured Image Immediately

You can check the most recently captured images while in the recording mode. (Quick Review)



### Memo:

- You can also delete  the image after checking.
- Quick Review can no longer recall the most recently captured image once the power is turned off. Use the playback mode to check the image in this case.

## Manual Recording

You can adjust settings, such as brightness, by using the manual mode. Manual recording can be set for both video and still image modes.

1 Select video or still image mode.

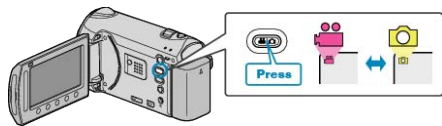

- The video or still image mode icon appears.

2 Select the Manual recording mode.

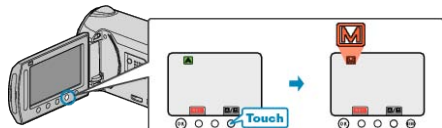

- The mode changes between Auto and Manual with every touch.

3 Start recording.

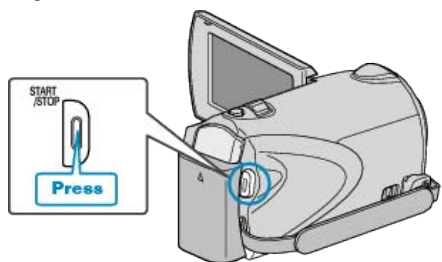

- Press again to stop.

**Memo:**

- The manual settings are displayed only in the manual mode.

## Manual Recording Menu

The following items can be set.

Name	Description
SCENE SELECT	<ul style="list-style-type: none"> <li>• Recordings that suit the shooting conditions can be performed easily.</li> </ul> "Scene Selection" (P.27)
FOCUS	<ul style="list-style-type: none"> <li>• Use manual focus if the subject is not focused automatically.</li> </ul> "Adjusting Focus Manually" (P.28)
FOCUS ASSIST	<ul style="list-style-type: none"> <li>• Use this for adjusting the focus more precisely.</li> </ul> "Using Focus Assist" (P.28)
BRIGHTNESS ADJUST	<ul style="list-style-type: none"> <li>• Overall brightness on the screen can be adjusted.</li> <li>• Use this when recording in a dark or bright location.</li> </ul> "Adjusting Brightness" (P.29)
SHUTTER SPEED (GZ-HM350/GZ-HM330)	<ul style="list-style-type: none"> <li>• Shutter speed can be adjusted.</li> <li>• Use this when shooting a fast-moving subject or to emphasize the subject's movement.</li> </ul> "Setting Shutter Speed (GZ-HM350/GZ-HM330)" (P.29)
WHITE BALANCE	<ul style="list-style-type: none"> <li>• Overall color on the screen can be adjusted.</li> <li>• Use this when the color on the screen appears differently from the actual color.</li> </ul> "Setting White Balance" (P.30)
BACKLIGHT COMP.	<ul style="list-style-type: none"> <li>• Corrects the image when the subject appears dark due to backlight.</li> <li>• Use this when shooting against the light.</li> </ul> "Setting Backlight Compensation" (P.30)
METERING AREA/TYPE	<ul style="list-style-type: none"> <li>• Brightness of a specified area can be set as the standard.</li> </ul> "Setting Metering Area" (P.31)
EFFECT	<ul style="list-style-type: none"> <li>• Images that look like old photographs or black-and-white movies can be taken.</li> </ul> "Recording with Effects" (P.31)
TELE MACRO	<ul style="list-style-type: none"> <li>• Use this to take close-up (macro) shots of the subject.</li> </ul> "Taking Close-up Shots" (P.32)

## Scene Selection

Common scenes that are often encountered can be recorded with the most suitable settings.

1 Touch  to display the menu.

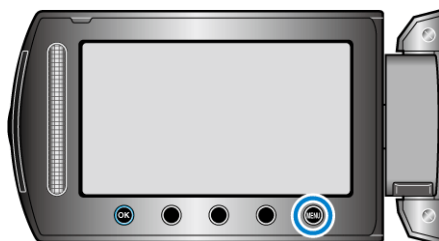

2 Select "MANUAL SETTING" and touch .











































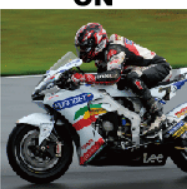

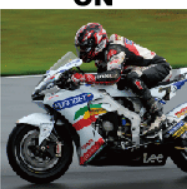

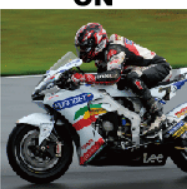











3 Select "SCENE SELECT" and touch .



4 Select the scene and touch .



Setting	Effect					
 NIGHT EYE	Increases gain and brightens the scene automatically when the surrounding is dark. To prevent camera shake, use a tripod. <table style="width: 100%; text-align: center;"> <tr> <td><b>OFF</b></td> <td></td> <td></td> <td><b>ON</b></td> <td></td> </tr> </table>	<b>OFF</b>			<b>ON</b>	
<b>OFF</b>			<b>ON</b>			
 NIGHT (GZ-HM350/GZ-HM330)	Captures night scenes naturally. <table style="width: 100%; text-align: center;"> <tr> <td><b>OFF</b></td> <td></td> <td></td> <td><b>ON</b></td> <td></td> </tr> </table>	<b>OFF</b>			<b>ON</b>	
<b>OFF</b>			<b>ON</b>			
 PORTRAIT (GZ-HM350/GZ-HM330)	Blurs the background to bring out the people in the picture. <table style="width: 100%; text-align: center;"> <tr> <td><b>OFF</b></td> <td></td> <td></td> <td><b>ON</b></td> <td></td> </tr> </table>	<b>OFF</b>			<b>ON</b>	
<b>OFF</b>			<b>ON</b>			
 SPORTS (GZ-HM350/GZ-HM330)	Captures fast-moving subjects clearly in every single frame. <table style="width: 100%; text-align: center;"> <tr> <td><b>OFF</b></td> <td></td> <td></td> <td><b>ON</b></td> <td></td> </tr> </table>	<b>OFF</b>			<b>ON</b>	
<b>OFF</b>			<b>ON</b>			
 SNOW (GZ-HM350/GZ-HM330)	Prevents the subject from appearing too dark when recording snow scenes on a sunny day. <table style="width: 100%; text-align: center;"> <tr> <td><b>OFF</b></td> <td></td> <td></td> <td><b>ON</b></td> <td></td> </tr> </table>	<b>OFF</b>			<b>ON</b>	
<b>OFF</b>			<b>ON</b>			
 SPOT-LIGHT	Prevents the human subject from appearing too bright under light. <table style="width: 100%; text-align: center;"> <tr> <td><b>OFF</b></td> <td></td> <td></td> <td><b>ON</b></td> <td></td> </tr> </table>	<b>OFF</b>			<b>ON</b>	
<b>OFF</b>			<b>ON</b>			

\*The image is only an impression.

### Adjusting Focus Manually

Set this when the focus is not clear in "AUTO" or when manual focusing is desired.

1 Touch **OK** to display the menu.

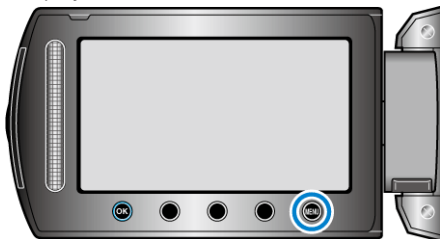

2 Select "MANUAL SETTING" and touch **OK**.



3 Select "FOCUS" and touch **OK**.



4 Select "MANUAL" and touch **OK**.



5 Adjust the focus with the slider.



- Slide upward to focus on a distant subject.
- Slide downward to focus on a near subject.

6 Touch **OK** to confirm.



**Memo:**

- A subject that is focused at the telephoto (T) end remains in focus when it is zoomed out to the wide angle (W) end.

### Using Focus Assist

Focused subject is outlined in color for more precise focus.

1 Touch **OK** to display the menu.

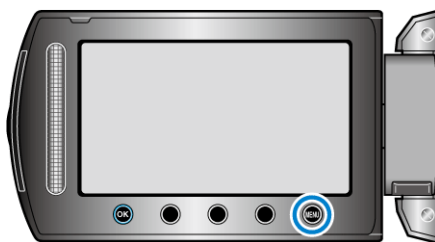

2 Select "MANUAL SETTING" and touch **OK**.



3 Select "FOCUS ASSIST" and touch **OK**.



4 Adjust the focus with the slider.



5 Touch **OK** to confirm.



**Memo:**

- The image becomes black and white while the outline of the focused object is displayed in the selected color. Change outline color if it becomes difficult to see.

"FOCUS ASSIST COLOR" (P.116)



## Adjusting Brightness

You can adjust the brightness to your preferred level.

1 Touch **MENU** to display the menu.

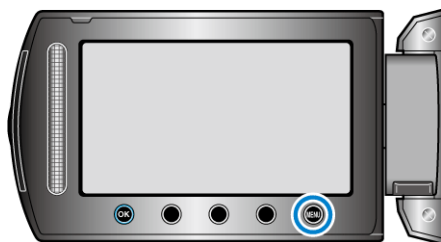

2 Select "MANUAL SETTING" and touch **OK**.



3 Select "BRIGHTNESS ADJUST" and touch **OK**.



4 Select "MANUAL" and touch **OK**.



5 Select the brightness value with the slider.



- Compensation range during video recording: -6 to +6
- Compensation range during still image recording: -2.0 to +2.0
- Slide upward to increase the brightness.
- Slide downward to decrease the brightness.

6 Touch **OK** to confirm.



## Setting Shutter Speed (GZ-HM350/GZ-HM330)

You can set the shutter speed to suit the type of subject.

1 Touch **MENU** to display the menu.

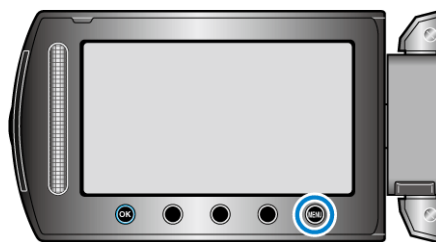

2 Select "MANUAL SETTING" and touch **OK**.



3 Select "SHUTTER SPEED" and touch **OK**.



4 Select "MANUAL" and touch **OK**.



5 Select the shutter speed with the slider.



- Shutter speed can be set from 1/2 to 1/4000.
- Slide upward to increase the shutter speed.
- Slide downward to decrease the shutter speed.

6 Touch **OK** to confirm.



### Memo:

- It is recommended to use a tripod when recording with a slow shutter speed.



### Setting White Balance

You can set the color tone to suit the light source.

1 Touch **MENU** to display the menu.

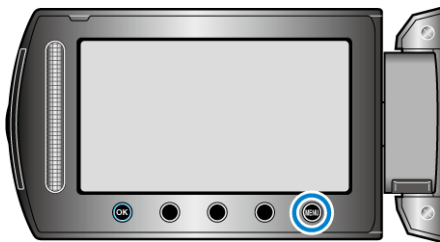

2 Select "MANUAL SETTING" and touch **OK**.



3 Select "WHITE BALANCE" and touch **OK**.



4 Select the desired setting and touch **OK**.



Setting	Details
AUTO	Adjusts automatically to the natural colors.
MWB	Use this when the problem of unnatural colors is not resolved.
FINE	Set this when shooting outdoors on a sunny day.
CLOUD	Set this when shooting on a cloudy day or inside a shade.
HALOGEN	Set this when shooting under illumination such as a video light.

### Using MWB

1 Hold a sheet of plain white paper in front of the lens so that the white paper fills the screen.

2 Select "MWB" and keep touching **OK**.

- The cursor blinks.

3 Release **OK** after the menu disappears.

### Setting Backlight Compensation

You can correct the image when the subject appears too dark due to backlight.

1 Touch **MENU** to display the menu.

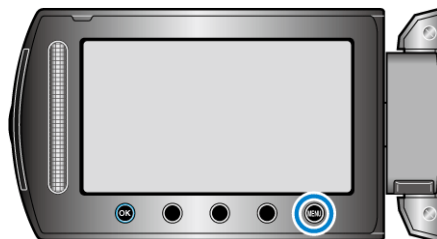

2 Select "MANUAL SETTING" and touch **OK**.



3 Select "BACKLIGHT COMP." and touch **OK**.



4 Select "ON" and touch **OK**.



## Setting Metering Area

You can set the brightness of a specified area as the standard.

1 Touch **OK** to display the menu.



2 Select "MANUAL SETTING" and touch **OK**.



3 Select "METERING AREA/ TYPE" and touch **OK**.



4 Select "SPOT" and touch **OK**.



- When "SPOT" is selected, select the position of the spot frame by touching the operation buttons "←"/"→". After selecting, touch **OK** to confirm.

## Recording with Effects

You can add various effects to videos and still images to create a different atmosphere from the usual recording.



\*The image is only an impression.

1 Touch **OK** to display the menu.



2 Select "MANUAL SETTING" and touch **OK**.



3 Select "EFFECT" and touch **OK**.



4 Select the effect and touch **OK**.



Setting	Details
OFF	No effect.
SEPIA	Gives images a brownish tint like old photographs.
BLACK & WHITE	Records in black and white like old TV images.
CLASSIC FILM	Skips frames to give images of the effect of an old movie. <ul style="list-style-type: none"> <li>This can only be set in the video mode.</li> </ul>
STROBE	Enables the image to look like a series of consecutive snapshots by skipping frames. <ul style="list-style-type: none"> <li>This can only be set in the video mode.</li> </ul>

### Memo:

- Settings can be adjusted separately for videos and still images.

Video	SEPIA / BLACK & WHITE / CLASSIC FILM / STROBE
Still Image	SEPIA / BLACK & WHITE

### Taking Close-up Shots

You can take close-up shots of an object using the tele macro function.



\*The image is only an impression.

1 Touch **MENU** to display the menu.

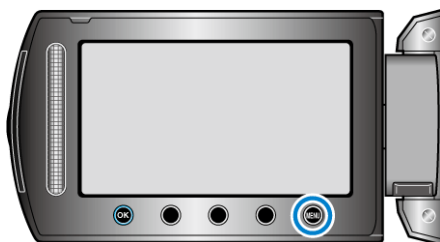

2 Select "MANUAL SETTING" and touch **OK**.



3 Select "TELE MACRO" and touch **OK**.



4 Select "ON" and touch **OK**.



Setting	Details
OFF	Enables close-up shots up to 1 m at the telephoto (T) end. Enables close-up shots up to 5 cm at the wide angle (W) end.
ON	Enables close-up shots up to 60 cm at the telephoto (T) end. (GZ-HM300) Enables close-up shots up to 50 cm at the telephoto (T) end. (GZ-HM350/GZ-HM330) Enables close-up shots up to 5 cm at the wide angle (W) end.

#### Warning

- When you are not taking close-up shots, set "TELE MACRO" to OFF. Otherwise, the image may be blur.

### Registering Files to Events Before Recording

Videos can be found easily during playback by categorizing them when recording.

1 Select video mode.

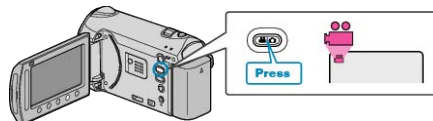

2 Touch **MENU** to display the menu.

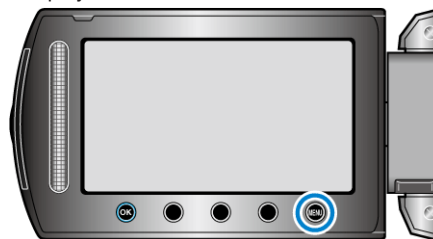

3 Select "REGISTER EVENT" and touch **OK**.



4 Select the event type and touch **OK**.



Event Type
VACATION
HOLIDAY
SPORTS
ANNIVERSARY
CONGRATULATIONS
BABY
SON
DAUGHTER
BIRTHDAY
GRADUATION

- An icon appears on the screen and the video is recorded under the selected event. (Videos will continue to be recorded to the same event until a change is made.)

#### Memo:

- To cancel event registration, touch "CANCEL" in step 4.



- The registered event can be changed again later.  
"Changing the Event of the Currently Displayed File" (P.55)  
"Changing the Event of the Selected Files" (P.56)

## Taking Videos in YouTube™ Format

You can share your enjoyable memories with family and friends easily by posting your videos on the video sharing website YouTube™. Through upload shooting, videos that are suitable for uploading to YouTube™ (within 10 minutes) may be taken directly.

### Memo:

For more information on YouTube™, please visit the following website.  
<http://www.youtube.com/>

#### 1 Select video mode.

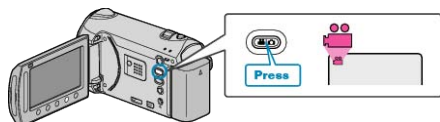

- The video mode icon appears.

#### 2 GZ-HM350/GZ-HM330

Press the UPLOAD/EXPORT button to display the "UPLOAD SETTINGS"/"EXPORT SETTINGS" menu.

GZ-HM300

Press the UPLOAD button. Go to step 4.

- The mode switches between ON and OFF with every press.

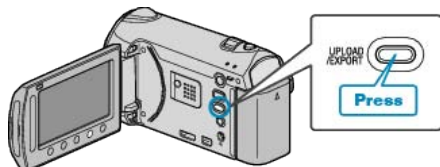

#### 3 Select "UPLOAD SHOOTING" and touch the $\odot$ button.



- The mode switches between ON and OFF with every touch.
- When set to ON, a  $\odot$  mark appears on the screen.
- To cancel this setting, set to "OFF".
- After setting, touch the  $\leftarrow$  button.

#### 4 Start recording.

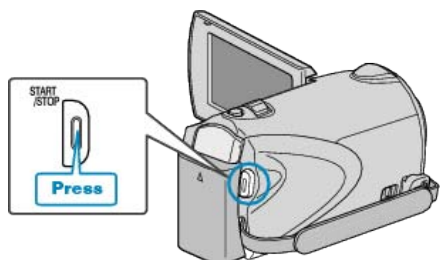

- Press again to stop.
- The maximum recording length of a video in upload mode is 10 minutes.  
Recording stops automatically after 10 minutes.

### Memo:

- Upload recording can only be performed for up to 10 minutes, the time limit of YouTube™.
- Changing videos to the file format for uploading cannot be performed on this unit.  
To upload video files, refer to "Uploading Videos" below.
- The upload recording icon disappears when recording stops.  
To record another video in upload mode, perform the settings again.

## Uploading Videos

You can upload your videos to YouTube™ using the provided software "Everio MediaBrowser".

Install the software on your PC and connect this unit to the PC.

- For details on how to use the software, refer to the help file.

"Installing the Provided Software" (P.88)

"Connecting this Unit to PC" (P.89)

## Trouble with Uploading Videos

- Check if you have created an account with YouTube™.  
(You need a YouTube™ account to upload files to YouTube™.)
- Refer to "Q&A", "Latest Information", "Download Information", etc. in "Click for Latest Product Info" in the help file of the provided software "Everio MediaBrowser".



## Taking Videos in iTunes Format (GZ-HM350/GZ-HM330)

By recording with the EXPORT setting turned on, you can transfer the videos to Apple's software "iTunes" when this unit is connected to a PC. "LIB." is displayed when recording videos in iTunes format. Use the provided software to transfer the videos. "Installing the Provided Software" (P.88)

**Memo:**  
For more information on iTunes and iPod, please visit the following website.  
<http://www.apple.com/itunes/>

1 Select video mode.

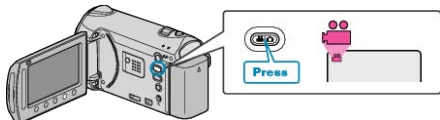

- The video mode icon appears.

2 Press the UPLOAD/EXPORT button to display the "UPLOAD SHOOTING"/"EXPORT SHOOTING" menu.

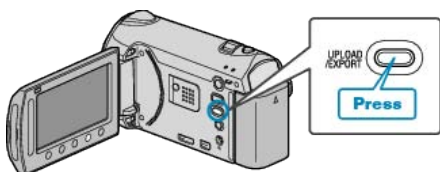

3 Select "EXPORT SHOOTING" and touch the OK button.



- The mode switches between ON and OFF with every touch.
- When set to ON, a "LIB." mark appears on the screen.
- To cancel this setting, set to "OFF".
- After setting, touch the ↶ button.

4 Start recording.

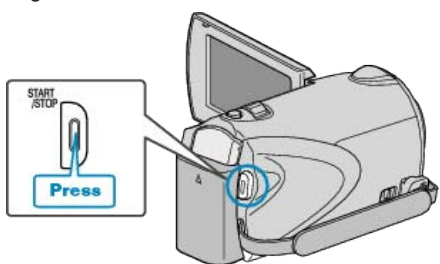

- Press again to stop.

**Memo:**  
The export mode icon disappears when recording stops. To record another video in export mode, perform the settings again.

## Transferring Recorded Videos to iPod

You can export videos to iTunes using the provided software "Everio MediaBrowser".

Install the software on your PC and connect this unit to the PC.

- For details on how to use the software, refer to the help file.
- For details on transferring files to iPod, refer to the help file of iTunes.

"Installing the Provided Software" (P.88)

"Copying All Files" (P.89)

## Trouble with Exporting Files to iTunes

- Refer to "Q&A", "Latest Information", "Download Information", etc. in "Click for Latest Product Info" in the help file of the provided software "Everio MediaBrowser".



## Recording at Intervals (TIME-LAPSE RECORDING)

This function enables the changes of a scene that occur slowly over a long period to be shown within a short time by taking frames of it at a certain interval.

This is useful for making observations such as the opening of a flower bud.

1 Select video mode.

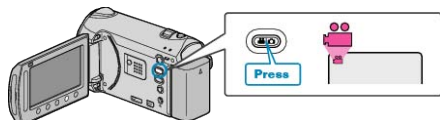

2 Touch **MENU** to display the menu.

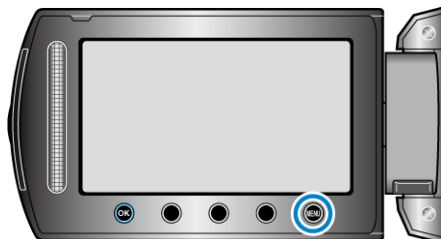

3 Select "TIME-LAPSE RECORDING" and touch **OK**.



4 Select a recording interval (1 to 80 seconds) and touch **OK**.



- The greater the number of seconds, the longer the recording interval.

5 Start recording.

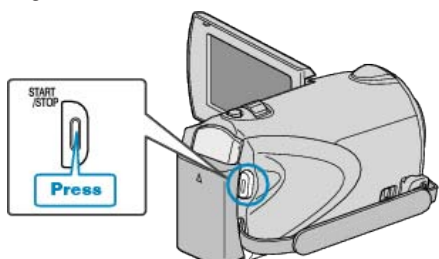

- A frame is taken at intervals of the selected period.
- When the recording interval is set to "20SEC INTERVAL" or higher, this unit switches to the power-saving mode between recordings. At the next point to record, the power-saving mode will be turned off and recording will start automatically.
- Press the START/STOP button again to stop recording.

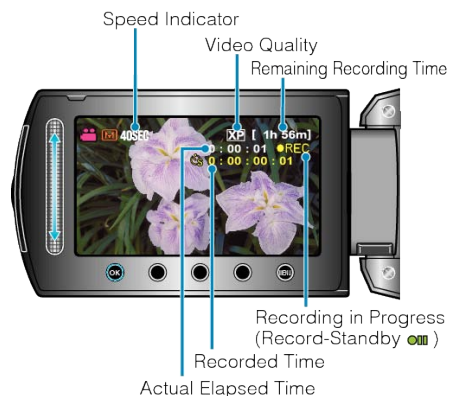

Display	Description
<b>Speed Indicator</b>	Displays the recording interval that is set.
<b>Video Quality</b>	Displays the icon of the video quality that is set.
<b>Remaining Recording Time</b>	Remaining time left to record with the currently selected video quality.
<b>Recording in Progress</b>	Appears when video recording is in progress. When in the power-saving mode, it blinks.
<b>Record-Standby</b>	Appears when video recording is paused.
<b>Actual Elapsed Time</b>	Displays the actual elapsed time after recording starts.
<b>Recorded Time</b>	Displays the actual recorded time of the video. Recorded time increases in units of frames.

### Indications During Time-Lapse Recording

**Time-Lapse Setting**

The greater the number of seconds, the longer the recording interval.

Setting	Details
<b>OFF</b>	Deactivates the function.
<b>1SEC INTER-VAL</b>	Takes a frame at 1-second intervals. Recorded videos will be played back at 30 times speed.
<b>2SEC INTER-VAL</b>	Takes a frame at 2-second intervals. Recorded videos will be played back at 60 times speed.
<b>5SEC INTER-VAL</b>	Takes a frame at 5-second intervals. Recorded videos will be played back at 150 times speed.
<b>10SEC INTER-VAL</b>	Takes a frame at 10-second intervals. Recorded videos will be played back at 300 times speed.
<b>20SEC INTER-VAL</b>	Takes a frame at 20-second intervals. Recorded videos will be played back at 600 times speed.
<b>40SEC INTER-VAL</b>	Takes a frame at 40-second intervals. Recorded videos will be played back at 1 200 times speed.
<b>80SEC INTER-VAL</b>	Takes a frame at 80-second intervals. Recorded videos will be played back at 2 400 times speed.

**CAUTION:**

- Audio cannot be recorded during time-lapse recording.
- Zooming, simultaneous still image recording, and image stabilizer are not available in time-lapse recording.
- When recording is stopped with the recorded time less than "0:00:00:14", the video will not be saved.

**Memo:**

- Settings of time-lapse recording are saved even when the power is turned off. When the power is turned on, "TIME LAPSE" appears on the screen.
- Recording stops automatically 99 hours after it is started.
- Make use of a tripod and AC adapter for time-lapse recordings with long intervals. It is also recommended to fix the focus and white balance manually.

"Tripod Mounting" (P.18)  
 "Adjusting Focus Manually" (P.28)  
 "Setting White Balance" (P.30)

**Recording Automatically by Sensing Movements (AUTO REC)**

This function enables the unit to record automatically by sensing the changes in subject's movement (brightness) within the red frame displayed on the LCD monitor. (AUTO REC) It can be set for both video and still image modes.

1 Select video or still image mode.

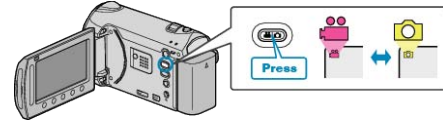

2 Compose the picture according to the subject.

- Adjust the angle of view with the zoom, etc.

3 Touch **MEMU** to display the menu.

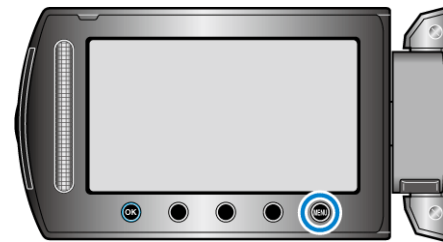

4 Select "AUTO REC" and touch **OK**.



5 Select "ON" and touch **OK**.



6 Recording starts automatically when the subject within the red frame moves.



- A red frame appears 2 seconds after the menu display disappears.
- For video recording, recording continues while there are still movements of the subject (changes in brightness) within the red frame. When there are no more movements of the subject (changes in brightness) within the red frame, recording will stop in 5 seconds.
- To stop video recording manually, press the START/STOP button. However, as the AUTO REC setting remains at ON even after the video recording is stopped, recording starts again when movements of the subject (changes in brightness) are detected within the red frame. To cancel AUTO REC, set it to "OFF".

**CAUTION:**

- The only manual recording setting available is "TELE MACRO".

The rest are all set to "AUTO".

- Digital zoom, image stabilizer, self-timer, and continuous shooting are not available after AUTO REC is set.
- AUTO REC cannot be used together with TIME-LAPSE RECORDING. When both are set, priority is given to TIME-LAPSE RECORDING.
- IMAGE SIZE cannot be changed after AUTO REC is selected. Set it before selecting AUTO REC.
- The auto power off and power-saving modes are not available after AUTO REC is set.

#### Memo:

- Recording stops when there are no changes for 5 seconds during video recording.
- Recording may not start when the movements of the subject within the red frame are too fast or the changes in brightness are too small.
- Recording may not start when the change in brightness is too small.
- Recording may start due to changes in brightness even if there is no movement of the subject within the red frame.
- The performance of AUTO REC is affected by its sensitivity to the surrounding brightness. The function may not work with certain environments.
- While zooming, recording cannot be started.

## Remaining Recording Time/Battery Power

You can check the remaining video recording time on the internal memory and SD card as well as the remaining battery power.

- 1 Select video mode.

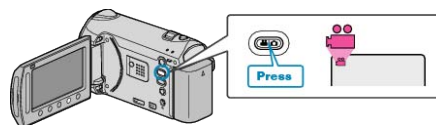

- The video mode icon appears.



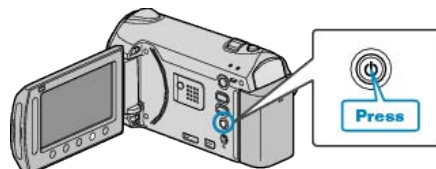

- 2 Press .



- Press once to display the remaining recording time of the selected media for video recording. Go to step 3.
- Press twice to display the remaining recording time of the other media. Go to step 4.
- Press thrice to display the remaining battery power. Go to step 5.



- 3 Display the remaining recording time of the selected media for video recording.



- To set this media as the recording media, touch .
- To change the video quality, select video quality with the slider and touch .
- To display the remaining battery power, touch the ";" button.
- To display the remaining recording time of the other media, press the INFO button  once.
- To exit the display, touch the .

- 4 Display the remaining recording time of the other media.



- To set/change this media as the recording media, touch .
- To change the video quality, select video quality with the slider and touch .
- To display the remaining battery power, touch the ";" button.
- To exit the display, touch the .

- 5 Display the remaining battery power.



- To exit the display, press the INFO button  or touch the .

## Recording

---

**Memo:** \_\_\_\_\_

- The remaining battery power will not be displayed when the AC adapter is connected.
-

## Approximate Video Recording Time

Quality	Built-in Memory 8 GB	Built-in Memory 32 GB	SD Card/ SDHC Card 4 GB	SD Card/ SDHC Card 8 GB	SD Card/ SDHC Card 16 GB	SD Card/ SDHC Card 32 GB
UXP	40 m	2 h 55 m	20 m	40 m	1 h 20 m	2 h 40 m
XP	1 h	4 h 5 m	30 m	1 h	2 h	4 h
SP	1 h 25 m	5 h 50 m	44 m	1 h 28 m	2 h 56 m	5 h 52 m
EP	3 h 35 m	14 h 40 m	1 h 50 m	3 h 40 m	7 h 20 m	14 h 40 m

- Built-in memory applies to GZ-HM350/GZ-HM330 only.
- The actual recording time may shorten depending on the shooting environment.

## Approximate Number of Still Images (Unit: Number of Shots)

Image Size	Quality	Built-in Memory 8 GB	SD Card 256 MB	SD Card 512 MB	SD Card 1 GB	SD Card 2 GB	SD/SDHC Card 4 GB	SD/SDHC Card 8 GB
1920x1080 (16:9)	FINE	8260	260	510	1030	2100	4140	8330
1920x1080 (16:9)	STANDARD	9999	410	810	1620	3210	6310	9999
1440x1080 (4:3)	FINE	9999	340	680	1360	2770	5450	9999
1440x1080 (4:3)	STANDARD	9999	540	1070	2140	4360	8570	9999
640x480 (4:3)	FINE	9999	1690	3330	6670	9999	9999	9999
640x480 (4:3)	STANDARD	9999	3050	5990	9999	9999	9999	9999

- Up to 9999 still images may be recorded on the built-in memory or SD cards with at least 16 GB capacity (regardless of image size and quality).

## Approximate Recording Time (Using Battery)

Battery Pack	Charging Time	Actual Recording Time (GZ-HM350/GZ-HM330)	Actual Recording Time (GZ-HM300)	Continuous Recording Time (GZ-HM350/GZ-HM330)	Continuous Recording Time (GZ-HM300)
BN-VG114E (Supplied)	2 h 30 m	55 m	1 h	1 h 40 m	1 h 45 m
BN-VG121E	3 h 30 m	1 h 25 m	1 h 30 m	2 h 30 m	2 h 40 m

\*The above are values when "LIGHT" is set to "OFF" and "LCD BACKLIGHT" is set to "STANDARD".

Battery Pack	Charging Time	Actual Recording Time (GZ-HM350/GZ-HM330)	Actual Recording Time (GZ-HM300)	Continuous Recording Time (GZ-HM350/GZ-HM330)	Continuous Recording Time (GZ-HM300)
BN-VG114E (Supplied)	2 h 30 m	50 m	50 m	1 h 30 m	1 h 35 m
BN-VG121E	3 h 30 m	1 h 15 m	1 h 20 m	2 h 20 m	2 h 25 m

\*The above are values when "LIGHT" is set to "OFF" and "LCD BACKLIGHT" is set to "BRIGHTER".

- The actual recording time may be shorter if zooming is used or if recording is stopped repeatedly.  
(It is recommended to prepare battery packs ready for three times the expected recording time.)
- When the battery life is reached, the recording time becomes shorter even if the battery pack is fully charged.  
(Replace the battery pack with a new one.)

## Playing Back Videos

You can select and play back the recorded videos from an index screen (thumbnail display).

The contents of the saving destination selected in "REC MEDIA FOR VIDEO" or "VIDEO SLOT SELECTION" are displayed on the index screen.

"REC MEDIA FOR VIDEO (GZ-HM350/GZ-HM330)" (P.127)

"VIDEO SLOT SELECTION (GZ-HM300)" (P.127)

1 Select the playback mode.

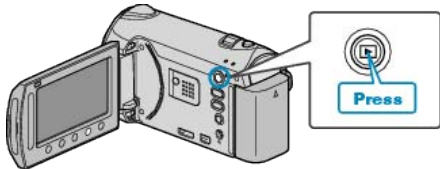

2 Select video mode.

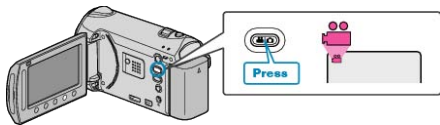

3 Select the desired video and touch OK.



- If the cursor stops at a thumbnail display of a video in which faces are detected, the faces are panned in and played back for a while.
- Touch ■ to stop playback.

### Operation Buttons for Video Playback

<During Index Screen Display>

Select video (Press and hold to move pages)



<During Playback>

Returns to Beginning of Video



Playback/Pause Stop Forward Search Reverse Search

### During Index Screen Display

Display	Description
▶	Starts playback of the selected file.
DIGEST	You can play back a digest of the recorded videos.
Q	You can search for a specific file by the recording date or registered category (event).
🗑️	Deletes the selected file.
▲/▼	Press and hold to move the pages of the index screen.

### During Video Playback

Display	Description
▶ /	Playback/pause
■	Stop (returns to thumbnail display)
▶▶	Advances to the next video
◀◀	Returns to the beginning of the scene
▶▶▶	Forward search
◀◀◀	Reverse search
▶	Forward slow-motion
◀	Reverse slow-motion

#### Memo:

- Touch the slider and buttons around the screen with your fingers.
- The slider and buttons do not function if you touch them with your fingernails or with gloves on.
- The displays on the screen do not work even if you touch them.
- You can search for a specific file by the recording date or registered category (event).  
This is useful when searching from a large number of files.

"Group Search" (P.44)

"Search Date" (P.44)

"Search Event" (P.45)

#### CAUTION:

- Make a backup of important recorded data.  
It is recommended to copy your important recorded data to a DVD or other recording media for storage. JVC will not be responsible for any lost data.

### Adjusting the Volume of Videos

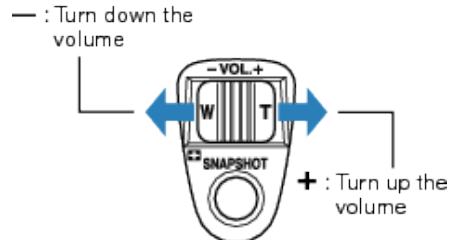

### Checking the Recording Date and Other Information

You can display the recording date and duration of the selected file.

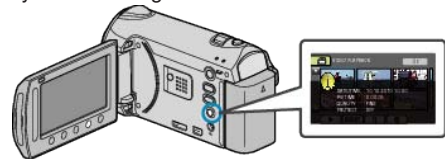

### Increasing/Decreasing the Number to Display on the Index Screen.

Operate the zoom lever when the index screen is displayed (thumbnail display) to change the number of files on the screen in the following order: 6 files → 12 files → 3 files.

- Information of the files also appear when 3 files are displayed.



### Checking the Content of Videos Quickly

You can play back a digest of the recorded videos (Digest Playback). This is useful for checking the content of the videos quickly.



### Operation Buttons for Digest Playback



Display	Description
▶ /	Playback/pause
■	Stop (returns to thumbnail display)
▶ NORM	Returns to normal playback.
▶▶	Advances to the next video
◀◀	Returns to the beginning of the scene
▶▶	Forward search
◀◀	Reverse search
▶▶	Forward slow-motion
◀◀	Reverse slow-motion

### Playing a Video with Defective Management Information

Plays videos with defective management information.

1 Select the playback mode.

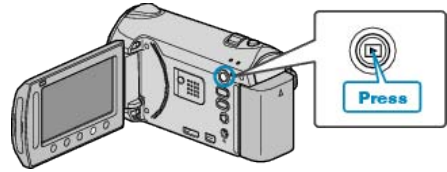

2 Select video mode.

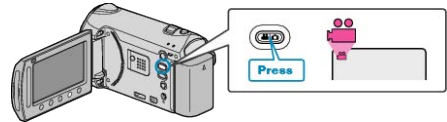

3 Touch to display the menu.

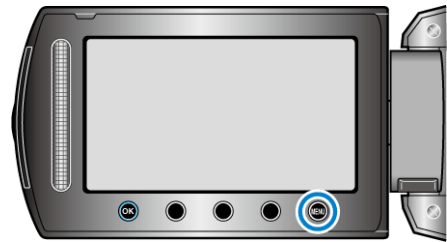

4 Select "PLAYBACK OTHER FILE" and touch .



5 Select the desired video and touch .



"Operation Buttons for Video Playback" (P.40)

#### Memo:

- An MTS file is created in the EXTMOV folder when management information is corrupted.
- Depending on the condition of the damaged file, playback might fail or may not run smoothly.

## Playback with Special Effects

You can add effects to the beginning and end of recorded videos.

1 Select the playback mode.

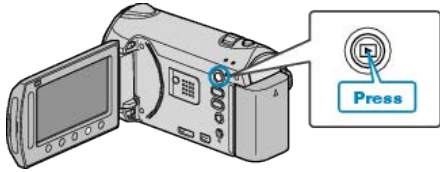

2 Select video mode.

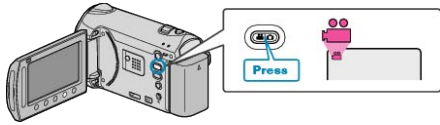

3 Touch **Ⓜ** to display the menu.

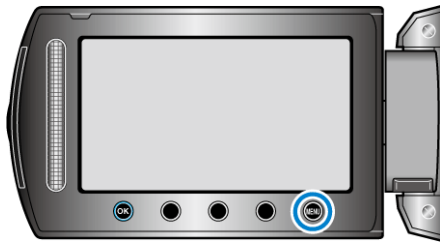

4 Select "WIPE/FADER" and touch **Ⓚ**.



5 Select a desired effect and touch **Ⓚ**.



6 Select the desired video and touch **Ⓚ**.



Setting	Details
OFF	Turns off the effect.
FADER-WHITE	Fades in or out with a white screen.
FADER-BLACK	Fades in or out with a black screen.
WIPE-SLIDE	Wipes in from right to left, or wipes out in the opposite way.
WIPE-DOOR	Wipes in as the two halves of a black screen which open to the left and right revealing the scene, or wipes out in the opposite way.
WIPE-SCROLL	Wipes in from the bottom to the top of a black screen, or wipes out in the opposite way.
WIPE-SHUTTER	Wipes in from the center of a black screen toward the top and bottom, or wipes out in the opposite way.

### Memo:

- The effect will not be applied to a recorded video less than 7 seconds.
- The wipe/fader effects are temporary. They do not affect the files directly, and can be disabled when the function is set to "OFF".

## Playing Back Still Images

You can select and play back the recorded still images from an index screen (thumbnail display). The contents of the saving destination selected in "REC MEDIA FOR IMAGE" or "IMAGE SLOT SELECTION" are displayed on the index screen. "REC MEDIA FOR IMAGE (GZ-HM350/GZ-HM330)" (P.128) "IMAGE SLOT SELECTION (GZ-HM300)" (P.128)

1 Select the playback mode.

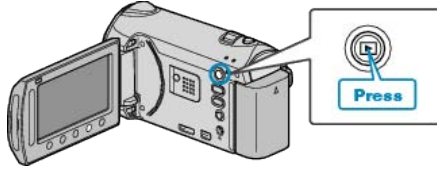

2 Select still image mode.

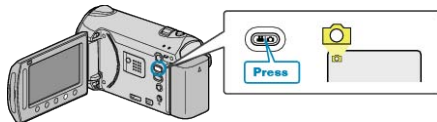

3 Select a still image and touch  $\odot$  to start playback.



• Touch  $\blacksquare$  to stop playback.

### Operation Buttons for Still Image Playback

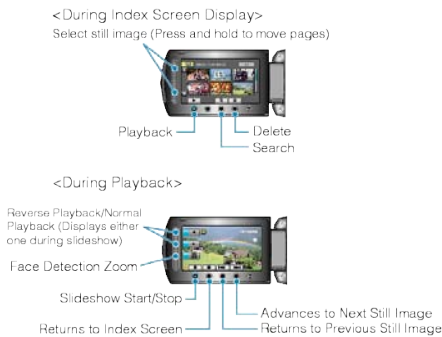

### During Index Screen Display

Display	Description
$\blacktriangleright$	Starts playback of the selected file.
$\text{Q}$	You can search for a specific file by the recording date.
$\text{W}$	Deletes the selected file.
$\blacktriangle / \blacktriangledown$	Press and hold to move the pages of the index screen.

### During Still Image Playback

Display	Description
$\blacktriangleright / \text{II}$	Start/pause slideshow
$\blacksquare$	Stop (returns to thumbnail display)
$\blacktriangleright \blacktriangleright$	Advances to the next still image
$\blacktriangleleft \blacktriangleleft$	Returns to the previous still image
$\blacktriangleleft$	Plays back in reverse order during a slideshow.
$\blacktriangleright$	Plays back in normal ascending order during a slideshow.
$\text{Q}$	Face Detection Zoom "Face Detection Zoom" (P.58)

### Memo:

- Touch the slider and buttons around the screen with your fingers.
- The slider and buttons do not function if you touch them with your fingernails or with gloves on.
- The displays on the screen do not work even if you touch them.
- You can search for a specific file by the recording date. This is useful when searching from a large number of files. "Search Date" (P.44)

### Checking the Recording Date and Other Information

You can display the recording date and duration of the selected file.

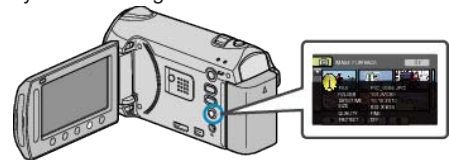

### Increasing/Decreasing the Number to Display on the Index Screen.

Operate the zoom lever when the index screen is displayed (thumbnail display) to change the number of files on the screen in the following order: 6 files  $\rightarrow$  12 files  $\rightarrow$  3 files.

- Information of the files also appear when 3 files are displayed.

### Slideshow Playback

Still images can be played back in a slideshow. Start the slideshow by pressing the play button during still image playback.



"Operation Buttons for Still Image Playback" (P.43)

### Memo:

- Effects can be added to the transitions in slideshow playback. "SLIDE SHOW EFFECTS" (P.113)

## Searching for a Specific Video/Still Image

When there is a large number of recorded videos and still images, it is difficult to look for the desired file from the index screen.

Use the search function to find the file you want.

- For videos, you can search by "GROUP", "SEARCH DATE", or "SEARCH EVENT".
- For still images, you can search by "SEARCH DATE".

"To search by groups with similar recording dates" (P.44)

"To search by recording dates" (P.44)

"To search by events and recording dates" (P.45)

### Group Search

You can search and play videos which are automatically grouped according to similar recording dates.

- The contents of the saving destination selected in "REC MEDIA FOR VIDEO" or "VIDEO SLOT SELECTION" are searched.

1 Display the search function.



- You can also display the search menu by selecting "SEARCH" on the playback menu.

2 Select "GROUP" and touch **OK**.



3 Select from the index screen (thumbnails) and touch **OK** to start playback.



- The video starts playing.
- Touch **STOP** to stop playback.

#### Memo:

- Touch "DIGEST" to play back a few seconds from each video, allowing you to check the contents of many videos in a short time.
- Groups are created automatically according to recording dates.
- The group may change when the recording is continued.
- Select "DELETE" from the playback menu to delete unwanted files.

"Deleting Unwanted Files" (P.49)

### Search Date

You can search and play videos or still images according to recording dates.

- The contents of the saving destination selected in "REC MEDIA FOR VIDEO", "REC MEDIA FOR IMAGE", "VIDEO SLOT SELECTION", or "IMAGE SLOT SELECTION" are searched.
- Still images can only be searched by "SEARCH DATE".

1 Display the search function.



- You can also display the search menu by selecting "SEARCH" on the playback menu. For still images, select "SEARCH DATE" on the menu.
- Searching can be performed in both the video and still image modes.  
\*The image shows the video mode.

2 Select "SEARCH DATE" and touch **OK**.



3 Select a recording date and touch **OK**.



- The starting day of the week on the calendar switches between Sunday and Monday with every touch of the **MON** button.

4 Select the desired video or still image and touch **OK** to start playback.



- You can select videos in the video mode and still images in the still image mode.
- Only the videos recorded on the selected date are displayed.

#### Deleting Files of a Selected Date :

Select "DELETE" from the playback menu to delete unwanted files.

"Deleting Unwanted Files" (P.49)



### Search Event

You can search and play videos according to events and recording dates.

- The contents of the saving destination selected in "REC MEDIA FOR VIDEO" or "VIDEO SLOT SELECTION" are searched.
  - Events that are not registered will not appear.
- "Registering Files to Events" (P.99)

1 Display the search function.



- You can also display the search menu by selecting "SEARCH" on the playback menu.

2 Select "SEARCH EVENT" and touch **OK**.



3 Select the event type and touch **OK**.



4 Select a recording date and touch **OK**.



- The starting day of the week on the calendar switches between Sunday and Monday with every touch of the **☰** button.
- Only the videos recorded on the selected date are displayed.

5 Select the desired file and touch **OK** to start playback.



Deleting Files of a Selected Date : \_\_\_\_\_  
 Select "DELETE" from the playback menu to delete unwanted files.  
 "Deleting Unwanted Files" (P.49)

### Connecting to and Viewing on TV

You can output images from the HDMI connector, COMPONENT connector, or AV connector. Select the connector that best suits your TV.

- Refer also to the instruction manual of the TV in use.
- "Connecting via the HDMI Mini Connector" (P.46)  
 "Connecting via the Component Connector" (P.47)  
 "Connecting via the AV Connector" (P.47)

**Memo:**

- To play back with date/time display, set "DISPLAY ON TV" in the connection settings menu to "ON". Set "ON-SCREEN DISPLAY" in the playback menu to "DISPLAY ALL" or "DISPLAY DATE ONLY".
- "DISPLAY ON TV" (P.124)  
 "ON-SCREEN DISPLAY" (P.111)
- For questions about the TV or method of connection, contact your TV's manufacturer.

### Unnatural Displays on TV

Trouble	Action
Images do not appear on the TV properly.	<ul style="list-style-type: none"> <li>• Disconnect the cable and connect again.</li> <li>• Turn off and on this unit again.</li> <li>• When connected via the component connector, check if the setting of "COMPONENT OUTPUT" in the connection settings menu suits the connected TV. (Set to "1080i" by default)</li> </ul>
Images are projected vertically on the TV.	<ul style="list-style-type: none"> <li>• Set "VIDEO OUTPUT" in the connection settings menu to "4:3".</li> </ul> <p>"VIDEO OUTPUT" (P.124)</p>
Images are projected horizontally on the TV.	<ul style="list-style-type: none"> <li>• Adjust the TV's screen accordingly.</li> </ul>
The color of images looks strange.	<ul style="list-style-type: none"> <li>• If the video was recorded with "x.v.Color" set to "ON", set the x.v.Color setting of the TV to on.</li> <li>• Adjust the TV's screen accordingly.</li> </ul>
HDMI-CEC functions do not work properly, and the TV does not work in conjunction with this unit.	<ul style="list-style-type: none"> <li>• TVs may operate differently depending on the specifications, even if they are HDMI-CEC compliant. Therefore, the HDMI-CEC functions of this unit cannot be guaranteed to operate in combination with all the TVs. In such cases, set "HDMI CONTROL" to "OFF".</li> </ul> <p>"HDMI CONTROL" (P.126)</p>
The language on the display changed.	<ul style="list-style-type: none"> <li>• It may occur when you connect this unit to a TV with different language setting using an HDMI mini cable.</li> </ul>



## Connecting via the HDMI Mini Connector

We recommend using the Category 2 HDMI cable (High Speed cable).

### 1 Connect to the TV.

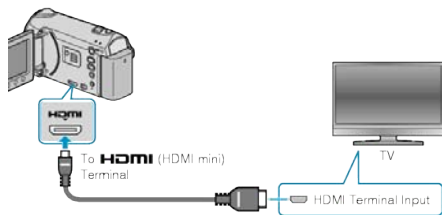

- Press and hold the power button  for 2 seconds or more to turn off the power.

### 2 Connect the AC adapter to this unit.

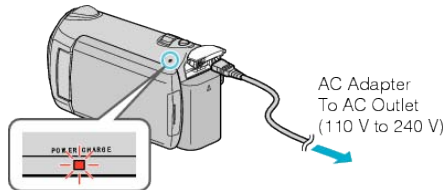

- ### 3 Press the external input button on the TV to switch to the input from this unit via the connected terminal.



### 4 Play back a file.



"Playing Back Videos" (P.40)

"Playing Back Still Images" (P.43)

#### Memo:

- Change the settings in "HDMI OUTPUT" according to the connection. "HDMI OUTPUT" (P.125)
- When connecting to the HDMI mini cable, the image or sound may not appear on the TV properly depending on the TV connected. In such cases, perform the following operations.
  - 1) Disconnect the HDMI mini cable and connect it again.
  - 2) Turn off and on this unit again.
- Connecting this unit to an HDMI-CEC-enabled TV using the HDMI cable allows you to utilize the following convenient functions.

"Operating in Conjunction with TV via HDMI" (P.46)

## Operating in Conjunction with TV via HDMI

Connecting this unit to an HDMI-CEC-enabled TV using the HDMI cable allows you to utilize the following convenient functions.

- HDMI-CEC (Consumer Electronics Control) is an industry standard that enables interoperability between HDMI-CEC compliant devices that are connected via HDMI cables.

#### Memo:

- Not all HDMI-control devices comply with the HDMI-CEC standard. The HDMI control function of this unit will not work when connected to these devices.
- This unit is not guaranteed to operate with all HDMI-CEC-enabled devices.
- Depending on the specifications of each HDMI-CEC-enabled device, some functions may not work with this unit. (For details, refer to the instruction manual of your TV.)
- Unintended operations may occur with some connected devices. In these cases, set "HDMI CONTROL" to "OFF".

"HDMI CONTROL" (P.126)

## Preparations

- Connect an HDMI cable between this unit and the TV.
- Turn on the TV and set the HDMI-CEC related setting to "ON". (For details, refer to the instruction manual of the TV.)
- Turn on this unit and set "HDMI CONTROL" to "ON".

"HDMI CONTROL" (P.126)

## Operation Method 1

### 1 Turn on this unit.

### 2 Select the playback mode.

### 3 Connect the HDMI cable.

- TV turns on automatically and switches to HDMI input mode when this unit is turned on.

## Operation Method 2

### 1 Turn off the TV.

- This unit turns off automatically.

#### Memo:

- Depending on the TV connected, the display language of this unit will automatically switch to the language that is selected for the TV when this unit is turned on.

(This is applicable only if this unit supports the language selected for the TV.) To use this unit with a language that differs from the display language of the TV, set "HDMI CONTROL" to "OFF".

"HDMI CONTROL" (P.126)

- The display language of the TV will not switch automatically, even if the display language of this unit is changed.
- These functions may not work correctly when devices such as amplifier and selector are connected. Set "HDMI CONTROL" to "OFF".

"HDMI CONTROL" (P.126)

- If HDMI-CEC does not work properly, turn off and on this unit again.

#### CAUTION:

- Do not remove the recording medium or perform any other operation (such as turning off the power) while accessing files. Also, be sure to use the provided AC adapter, as the data on the recording medium may be corrupted if the battery becomes exhausted during operation. If the data on the recording medium becomes corrupted, format the recording medium to use the medium again.

### Connecting via the Component Connector

1 Connect to the TV.

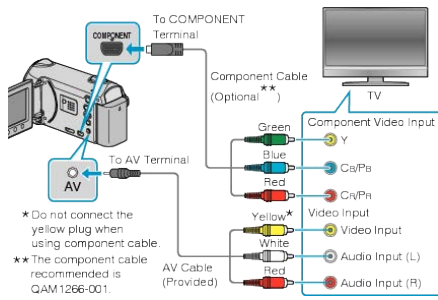

- Press and hold the power button for 2 seconds or more to turn off the power.

2 Connect the AC adapter to this unit.

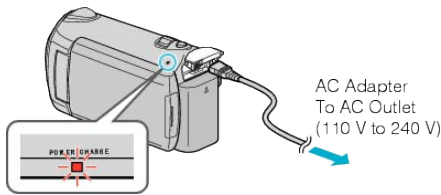

3 Press the external input button on the TV to switch to the input from this unit via the connected terminal.

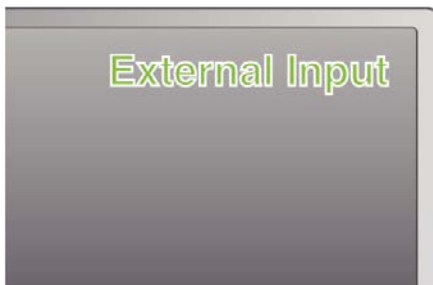

4 Play back a file.



"Playing Back Videos" (P.40)  
 "Playing Back Still Images" (P.43)

**Memo:**

- Change the settings in "COMPONENT OUTPUT" according to the connection.

"COMPONENT OUTPUT" (P.125)

### Connecting via the AV Connector

1 Connect to the TV.

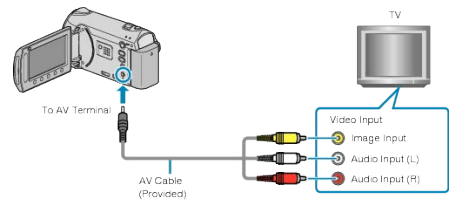

- Press and hold the power button for 2 seconds or more to turn off the power.

2 Connect the AC adapter to this unit.

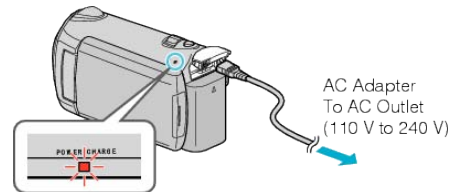

3 Press the external input button on the TV to switch to the input from this unit via the connected terminal.



4 Play back a file.



"Playing Back Videos" (P.40)  
 "Playing Back Still Images" (P.43)

**Memo:**

- Change the settings in "VIDEO OUTPUT" to suit the screen size of your TV.

"VIDEO OUTPUT" (P.124)

## Playing Back Playlists

Play back the playlists that you have created.

1 Select the playback mode.

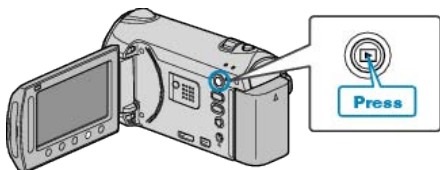

2 Select video mode.

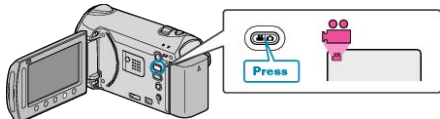

3 Touch  $\text{MENU}$  to display the menu.

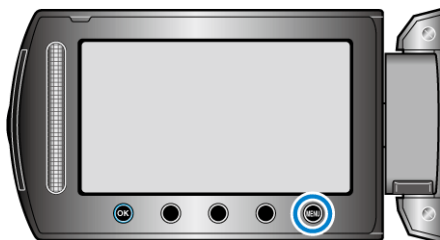

4 Select "PLAYBACK PLAYLIST" and touch  $\text{OK}$ .



5 Select the desired playlist and touch  $\text{OK}$  to start playback.



"Operation Buttons for Playback" (P.40)

- Touch "CHECK" to check the content of the selected playlist.
- To exit the playback, touch  $\text{MENU}$ .

Creating Playlists :

"Creating Playlists from the Recorded Videos" (P.63)

"Adding Title Screens to Playlists (GZ-HM350/GZ-HM330)" (P.69)

## Playing Back a BD/DVD Created on this Unit (GZ-HM350/GZ-HM330)

BD/DVDs created using the backup function on this unit can be played back on TV using an optional DVD writer (DVDs only) with playback function (CU-VD50) or a normal BD/DVD player. DVDs can also be played back on this unit by connecting the optional DVD writer with playback function.

Playback Device	Illustration
DVD writer with playback function (CU-VD50)	
BD/DVD player or BD/DVD recorder that supports the BD/DVD-Video standard	

### Playing Back with a BD/DVD Writer

1 Connect the USB cable and AC adapter.

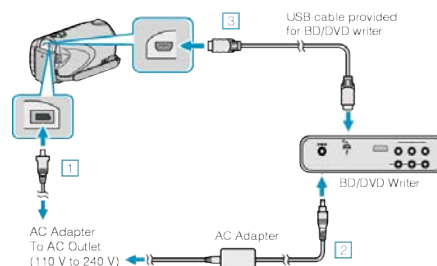

- 1 Connect the AC adapter to this unit.
- 2 Connect the AC adapter of the BD/DVD writer.
- 3 Connect the USB cable provided with the BD/DVD writer.

- To view on a TV, connect this unit to the TV. "Connecting to and Viewing on TV" (P.45)

2 Open the LCD monitor.

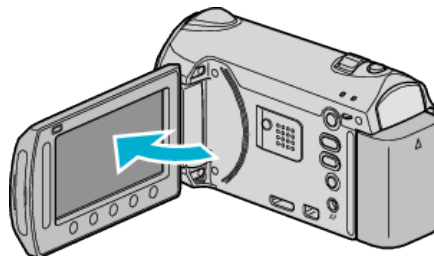

- The CREATE DVD menu appears.

3 Load a BD/DVD created on this unit.



- 1 Press the power button to turn on the power.
- 2 Press the eject button to open the disc tray.
- 3 Pull out the tray completely and load a new disc properly.
- 4 Push the disc tray in until it clicks into place.

4 Select "PLAYBACK" and touch  $\text{OK}$ .



5 Select the desired file and touch **OK**.



- Touch **■** to stop playback.

**CAUTION:**

- Be sure to turn off the power when connecting the devices. Otherwise, electric shocks or malfunctions may occur.

**Memo:**

- Only BD/DVDs created on this unit can be played back.
- Chapters are not displayed on the menu.

**Digest Playback**

You can view a few seconds of each video in the disc continuously by playing back the created disc in a player and selecting "DIGEST PLAYBACK" from the top menu. Use this to check the content of videos or to look for the desired scene.

- To return to normal playback, press the top menu button on the remote control of the player and select "TO NORMAL PLAYBACK".

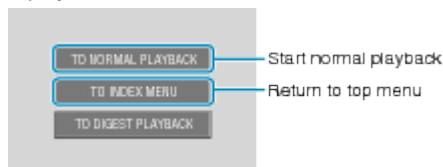

**Deleting Unwanted Files**

Delete unwanted videos and still images when the space in the recording media is running out.

The capacity of the recording media can be restored after deleting the files.

"Deleting the Currently Displayed File" (P.49)

"Deleting Selected Files" (P.50)

"Deleting All Files" (P.51)

**Memo:**

- Deleted files cannot be restored.
- When files in a playlist are deleted, the playlist changes.
- Files that are protected cannot be deleted. Release protection before deleting the file.

"Protecting Files" (P.52)

- Back up all wanted files to your PC.

"Backing Up All Files" (P.89)

**CAUTION:**

- Do not remove the recording medium or turn off the power while accessing files.
- Use the provided AC adapter.
- If the data on the recording medium becomes corrupted, reformat the medium again.

"FORMAT BUILT-IN MEM. (GZ-HM350/GZ-HM330)" (P.129)

"FORMAT SD CARD" (P.129)

**Deleting the Currently Displayed File**

Deletes the currently displayed file.

**CAUTION:**

- Deleted files cannot be restored.

1 Select the playback mode.

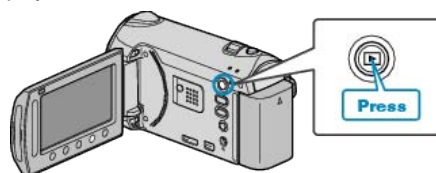

2 Select video or still image mode.

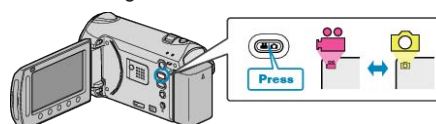

3 Touch **Ⓜ** to display the menu.

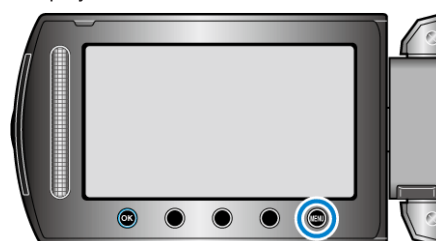

4 Select "DELETE" and touch **OK**.



5 Select "CURRENT" and touch **OK**.



6 Check that it is the file to delete, select "YES" and touch **OK**.



- The file to delete appears on this screen.
- Touch the operation buttons "←" / "→" to select the previous or next file.
- After deleting, touch **MEMO**.

**Memo:**

- When files in a playlist are deleted, the playlist changes.
- Files that are protected cannot be deleted. Release protection before deleting the file.

"Protecting Files" (P.52)

**Deleting Selected Files**

Deletes the selected files.

**CAUTION:**

- Deleted files cannot be restored.

1 Select the playback mode.

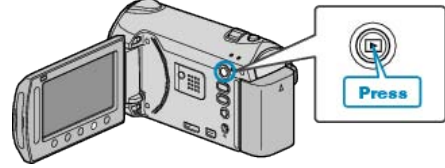

2 Select video or still image mode.

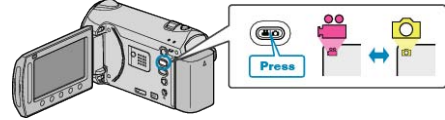

3 Touch **MEMO** to display the menu.

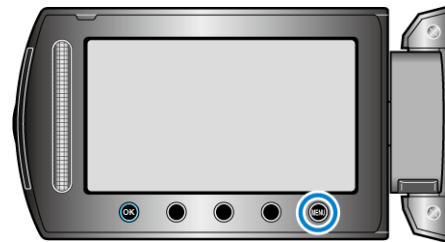

4 Select "DELETE" and touch **OK**.



5 Select "FILE SELECT" and touch **OK**.



6 Select the desired file and touch **OK**.



7 After selecting all the files to delete, touch "EXEC".





- A delete mark appears on the selected file. To remove the delete mark, touch **OK** again.
- Touch "CHECK" to check the selected file.

8 Select "YES" and touch **OK**.



- After deleting, touch **OK**.

**Memo:**

- When files in a playlist are deleted, the playlist changes.
- Files that are protected cannot be deleted. Release protection before deleting the file.

"Protecting Files" (P.52)

**Deleting All Files**

Deletes all files.

**CAUTION:**

- Deleted files cannot be restored.

1 Select the playback mode.

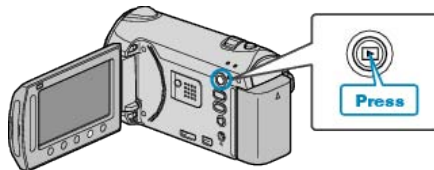

2 Select video or still image mode.

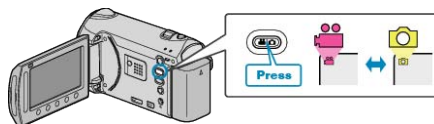

3 Touch **MENU** to display the menu.

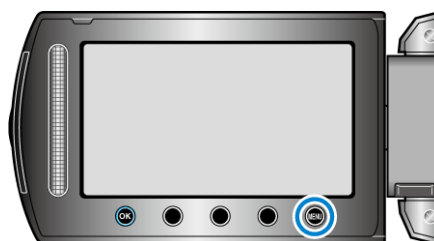

4 Select "DELETE" and touch **OK**.



5 Select "DELETE ALL" and touch **OK**.



6 Select "YES" and touch **OK**.



- After deleting, touch **OK**.

**Memo:**

- When files in a playlist are deleted, the playlist changes.
- Files that are protected cannot be deleted. Release protection before deleting the file.

"Protecting Files" (P.52)

## Protecting Files

Prevent important videos/still images from being deleted accidentally by protecting them.

"Protecting the Currently Displayed File" (P.52)

"Protecting Selected Files" (P.53)

"Protecting All Files" (P.54)

"Releasing Protection of All Files" (P.54)

### CAUTION:

- When the recording media is formatted, even the protected files will be deleted.

### Protecting the Currently Displayed File

Protects or releases protection of the currently displayed file.

1 Select the playback mode.

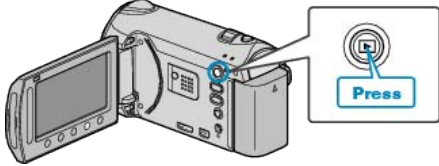

2 Select video or still image mode.

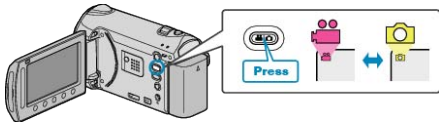

3 Touch  $\odot$  to display the menu.

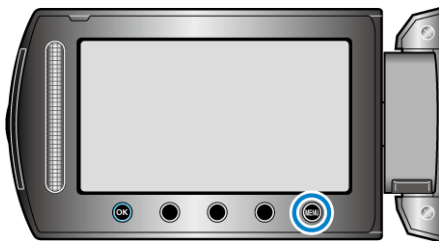

4 Select "EDIT" and touch  $\odot$ .



5 Select "PROTECT/CANCEL" and touch  $\odot$ .



6 Select "CURRENT" and touch  $\odot$ .



7 Check that it is the file to protect or release protection of, select "YES" and touch  $\odot$ .



- The file to protect or release protection of appears on this screen.
- Touch the operation buttons "←" / "→" to select the previous or next file.
- After setting, touch  $\odot$ .
- To exit the screen, touch  $\odot$ .

## Protecting Selected Files

Protects or releases protection of the selected files.

1 Select the playback mode.

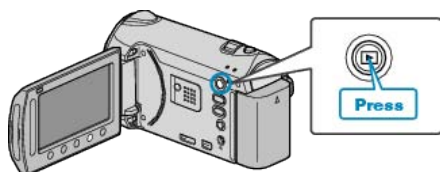

2 Select video or still image mode.

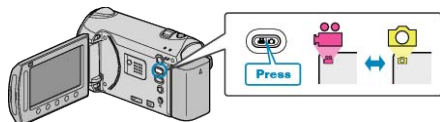

3 Touch **MENU** to display the menu.

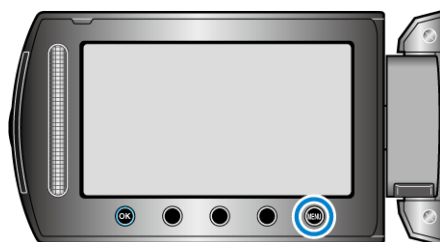

4 Select "EDIT" and touch **OK**.



5 Select "PROTECT/CANCEL" and touch **OK**.



6 Select "FILE SELECT" and touch **OK**.



7 Select the desired file and touch **OK**.



• A **P** mark appears on the selected file.  
To remove the mark, touch **OK** again.

• Touch "CHECK" to check the selected file.

8 After selecting all the files to protect or release protection of, touch **MENU**.



9 Select "YES" and touch **OK**.



### Protecting All Files

Protects all files.

1 Select the playback mode.

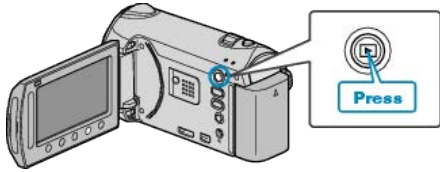

2 Select video or still image mode.

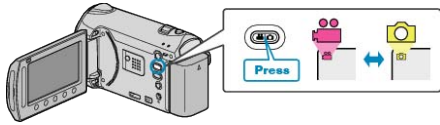

3 Touch **MENU** to display the menu.

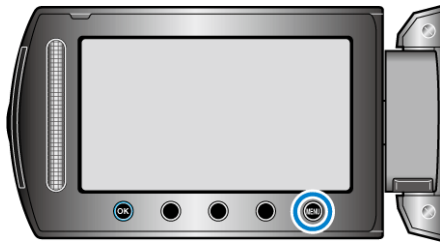

4 Select "EDIT" and touch **OK**.



5 Select "PROTECT/CANCEL" and touch **OK**.



6 Select "PROTECT ALL" and touch **OK**.



7 Select "YES" and touch **OK**.



• After setting, touch **OK**.

### Releasing Protection of All Files

Releases protection of all files.

1 Select the playback mode.

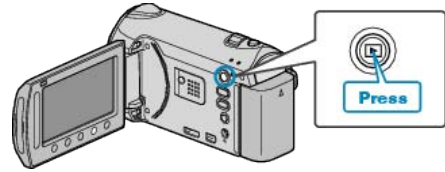

2 Select video or still image mode.

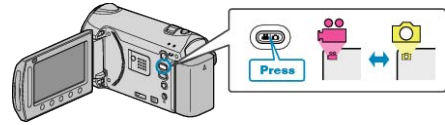

3 Touch **MENU** to display the menu.

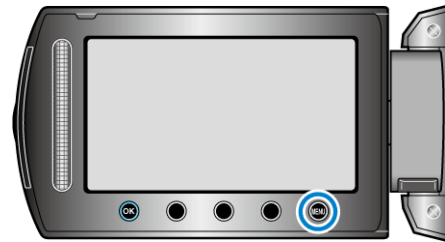

4 Select "EDIT" and touch **OK**.



5 Select "PROTECT/CANCEL" and touch **OK**.



6 Select "CANCEL ALL" and touch **OK**.



7 Select "YES" and touch **OK**.



• After setting, touch **OK**.

## Changing Event Registration of Videos

Find your recorded videos for playback easily by registering them to suitable items from the list of various events.

"Changing the Event of the Currently Displayed File" (P.55)

"Changing the Event of the Selected Files" (P.56)

**Memo:**

- You can also register files to events before recording if the content has been decided.

"Registering Files to Events Before Recording" (P.32)

### Changing the Event of the Currently Displayed File

Checks and changes the event of the currently displayed file.

1 Select the playback mode.

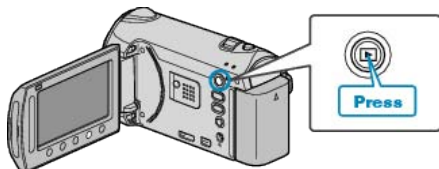

2 Select video mode.

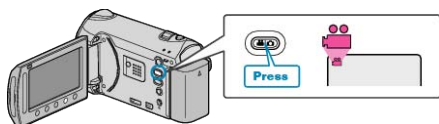

3 Touch **OK** to display the menu.

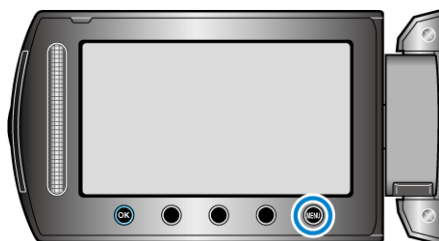

4 Select "EDIT" and touch **OK**.



5 Select "CHANGE EVENT REG." and touch **OK**.



6 Select "CURRENT" and touch **OK**.



7 Select the file you want to register and touch **OK**.



- The file to register appears on this screen.
- Touch the operation buttons "←" / "→" to select the previous or next file.

8 Select a new event and touch **OK**.



- You can cancel the registered event by touching "CANCEL".
- After setting, touch **OK**.
- To exit the screen, touch **EXIT**.



### Changing the Event of the Selected Files

Changes the event of multiple files by specifying a range.

1 Select the playback mode.

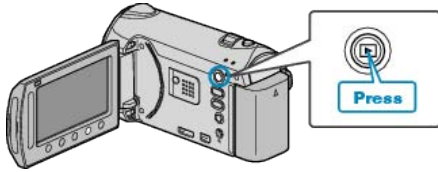

2 Select video mode.

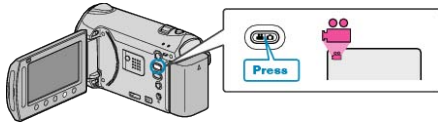

3 Touch **MENU** to display the menu.

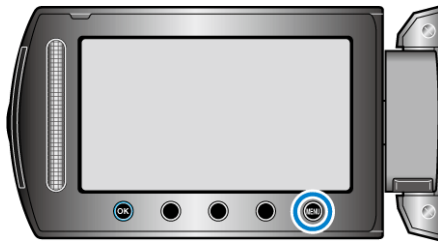

4 Select "EDIT" and touch **OK**.



5 Select "CHANGE EVENT REG." and touch **OK**.



6 Select "TO RESET RANGE" and touch **OK**.



7 Select the first file of the range and touch **OK**.



• Touch "CHECK" to check the selected file.

8 Select the last file of the range and touch **OK**.



• Touch "CHECK" to check the selected file.

9 Select a new event and touch **OK**.



• You can cancel the registered event by touching "CANCEL".

• After setting, touch **OK**.

• To exit the screen, touch **MENU**.

## Dividing Files

You can divide a selected video into two.

1 Select the playback mode.

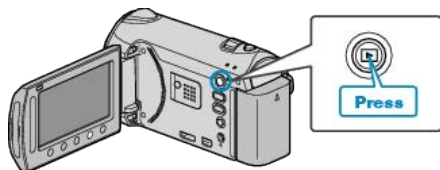

2 Select video mode.

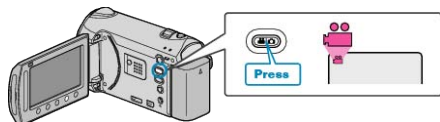

3 Touch  $\odot$  to display the menu.

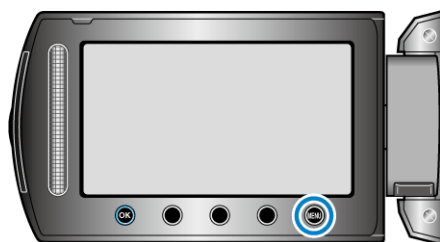

4 Select "EDIT" and touch  $\odot$ .



5 Select "DIVIDE" and touch  $\odot$ .



6 Select the desired file and touch  $\odot$ .



• Playback of the selected video starts.

7 Touch  $\odot$  to pause playback, then touch "SET" at the point you want to divide the file.



• The actual division point may differ slightly from the point that is set.

8 Select "DIVIDE HERE" and touch  $\odot$ .



- To select the division point again, select "CANCEL".
- After dividing, touch  $\odot$ .
- The original video is now replaced by two new videos.

**Memo:**

- When playing back the divided file, the recording date of the division point is displayed.
- You cannot divide the files with the upload or export setting turned on.
- Upload setting is disabled if videos are divided.

## Face Detection Zoom

You can enlarge the part including a face in a still image and save it as a new file.

1 Select the playback mode.

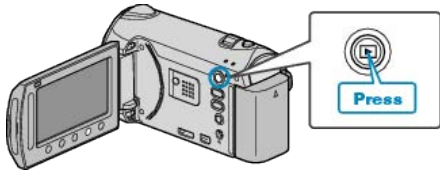

2 Select still image mode.

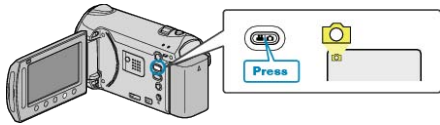

3 Select the desired still image and touch **OK**.



4 Touch **OK**.



- Faces are detected.

5 Select the face to zoom and touch **OK**.



- The face that is highlighted in red is zoomed in.

6 Touch **OK** repeatedly to change the zoom ratio.



- To adjust/change zoom area, touch the slider.

7 Touch "SAVE".



- Zoom images are saved in 16:9 aspect regardless of the original aspect.

8 Select "YES" and touch **OK**.



- After saving, touch **OK**.

## Capturing a Still Image in the Video during Playback

You can capture still images of the scenes you like in the recorded videos.

1 Select the playback mode.

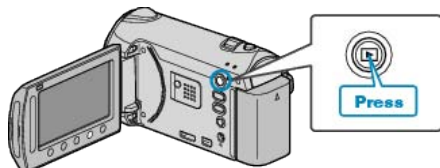

2 Select video mode.

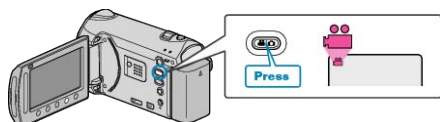

3 Select the desired video and touch OK.



4 Touch pause at the desired scene during playback.



- After pausing the video, you can fine-tune the point to capture by using the forward slow-motion and reverse slow-motion operation buttons.

5 Capture a still image.

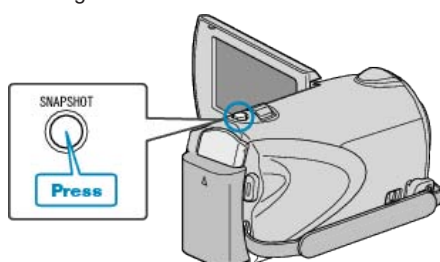

### Memo:

- The picture quality varies with the "IMAGE QUALITY" setting. "IMAGE QUALITY" (P.106)
- Captured still images are stored in the media specified in "REC MEDIA FOR IMAGE".

"REC MEDIA FOR IMAGE (GZ-HM350/GZ-HM330)" (P.128)

"IMAGE SLOT SELECTION (GZ-HM300)" (P.128)

## Capturing a Required Part in the Video

Select the required part of a video and save it as a new video file.

1 Select the playback mode.

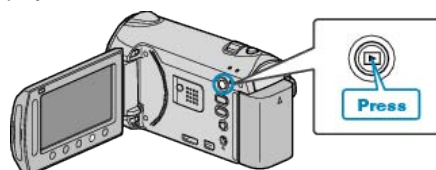

2 Select video mode.

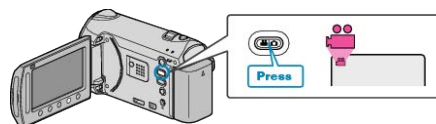

3 Touch MENU to display the menu.

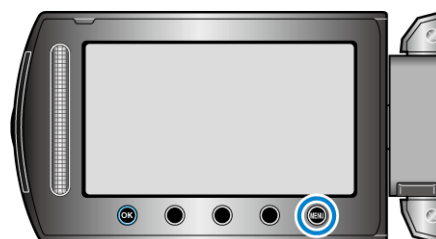

4 Select "EDIT" and touch OK.



5 Select "TRIMMING" and touch OK.



6 Select the desired video and touch OK.



- Playback of the selected video starts.

7 Touch OK to pause playback, then touch "SET" to set the start point.





- Touch **OK** to resume playback.  
"Playing Back Videos" (P.40)

- 8 Touch **OK** to pause playback, then touch "SET" to set the point to stop copying.



- To reset the start point, touch CANCEL.

- 9 Select "CAPTURE TRIMMED FILE" and touch **OK**.



- To set the start/end point again, select "RESET AREA".

- 10 Select "YES" and touch **OK**.



- After copying, touch **OK**.
- When copying finishes, the copied file is added to the index screen.

**Memo:**

- According to the AVCHD standard, videos are split into units of approximately 0.5 second.  
As such, the division point may not be accurate.

## Capturing Videos for Uploading to YouTube™

Capture and copy a part of a recorded video (maximum 10 minutes) for uploading to YouTube™, and save it as a YouTube™ video. When capturing videos for YouTube™, the duration cannot be longer than 10 minutes.

- 1 Select the playback mode.

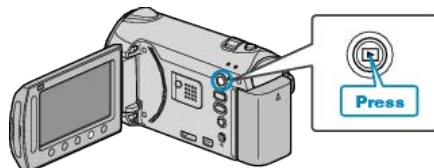

- 2 Select video mode.

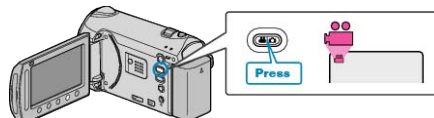

- 3 GZ-HM350/GZ-HM330

Press the UPLOAD/EXPORT button to display the "UPLOAD SETTINGS"/"EXPORT SETTINGS" menu.

GZ-HM300

Press the UPLOAD button. Go to step 5.

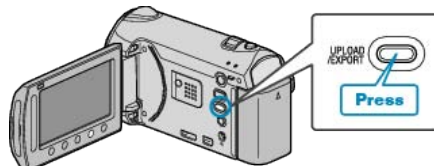

- 4 Select "UPLOAD SETTINGS" and touch **OK**.



- 5 Select the desired video and touch **OK**.



- 6 Select "TRIM" and touch **OK**.

- When trimming is not necessary, select "DO NOT TRIM" and touch **OK** to complete the setting.



- If the selected video is more than 10 minutes, trimming is necessary.

- 7 Touch **OK** to pause playback, then touch "SET" to set the start point to copy.





- Resume playback after setting the start point.  
"Playing Back Videos" (P.40)

8 Touch **OK** to pause playback, then touch "SET" to set the point to stop copying.



- To reset the start point, touch "CANCEL".

9 Select "CAPTURE TRIMMED FILE" and touch **OK**.



- To set the start/end point again, select "RESET AREA".

10 Select "YES" and touch **OK**.



- When copying finishes, the copied file is added to the index screen.
- After copying, touch **OK**.
- To exit the screen, touch **MENU**, select "YES" and touch **OK**.

**Memo:**

- According to the AVCHD standard, videos are split into units of approximately 0.5 second.  
As such, the division point may not be accurate.
- You can take videos in YouTube™ format by setting upload shooting before recording.

"Taking Videos in YouTube™ Format" (P.33)

**Uploading Videos to YouTube™**

You can upload your videos to YouTube™ using the provided software "Everio MediaBrowser". Install the software on your PC and connect this unit to the PC.

- For details on how to use the software, refer to the help file.

"Installing the Provided Software" (P.88)

"Copying to Windows PC" (P.88)

Trouble with Uploading Videos :

- Check if you have created an account with YouTube™. (You need a YouTube™ account to upload files to YouTube™.)
- Refer to "Q&A", "Latest Information", "Download Information", etc. in "Click for Latest Product Info" in the help file of the provided software "Everio MediaBrowser".

**Preparing Videos to Transfer to iTunes (GZ-HM350/GZ-HM330)**

Set EXPORT attributes to the recorded videos by adding a "LIB." mark. When EXPORT attributes are set, the videos can be registered to iTunes easily using the supplied software on a PC.

1 Select the playback mode.

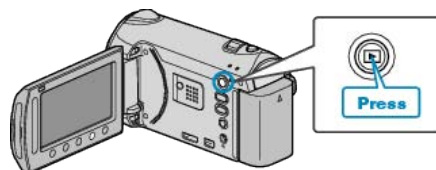

2 Select video mode.

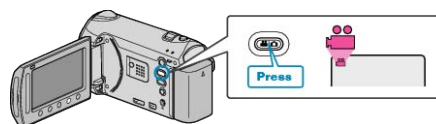

3 Press the UPLOAD/EXPORT button to display the "UPLOAD SETTINGS"/"EXPORT SETTINGS" menu.

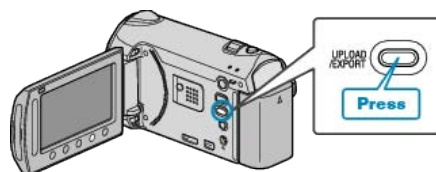

4 Select "EXPORT SETTINGS" and touch the **OK** button.



5 Select the desired video and touch **OK**.



- A "LIB." mark appears on the selected file.  
To remove the "LIB." mark, touch **OK** again.
- Touch "CHECK" to check the selected file.

6 After selecting all the files, touch **MENU**.



- To exit the screen, select "YES" and touch **OK**.

**Memo:** \_\_\_\_\_

- You can take videos in iTunes format by setting EXPORT shooting before recording.
- "Taking Videos in iTunes Format (GZ-HM350/GZ-HM330)" (P.34)
- The format of recorded videos changes when they are transferred to a PC using the supplied software.  
Files that are stored on this unit will not be affected.
- The "LIB." mark does not appear on other index screens.

**Transferring Converted Videos to iPod**

You can export videos to iTunes using the provided software "Everio MediaBrowser".

Install the software on your PC and connect this unit to the PC.

- For details on how to use the software, refer to the help file.
- For details on transferring files to iPod, refer to the help file of iTunes.

"Installing the Provided Software" (P.88)

"Backing Up All Files" (P.89)

**Trouble with Exporting Files to iTunes :** \_\_\_\_\_

- Refer to "Q&A", "Latest Information", "Download Information", etc. in "Click for Latest Product Info" in the help file of the provided software "Everio MediaBrowser".

**Creating a Playlist with Title (GZ-HM350/GZ-HM330)**

Create a playlist simply by selecting a recording date and a title screen from the list.

1 Select the playback mode.

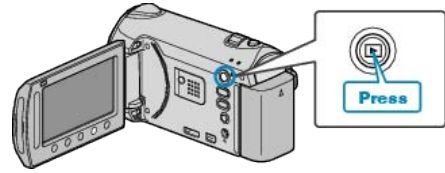

2 Select video mode.

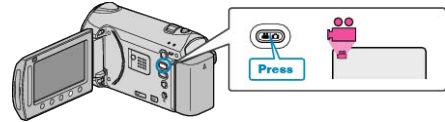

3 Touch **Ⓜ** to display the menu.

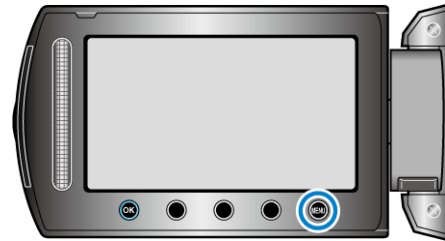

4 Select "PICTURE TITLE" and touch **Ⓚ**.



5 Select a title and touch **Ⓚ**.



- Touch "CHECK" to check the title.

6 Select the desired recording date and touch **OK**.



- Touch "CHECK" to check the selected video.
- After setting, touch **OK**.

Picture Title
A Great Memory
Happy Anniversary
Business
Celebration
Congratulations
Graduation
Happy Birthday
Happy Father's Day
Happy Mother's Day
Holiday
Happy New Year!
Happy Valentine's Day
Our Baby
Our Family
Sight Seeing
Vacation
School Memories
Season's Greetings
Sports
Wedding

**Memo:**

- Play back the DVD created from a playlist with title on a DVD player. The title will not be played back if you connect this unit to a DVD writer (optional).
- To add a title to a playlist that is already created, refer to the following. "Adding Title Screens to Playlists (GZ-HM350/GZ-HM330)" (P.69)

## Creating Playlists from the Recorded Videos

A list created by selecting your favorite videos from the recorded ones is called a playlist.

By creating a playlist, you can play back only your favorite videos in the order you like.

The original video file remains even when it is registered to a playlist.

- To create a new playlist
  - "Creating Playlists with Selected Files" (P.63)
  - "Creating Playlists by Group" (P.64)
  - "Creating Playlists by Date" (P.65)
  - "Creating Playlists by Event" (P.66)
- To edit or delete a created playlist
  - "Editing Playlists" (P.67)
  - "Deleting Playlists" (P.68)
  - "Adding Title Screens to Playlists (GZ-HM350/GZ-HM330)" (P.69)

**Memo:**

- When a video file is deleted or moved, the same file will be removed from the playlist.
- The playlist will not be affected when a registered video file is divided. However, if any one of the divided video files is deleted or moved, the original file will be removed from the playlist.
- A maximum of 99 playlists can be created.

### Creating Playlists with Selected Files

Create a playlist by arranging the files one by one.

1 Select the playback mode.

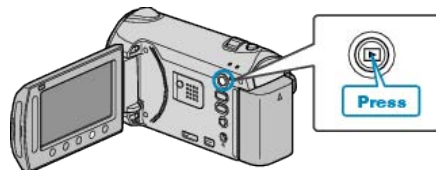

2 Select video mode.

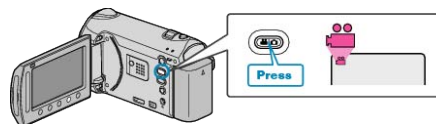

3 Touch **MENU** to display the menu.

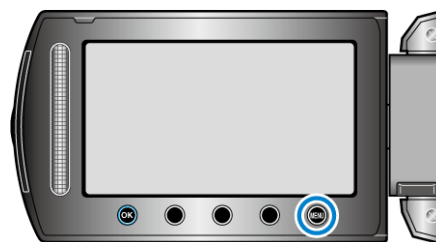

4 Select "EDIT PLAYLIST" and touch **OK**.



5 Select "NEW LIST" and touch **OK**.



6 Select "CREATE FROM SCENE" and touch **OK**.



7 Select the file to add to playlist and touch **OK**.



- Touch "CHECK" to check the selected video.

8 Select the insertion point and touch **OK**.



- The selected videos are added to the playlist on the right.
- To delete a video from the playlist, touch "→" to select the video and touch **OK**.
- Repeat steps 7-8 and arrange the videos in the playlist.

9 After arranging, touch **MEMO**.



10 Select "SAVE AND THEN QUIT" and touch **OK**.



## Creating Playlists by Group

Create a playlist by arranging multiple files according to group.

1 Select the playback mode.

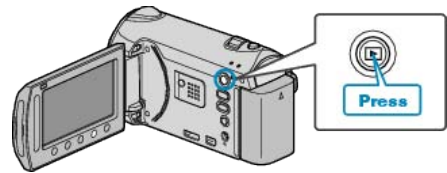

2 Select video mode.

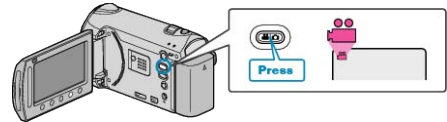

3 Touch **MEMO** to display the menu.

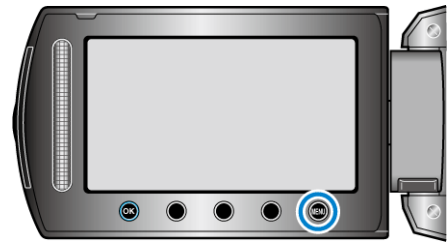

4 Select "EDIT PLAYLIST" and touch **OK**.



5 Select "NEW LIST" and touch **OK**.



6 Select "CREATE BY GROUP" and touch **OK**.



7 Select the group to add to playlist and touch **OK**.



- Touch "CHECK" to check the selected video.



8 Select the insertion point and touch **OK**.



- The selected videos are added to the playlist on the right.
- To delete a video from the playlist, touch "→" to select the video and touch **OK**.
- Repeat steps 7-8 and arrange the videos in the playlist.

9 After arranging, touch **MENU**.



10 Select "SAVE AND THEN QUIT" and touch **OK**.



### Creating Playlists by Date

Create a playlist by arranging multiple files according to recording date.

1 Select the playback mode.

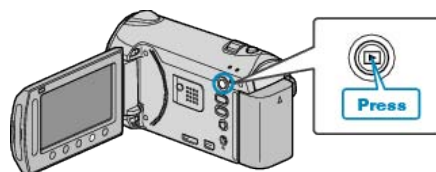

2 Select video mode.

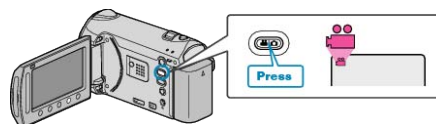

3 Touch **MENU** to display the menu.

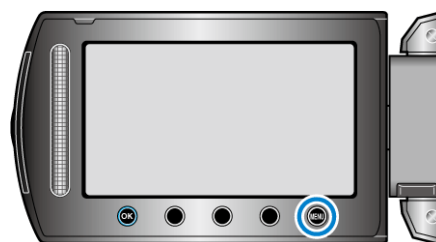

4 Select "EDIT PLAYLIST" and touch **OK**.



5 Select "NEW LIST" and touch **OK**.



6 Select "CREATE BY DATE" and touch **OK**.



7 Select the recording date to add to playlist and touch **OK**.





- Touch "CHECK" to check the selected video.



8 Select the insertion point and touch .



- The selected videos are added to the playlist on the right.
- To delete a video from the playlist, touch "→" to select the video and touch .
- Repeat steps 7-8 and arrange the videos in the playlist.

9 After arranging, touch .



10 Select "SAVE AND THEN QUIT" and touch .



### Creating Playlists by Event

Create a playlist by arranging multiple files according to events and recording dates.

1 Select the playback mode.

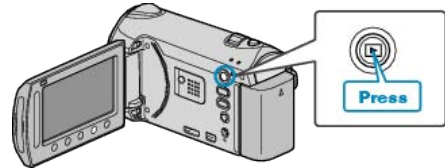

2 Select video mode.

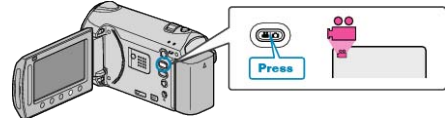

3 Touch  to display the menu.

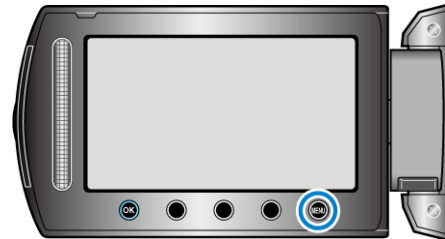

4 Select "EDIT PLAYLIST" and touch .



5 Select "NEW LIST" and touch .



6 Select "CREATE BY EVENT" and touch .



7 Select an event and touch .



8 Select the recording date to add to playlist and touch **OK**.



- Touch "CHECK" to check the selected video.

9 Select the insertion point and touch **OK**.



- The selected videos are added to the playlist on the right.
- To delete a video from the playlist, touch "→" to select the video and touch **OK**.
- Repeat steps 8-9 and arrange the videos in the playlist.

10 After arranging, touch **Menu**.



11 Select "SAVE AND THEN QUIT" and touch **OK**.



## Editing Playlists

You can change the content of a created playlist.

1 Select the playback mode.

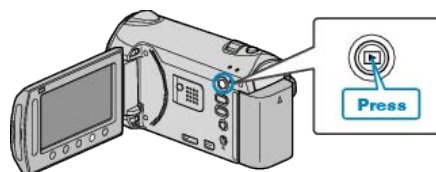

2 Select video mode.

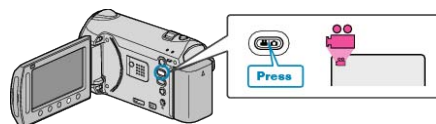

3 Touch **Menu** to display the menu.

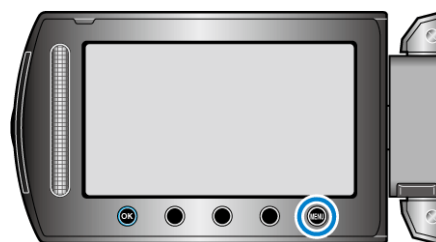

4 Select "EDIT PLAYLIST" and touch **OK**.



5 Select "EDIT" and touch **OK**.



6 Select the playlist you want to edit and touch **OK**.



7 Select the file to add to playlist and touch **OK**.



- Touch "CHECK" to check the selected video.

8 Select the insertion point and touch .



- The selected videos are added to the playlist on the right.
- To delete a video from the playlist, touch "→" to select the video and touch .
- Repeat steps 7-8 and arrange the videos in the playlist.

9 After arranging, touch .



10 Select "SAVE AND THEN QUIT" and touch .



### Deleting Playlists

Delete the playlists that you have created.

1 Select the playback mode.

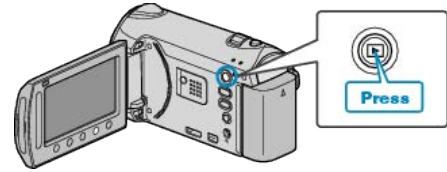

2 Select video mode.

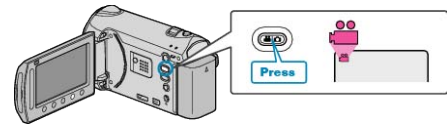

3 Touch  to display the menu.

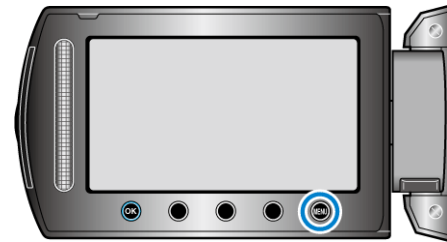

4 Select "EDIT PLAYLIST" and touch .



5 Select "DELETE" and touch .



6 Select the playlist you want to delete and touch .



- All created playlists will be deleted when "DELETE ALL" is selected.

7 Select "YES" and touch .



- After deleting, touch .

- To exit the screen, touch .

### Adding Title Screens to Playlists (GZ-HM350/GZ-HM330)

Add a title screen to a created playlist.

- 1 Select the playback mode.

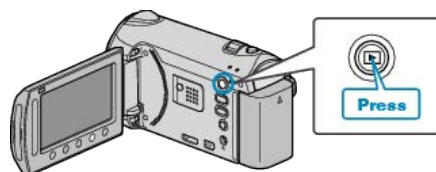

- 2 Select video mode.

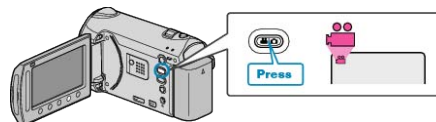

- 3 Touch  to display the menu.

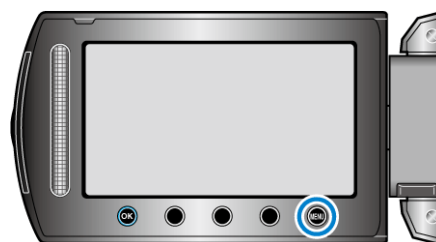

- 4 Select "EDIT PLAYLIST" and touch .



- 5 Select "SET TITLE" and touch .



- 6 Select the desired playlist and touch .



- Touch "CHECK" to check the content of the selected playlist.

- 7 Select a title and touch .



- Touch "CHECK" to check the title.

- To delete the title, select "NO TITLE".
- After setting, touch **OK**.
- To exit the screen, touch **MENU**.

## Combining Videos Recorded by Seamless Recording

Videos that are recorded on two separate media and with "SEAMLESS RECORDING" in the video recording menu enabled can be combined into a single video.

1 Select the playback mode.

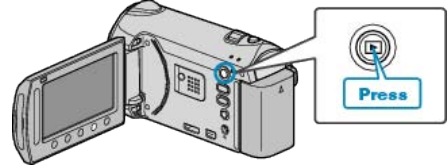

2 Select video mode.

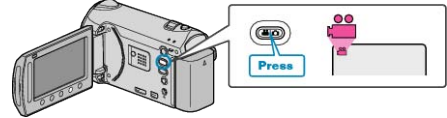

3 Touch **MENU** to display the menu.

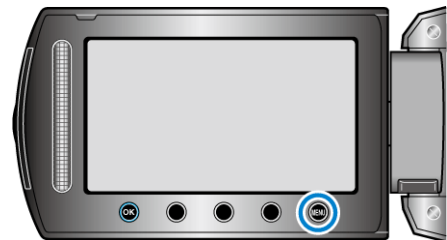

4 Select "SEAMLESS REC CTRL" and touch **OK**.



5 Select "COMBINE SCENES" and touch **OK**.



- This unit starts a search to detect seamless videos. Combining cannot be performed if no seamless videos are found.

6 Select "YES" and touch **OK**.



7 Select the media to store the combined video and touch **OK**.





8 Select "YES" and touch **OK**.



- Combining of the videos starts.
- After videos are combined, touch **OK**.

**Memo:**

- Seamless videos cannot be combined when there is not enough free space in the built-in memory or SD card. Make sure that enough free space is left before combining seamless videos.
- Scenes from seamless recording can no longer be combined if the files are divided, deleted, trimmed, or moved.

### How to Enable Seamless Video Recording Again

To start seamless recording again after the previous session is complete, it is necessary to combine seamless videos, or delete the combination information of the seamless videos.

To delete the combination information of seamless videos, select "DEL SCENE COMBI INFO" in step 5.

Select "DEL SCENE COMBI INFO" in the respective media to delete the combination information of seamless videos. Icons are removed from the files.

**Memo:**

**GZ-HM300**

**You can create only AVCHD discs using the provided application software.**

To create DVD-Video discs, refer to "Dubbing Files to a DVD Recorder or VCR" (P.87) .

Using the optional application software, you can create DVD-Video and BD discs on a computer.

Download the optional software here

[http://www.pixela.co.jp/oem/jvc/mediabrowser/e/purchase\\_dl/media-browser\\_hd\\_2/](http://www.pixela.co.jp/oem/jvc/mediabrowser/e/purchase_dl/media-browser_hd_2/)

## Copying Files to Card

You can copy videos and still images from the built-in memory or SD card to another media.

Copying still images to SD cards makes it convenient to bring them to the shop for printing (developing).

"Copying All Files" (P.72)

"Copying Selected Files" (P.73)

### CAUTION:

- Make sure that there is enough space left in the destination medium.

### Copying All Files

Copies all videos and still images to another media.

- 1 Select the playback mode.

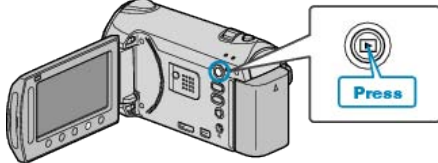

- 2 Select video or still image mode.

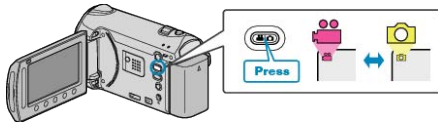

- 3 Touch **Ⓜ** to display the menu.

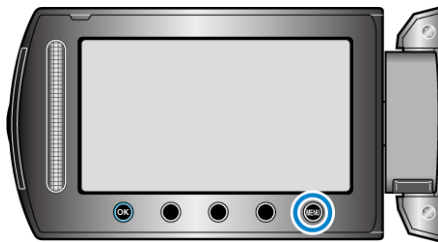

- 4 Select "EDIT" and touch **Ⓜ**.



- 5 Select "COPY" and touch **Ⓜ**.



- 6 Select the direction of copying and touch **Ⓜ**.



(GZ-HM350/GZ-HM330)



(GZ-HM300)

- The direction of copying varies with the model.

- 7 Select "COPY ALL" and touch **Ⓜ**.



- 8 Select "YES" and touch **Ⓜ**.



- Copying starts.
- After copying, touch **Ⓜ**.

### Copying Selected Files

Copies selected videos and still images to another media.

1 Select the playback mode.

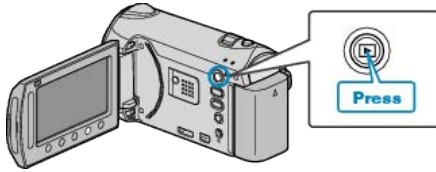

2 Select video or still image mode.

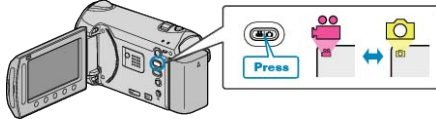

3 Touch **OK** to display the menu.

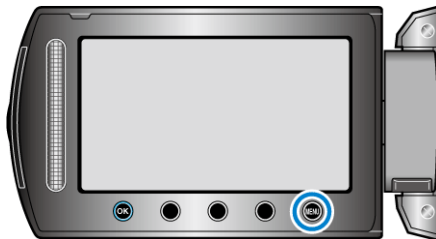

4 Select "EDIT" and touch **OK**.



5 Select "COPY" and touch **OK**.



6 Select the direction of copying and touch **OK**.



(GZ-HM350/GZ-HM330)



(GZ-HM300)

• The direction of copying varies with the model.

7 Select "SELECT AND COPY" and touch **OK**.



8 Select the desired file and touch **OK**.



• A check mark appears on the selected file.  
To remove the check mark, touch **OK** again.

9 After selecting all the files to copy, touch "EXEC".



10 Select "YES" and touch **OK**.



• Copying starts.  
• After copying, touch **OK**.

## Moving Files

You can move videos and still images from the built-in memory or SD card to another media.

Files that are moved will be deleted from the original media.

Moving still images to SD cards makes it convenient to bring them to the shop for printing (developing).

"Moving All Files" (P.74)

"Moving Selected Files" (P.75)

### CAUTION:

- Make sure that there is enough space left in the destination medium.

### Moving All Files

Moves all videos and still images to another media.

Files that are moved will be deleted from the original media.

Files with a protect mark will not be deleted from the original media.

- 1 Select the playback mode.

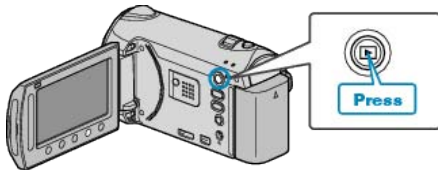

- 2 Select video or still image mode.

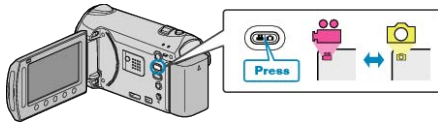

- 3 Touch  $\odot$  to display the menu.

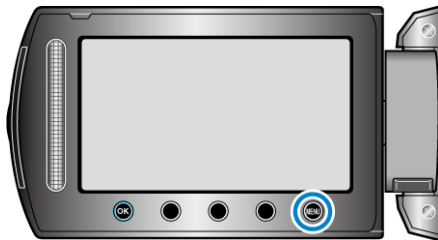

- 4 Select "EDIT" and touch  $\odot$ .



- 5 Select "MOVE" and touch  $\odot$ .



- 6 Select the direction of moving and touch  $\odot$ .



(GZ-HM350/GZ-HM330)



(GZ-HM300)

- The direction of moving varies with the model.

- 7 Select "MOVE ALL" and touch  $\odot$ .



- 8 Select "YES" and touch  $\odot$ .



- Moving of files starts.
- After moving, touch  $\odot$ .



### Moving Selected Files

Moves selected videos and still images to another media. Files that are moved will be deleted from the original media.

1 Select the playback mode.

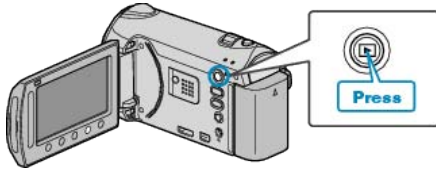

2 Select video or still image mode.

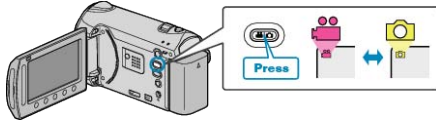

3 Touch **OK** to display the menu.

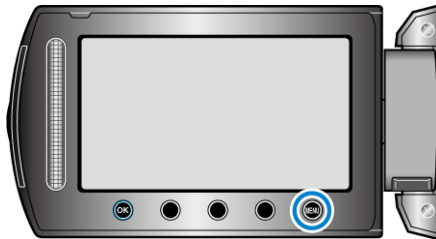

4 Select "EDIT" and touch **OK**.



5 Select "MOVE" and touch **OK**.



6 Select the direction of moving and touch **OK**.



(GZ-HM350/GZ-HM330)



(GZ-HM300)

• The direction of moving varies with the model.

7 Select "SELECT AND MOVE" and touch **OK**.



8 Select the desired file and touch **OK**.



• A check mark appears on the selected file. To remove the check mark, touch **OK** again.

9 After selecting all the files to move, touch EXEC.



10 Select "YES" and touch **OK**.



• Moving of files starts.  
• After moving, touch **OK**.

## Creating Discs with a BD/DVD Writer (GZ-HM350/GZ-HM330)

You can copy the recorded files to discs using an optional BD/DVD writer.

### Compatible BD/DVD Writers

Product Name	Description
DVD Writer • CU-VD3	<ul style="list-style-type: none"> <li>Enables the images recorded on this unit to be copied to a DVD without using a PC.</li> </ul>
DVD Writer • CU-VD50	<ul style="list-style-type: none"> <li>Creates DVDs and functions as an external DVD drive when connected to a PC. In addition, created DVDs can be played back by connecting the CU-VD50 to a TV.</li> </ul>
BD Writer • LG Model No.BE06LU10	<ul style="list-style-type: none"> <li>Enables the images recorded on this unit to be copied to a BD without using a PC.</li> </ul>

### Creating Discs with a BD/DVD Writer

#### ■ Preparing a BD/DVD Writer

"Preparing a DVD Writer (CU-VD50)" (P.76)

"Preparing a DVD Writer (CU-VD3)" (P.77)

"Preparing a BD Writer" (P.77)

#### ■ Copying to BD/DVD

"Copying All Files" (P.78)

"Copying Files by Date" (P.79)

"Copying Files by Event (video mode only)" (P.80)

"Copying Selected Playlists (video mode only)" (P.81)

"Copying Selected Files" (P.82)

#### ■ Other Operations

"Playing Back Files" (P.83)

"Finalizing Discs After Copying" (P.83)

"Changing Recording Media (video mode only)" (P.83)

#### Memo:

- The recordable time on the BD/DVD varies according to the way of recording.

### Preparing a DVD Writer (CU-VD50)

1 Connect the USB cable and AC adapter.

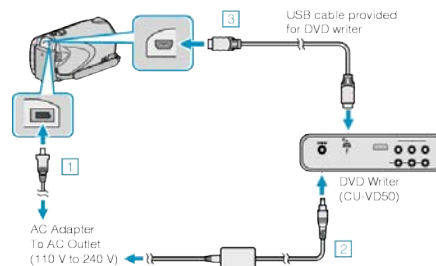

- Connect the AC adapter to this unit.
  - Connect the AC adapter of the DVD writer.
  - Connect the USB cable provided with the DVD writer.
- Refer also to the instruction manual of the DVD writer.

2 Turn on the DVD writer and insert a new disc.



- Press the power button to turn on the power.
- Press the eject button to open the disc tray.
- Pull out the tray completely and load a new disc properly.
- Push the disc tray in until it clicks into place.

3 Open the LCD monitor.

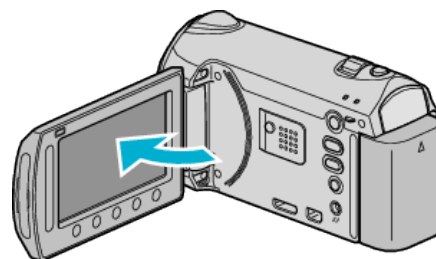

- The CREATE DVD menu appears.
- While the USB cable is connected, the CREATE DVD menu is displayed.

#### CAUTION:

- Be sure to turn off the power when connecting the devices. Otherwise, electric shocks or malfunctions may occur.

#### Memo:

- When connected to this unit, all buttons on the DVD writer CU-VD50, other than the power and eject buttons, will not work.

### Preparing a DVD Writer (CU-VD3)

1 Connect the USB cable and AC adapter.

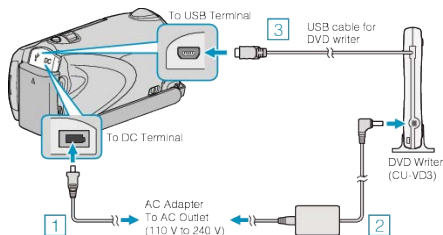

- ① Connect the AC adapter to this unit.
- ② Connect the AC adapter of the DVD writer.
- ③ Connect the USB cable provided with the DVD writer to this unit.

• Refer also to the instruction manual of the DVD writer.

2 Insert a new disc.

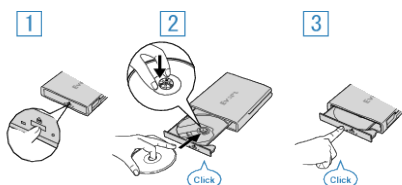

- ① Press the eject button to open the disc tray.
- ② Pull out the tray completely and load a new disc properly.
- ③ Push the disc tray in until it clicks into place.

3 Open the LCD monitor.

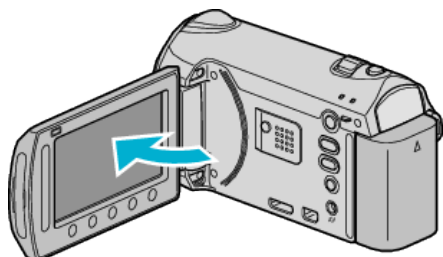

- The CREATE DVD menu appears.
- While the USB cable is connected, the CREATE DVD menu is displayed.

**CAUTION:**

- Be sure to turn off the power when connecting the devices. Otherwise, electric shocks or malfunctions may occur.

### Preparing a BD Writer

**Memo:**

When connecting to the external Blu-ray drive, use a USB cable with Mini-A (Male) – B (Male) connectors. The USB cable bundled with this camera cannot be used. To use the USB cable provided with the external Blu-ray drive, purchase the USB extension cable.

- Mini-A (Male) – A (Female)  
(Part number: QAM0852-001)

1 Connect the USB cable and AC adapter.

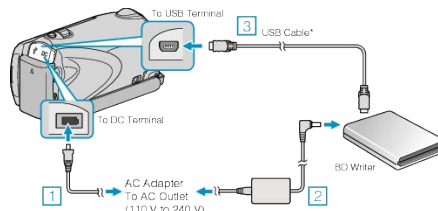

- ① Connect the AC adapter to this unit.
- ② Connect the AC adapter of the BD writer.
- ③ Connect the USB cable of the BD writer to this unit.

• Refer also to the instruction manual of the BD writer.

2 Insert a new disc.

• Press the power button on the BD writer to turn on the power.

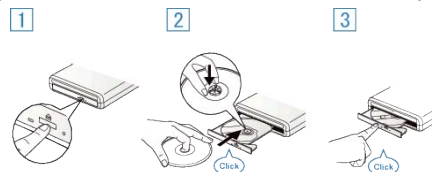

- ① Press the eject button to open the disc tray.
- ② Pull out the tray completely and load a new disc properly.
- ③ Push the disc tray in until it clicks into place.

3 Open the LCD monitor.

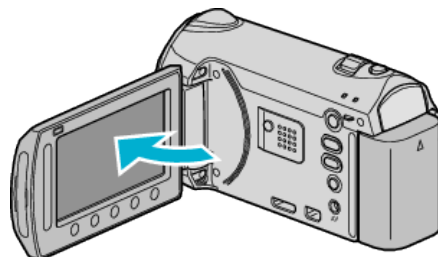

- The CREATE DVD menu appears.
- While the USB cable is connected, the CREATE DVD menu is displayed.

**CAUTION:**

- Be sure to turn off the power when connecting the devices. Otherwise, electric shocks or malfunctions may occur.

**Selecting the Quality for Saving to Discs (CHANGE REC. MEDIA)**

Set the type and video quality of the disc to be created using a BD/DVD writer. Adjustment is necessary when making DVDs with a BD writer or DVDs in standard quality with a DVD writer.

1 Select video mode.

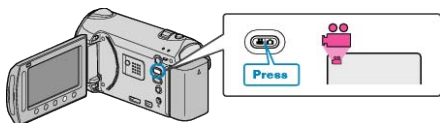

2 Select "CHANGE REC. MEDIA" and touch **OK**.



**Backing Up Videos with a DVD Writer**

Setting	Details
DVD(AVCHD)	Saves videos in a DVD in the high-definition quality.
DVD-Video	Saves videos in a DVD after converting to the standard image quality.

**Backing Up Videos with a BD Writer**

Setting	Details
Blu-ray DISC	Saves videos in a BD in the high-definition quality.
DVD(AVCHD)	Saves videos in a DVD in the high-definition quality.
DVD-Video	Saves videos in a DVD after converting to the standard image quality.

Cautions when Backing Up in the DVD-Video Format :

- It takes about 1.2 times the recording time to convert a video from high-definition to standard image quality. (The original video remains in high-definition quality.)
- Each scene is saved as a chapter. The video pauses at the switching of scenes, but this is not a malfunction.
- Videos cannot be saved to DVD-R DL (double layer) discs. Use a DVD-R or DVD-RW disc.

**Memo:**

- DVDs that are created with "DVD-Video" selected can be played back on normal DVD players.
- When backing up still images, "Blu-ray DISC" or "DVD" can be selected. Image quality of the still images will not be changed.

**Copying All Files**

All files recorded on this unit will be copied. You can also select and copy only the files that have never been copied.

1 Select video or still image mode.

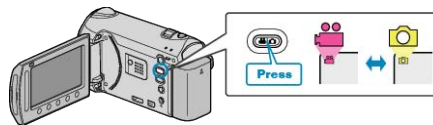

2 Select "CREATE FROM ALL"/"SAVE ALL" and touch **OK**.



3 Select the media for copying and touch **OK**.



4 Select the desired menu and touch **OK**.



Setting	Details
<ul style="list-style-type: none"> <li>• "ALL SCENES"</li> <li>• "ALL IMAGES"</li> </ul>	All files in the recording medium are copied.
<ul style="list-style-type: none"> <li>• "UNSAVED SCENES"</li> <li>• "UNSAVED IMAGES"</li> </ul>	Files that have never been copied are automatically selected and copied.

5 Select "EXECUTE" and touch **OK**.



6 Select "YES" or "NO" and touch **OK**. (P mode only)



- When "YES" is selected, videos with similar recording dates are displayed in groups.



- When “NO” is selected, videos are displayed according to recording dates.

7 Select “EXECUTE” and touch **OK**.



- When “INSERT NEXT DISC” appears, change the disc.
- After copying, touch **OK**.

8 Close the LCD monitor, then disconnect the USB cable.

**CAUTION:**

- Do not turn off the power or remove the USB cable until copying is complete.
- Files that are not on the index screen during playback cannot be copied.

**Copying Files by Date**

Files are sorted and copied according to the date on which they were recorded.

1 Select video or still image mode.

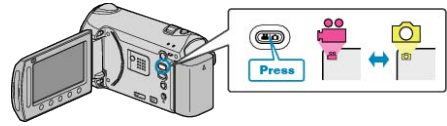

2 Select “SELECT AND CREATE”/“SELECT AND SAVE” and touch **OK**.



3 Select the media for copying and touch **OK**.



4 Select “CREATE BY DATE”/“SAVE BY DATE” and touch **OK**.



5 Select the desired recording date and touch **OK**.



6 Select “EXECUTE” and touch **OK**.



- The number of discs required to copy the files is displayed. Prepare the discs accordingly.
  - Touch “CHECK” to check the file to copy.
- 7 Select “YES” or “NO” and touch **OK**. (M mode only)



- When “YES” is selected, videos with similar recording dates are displayed in groups.
- When “NO” is selected, videos are displayed according to recording dates.

8 Select “EXECUTE” and touch **OK**.



- When “INSERT NEXT DISC” appears, change the disc.
- After copying, touch **OK**.

9 Close the LCD monitor, then disconnect the USB cable.

**CAUTION:**

- Do not turn off the power or remove the USB cable until copying is complete.
- Files that are not on the index screen during playback cannot be copied.

## Copying Files by Event (video mode only)

Videos are sorted and copied according to the registered event.

1 Select video mode.

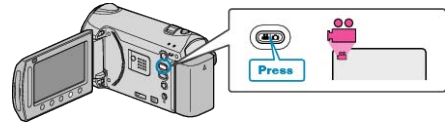

2 Select “SELECT AND CREATE” and touch **OK**.



3 Select the media for copying and touch **OK**.



4 Select “CREATE BY EVENT” and touch **OK**.



5 Select the desired event and touch **OK**.



6 Select “EXECUTE” and touch **OK**.



- The number of discs required to copy the files is displayed. Prepare the discs accordingly.
  - Touch “CHECK” to check the file to copy.
- 7 Select “YES” or “NO” and touch **OK**.



- When "YES" is selected, videos with similar recording dates are displayed in groups.
- When "NO" is selected, videos are displayed according to recording dates.

8 Select "EXECUTE" and touch **OK**.



- When "INSERT NEXT DISC" appears, change the disc.
- After copying, touch **OK**.

9 Close the LCD monitor, then disconnect the USB cable.

**CAUTION:**

- Do not turn off the power or remove the USB cable until copying is complete.
- Files that are not on the index screen during playback cannot be copied.

**Memo:**

- To register files to events  
 "Registering Files to Events Before Recording" (P.32)  
 "Changing Event Registration of Videos" (P.55)

**Copying Selected Playlists (video mode only)**

Arrange and copy the created playlists in the order you like.

1 Select video mode.

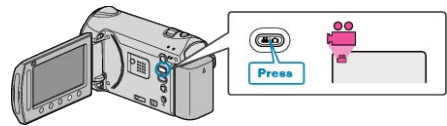

2 Select "SELECT AND CREATE" and touch **OK**.



3 Select the media for copying and touch **OK**.



4 Select "CREATE BY PLAYLIST" and touch **OK**.



5 Select the desired videos and touch **OK**.



- Touch "CHECK" to check the selected video.

6 Select the insertion point and touch **OK**.



- The selected videos are added to the playlist on the right.
- To delete a video from the playlist, touch "→" to select the video and touch **OK**.
- Repeat steps 5-6 and arrange the videos in the playlist.

7 After arranging, touch "SAVE".



- The positions of the "←"/"→" and "SAVE" operation buttons may change according to the position of the cursor.

8 Select "EXECUTE" and touch **OK**.



- The number of discs required to copy the files is displayed. Prepare the discs accordingly.
- Touch "CHECK" to check the file to copy.

9 Touch **OK**.



10 Select "EXECUTE" and touch **OK**.



- When "INSERT NEXT DISC" appears, change the disc.
- After copying, touch **OK**.

11 Close the LCD monitor, then disconnect the USB cable.

### CAUTION:

- Do not turn off the power or remove the USB cable until copying is complete.
- Files that are not on the index screen during playback cannot be copied.

### Memo:

- A list of playlists is displayed on the top menu of the created DVD.
- To create a playlist

"Creating Playlists from the Recorded Videos" (P.63)

"Creating a Playlist with Title (GZ-HM350/GZ-HM330)" (P.62)

## Copying Selected Files

Select and copy the desired files.

1 Select video or still image mode.

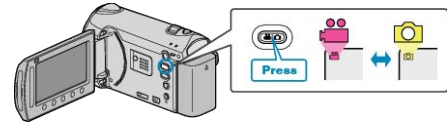

2 Select "SELECT AND CREATE"/"SELECT AND SAVE" and touch **OK**.



3 Select the media for copying and touch **OK**.



4 Select "SELECT FROM SCENES"/"SELECT FROM IMAGES" and touch **OK**.



5 Select the desired files and touch **OK**.



- A check mark appears on the selected file. To remove the check mark, touch **OK**.
- Touch "CHECK" to check the video.

6 After selecting, touch "SAVE".



7 Select "EXECUTE" and touch **OK**.





- The number of discs required to copy the files is displayed. Prepare the discs accordingly.

8 Select "YES" or "NO" and touch **OK**. (👤 mode only)



- When "YES" is selected, videos with similar recording dates are displayed in groups.
- When "NO" is selected, videos are displayed according to recording dates.

9 Select "EXECUTE" and touch **OK**.



- When "INSERT NEXT DISC" appears, change the disc.
- After copying, touch **OK**.

10 Close the LCD monitor, then disconnect the USB cable.

**CAUTION:**

- Do not turn off the power or remove the USB cable until copying is complete.
- Files that are not on the index screen during playback cannot be copied.

**Playing Back Files**

Checks the created disc.

Operating Details

"Playing Back a BD/DVD Created on this Unit (GZ-HM350/GZ-HM330)" (P.48)

**Finalizing Discs After Copying**

Finalizes the disc after copying is finished. This enables the disc to be played back using this unit, on PC, BD/DVD writer or BD/DVD player that supports the BD-MV and AVCHD formats.

1 Select video or still image mode.

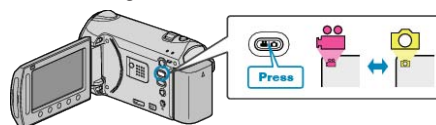

2 Select "FINALIZE" and touch **OK**.



3 Select "YES" and touch **OK**.

- After finalizing, touch **OK**.

**Changing Recording Media (video mode only)**

1 Select video mode.

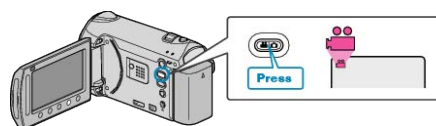

2 Select "CHANGE REC. MEDIA" and touch **OK**.



**How to Create DVDs Using an External Blu-ray Drive or DVDs with a Standard Image Quality**

To do so, you need to change the "CHANGE REC. MEDIA" setting in the "BACK-UP" menu.

- Selecting "Blu-ray DISC" enables you to save videos in a Blu-ray disc in the high-definition quality. (External Blu-ray drives only)
- Selecting "DVD(AVCHD)" enables you to save videos in a DVD in the high-definition quality.
- Selecting "DVD-Video" enables you to save videos in a DVD after converting to the standard image quality.

**Memo:**

- DVDs that are created with "DVD-Video" selected can be played back on normal DVD players.
- When backing up still images, "Blu-ray DISC" or "DVD" can be selected. Image quality of the still images will not be changed.

## Digest Playback

You can play back a few seconds from each scene of the recorded videos in the created DVD.

- 1 Load the created DVD on a DVD player.
  - 2 Select "DIGEST PLAYBACK" on the TV.
- The digest is played back continuously.

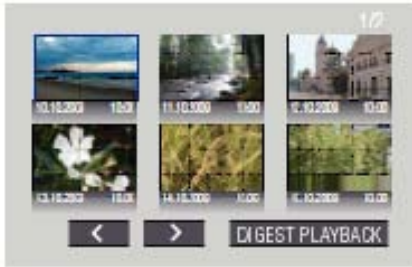

(The screen does not appear on this unit.)

### Memo:

- To normal playback/To index menu
  - 1) Press the top menu button on the remote control of the DVD device during digest playback.
  - 2) Select the desired item.
- "DIGEST PLAYBACK" menu is not available when the DVD is created using the provided Everio MediaBrowser software.

## Using a USB External Hard Disk Drive (GZ-HM350/GZHM330)

You can copy video and still image files to a USB external hard disk drive from this unit. You can also play the files in the USB external hard disk drive on this unit.

- Refer also to the instruction manual of the USB external hard disk drive.

### Recommended USB External Hard Disk Drives

Seagate	FreeAgent™ Desk series
LaCie	Design by Neil Poulton series

- When connecting to the above products, use a USB cable with Mini-A (Male) to Mini-B (Male) connectors.

"Optional Accessories" (P.20)

### Using a USB External Hard Disk Drive

"Preparing a USB External Hard Disk Drive" (P.85)

"Backing Up Files" (P.85)

"Playing Back Files in the USB External Hard Disk Drive" (P.86)

"Deleting Folders in the USB External Hard Disk Drive" (P.86)

"Formatting the USB External Hard Disk Drive" (P.86)

### Memo:

- USB external hard disk drives with the capacity over 2 TB cannot be used.
- Copying may take time. (For example, saving 1 hour video in XP mode takes about 20 minutes.)
- Sound or video may be interrupted during playback.
- Format the USB external hard disk drive when connecting it to this unit for the first time. (All data is deleted.)
- Refer to the help file of the provided Everio MediaBrowser software when you use the PC to operate the data in the USB external hard disk drive directly copied from this unit.

### CAUTION:

- Do not connect a USB hub between this unit and the USB external hard disk drive.
- Disconnect the USB external hard disk drive when using other USB devices such as a BD/DVD writer or another USB external hard disk drive.
- Avoid the following operations during copying and playing back.
  - Turning off the unit or the USB external hard disk drive.
  - Disconnecting the USB cable.
- Files deleted from this unit cannot be written to a disc using a BD/DVD writer even if they have been copied to the USB external hard disk drive.
- Do not format the USB external hard disk drive using the PC. If you did, format again using this unit. (All the data in the USB external hard disk drive will be erased.)
- Avoid the following operations using the PC.
  - Deleting files or folders in the USB external hard disk drive.
  - Moving files or folders in the USB external hard disk drive.
  - Changing the name of files or folders in the USB external hard disk drive.
 These operations make the data impossible to be played back on this unit.
- When you use the PC to edit the data in the USB external hard disk drive, copy the data to the PC before editing. Editing the data in the USB external hard disk drive directly from the PC makes the data impossible to be played back on this unit.

### Preparing a USB External Hard Disk Drive

- 1 Connect to a USB external hard disk drive.
- Turn off all units.

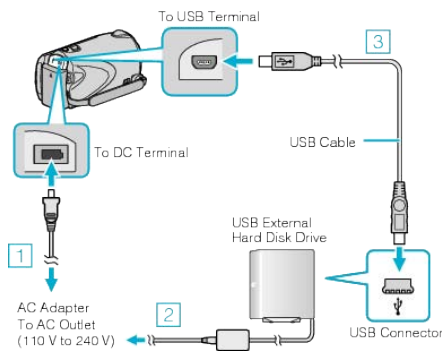

- ① Connect the AC adapter to this unit.
  - ② Connect the AC adapter of the USB external hard disk drive.
  - ③ Connect the USB cable provided with the USB external hard disk drive.
- The USB cable provided with this unit cannot be used.

- 2 Open the LCD monitor.

- After connecting, turn on this unit first, then turn on the USB external hard disk drive.

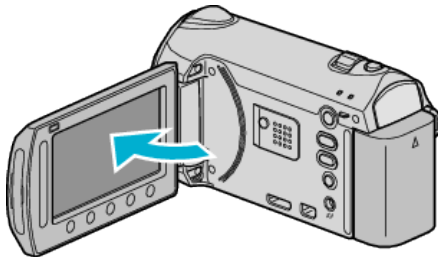

- The "VIDEO BACKUP"/"STILL IMAGE BACKUP" menu appears.
- While the USB cable is connected, the "VIDEO BACKUP"/"STILL IMAGE BACKUP" menu is displayed.

### Backing Up Files

- 1 Select video or still image mode.

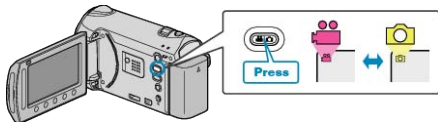

- 2 Select "BACK UP" and touch **OK**.



- 3 Select the media to back up and touch **OK**.



- 4 Select the desired menu and touch **OK**.



Setting	Details
<ul style="list-style-type: none"> <li>• "ALL SCENES"</li> <li>• "ALL IMAGES"</li> </ul>	All files in the recording medium are copied.
<ul style="list-style-type: none"> <li>• "UNSAVED SCENES"</li> <li>• "UNSAVED IMAGES"</li> </ul>	Files that have never been copied are automatically selected and copied.

- 5 Select "OK" and touch **OK**.



- After copying, touch **OK**.
- To cancel copying, select "STOP".

## Playing Back Files in the USB External Hard Disk Drive

1 Select video or still image mode.

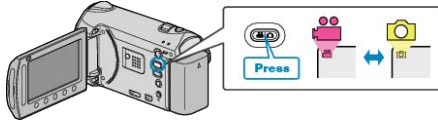

2 Select "PLAYBACK" and touch **OK**.



3 Select the desired folder and touch **OK**.



4 Select the desired file and touch **OK**.



• Touch **■** to stop playback.



• After deleting, touch **OK**.

## Formatting the USB External Hard Disk Drive

1 Select video or still image mode.

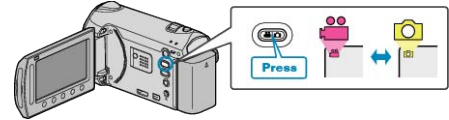

2 Select "FORMAT" and touch **OK**.



3 Select "YES" and touch **OK**.



• After formatting, touch **OK**.

## Deleting Folders in the USB External Hard Disk Drive

1 Select video or still image mode.

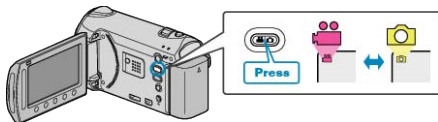

2 Select "DELETE" and touch **OK**.



3 Select the desired folder and touch **OK**.



4 Select "DELETE" and touch **OK**.



## Creating a Disc Using a Connected Blu-ray Recorder

You can create discs using a Blu-ray recorder by connecting it to this unit using a USB cable.

1 Close the LCD monitor and connect.

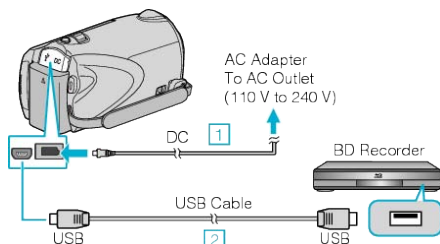

- ① Connect the AC adapter to this unit.
- ② Connect using the provided USB cable.

2 Open the LCD monitor.

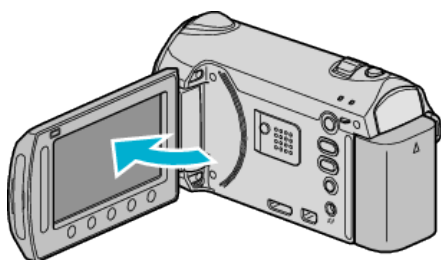

- The USB MENU appears.

3 Select "BACK UP" and touch .



4 Perform dubbing on the Blu-ray recorder.

- Refer also to the instruction manual of the Blu-ray recorder.



## Dubbing Files to a DVD Recorder or VCR

You can dub videos by connecting to a DVD recorder or VCR.

- Refer also to the instruction manuals of the TV, DVD recorder, VCR, etc.

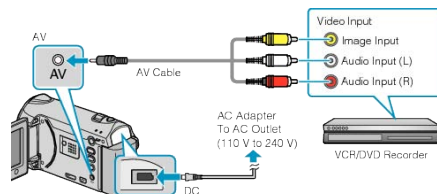
1 Connect to a VCR/DVD recorder.



- ① Press and hold the power  button for 2 seconds or more to turn off the power.
- ② Connect the AC adapter of this unit.
- ③ Connect using the provided AV cable.
- ④ Press and hold the power  button for 2 seconds or more to turn on the unit.

2 Select the playback mode.

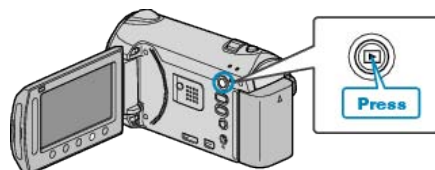

3 Prepare the TV/VCR for recording.

- Switch to a compatible external input.
- Insert a DVD-R or video tape.

4 Prepare this unit for playback.

- Set "VIDEO OUTPUT" in the connection settings menu to the aspect ratio (4:3 or 16:9) of the connecting TV.

"VIDEO OUTPUT" (  P.124 )

- To include the date during dubbing, set "DISPLAY ON TV" in the connection settings menu to "ON".  
Set "ON-SCREEN DISPLAY" in the playback menu to "DISPLAY DATE ONLY".

"DISPLAY ON TV" (  P.124 )

"ON-SCREEN DISPLAY" (  P.111 )

5 Start recording.

- Start playback on this unit and press the record button on the VCR/DVD recorder.

"Playing Back Videos" (  P.40 )

"Playing Back Playlists" (  P.48 )

- After playback is complete, stop the recording.

**Memo:** \_\_\_\_\_

- When there are many videos to dub, you can create a playlist in advance and play it back so that all your favorite videos can be dubbed at once.

"Creating Playlists with Selected Files" (  P.63 )

"Playing Back Playlists" (  P.48 )

## Copying to Windows PC

You can copy files to a PC using the provided software.  
 DVDs can also be created using the PC's DVD drive.  
 If the provided software is not installed, this unit will be recognized as an external storage when connected.

### GZ-HM300

**You can create only AVCHD discs using the provided application software.**

To create DVD-Video discs, refer to "Dubbing Files to a DVD Recorder or VCR" (P.87) .  
 Using the optional application software, you can create DVD-Video and BD discs on a computer.  
 Download the optional software here  
[http://www.pixela.co.jp/oem/jvc/mediabrowser/e/purchase\\_dl/mediabrowser\\_hd\\_2/](http://www.pixela.co.jp/oem/jvc/mediabrowser/e/purchase_dl/mediabrowser_hd_2/)

### Memo:

- To record to discs, a recordable DVD drive is required for the PC in use.
- Still images cannot be recorded to discs using the provided software.

### Trouble with Using the Provided Software Everio MediaBrowser

Consult the customer service center below.

- Pixela User Support Center

<b>Telephone</b>	USA and Canada (English): +1-800-458-4029 (toll-free) Europe (UK, Germany, France, and Spain) (English/German/French/Spanish): +800-1532-4865 (toll-free) Other Countries in Europe (English/German/French/Spanish): +44-1489-564-764 Asia (Philippines) (English): +63-2-438-0090 China (Chinese): 10800-163-0014 (toll-free)
<b>Homepage</b>	<a href="http://www.pixela.co.jp/oem/jvc/mediabrowser/e/">http://www.pixela.co.jp/oem/jvc/mediabrowser/e/</a>

- For details on how to upload to Youtube™, refer to "MediaBrowser Help" in the "Help" menu of Everio MediaBrowser.

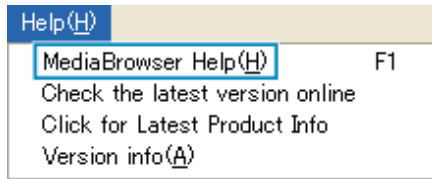

### Verifying System Requirements (Guideline)

Right-click on "Computer" (or "My Computer") in the "Start" menu and select "Properties" to check the following items.

### Windows Vista / Windows 7

- Refer to the operating instructions found in the animation on the Detailed User Guide.

### Windows XP

- Refer to the operating instructions found in the animation on the Detailed User Guide.

	Windows Vista / Windows 7	Windows XP
OS	Windows Vista 32/64-bit Home Basic or Home Premium (Pre-installed versions only) Service Pack 2 Windows 7 32/64-bit Home Premium (Pre-installed versions only)	Windows XP Home Edition or Professional (Pre-installed versions only) Service Pack 3
CPU	Intel Core Duo CPU 1.66 GHz or higher Intel Core 2 Duo CPU 2.13 GHz or higher recommended	Intel Core Duo CPU 1.66 GHz or higher Intel Core 2 Duo CPU 2.13 GHz or higher recommended
RAM	At least 2 GB	At least 1 GB

### Memo:

- If your PC does not meet the above system requirements, operations of the provided software cannot be guaranteed.  
 "Backing Up Files Without Using Provided Software" (P.93)
- For more information, contact your PC's manufacturer.

### Installing the Provided Software

You can display the recorded images in calendar format and perform simple editing using the provided software.

### Windows Vista / Windows 7

- Refer to the operating instructions found in the animation on the Detailed User Guide.

### Windows XP

- Refer to the operating instructions found in the animation on the Detailed User Guide.

### Backing Up All Files

Before making backup, make sure that enough free space is left in the PC's hard disk (HDD).

1 Connect the USB cable and AC adapter.

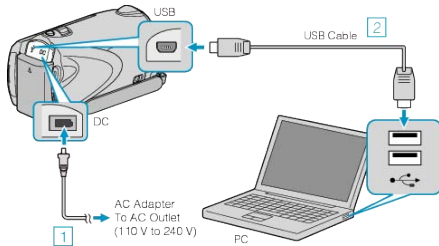

- ① Connect the AC adapter to this unit.
- ② Connect using the provided USB cable.

2 Open the LCD monitor.

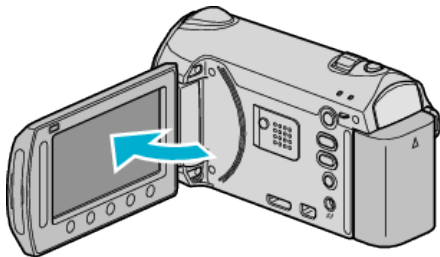

- The USB MENU appears.

3 Select "BACK UP" and touch **OK**.



- The provided software Everio MediaBrowser starts up on the PC. The subsequent operations are to be performed on the PC.

4 Select the volume.

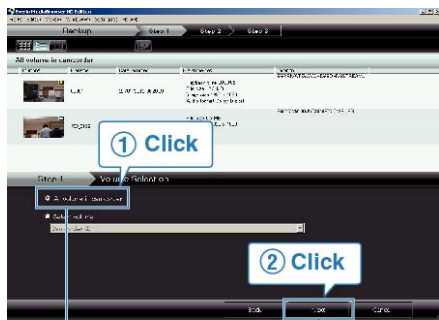

Click "All volume in camcorder"

5 Start backup.

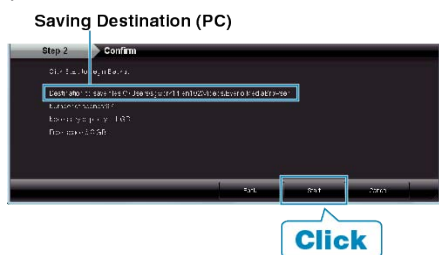

Click

- Backup starts.

6 After backup is complete, click "OK".



#### Memo:

- Before making backup, load the SD card in which the videos and still images are stored on this unit.
- If you encounter any problems with the provided software Everio MediaBrowser, please consult the "Pixela User Support Center".
- "Trouble with Using the Provided Software Everio MediaBrowser" (P.88)
- Delete unwanted videos before making backup. It takes time to back up many videos.
- "Deleting Unwanted Files" (P.49)

### Disconnecting this Unit from PC

1 Click "Safely Remove Hardware".

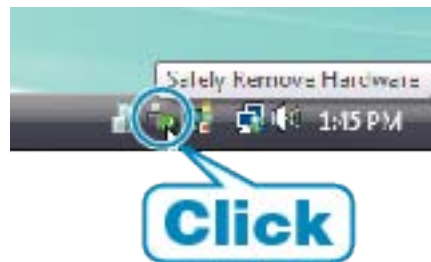

2 Click "Safely Remove USB Mass Storage Device".

3 (For Windows Vista) Click "OK".

4 Disconnect the USB cable and close the LCD monitor.

## Organizing Files

After backing up your files, organize them by adding labels such as "Family Trip" or "Athletic Meet". This is useful not only for creating discs, but for viewing the files too.

- 1 Double-click on the Everio MediaBrowser icon.
- The provided software starts up.



- 2 Display the month of the files to organize.



- 3 Create a user list.

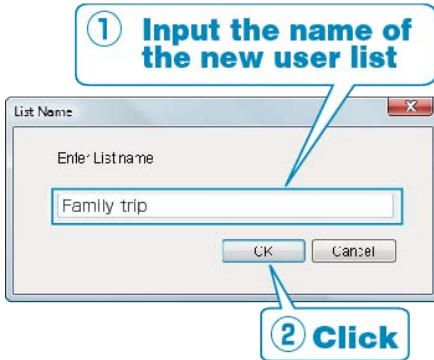
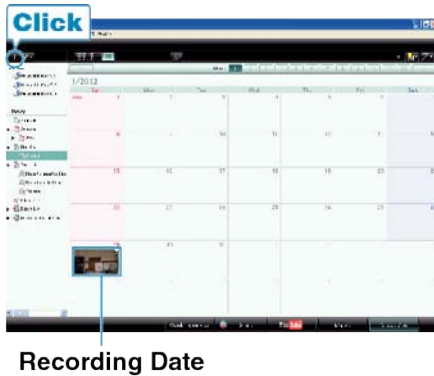

- A new user list is added to the user list library.
- 4 Click on the recording day.
  - The thumbnails of the files recorded on the day are displayed.
- 5 Register files to the created user list.

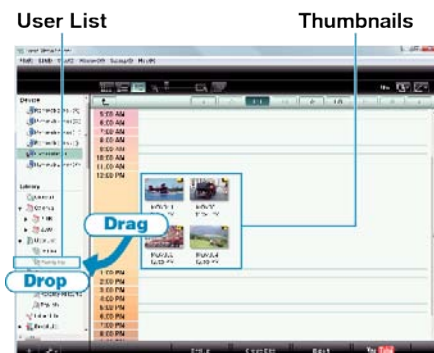

Identifying Video or Still Image : \_\_\_\_\_

- You can select files using the "SELECT" menu on the top right of the screen.
- Check the video/still image icon on the top right corner of the thumbnail.



Memo: \_\_\_\_\_

- If you encounter any problems with the provided software Everio MediaBrowser, please consult the "Pixela User Support Center".
- "Trouble with Using the Provided Software Everio MediaBrowser" (P.88)



## Recording Videos to Discs

Copy the files that are arranged using the user list to DVDs.



- After copying, click “OK”.

### GZ-HM300

**You can create only AVCHD discs using the provided application software.**

To create DVD-Video discs, refer to "Dubbing Files to a DVD Recorder or VCR" (P.87) .

Using the optional application software, you can create DVD-Video and BD discs on a computer.

Download the optional software here

[http://www.pixela.co.jp/oem/jvc/mediabrowser/e/purchase\\_dl/mediabrowser\\_hd\\_2/](http://www.pixela.co.jp/oem/jvc/mediabrowser/e/purchase_dl/mediabrowser_hd_2/)

1 Insert a new disc into the PC's recordable DVD drive.

2 Select the desired user list.

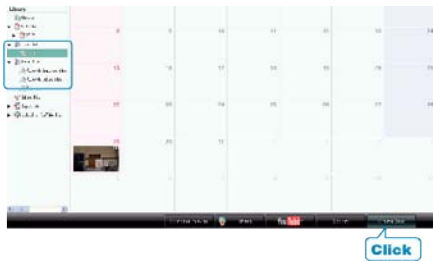

3 Select the disc type (GZ-HM350/GZ-HM330 only).



4 Select the method of file selection.



- If you select “Select all files displayed”, only the displayed videos are copied to the disc. Proceed to step 6.
- If you select “Select files individually”, proceed to step 5.

5 (When “Select files individually” is selected) Select the files to copy to disc in order.



6 Set the top menu of the disc.



- Set the title and menu background.

7 Copying to disc starts.

### Memo:

- The following types of discs can be used on the provided software Everio MediaBrowser.
  - DVD-R
  - DVD-R DL
  - DVD-RW
  - DVD+R
  - DVD+R DL
  - DVD+RW
  - BD (GZ-HM350/GZ-HM330 only)
- Everio MediaBrowser supports 3 disc formats:
  - AVCHD
  - DVD-Video (GZ-HM350/GZ-HM330 only)
  - BD (GZ-HM350/GZ-HM330 only)
- When copying videos recorded in UXP recording mode to create an AVCHD disc, the videos need to be converted to XP recording mode before copying. Therefore, it may take a longer time than copying videos recorded in other modes.
- Use Everio MediaBrowser Player to play back the disc. Refer to the help file of the provided Everio MediaBrowser software to operate.
- To view the help file of Everio MediaBrowser, select "Help" from the Everio MediaBrowser's menu bar or press F1 on the keyboard.

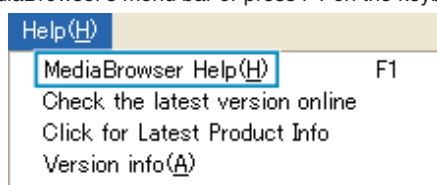

- If you encounter any problems with the provided software Everio MediaBrowser, please consult the "Pixela User Support Center".

"Trouble with Using the Provided Software Everio MediaBrowser" (P.88)

## JVC Software Licence Agreement

### IMPORTANT

TO CUSTOMERS: PLEASE MAKE SURE TO READ THIS CAREFULLY BEFORE INSTALLING OR USING THE SOFTWARE PROGRAM NAMED "DIGITAL PHOTO NAVIGATOR" ("Program") ON YOUR PC. The right to use the Program is granted by Victor Company of Japan, Limited ("JVC") to You only on the condition that You agree to the following.

Should You not agree to the terms hereof, You may not install or use the Program. HOWEVER, INSTALLING OR USING THE PROGRAM INDICATES YOUR ACCEPTANCE OF THESE TERMS AND CONDITIONS.

#### 1 COPYRIGHT; OWNERSHIP

You acknowledge that all copyrights and other intellectual property rights in the Program are owned by JVC and its licensor, and remain vested in JVC and such licensor. The Program is protected under the copyright law of Japan and other countries, and related Conventions.

#### 2 GRANT OF LICENCE

- ① Subject to the conditions of this Agreement, JVC grants to You a non-exclusive right to use the Program. You may install and use the Program on a HDD or other storage devices incorporated in Your PC.
- ② You may make one (1) copy of the Program solely for your personal backup or archival purposes.

#### 3 RESTRICTION ON THE PROGRAM

- ① You may not reverse engineer, decompile, disassemble, revise or modify the Program, except to the extent that expressly permitted by applicable law.
- ② You may not copy or use the Program, in whole or in part, other than as expressly specified in this Agreement.
- ③ You have no right to grant a licence to use the Program, and may not distribute, rent, lease or transfer the Program to any third party or otherwise let them use the Program.

#### 4 LIMITED WARRANTY

JVC warrants that any media in which the Program is embodied are free from any defects in materials and workmanship for a period of thirty (30) days from the date of Your purchasing any our products accompanying the Program. JVC's entire liability and your exclusive remedy in connection with the Program shall be replacement of such defective media. EXCEPT FOR THE EXPRESS WARRANTIES STATED HEREIN AND TO THE EXTENT PERMITTED BY APPLICABLE LAW, JVC AND ITS LICENSORS DISCLAIM ANY OTHER WARRANTIES, EITHER EXPRESS OR IMPLIED, INCLUDING BUT NOT LIMITED TO IMPLIED WARRANTIES OF MERCHANTABILITY AND FITNESS FOR A PARTICULAR PURPOSE IN REGARD TO THE PROGRAM AND THE ACCOMPANYING PRINTED MATERIALS. SHOULD THERE BE ANY PROBLEM ARISING FROM OR CAUSED BY THE PROGRAM, YOU SHOULD SETTLE ALL SUCH PROBLEM AT YOUR OWN COST AND EXPENSE.

#### 5 LIMITED LIABILITY

TO THE EXTENT PERMITTED BY APPLICABLE LAW, IN NO EVENT SHALL JVC AND ITS LICENSORS BE LIABLE FOR ANY INDIRECT, SPECIAL, INCIDENTAL OR CONSEQUENTIAL DAMAGES WHATSOEVER, REGARDLESS OF THE FORM OF ACTION WHETHER IN CONTRACT, TORT OR OTHERWISE ARISING OUT OF OR IN CONNECTION WITH THE USE OF OR INABILITY TO USE THE PROGRAM, EVEN IF JVC HAS BEEN ADVISED OF THE POSSIBILITY OF SUCH DAMAGES. YOU WILL INDEMNIFY AND HOLD HARMLESS JVC FROM ANY LOSS, LIABILITY OR COST ARISING OUT OF OR IN ANY WAY CONNECTED TO CLAIMS FROM ANY THIRD PARTY RELATING TO THE USE OF THE PROGRAM.

#### 6 TERM

This Agreement will become effective on the date when You install and use the Program on Your machine, and continue to be in effect until the termination under the following provision.

Should You breach any provision of this Agreement, JVC may terminate this Agreement without giving any notice to You. In this event, JVC may claim against You for any damages caused by Your breach. Should this Agreement be terminated, You must immediately destroy the Program stored in Your machine (including the erasing from any memory in Your PC), and no longer own such Program.

**7 EXPORT CONTROL**

You agree that You will not ship, transfer or export the Program or underlying information and technology to any countries to which Japan and other relevant countries have initiated an embargo on such goods.

**8 U.S. GOVERNMENT USER**

If You are an agency of the United States of America (the "Government"), You acknowledge JVC's representation that the Program is a "Commercial Item" as defined in Federal Acquisition Regulation (FAR) part 2.101 (g) consisting unpublished "Commercial Computer Software" as those items are used at FAR part 12.212 and is only licenced to You with the same use rights JVC grants all commercial end users pursuant to the terms of this Agreement.

**9 GENERAL**

- ① No modification, change, addition, deletion or other alternation of or to this Agreement will be valid unless reduced to writing and signed by an authorized representative of JVC.
- ② If any part of this Agreement is held invalid by or in conflict with any law having jurisdiction over this Agreement, the remaining provisions will remain in full force and effect.
- ③ This Agreement shall be governed by and interpreted under the laws of Japan. The Tokyo District Court has jurisdiction over all disputes which may arise with respect to the execution, interpretation and performance of this Agreement.

Victor Company of Japan, Limited

**Memo:** \_\_\_\_\_

- If You acquired the Program in Germany, the provisions of Sections 4 (Limited Warranty) and 5 (Limited Liability) provided above will be replaced with those of the German version of this Agreement.

**CAUTION:** \_\_\_\_\_

- Operate this equipment according to the operating procedures described in this manual.
- Use only the provided CD-ROM. Never use any other CD-ROM to run this software.
- Do not attempt to modify this software.
- Changes or modifications not approved by JVC could void user's authority to operate the equipment.

**How to handle a CD-ROM :** \_\_\_\_\_

- Take care not to soil or scratch the mirror surface (opposite to the printed surface). Do not write anything or put a sticker on either the front or back surface. If the CD-ROM gets dirty, gently wipe it with a soft cloth outward from the center hole.
- Do not use conventional disc cleaners or cleaning spray.
- Do not bend the CD-ROM or touch its mirror surface.
- Do not store your CD-ROM in a dusty, hot or humid environment. Keep it away from direct sunlight.

You can find the latest information (in English) on the provided software program at our world wide web server at <http://www.jvc-victor.co.jp/english/global-e.html>

**Backing Up Files Without Using Provided Software**

Copy the files to a PC using the following method.

- 1 Connect the USB cable and AC adapter.

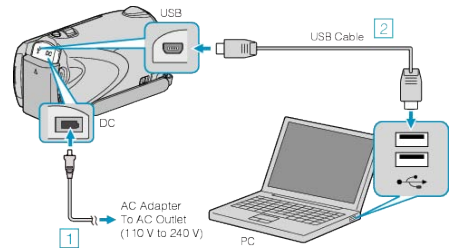

- ① Connect the AC adapter to this unit.
- ② Connect using the provided USB cable.

- 2 Open the LCD monitor.

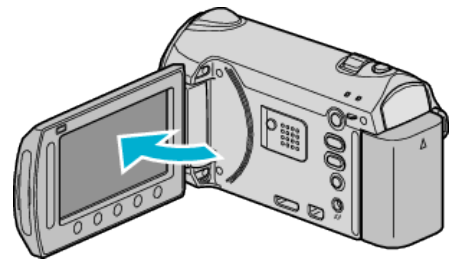

- The USB MENU appears.

- 3 Select "PLAYBACK ON PC" and touch **OK**.



- Close the Everio MediaBrowser program, if it starts.
- The subsequent operations are to be performed on the PC.

- 4 Select "Computer" (Windows Vista) / "My Computer" (Windows XP) from the start menu, then click on the EVERIO\_MEM or EVERIO\_SD icon.

- The folder opens.

- 5 Copy the files to any folder in the PC (desktop, etc).

**CAUTION:** \_\_\_\_\_

- When the folders or files are deleted/moved/renamed in the computer, they cannot be played back on this unit anymore.

**Memo:** \_\_\_\_\_

- To edit the files, use a software that supports MTS/JPEG files.
- The above operations on PC may vary with the system used.

**Disconnecting this Unit from PC**

- 1 Click "Safely Remove Hardware".

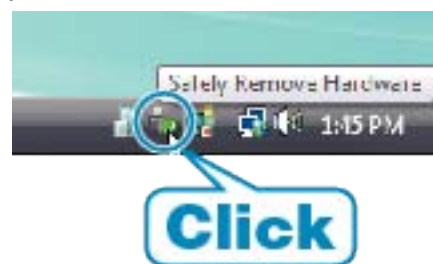

- 2 Click "Safely Remove USB Mass Storage Device".

- 3 (For Windows Vista) Click "OK".

- 4 Disconnect the USB cable and close the LCD monitor.

List of Files and Folders

Folders and files are created in the built-in memory and SD card as shown below.

They are created only when necessary.

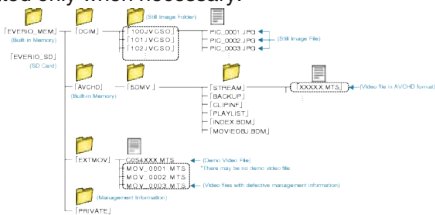

CAUTION:

- When the folders or files are deleted/moved/rename in the computer, they cannot be played back on this unit anymore.

Copying to Mac Computer

Copy the files to a Mac computer using the following method.

1 Connect the USB cable and the AC adapter.

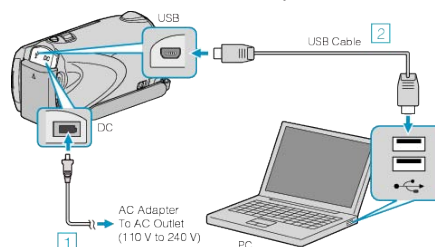

- 1 Connect the AC adapter to this unit.
- 2 Connect using the provided USB cable.
  - The provided software is not required for this process.

2 Open the LCD monitor.

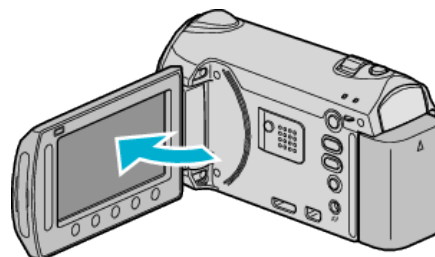

- The USB MENU appears.

3 Select "PLAYBACK ON PC" and touch  $\odot$ .



- The subsequent operations are to be performed on the PC.

4 Click on the "EVERIO\_MEM" or "EVERIO\_SD" icon on the desktop.

- The folder opens.

5 Click on the column display icon.

Column Display Icon

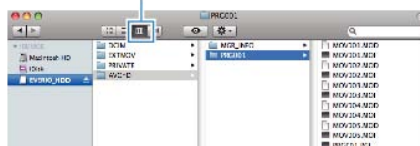

- Search the folder with the desired files.

6 Copy the files to any folder in the PC (desktop, etc).

Files to Copy



CAUTION:

- When the folders or files are deleted/moved/rename in the computer, they cannot be played back on this unit anymore.
- Movie files that are copied to a Mac computer cannot be imported to iMovie. Import the files to iMovie directly from this unit.

Memo:

- To edit the files, use a software that supports MTS/JPEG files.
- When removing this unit from the computer, drag and drop the "EVERIO\_MEM" or "EVERIO\_SD" icon on the desktop to the trash bin.



---

### **iMovie and iPhoto**

You can import files from this unit to a computer using Apple's iMovie'08, '09 (video) or iPhoto (still image).

To verify the system requirements, select "About This Mac" from the Apple menu. You can determine the operating system version, processor and amount of memory.

- For the latest information on iMovie or iPhoto, refer to the Apple website.
- For details on how to use iMovie or iPhoto, refer to the help file of the respective software.
- There is no guarantee that the operations will work with all computer environments.

## Operating the Menu

Use the slider and operation buttons to set the menu.

- The menu differs according to the mode in use.

1 Touch **MENU** to display the menu.

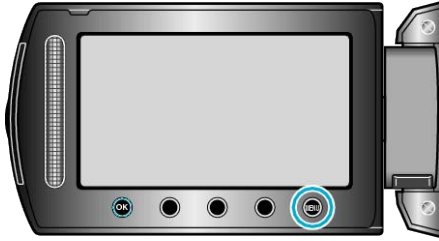

2 Select the desired menu and touch **OK**.



3 Select the desired setting and touch **OK**.



### Memo:

- To close the menu, touch **MENU**.
- To return to the previous screen, touch **RETURN**.

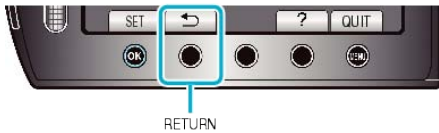

- To display the help file, touch **?**.



### Returning All Settings to Default :

- Set using "FACTORY PRESET" in the basic settings menu.
- "FACTORY PRESET" (P.123)

## Recording Menu (Video)

You can adjust various settings, such as brightness and white balance, to suit the subject or purpose. You can also change settings such as picture quality and gain.

Setting	Details
MANUAL SETTING	Recording settings can be adjusted manually. <ul style="list-style-type: none"> <li>They are displayed only when recording in the manual mode.</li> </ul> "Manual Settings Menu" ( P.107)
FACE PRIORITY AE/AF	Detects faces and adjusts the brightness and focus automatically. "FACE PRIORITY AE/AF" ( P.98)
LIGHT	Turns on/off the light. "LIGHT (GZ-HM350/GZ-HM330)" ( P.98)
REGISTER EVENT	Categorizes your videos according to events (such as "Travel", "Athletic Event") by registering the file before recording. "Registering Files to Events Before Recording" ( P.32)
VIDEO QUALITY	Sets the video quality. "VIDEO QUALITY" ( P.99)
ZOOM	Sets the maximum zoom ratio. "ZOOM" ( P.99)
GAIN UP	Makes the subject appear bright automatically when recording in dark places. "GAIN UP" ( P.100)
TIME-LAPSE RECORDING	Enables the changes of a scene that occur slowly over a long period to be shown within a short time by taking frames of it at a certain interval. "Recording at Intervals (TIME-LAPSE RECORDING)" ( P.35)
AUTO REC	Enables the unit to start or stop recording automatically by sensing the changes in brightness within the red frame displayed on the LCD monitor. "Recording Automatically by Sensing Movements (AUTO REC)" ( P.36)
SEAMLESS RECORDING	Automatically switches to a different media and continues recording when the remaining space on the current recording media runs out. For example, when the remaining space on the SD card runs out during recording, the recording continues on the built-in memory without stopping. "SEAMLESS RECORDING" ( P.101)
x.v.Color	Records with "x.v.Color". "x.v.Color" ( P.101)
WIND CUT	Reduces the noise caused by wind. "WIND CUT" ( P.102)

## FACE PRIORITY AE/AF

Detects faces and adjusts the brightness and focus automatically.

Setting	Details
OFF	Deactivates the function.
ON	Activates the function.

### Displaying the Item

1 Select video mode.



2 Touch to display the menu.

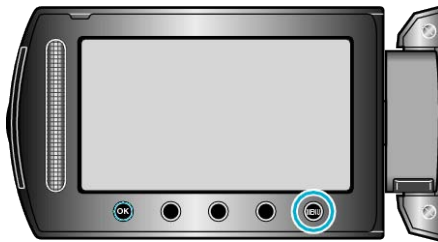

3 Select "FACE PRIORITY AE/AF" and touch .



### CAUTION:

- When "FACE PRIORITY AE/AF" is set to "ON", the following settings will change.
  - If "SCENE SELECT" is set to "SPOTLIGHT", it will be switched to "OFF".
  - If "FOCUS" is set to "MANUAL", it will be switched to "AUTO".
  - If "FOCUS ASSIST" is set, "FOCUS" will be switched to "AUTO".
  - If "BACKLIGHT COMP." is set to "ON", it will be switched to "OFF".
  - If "METERING AREA/ TYPE" is set to "SPOT", it will be switched to "ENTIRE SCREEN".
- When the following settings are made, "FACE PRIORITY AE/AF" will switch to "OFF".
  - When "SCENE SELECT" is set to "SPOTLIGHT"
  - When "FOCUS" is set to "MANUAL"
  - When "FOCUS ASSIST" is selected
  - When "BACKLIGHT COMP." is set to "ON"
  - When "METERING AREA/ TYPE" is set to "SPOT"

### Memo:

- Depending on the condition, faces may not be detected.

## LIGHT (GZ-HM350/GZ-HM330)

Turns on/off the light.

Setting	Details
OFF	Does not light up.
AUTO	Lights up automatically when the surrounding is dark.
ON	Lights up at all times.

### Displaying the Item

1 Select video mode.

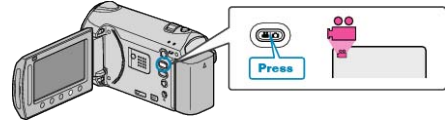

2 Touch to display the menu.

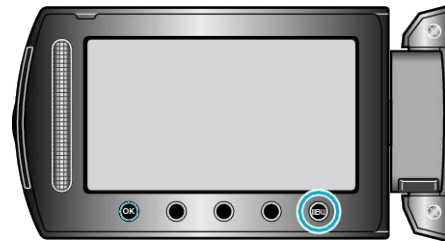

3 Select "LIGHT" and touch .



### REGISTER EVENT

Categorizes your videos according to events (such as "Travel", "Athletic Event") by registering the file before recording.

Operating Details

"Registering Files to Events Before Recording" (P.32)

### VIDEO QUALITY

Sets the video quality.

Setting	Details
UXP	Enables recording in the best picture quality. <ul style="list-style-type: none"> <li>Applies to BDs only. To save to DVDs, it is necessary to re-encode the videos to XP mode using the provided software.</li> </ul>
XP	Enables recording in high picture quality.
SP	Enables recording in standard quality.
EP	Enables long recordings.

**Memo:**

- Set to "UXP" or "XP" mode when recording fast-moving scenes or scenes with extreme change of brightness to avoid noise.
- Use a BD writer to save videos recorded in UXP mode.

#### Displaying the Item

1 Select video mode.

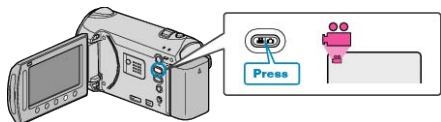

2 Touch to display the menu.

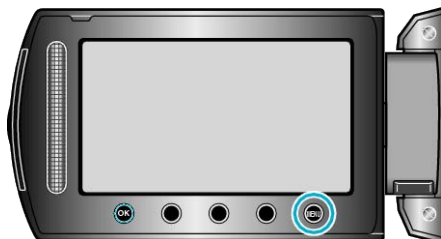

3 Select "VIDEO QUALITY" and touch .



### ZOOM

Sets the maximum zoom ratio.

Setting	Details
20x/OPTICAL (GZ-HM300)	Enables zooming up to 20x.
30x/OPTICAL (GZ-HM350/GZ-HM330)	Enables zooming up to 30x.
60x/DIGITAL (GZ-HM350/GZ-HM330)	Enables zooming up to 60x.
80x/DIGITAL (GZ-HM300)	Enables zooming up to 80x.
200x/DIGITAL	Enables zooming up to 200x.

**Memo:**

- When digital zoom is used, the image becomes grainy as it is digitally enlarged.

#### Displaying the Item

1 Select video mode.

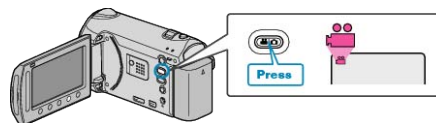

2 Touch to display the menu.

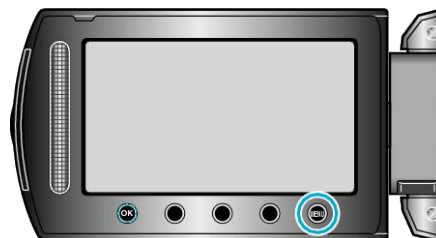

3 Select "ZOOM" and touch .





## GAIN UP

Makes the subject appear bright automatically when recording in dark places.

Setting	Details
OFF	Deactivates the function.
AGC	Electrically brightens the scene when it is dark.
AUTO	Automatically brightens the scene when it is dark.

### Memo:

- Although "AUTO" brightens the scene more than "AGC", movements of the subject may become unnatural.
- Setting can be adjusted separately for still images.

## Displaying the Item

1 Select video mode.

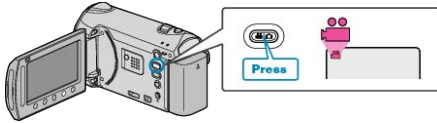

2 Touch to display the menu.

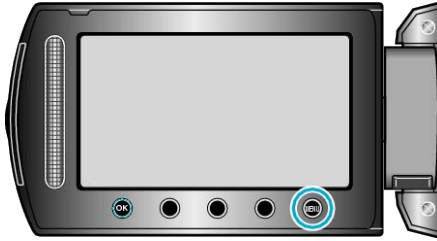

3 Select "GAIN UP" and touch .



## TIME-LAPSE RECORDING

This function enables the changes of a scene that occur slowly over a long period to be shown within a short time by taking frames of it at a certain interval.

This is useful for making observations such as the opening of a flower bud.

Operating Details

"Recording at Intervals (TIME-LAPSE RECORDING)" (P.35)

## AUTO REC

Records automatically by sensing the changes in brightness.

Operating Details

"Recording Automatically by Sensing Movements (AUTO REC)" (P.36)

### SEAMLESS RECORDING

This function enables an ongoing video recording that has reached its media's maximum capacity to be recorded continuously without frame loss by automatically switching the recording to another media. It is also possible for the scenes to be merged into one of the media once the recording is complete.

Setting	Details
OFF	Does not switch recording media automatically.
ON	Switches recording media automatically.

#### Displaying the Item

1 Select video mode.

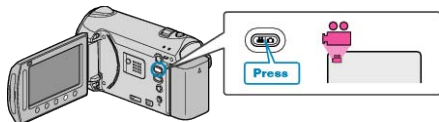

2 Touch **OK** to display the menu.



3 Select "SEAMLESS RECORDING" and touch **OK**.



4 Select "ON" and touch **OK**.



### x.v.Color

Records with "x.v.Color".

Setting	Details
OFF	Deactivates the function.
ON	Activates the function.

#### Displaying the Item

1 Select video mode.

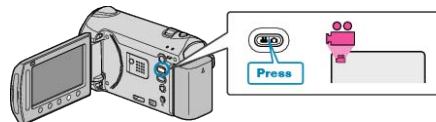

2 Touch **OK** to display the menu.

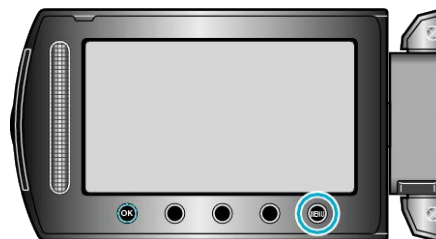

3 Select "x.v.Color" and touch **OK**.



#### Warning

- Auto switching of media cannot be performed when a write protected memory card, an unformatted media, or an incompatible media is used.
- The function does not work when there is less than 1 minute of recording time left in the other media.
- Recording cannot be performed when the seamless recording disabled icon [SEAMLESS\_NO] is displayed.

#### Memo:

- Seamless recording allows the unit to automatically switch to another media if the targeted media for recording is unavailable or has less than 1 second of recording time left.
- Once a seamless recording is complete, the function is automatically disabled. Combine the recorded scenes or delete the scene combination information to reactivate it.
- Seamless videos that are recorded on two separate media can be combined into a single video.

"Combining Videos Recorded by Seamless Recording" (P.70)

### WIND CUT

Reduces the noise caused by wind.

Setting	Details
OFF	Deactivates the function.
ON	Activates the function.

### Displaying the Item

- 1 Select video mode.

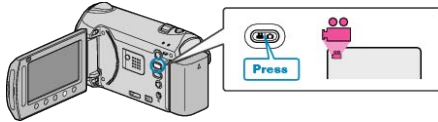

- 2 Touch  to display the menu.

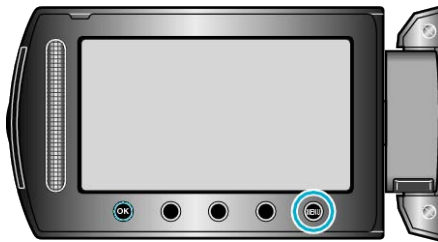

- 3 Select "WIND CUT" and touch .



## Recording Menu (Still Image)

You can adjust various settings, such as brightness and white balance, to suit the subject or purpose. You can also change settings such as picture quality and gain.

Setting	Details
MANUAL SETTING	Recording settings can be adjusted manually. • They are displayed only when recording in the manual mode. "Manual Settings Menu" (P.107)
FACE PRIORITY AE/AF	Detects faces and adjusts the brightness and focus automatically. "FACE PRIORITY AE/AF" (P.103)
LIGHT	Turns on/off the light. "LIGHT (GZ-HM350/GZ-HM330)" (P.104)
SELF-TIMER	Use this when taking a group photo. "SELF-TIMER" (P.104)
SHUTTER MODE	Continuous shooting settings can be adjusted. "SHUTTER MODE" (P.105)
IMAGE SIZE	Sets the image size (number of pixels) for still images. "IMAGE SIZE" (P.105)
IMAGE QUALITY	Sets the image quality. "IMAGE QUALITY" (P.106)
GAIN UP	Makes the subject appear bright automatically when recording in dark places. "GAIN UP" (P.106)
AUTO REC	Enables the unit to record still images automatically by sensing the changes in brightness within the red frame displayed on the LCD monitor. "Recording Automatically by Sensing Movements (AUTO REC)" (P.36)

### FACE PRIORITY AE/AF

Detects faces and adjusts the brightness and focus automatically.

Setting	Details
OFF	Deactivates the function.
ON	Activates the function.

### Displaying the Item

1 Select still image mode.

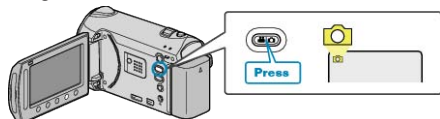

2 Touch **OK** to display the menu.



3 Select "FACE PRIORITY AE/AF" and touch **OK**.



### CAUTION:

- When "FACE PRIORITY AE/AF" is set to "ON", the following settings will change.

- If "SCENE SELECT" is set to "SPOTLIGHT", it will be switched to "OFF".
- If "FOCUS" is set to "MANUAL", it will be switched to "AUTO".
- If "FOCUS ASSIST" is set, "FOCUS" will be switched to "AUTO".
- If "BACKLIGHT COMP." is set to "ON", it will be switched to "OFF".
- If "METERING AREA/ TYPE" is set to "SPOT", it will be switched to "ENTIRE SCREEN".
- When the following settings are made, "FACE PRIORITY AE/AF" will switch to "OFF".
  - When "SCENE SELECT" is set to "SPOTLIGHT"
  - When "FOCUS" is set to "MANUAL"
  - When "FOCUS ASSIST" is selected
  - When "BACKLIGHT COMP." is set to "ON"
  - When "METERING AREA/ TYPE" is set to "SPOT"

### Memo:

- You cannot activate "FACE PRIORITY AE/AF" if "SELF-TIMER" is set to "FACE DETECTION".
- Depending on the condition, faces may not be detected.

## LIGHT (GZ-HM350/GZ-HM330)

Turns on/off the light.

Setting	Details
OFF	Does not light up.
AUTO	Lights up automatically when the surrounding is dark.
ON	Lights up at all times.

### Displaying the Item

1 Select still image mode.

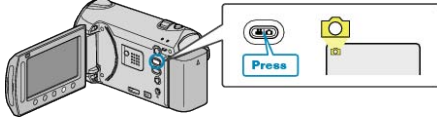

2 Touch **MEM** to display the menu.

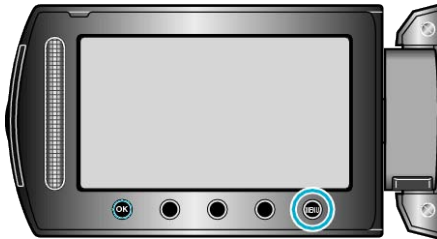



3 Select "LIGHT" and touch **OK**.



## SELF-TIMER

Use this when taking a group photo.

Setting	Details
OFF	Deactivates the self-timer.
2SEC	Starts recording 2 seconds after the SNAPSHOT button is pressed.
10SEC	Starts recording 10 seconds after the SNAPSHOT button is pressed. This setting is suitable for taking group photos.
FACE-DETECTION	<p>Detects faces when the SNAPSHOT button is pressed. Recording starts 3 seconds after the face of the photographer is detected.</p> <p>(1) Faces are detected</p>  <p>(2) Face of photographer is detected</p> 

### Displaying the Item

1 Select still image mode.

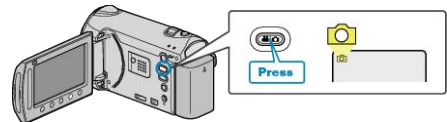

2 Touch **MEM** to display the menu.

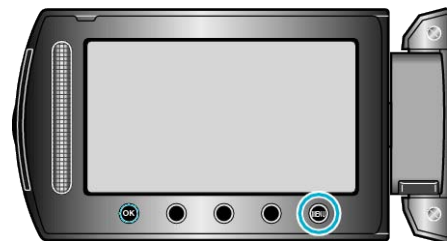

3 Select "SELF-TIMER" and touch **OK**.





### SHUTTER MODE

Continuous shooting settings can be adjusted.

Setting	Details
RECORD ONE SHOT	Records one still image.
CONTINUOUS SHOOTING	Records still images continuously while the SNAPSHOT button is pressed.

**Memo:**

- Up to 3 images can be captured in 1 second during continuous shooting.
- Some SD cards may not support continuous shooting.
- The continuous shooting speed will drop if this function is used repeatedly.

### Displaying the Item

1 Select still image mode.

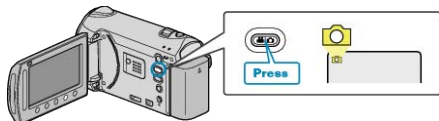

2 Touch **Ⓜ** to display the menu.

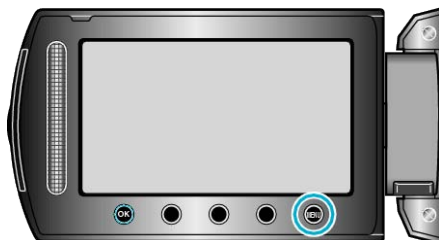

3 Select "SHUTTER MODE" and touch **Ⓚ**.



### IMAGE SIZE

Sets the image size (number of pixels) for still images.

Setting	Details
1920X1080(2M)	Takes still images in the size of 1920X1080 with aspect ratio 16:9.
1440X1080(1.5M)	Takes still images in the size of 1440X1080 with aspect ratio 4:3.
640X480(0.3M)	Takes still images in the size of 640X480 with aspect ratio 4:3.

### Displaying the Item

1 Select still image mode.

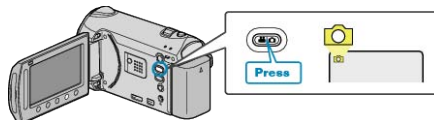

2 Touch **Ⓜ** to display the menu.

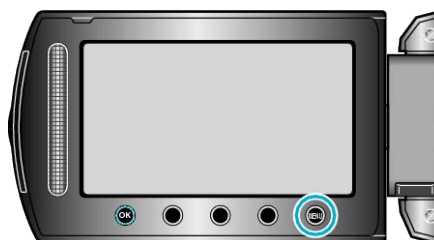

3 Select "IMAGE SIZE" and touch **Ⓚ**.



## IMAGE QUALITY

Sets the image quality.

Setting	Details
FINE	Enables recording in high picture quality, but number of recordable images becomes lesser.
STANDARD	Enables recording in standard quality.

### Displaying the Item

- 1 Select still image mode.

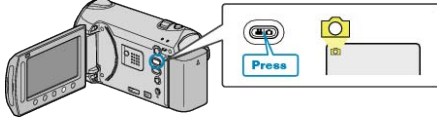

- 2 Touch to display the menu.

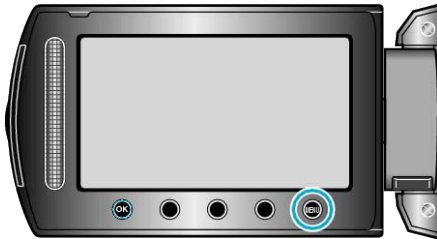

- 3 Select "IMAGE QUALITY" and touch .



## GAIN UP

Makes the subject appear bright automatically when recording in dark places.

Setting	Details
OFF	Deactivates the function.
AGC	Electrically brightens the scene when it is dark.

### Memo:

- Setting can be adjusted separately for videos.

### Displaying the Item

- 1 Select still image mode.

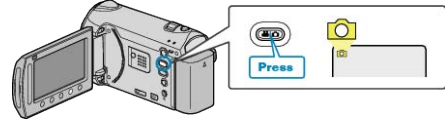

- 2 Touch to display the menu.

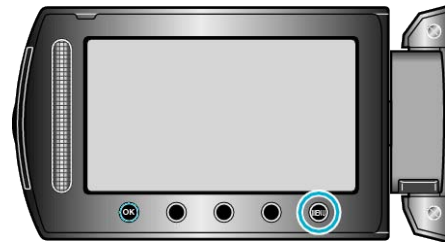

- 3 Select "GAIN UP" and touch .

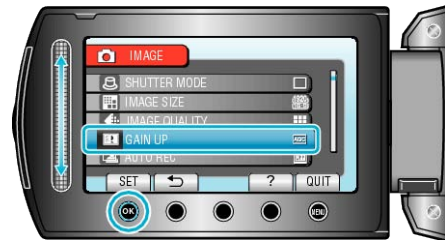

## AUTO REC

Records automatically by sensing the changes in brightness.

Operating Details

"Recording Automatically by Sensing Movements (AUTO REC)" (P.36)

## Manual Settings Menu

Recording settings can be adjusted manually.

### Memo:

- They are displayed only when recording in the manual mode.

Setting	Details
SCENE SELECT	Settings to suit the shooting condition can be selected. "Scene Selection" (P.27)
FOCUS	Focus can be adjusted manually. "Adjusting Focus Manually" (P.28)
FOCUS ASSIST	Focused subject is outlined in color for more precise focus. "Using Focus Assist" (P.28)
BRIGHTNESS ADJUST	Adjusts the overall brightness of the screen. "Adjusting Brightness" (P.29)
SHUTTER SPEED	Shutter speed can be adjusted. "Setting Shutter Speed (GZ-HM350/GZ-HM330)" (P.29)
WHITE BALANCE	Adjusts the color according to the light source. "Setting White Balance" (P.30)
BACKLIGHT COMP.	Corrects the image when the subject appears dark due to backlight. "Setting Backlight Compensation" (P.30)
METERING AREA/ TYPE	Enables you to adjust the brightness in the desired area. "Setting Metering Area" (P.31)
EFFECT	Records videos or still images with special effects such as sepia or black and white. "Recording with Effects" (P.31)
TELE MACRO	Enables close-up shots when using the telephoto (T) end of the zoom. "Taking Close-up Shots" (P.32)

### SCENE SELECT

Settings to suit the shooting condition can be selected.

Operating Details

"Scene Selection" (P.27)

### FOCUS

Focus can be adjusted automatically or manually.

Operating Details

"Adjusting Focus Manually" (P.28)

### FOCUS ASSIST

Focused subject is outlined in color for more precise focus.

Operating Details

"Using Focus Assist" (P.28)

### BRIGHTNESS ADJUST

Adjusts the overall brightness of the screen.

Operating Details

"Adjusting Brightness" (P.29)

### SHUTTER SPEED (GZ-HM350/GZ-HM330)

Shutter speed can be adjusted.

Operating Details

"Setting Shutter Speed (GZ-HM350/GZ-HM330)" (P.29)

### WHITE BALANCE

Adjusts the color according to the light source.

Operating Details

"Setting White Balance" (P.30)

### BACKLIGHT COMP.

Corrects the image when the subject appears dark due to backlight.

Operating Details

"Setting Backlight Compensation" (P.30)

### METERING AREA/TYPE

Enables you to adjust the brightness in the desired area.

Operating Details

"Setting Metering Area" (P.31)

### EFFECT

Records videos or still images with special effects such as sepia or black and white.

Operating Details

"Recording with Effects" (P.31)

### TELE MACRO

Enables close-up shots when using the telephoto (T) end of the zoom.

Operating Details

"Taking Close-up Shots" (P.32)

## Playback Menu (Video)

You can delete or look for specific videos.

Setting	Details
DELETE	Deletes unwanted videos. "Deleting the Currently Displayed File" (P.49) "Deleting Selected Files" (P.50) "Deleting All Files" (P.51)
PICTURE TITLE	Create a playlist simply by selecting a recording date and a title screen from the list. "Creating a Playlist with Title (GZ-HM350/GZ-HM330)" (P.62)
SEARCH	Refines the index screen of videos according to group, recording date, or event. "Group Search" (P.44) "Search Date" (P.44) "Search Event" (P.45)
PLAYBACK PLAYLIST	Play back the playlists that you have created. "Playing Back Playlists" (P.48)
EDIT PLAYLIST	Creates or edits a playlist. "Creating Playlists from the Recorded Videos" (P.63)
PLAYBACK OTHER FILE	Plays videos with defective management information. "Playing a Video with Defective Management Information" (P.41)
EDIT	<ul style="list-style-type: none"> <li>● COPY Copies files to another media. "Copying All Files" (P.72) "Copying Selected Files" (P.73)</li> <li>● MOVE Moves files to another media. "Moving All Files" (P.74) "Moving Selected Files" (P.75)</li> <li>● PROTECT/CANCEL Protects files from being deleted accidentally. "Protecting the Currently Displayed File" (P.52) "Protecting Selected Files" (P.53) "Protecting All Files" (P.54) "Releasing Protection of All Files" (P.54)</li> <li>● DIVIDE Divides a selected video into two. "Dividing Files" (P.57)</li> <li>● TRIMMING Select the required part of a video and save it as a new video file. "Capturing a Required Part in the Video" (P.59)</li> <li>● CHANGE EVENT REG. Changes the event that is registered. "Changing the Event of the Currently Displayed File" (P.55) "Changing the Event of the Selected Files" (P.56)</li> </ul>
SEAMLESS REC CTRL	Videos that are recorded on two separate media and with "SEAMLESS RECORDING" in the video recording menu enabled can be combined into a single video. "Combining Videos Recorded by Seamless Recording" (P.70)
WIPE/FADER	Adds effects at the beginning and end of recorded videos. "Playback with Special Effects" (P.42)
ON-SCREEN DISPLAY	Sets whether to show on-screen displays such as icons during playback. "ON-SCREEN DISPLAY" (P.111)

---

**DELETE**

Deletes unwanted videos.

Operating Details

"Deleting the Currently Displayed File" (P.49)

"Deleting Selected Files" (P.50)

"Deleting All Files" (P.51)

---

**PICTURE TITLE (GZ-HM350/GZ-HM330)**

Create a playlist simply by selecting a recording date and a title screen from the list.

Operating Details

"Creating a Playlist with Title (GZ-HM350/GZ-HM330)" (P.62)

---

**SEARCH**

Refines the index screen of videos according to group, recording date, or event.

Operating Details

"Group Search" (P.44)

"Search Date" (P.44)

"Search Event" (P.45)

---

**PLAYBACK PLAYLIST**

Play back the playlists that you have created.

Operating Details

"Playing Back Playlists" (P.48)

---

**EDIT PLAYLIST**

A list in which your favorite videos are arranged is called a playlist.

By creating a playlist, you can play back only your favorite videos in the order you like.

The original video file remains even when it is registered to a playlist.

Operating Details

"Creating Playlists from the Recorded Videos" (P.63)

---

**PLAYBACK OTHER FILE**

Plays videos with defective management information.

Operating Details

"Playing a Video with Defective Management Information" (P.41)



### EDIT

You can perform operations such as copying or protecting videos.

Setting	Details
COPY	Copies files to another media. "Copying All Files" (P.72) "Copying Selected Files" (P.73)
MOVE	Moves files to another media. "Moving All Files" (P.74) "Moving Selected Files" (P.75)
PROTECT/CANCEL	Protects files from being deleted accidentally. "Protecting the Currently Displayed File" (P.52) "Protecting Selected Files" (P.53) "Protecting All Files" (P.54) "Releasing Protection of All Files" (P.54)
DIVIDE	Divides a selected video into two. "Dividing Files" (P.57)
TRIMMING	Select the required part of a video and save it as a new video file. "Capturing a Required Part in the Video" (P.59)
CHANGE EVENT REG.	Changes the event that is registered. "Changing the Event of the Currently Displayed File" (P.55) "Changing the Event of the Selected Files" (P.56)

---

#### COPY

Copies files to another media.

Operating Details

"Copying All Files" (P.72)

"Copying Selected Files" (P.73)

---

#### MOVE

Moves files to another media.

Operating Details

"Moving All Files" (P.74)

"Moving Selected Files" (P.75)

---

#### PROTECT/CANCEL

Protects files from being deleted accidentally.

Operating Details

"Protecting the Currently Displayed File" (P.52)

"Protecting Selected Files" (P.53)

"Protecting All Files" (P.54)

"Releasing Protection of All Files" (P.54)

---

#### DIVIDE

Divides a selected video into two.

Operating Details

"Dividing Files" (P.57)

---

#### TRIMMING

Select the required part of a video and save it as a new video file.

Operating Details

"Capturing a Required Part in the Video" (P.59)

---

#### CHANGE EVENT REG.

Changes the event that is registered.

Operating Details

"Changing the Event of the Currently Displayed File" (P.55)

"Changing the Event of the Selected Files" (P.56)

---

#### SEAMLESS REC CTRL

Videos that are recorded on two separate media and with "SEAMLESS RECORDING" in the video recording menu enabled can be combined into a single video.

Operating Details

"Combining Videos Recorded by Seamless Recording" (P.70)

---

#### WIPE/FADER

Adds effects at the beginning and end of recorded videos.

Operating Details

"Playback with Special Effects" (P.42)

## ON-SCREEN DISPLAY

Sets whether to show on-screen displays such as icons during playback.

Setting	Details
OFF	No display at all.
DISPLAY ALL	Displays everything.
DISPLAY DATE ONLY	Displays the date only.

### Displaying the Item

1 Select the playback mode.

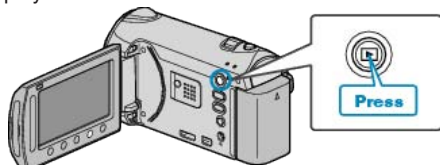

2 Select video mode.

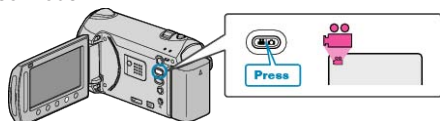

3 Touch  to display the menu.



4 Select "ON-SCREEN DISPLAY" and touch .



## Playback Menu (Still Image)

You can delete or look for specific still images.

Setting	Details
DELETE	Deletes unwanted still images. "Deleting the Currently Displayed File" (P.49) "Deleting Selected Files" (P.50) "Deleting All Files" (P.51)
SEARCH DATE	You can search and play still images according to recording dates. "Search Date" (P.44)
EDIT	<ul style="list-style-type: none"> <li>• COPY Copies files to another media. "Copying All Files" (P.72) "Copying Selected Files" (P.73)</li> <li>• MOVE Moves files to another media. "Moving All Files" (P.74) "Moving Selected Files" (P.75)</li> <li>• PROTECT/CANCEL Protects files from being deleted accidentally. "Protecting the Currently Displayed File" (P.52) "Protecting Selected Files" (P.53) "Protecting All Files" (P.54) "Releasing Protection of All Files" (P.54)</li> </ul>
SLIDE SHOW EFFECTS	Effects can be added to the transitions in slideshow playback. "SLIDE SHOW EFFECTS" (P.113)
ON-SCREEN DISPLAY	Sets whether to show on-screen displays such as icons during playback. "ON-SCREEN DISPLAY" (P.113)

### DELETE

Deletes unwanted still images.

Operating Details

"Deleting the Currently Displayed File" (P.49)

"Deleting Selected Files" (P.50)

"Deleting All Files" (P.51)

### SEARCH DATE

You can search and play still images according to recording dates.

Operating Details

"Search Date" (P.44)

### EDIT

You can perform operations such as copying or protecting still images.

Setting	Details
COPY	Copies files to another media. "Copying All Files" (P.72) "Copying Selected Files" (P.73)
MOVE	Moves files to another media. "Moving All Files" (P.74) "Moving Selected Files" (P.75)
PROTECT/CANCEL	Protects files from being deleted accidentally. "Protecting the Currently Displayed File" (P.52) "Protecting Selected Files" (P.53) "Protecting All Files" (P.54) "Releasing Protection of All Files" (P.54)

### COPY

Copies files to another media.

Operating Details

"Copying All Files" (P.72)

"Copying Selected Files" (P.73)

### PROTECT/CANCEL

Protects files from being deleted accidentally.

Operating Details

"Protecting the Currently Displayed File" (P.52)

"Protecting Selected Files" (P.53)

"Protecting All Files" (P.54)

"Releasing Protection of All Files" (P.54)

### MOVE

Moves files to another media.

Operating Details

"Moving All Files" (P.74)

"Moving Selected Files" (P.75)

### SLIDE SHOW EFFECTS

Effects can be added to the transitions in slideshow playback.

Setting	Details
SLIDE	Switches the screen by sliding in from right to left.
BLINDS	Switches the screen by dividing into vertical strips.
CHECKERBOARD	Switches the screen by changing through a checked pattern.
RANDOM	Switches the screen with a random effect from "SLIDE", "BLINDS", and "CHECKERBOARD".

#### Displaying the Item

1 Select the playback mode.

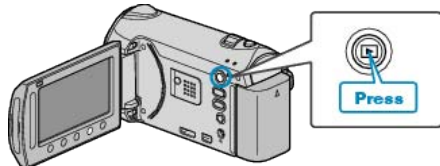

2 Select still image mode.

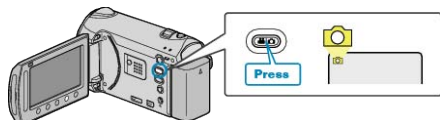

3 Touch  $\odot$  to display the menu.

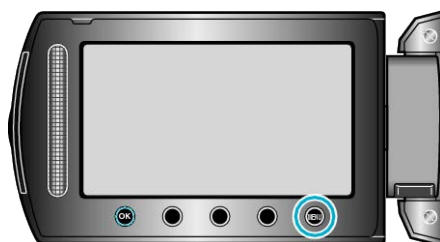

4 Select "SLIDE SHOW EFFECTS" and touch  $\odot$ .



### ON-SCREEN DISPLAY

Sets whether to show on-screen displays such as icons during playback.

Setting	Details
OFF	No display at all.
DISPLAY ALL	Displays everything.
DISPLAY DATE ONLY	Displays the date only.

#### Displaying the Item

1 Select the playback mode.

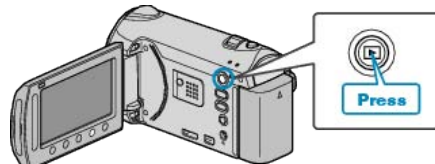

2 Select still image mode.

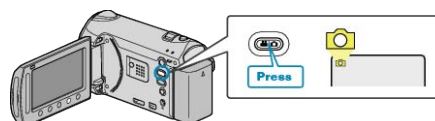

3 Touch  $\odot$  to display the menu.



4 Select "ON-SCREEN DISPLAY" and touch  $\odot$ .



## Display Settings Menu

You can adjust various display settings such as the LCD monitor's brightness, etc.

Setting	Details
LANGUAGE	The language on the display can be changed. "LANGUAGE" (☞ P.114)
DATE DISPLAY STYLE	Sets the order of year, month, day and the time display format (24H/12H). "DATE DISPLAY STYLE" (☞ P.114)
MONITOR BRIGHTNESS	Sets the brightness of the LCD monitor. "MONITOR BRIGHTNESS" (☞ P.115)
LCD BACKLIGHT	Sets the brightness of the backlight of the monitor. "LCD BACKLIGHT" (☞ P.116)
FOCUS ASSIST COLOR	Sets the color of the outline of a focused object when Focus Assist is used. "FOCUS ASSIST COLOR" (☞ P.116)

### LANGUAGE

The language on the display can be changed.

1 Touch to display the menu.

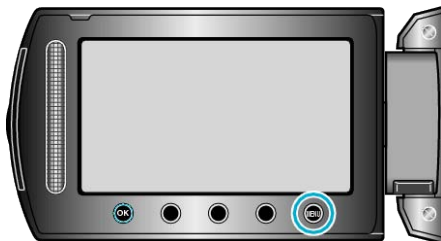

2 Select "DISPLAY SETTINGS" and touch .



3 Select "LANGUAGE" and touch .



4 Select the desired language and touch .



### DATE DISPLAY STYLE

Sets the order of year, month, day and the time display format (24H/12H).

1 Touch to display the menu.

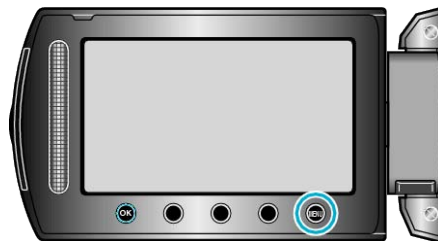

2 Select "DISPLAY SETTINGS" and touch .



3 Select "DATE DISPLAY STYLE" and touch .



4 Set the style of date and time display.



- For date display, set to any format from "month.day.year", "year.month.day", and "day.month.year".
- For time display, set to any format from "12h" and "24h".
- Touch the operation buttons "←" / "→" to move the cursor.
- After setting, touch .



## Clock Set Style

The clock set style of this unit varies with the models.

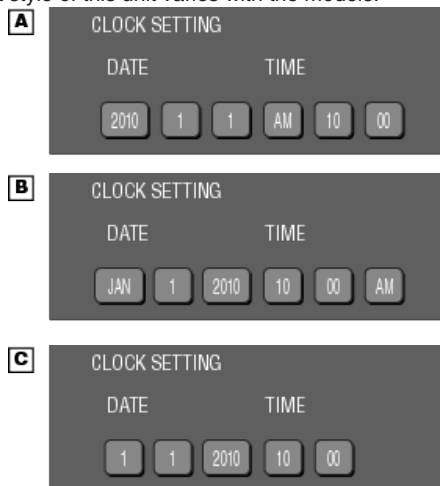

- The order of "Year, Month, Day, Time" changes according to the date display style.

## MONITOR BRIGHTNESS

Sets the brightness of the LCD monitor.

- 1 Touch **MENU** to display the menu.

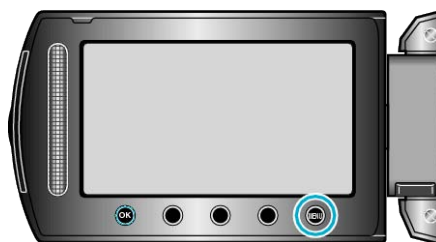

- 2 Select "DISPLAY SETTINGS" and touch **OK**.



- 3 Select "MONITOR BRIGHTNESS" and touch **OK**.



- 4 Adjust the brightness of the monitor.

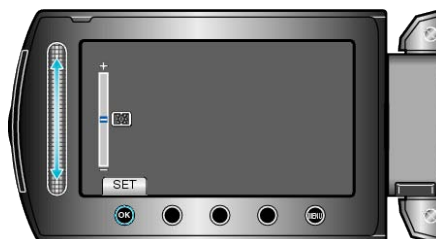

- Slide upward to increase the brightness.
- Slide downward to decrease the brightness.
- After setting, touch **OK**.

## LCD BACKLIGHT

Sets the brightness of the backlight of the monitor.

Setting	Details
BRIGHTER	Brightens the backlight of the monitor regardless of the surrounding conditions.
STANDARD	Helps to save battery life when selected.
AUTO	Sets the brightness automatically to "BRIGHTER" when using outdoors and to "STANDARD" when using in-doors.

### Displaying the Item

1 Touch  to display the menu.

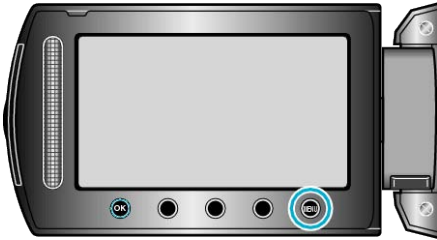

2 Select "DISPLAY SETTINGS" and touch .



3 Select "LCD BACKLIGHT" and touch .

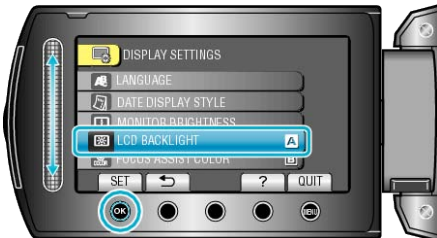

## FOCUS ASSIST COLOR

Sets the color of the outline of a focused object when Focus Assist is used.

Setting	Details
RED	Outlines the focused object in red.
GREEN	Outlines the focused object in green.
BLUE	Outlines the focused object in blue.

### Displaying the Item

1 Touch  to display the menu.

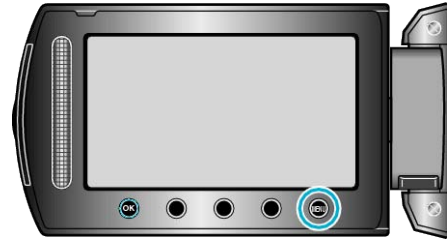

2 Select "DISPLAY SETTINGS" and touch .



3 Select "FOCUS ASSIST COLOR" and touch .



## CLOCK ADJUST

Resets the current time or sets to the local time when using this unit overseas.

Setting	Details
CLOCK SETTING	Resets the current time or changes the settings. "Resetting the Clock" (P.15)
AREA SETTING	Sets to the local time when using this unit overseas simply by selecting the destination. "Setting the Clock to Local Time when Traveling" (P.19)
SET FOR DAYLIGHT SAVING TIME	Sets whether daylight saving time is observed at the travel destination. "Setting Daylight Saving Time" (P.19)

### Memo:

- Daylight saving time is the system of setting the clock 1 hour ahead for a fixed period in summer. It is used mainly in the Western countries.

### Changing the Setting

- 1 Touch  to display the menu.



- 2 Select "CLOCK ADJUST" and touch .



### Basic Settings Menu

You can adjust various camera settings such as operation sound, etc.

Setting	Details
DEMO MODE	Introduces the special features of this unit in digest form. "DEMO MODE" (P.119)
AUTO POWER OFF	Prevents the situation of forgetting to turn off the power when this is set. "AUTO POWER OFF" (P.119)
OPERATION SOUND	Turns on or off the operation sound. "OPERATION SOUND" (P.120)
RECORD BUTTON	Displays the REC button on the LCD monitor and enables it to be used as the START/STOP button. "RECORD BUTTON" (P.120)
QUICK RESTART	Reduces the power consumption within 5 minutes after the LCD monitor is closed to 1/3 of that used during recording. "QUICK RESTART" (P.121)
REMOTE	Enables operation of this unit with the provided remote control. "REMOTE (GZ-HM350/GZ-HM330)" (P.121)
AUTO FINALIZE	Sets the created discs to a readable state that can be played back on a DVD writer. "AUTO FINALIZE (GZ-HM350/GZ-HM330)" (P.122)
UPDATE	Updates the functions of this unit to the latest version. "UPDATE" (P.122)
FACTORY PRESET	Returns all the settings to their default values. "FACTORY PRESET" (P.123)

## DEMO MODE

Starts playback of the demo mode which introduces the features of this unit.

Setting	Details
OFF	Deactivates the function.
ON	Plays a demonstration of the special features of this unit.

### Displaying Demo Mode

- ① Remove the battery pack and SD card.
- ② Connect the AC adapter.
- ③ Open the LCD monitor and turn on the power.
  - Demonstration starts playing after 3 minutes.
  - To stop playback, touch .

#### Memo:

- This mode is not available in the playback mode.

### Displaying the Item

- 1 Touch  to display the menu.

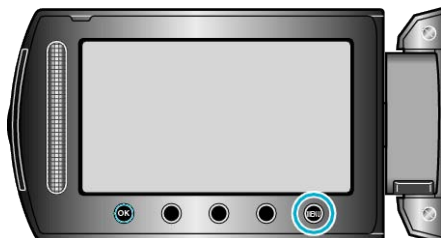

- 2 Select "BASIC SETTINGS" and touch .



- 3 Select "DEMO MODE" and touch .



## AUTO POWER OFF

Prevents the situation of forgetting to turn off the power when this is set.

Setting	Details
OFF	Power is not turned off even if this unit is not operated for 5 minutes.
ON	Turns off the power automatically if this unit is not operated for 5 minutes.

#### Memo:

- When using battery, power is turned off automatically if this unit is not operated for 5 minutes.
- When using the AC adapter, this unit goes into standby mode.

### Displaying the Item

- 1 Touch  to display the menu.



- 2 Select "BASIC SETTINGS" and touch .



- 3 Select "AUTO POWER OFF" and touch .

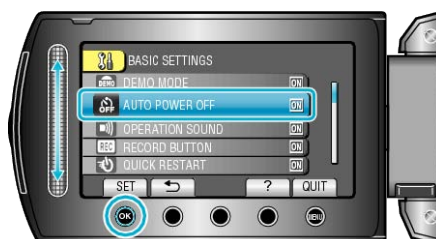



## OPERATION SOUND

Turns on or off the operation sound.

Setting	Details
OFF	Turns off the operation sound.
ON	Turns on the operation sound.

### Displaying the Item

1 Touch  to display the menu.

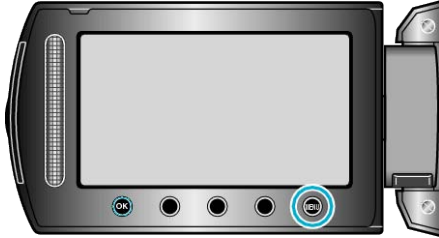

2 Select "BASIC SETTINGS" and touch .



3 Select "OPERATION SOUND" and touch .



## RECORD BUTTON

Displays the REC button on the LCD monitor and enables it to be used as the START/STOP button.

Setting	Details
OFF	No display.
ON	Displays the REC button on the LCD monitor.

### Displaying the Item

1 Touch  to display the menu.

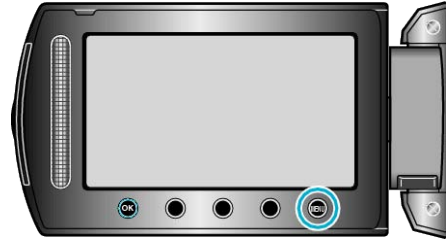

2 Select "BASIC SETTINGS" and touch .



3 Select "RECORD BUTTON" and touch .



### QUICK RESTART

Enables recording to be performed immediately when the LCD monitor is opened.

Setting	Details
OFF	Deactivates the function.
ON	Enables the power to turn on quickly when the LCD monitor is opened again within 5 minutes.

#### Displaying the Item

1 Touch **OK** to display the menu.

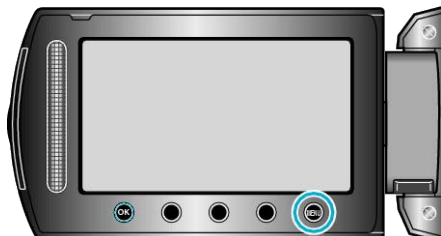

2 Select "BASIC SETTINGS" and touch **OK**.



3 Select "QUICK RESTART" and touch **OK**.



- The power consumption within 5 minutes after the LCD monitor is closed is reduced to 1/3 of that used during recording.

### REMOTE (GZ-HM350/GZ-HM330)

Enables operation of this unit with the provided remote control.

Setting	Details
OFF	Does not receive operation signals from the remote control.
ON	Receives operation signals from the remote control.

#### Displaying the Item

1 Touch **OK** to display the menu.

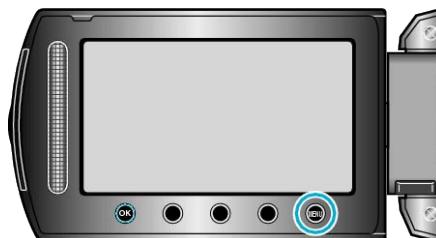

2 Select "BASIC SETTINGS" and touch **OK**.



3 Select "REMOTE" and touch **OK**.



### AUTO FINALIZE (GZ-HM350/GZ-HM330)

Sets the created discs to a readable state that can be played back on a DVD writer.

Setting	Details
OFF	Makes created discs recordable (not playable on devices other than this unit).
ON	Finalizes the created discs so that they can be played back on a DVD writer.

#### Memo:

- DVD-Video discs are automatically finalized regarding of the setting.

### Displaying the Item

- 1 Touch **MENU** to display the menu.

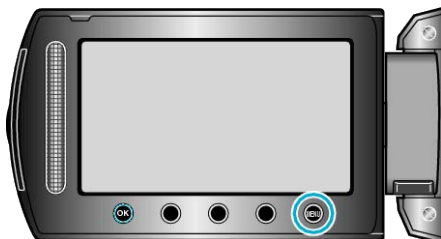

- 2 Select "BASIC SETTINGS" and touch **OK**.



- 3 Select "AUTO FINALIZE" and touch **OK**.



### UPDATE

Updates the functions of this unit to the latest version.

For details, refer to the JVC homepage.

(When no program to update the software of this unit is available, nothing will be provided on the homepage.)

## FACTORY PRESET

Returns all the settings to their default values.

1 Touch  to display the menu.

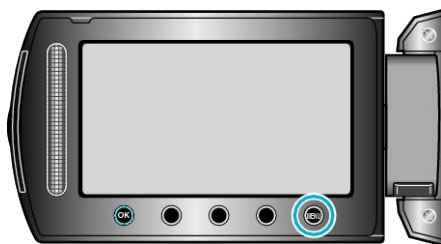

2 Select "BASIC SETTINGS" and touch .



3 Select "FACTORY PRESET" and touch .



4 Select "YES" and touch .



• All settings return to their default values.

## Connection Settings Menu

You can adjust various settings for connecting to a TV or DVD recorder.

Setting	Details
DISPLAY ON TV	Displays icons and date/time on a TV screen. "DISPLAY ON TV" (P.124)
VIDEO OUTPUT	Sets the aspect ratio (16:9 or 4:3) according to the connecting TV. "VIDEO OUTPUT" (P.124)
COMPONENT OUTPUT	Sets the definition of the video output from the COMPONENT connector. "COMPONENT OUTPUT" (P.125)
HDMI OUTPUT	Sets the definition of the video output from the HDMI mini connector. "HDMI OUTPUT" (P.125)
HDMI CONTROL	Sets the linked operations ON/OFF when the TV and this unit are connected using the HDMI mini connector. "HDMI CONTROL" (P.126)

### DISPLAY ON TV

Displays icons and date/time on a TV screen.

Setting	Details
OFF	Does not display icons and date/time on TV.
ON	Displays icons and date/time on TV.

#### Displaying the Item

1 Touch **MEM** to display the menu.

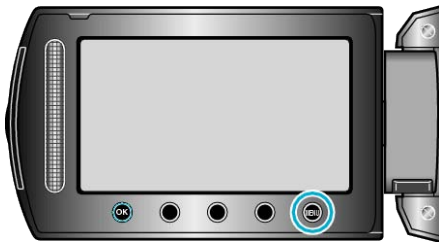

2 Select "CONNECTION SETTINGS" and touch **OK**.



3 Select "DISPLAY ON TV" and touch **OK**.

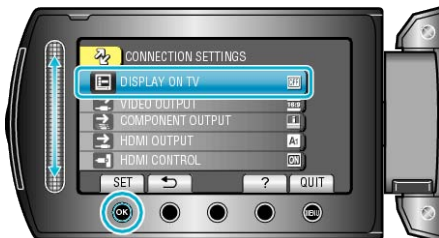

### VIDEO OUTPUT

Sets the aspect ratio (16:9 or 4:3) according to the connecting TV.

Setting	Details
16:9	Select this when connecting to a widescreen TV (16:9).
4:3	Select this when connecting to a conventional TV (4:3).

#### Displaying the Item

1 Touch **MEM** to display the menu.

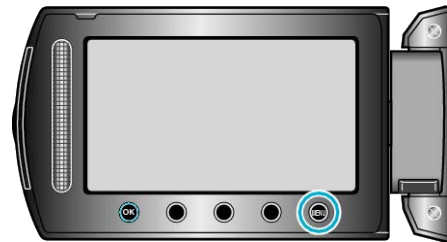

2 Select "CONNECTION SETTINGS" and touch **OK**.



3 Select "VIDEO OUTPUT" and touch **OK**.





### COMPONENT OUTPUT

Sets the definition of the video output from the COMPONENT connector.

Setting	Details
576i	Outputs at 576i.
1080i	Outputs at 1080i.

#### Displaying the Item

1 Touch **OK** to display the menu.

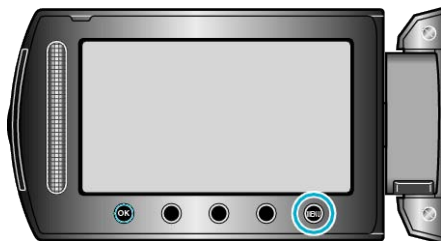

2 Select "CONNECTION SETTINGS" and touch **OK**.



3 Select "COMPONENT OUTPUT" and touch **OK**.



### HDMI OUTPUT

Sets the definition of the video output from the HDMI mini connector.

Setting	Details
AUTO 1	It is recommended to select "AUTO 1" usually.
AUTO 2	Select this when the video is not output in "AUTO 1" correctly.
576p	Select this when the video is not output in "AUTO 2" correctly.

#### Memo:

- "1080P" will be displayed on the LCD monitor if a 1080p compatible TV is connected to this unit in playback mode.

#### Displaying the Item

1 Touch **OK** to display the menu.

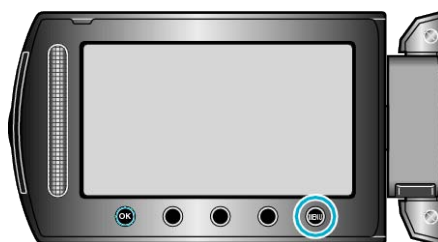

2 Select "CONNECTION SETTINGS" and touch **OK**.



3 Select "HDMI OUTPUT" and touch **OK**.

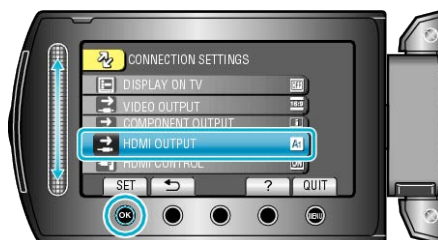

### HDMI CONTROL

Sets the linked operations ON/OFF when the TV and this unit are connected using the HDMI mini connector.

Setting	Details
OFF	Turns off linked operations.
ON	Turns on linked operations.

### Displaying the Item

- 1 Touch **MEM** to display the menu.

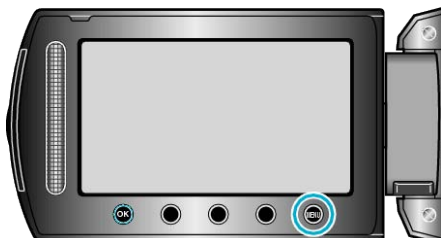

- 2 Select "CONNECTION SETTINGS" and touch **OK**.



- 3 Select "HDMI CONTROL" and touch **OK**.



## Media Settings Menu

You can perform various settings for the recording media.

Setting	Details
REC MEDIA FOR VIDEO	Sets the recording/playback media of videos. "REC MEDIA FOR VIDEO (GZ-HM350/GZ-HM330)" (P.127)
VIDEO SLOT SELECTION	Sets the recording/playback SD slot of videos. "VIDEO SLOT SELECTION (GZ-HM300)" (P.127)
REC MEDIA FOR IMAGE	Sets the recording/playback media of still images. "REC MEDIA FOR IMAGE (GZ-HM350/GZ-HM330)" (P.128)
IMAGE SLOT SELECTION	Sets the recording/playback SD slot of still images. "IMAGE SLOT SELECTION (GZ-HM300)" (P.128)
FORMAT BUILT-IN MEM.	Deletes all files on the built-in memory. "FORMAT BUILT-IN MEM. (GZ-HM350/GZ-HM330)" (P.129)
FORMAT SD CARD	Deletes all files on the SD card. "FORMAT SD CARD" (P.129)
ERASE ALL DATA	Execute this process when disposing of this unit or passing it to another person. "ERASE ALL DATA (GZ-HM350/GZ-HM330)" (P.130)

### REC MEDIA FOR VIDEO (GZ-HM350/GZ-HM330)

Sets the recording/playback media of videos.

Setting	Details
BUILT-IN MEMORY	Records videos to this unit's built-in memory.
SD CARD	Records videos to the SD card.

#### Displaying the Item

1 Touch **OK** to display the menu.



2 Select "MEDIA SETTINGS" and touch **OK**.



3 Select "REC MEDIA FOR VIDEO", and touch **OK**.



### VIDEO SLOT SELECTION (GZ-HM300)

Sets the recording/playback media of videos.

Setting	Details
SLOT A	Records videos to the SD card in slot A.
SLOT B	Records videos to the SD card in slot B.

#### Displaying the Item

1 Touch **OK** to display the menu.

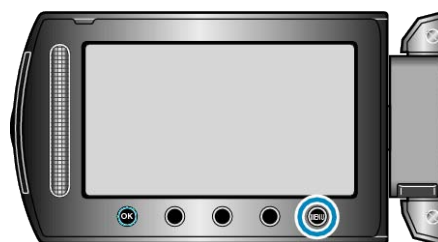

2 Select "MEDIA SETTINGS" and touch **OK**.



3 Select "VIDEO SLOT SELECTION" and touch **OK**.



## REC MEDIA FOR IMAGE (GZ-HM350/GZ-HM330)

Sets the recording/playback media of still images.

Setting	Details
BUILT-IN MEMORY	Records still images to this unit's built-in memory.
SD CARD	Records still images to the SD card.

### Displaying the Item

- 1 Touch **MEM** to display the menu.

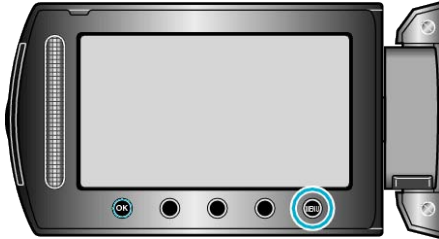

- 2 Select "MEDIA SETTINGS" and touch **OK**.



- 3 Select "REC MEDIA FOR IMAGE" and touch **OK**.



## IMAGE SLOT SELECTION (GZ-HM300)

Sets the recording/playback media of still images.

Setting	Details
SLOT A	Records still images to the SD card in slot A.
SLOT B	Records still images to the SD card in slot B.

### Displaying the Item

- 1 Touch **MEM** to display the menu.

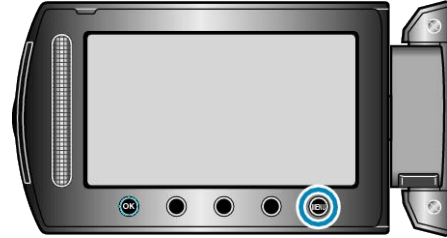

- 2 Select "MEDIA SETTINGS" and touch **OK**.



- 3 Select "IMAGE SLOT SELECTION" and touch **OK**.

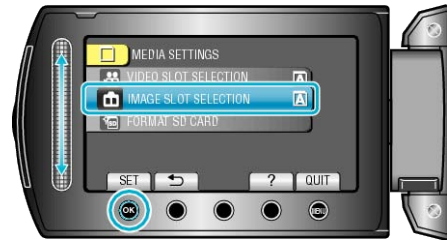

**FORMAT BUILT-IN MEM. (GZ-HM350/GZ-HM330)**

Deletes all files on the built-in memory.

Setting	Details
FILE	Deletes all files on the built-in memory.
FILE + MANAGEMENT NO	Deletes all files on the built-in memory and resets the folder and file numbers to "1".

**CAUTION:**

- All data on the built-in memory will be deleted when it is formatted. Copy all files on the built-in memory to a PC before formatting.
- Make sure that the battery pack is fully charged or connect the AC adapter as the formatting process may take some time.

**Displaying the Item**

- 1 Touch  to display the menu.

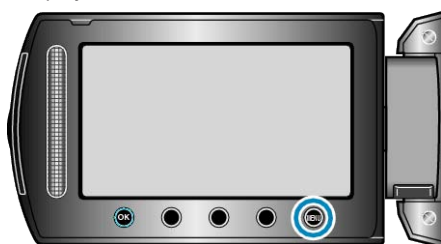

- 2 Select "MEDIA SETTINGS" and touch .



- 3 Select "FORMAT BUILT-IN MEM." and touch .

**FORMAT SD CARD**

Deletes all files on the SD card.

Setting	Details
FILE	Deletes all files on the SD card.
FILE + MANAGEMENT NO	Deletes all files on the SD card and resets the folder and file numbers to "1".

**CAUTION:**

- Not available for selection when no SD card is inserted.
- All data on the card will be deleted when it is formatted. Copy all files on the card to a PC before formatting.
- Make sure that the battery pack is fully charged or connect the AC adapter as the formatting process may take some time.
- Format a newly purchased SD card with this unit before use.

**Displaying the Item**

- 1 Touch  to display the menu.

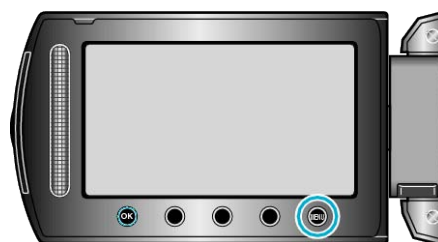

- 2 Select "MEDIA SETTINGS" and touch .



- 3 Select "FORMAT SD CARD" and touch .



- 4 GZ-HM300  
Select the card slot.

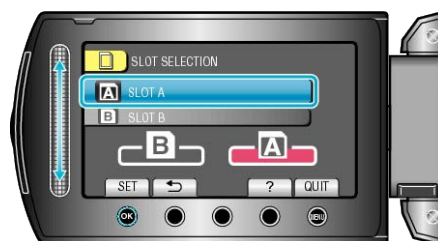

- For GZ-HM350/GZ-HM330, proceed to step 5.

- 5 Select the setting and touch .



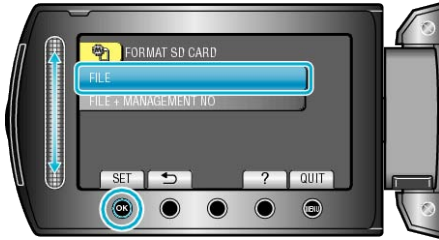

6 Select "YES" and touch .



• After formatting, touch .

## ERASE ALL DATA (GZ-HM350/GZ-HM330)

Execute this process when disposing of this unit or passing it to another person.

1 Touch  to display the menu.

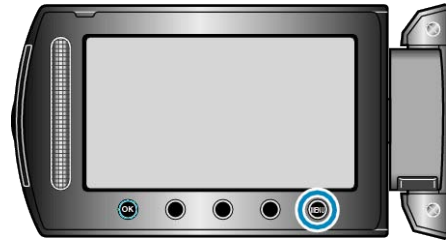

2 Select "MEDIA SETTINGS" and touch .



3 Select "ERASE ALL DATA" and touch .



4 Select "YES" and touch .



• After deleting the data, touch .

### CAUTION:

• Connect the AC adapter as it may take some time to delete data.

### Memo:

• Repeat the process to make data restoration even more difficult.

## Front

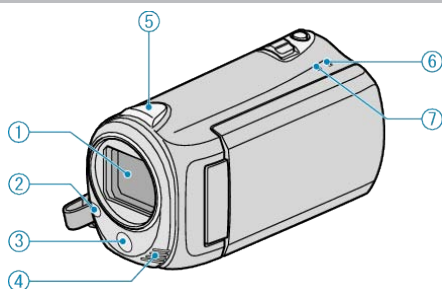
**1** Lens

- Do not touch the lens and lens cover.
  - Do not cover the lens with your fingers during video recording.
- "Attaching the Lens Cap (GZ-HM300)" (P.18)

**2** Light (GZ-HM350/GZ-HM330)

- Turn on the light when shooting in dark places.
- "LIGHT (GZ-HM350/GZ-HM330)" (P.98)

**3** Remote Sensor (GZ-HM350/GZ-HM330)

- Do not cover the sensor with your fingers when using the remote control.

**4** Stereo Microphone

- Do not cover the microphone with your fingers during video recording.

**5** Camera Sensor

- Do not cover the sensor with your fingers during video recording.

**6** POWER/CHARGE Lamp

- Lights up: Power "ON"
- Blinks: Charging in progress
- Goes out: Charging finished

**7** ACCESS Lamp

- Recording or playback is in progress when the lamp lights up or blinks.
- Do not remove the battery pack, AC adapter, or SD card.

## Rear

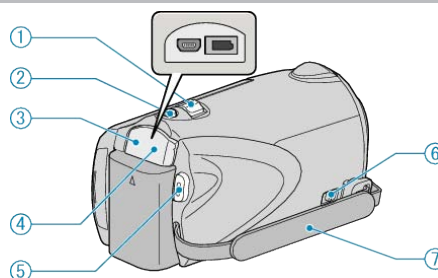
**1** Zoom/Volume Lever

- During shooting: Adjusts the shooting range.
- During playback (index screen): Changes the number of images to display.
- During video playback: Adjusts the volume.

**2** SNAPSHOT (Still image recording) Button

- Takes a still image.

**3** USB Terminal

- Connects to PC using a USB cable.

**4** DC Terminal

- Connects to an AC adapter to charge the battery.

**5** START/STOP (Video recording) Button

- Starts/stops video recording.

**6** Grip Belt Release Lever

- Allows the grip belt to be removed and used as a hand strap.

**7** Grip Belt

- Pass your hand through the grip belt to hold this unit firmly.
- "Holding this Unit" (P.16)

**Bottom**

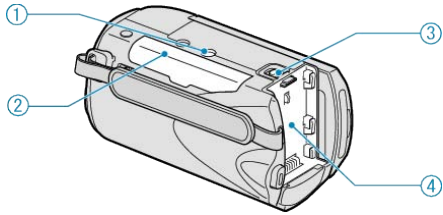

**1** Tripod Mounting Hole

"Tripod Mounting" ( P.18)

**2** SD Card Slot

- Insert an optional SD card.

"Inserting an SD Card (GZ-HM350/GZ-HM330)" ( P.13)

"Inserting an SD Card (GZ-HM300)" ( P.14)

**3** Battery Release Lever

"Charging the Battery Pack" ( P.11)

**4** Battery Mount

"Charging the Battery Pack" ( P.11)

**Interior**

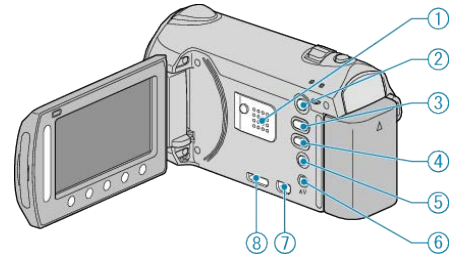

**1** Speaker

- Outputs audio sound during video playback.

**2** (Play) Button

- Switches between the recording and playback modes.

**3** (Video/Still Image) Button

- Switches between video and still image.

**4** UPLOAD/EXPORT\* (Upload/Export to iTunes\*) Button

- Recording: Takes videos in YouTube™ or iTunes\* format.
- Playback: Changes the video to YouTube™ or iTunes\* format. (\*GZ-HM350/GZ-HM330 only)

**5** (Power/Info) Button

- Recording: Displays the remaining time (for video only) and battery power.
- Playback: Displays file information such as recording date.
- Press and hold to turn the power on/off while the LCD monitor is opened.

**6** AV Terminal

- Connects to a TV.

**7** COMPONENT Terminal

- Connects to a TV.

**8** HDMI Terminal

- Connects to an HDMI TV.

## LCD Monitor

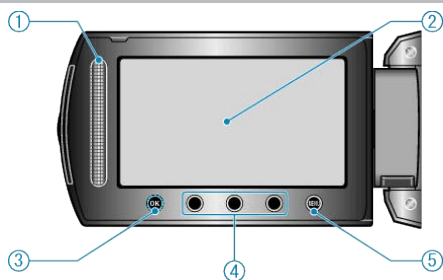

### 1 Slider LASER TOUCH OPERATION

- Selects items or images from the menu or index screen.  
"Using the Operation Buttons" (P.16)

### 2 LCD Monitor

- Turns the power on/off by opening and closing.
- Enables self-portraits to be taken by rotating the monitor.

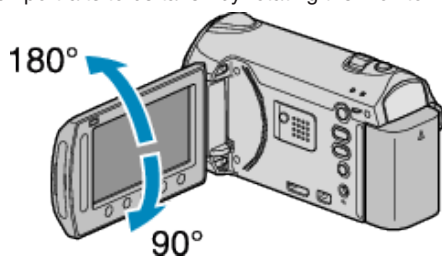

### 3 OK Button

- Confirms the selected item or image.

### 4 Operation Buttons

- Functions of the operation buttons may be displayed.

### 5 MENU Button

- Displays the settings menu.

### CAUTION:

- Do not press against the surface with force or subject it to strong impact.  
Doing so may damage or break the screen.

## Common Recording Indications

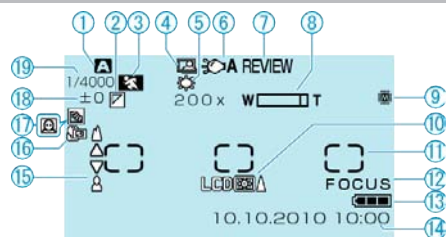

### 1 Recording Mode

"Taking Videos in Auto Mode" ( P.20)

"Manual Recording" ( P.26)

### 2 Effect

"EFFECT" ( P.107)

### 3 Scene Select

"SCENE SELECT" ( P.107)

### 4 Auto REC

"Recording Automatically by Sensing Movements (AUTO REC)" ( P.36)

### 5 White Balance

"WHITE BALANCE" ( P.107)

### 6 Light (GZ-HM350/GZ-HM330)

"LIGHT (GZ-HM350/GZ-HM330)" ( P.98)

### 7 Quick Review

"Taking Videos in Auto Mode" ( P.20)

"Taking Still Images in Auto Mode" ( P.23)

### 8 Zoom

"ZOOM" ( P.99)

### 9 Media

"REC MEDIA FOR VIDEO (GZ-HM350/GZ-HM330)" ( P.127)

"REC MEDIA FOR IMAGE (GZ-HM350/GZ-HM330)" ( P.128)

"VIDEO SLOT SELECTION (GZ-HM300)" ( P.127)

"IMAGE SLOT SELECTION (GZ-HM300)" ( P.128)

### 10 Monitor Backlight

"LCD BACKLIGHT" ( P.116)

### 11 Metering Area "SPOT"

"METERING AREA/TYPE" ( P.107)

### 12 Focus Assist

"FOCUS ASSIST" ( P.107)

### 13 Battery Indicator

"Remaining Recording Time/Battery Power" ( P.37)

### 14 Date/Time

"Clock Setting" ( P.15)

### 15 Focus

"FOCUS" ( P.107)

### 16 Tele Macro

"TELE MACRO" ( P.107)

### 17 Backlight Compensation

"BACKLIGHT COMP." ( P.107)

• : Face Priority AE/AF

"FACE PRIORITY AE/AF" ( P.98)

### 18 Brightness

"BRIGHTNESS ADJUST" ( P.107)

### 19 Shutter Speed

"SHUTTER SPEED (GZ-HM350/GZ-HM330)" ( P.107)

## Video Recording

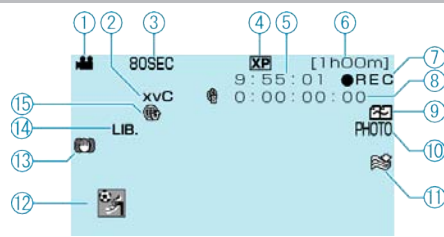

### 1 Video Mode

" (Video/Still Image) Button" ( P.132)

### 2 x.v.Color

"x.v.Color" ( P.101)

### 3 Time-Lapse Recording

"Recording at Intervals (TIME-LAPSE RECORDING)" ( P.35)

### 4 Video Quality

"VIDEO QUALITY" ( P.99)

### 5 Scene Counter

### 6 Remaining Recording Time

"Taking Videos in Auto Mode" ( P.21)

### 7 Recording in Progress

"Taking Videos in Auto Mode" ( P.21)

### 8 Time-Lapse Recording Counter

### 9 Seamless Recording

"SEAMLESS RECORDING" ( P.101)

### 10 Still Image Recording

"Capturing Still Images During Video Recording" ( P.22)

### 11 Wind Cut

"WIND CUT" ( P.102)

### 12 Event Recording

"Registering Files to Events Before Recording" ( P.32)

### 13 Digital Image Stabilizer

"Reducing Camera Shake" ( P.23)

### 14 EXPORT Recording (GZ-HM350/GZ-HM330)

"Taking Videos in iTunes Format (GZ-HM350/GZ-HM330)" ( P.34)

### 15 UPLOAD Recording

"Taking Videos in YouTube™ Format" ( P.33)



## Still Image Recording

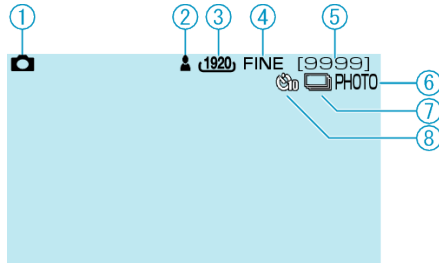

### 1 Still Image Mode

" / (Video/Still Image) Button" (P.132)

### 2 Focus

"Taking Still Images in Auto Mode" (P.23)

### 3 Image Size

"IMAGE SIZE" (P.105)

### 4 Image Quality

"IMAGE QUALITY" (P.106)

### 5 Remaining Number of Shots

"Taking Still Images in Auto Mode" (P.23)

### 6 Recording in Progress

### 7 Continuous Shooting

"SHUTTER MODE" (P.105)

### 8 Self-Timer

"SELF-TIMER" (P.104)

## Video Playback

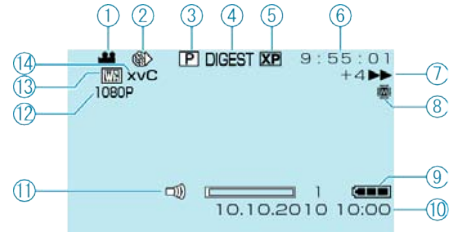

### 1 Video Mode

" / (Video/Still Image) Button" (P.132)

### 2 Time-Lapse Recording

"TIME-LAPSE RECORDING" (P.100)

### 3 Playlist Playback

"PLAYBACK PLAYLIST" (P.109)

### 4 Digest Playback

"Checking the Content of Videos Quickly" (P.41)

### 5 Video Quality

"VIDEO QUALITY" (P.99)

### 6 Scene Counter

### 7 Operation Indicator

• The number on the left shows the speed of forward/reverse search.

"Playing Back Videos" (P.40)

### 8 Media

"REC MEDIA FOR VIDEO (GZ-HM350/GZ-HM330)" (P.127)

"VIDEO SLOT SELECTION (GZ-HM300)" (P.127)

### 9 Battery Indicator

"Remaining Recording Time/Battery Power" (P.37)

### 10 Date/Time

### 11 Speaker Volume Adjustment

### 12 Output with 1080p

"HDMI OUTPUT" (P.125)

### 13 Wipe/Fader

"Playback with Special Effects" (P.42)



### 14 x.v.Color

"x.v.Color" (P.101)

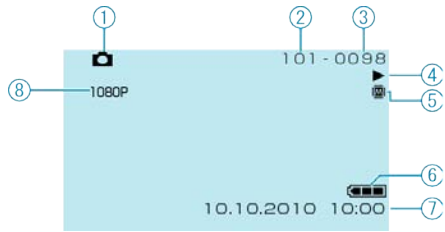
### Still Image Playback



**1** Still Image Mode

" /  (Video/Still Image) Button" (P.132)

**2** Folder Number

**3** File Number

**4** Operation Indicator

"Playing Back Still Images" (P.43)

**5** Media

"REC MEDIA FOR IMAGE (GZ-HM350/GZ-HM330)" (P.128)

"IMAGE SLOT SELECTION (GZ-HM300)" (P.128)

**6** Battery Indicator

"Remaining Recording Time/Battery Power" (P.37)

**7** Date/Time

"Clock Setting" (P.15)

**8** Output with 1080p

"HDMI OUTPUT" (P.125)

## Battery Pack

### Unable to turn on the power when using the battery pack.

Recharge the battery pack.  
"Charging the Battery Pack" (P.11)

If the terminal of this unit or the battery pack is dirty, wipe it with a cotton swab or something similar.

If you use any other battery packs besides JVC battery packs, safety and performance can not be guaranteed. Be sure to use JVC battery packs.

### Short usage time even after charging.

Battery deterioration occurs when a battery pack is charged repeatedly. Replace the battery pack with a new one.  
"Optional Accessories" (P.20)

### Unable to charge the battery pack.

When the battery pack is fully charged, the lamp does not flash.  
If the terminal of this unit or the battery pack is dirty, wipe it with a cotton swab or something similar.  
Using a non-original battery pack may result in damage to this unit. Be sure to use an original battery pack.

### The remaining battery display is not correct.

Remaining battery power is not displayed when the AC adapter is connected.  
If this unit is used for long periods of time in high or low temperatures, or if the battery pack is repeatedly charged, the amount of remaining battery may not be displayed correctly.

## Recording

### Recording/snapshot cannot be performed.

Check the START/STOP switch.  
"Rear" (P.131)  
Set to the recording mode with the  button.  
"Interior" (P.132)  
Check the  mode.

### Recording stops automatically.

Recording stops automatically as it cannot be performed for 12 or more consecutive hours according to specifications. (It may take some time to resume recording.)  
Turn off the power, wait for a while, and start recording again. (This unit stops automatically to protect the circuit when the temperature rises.)  
Insert a commercially available SD card, and set "REC MEDIA FOR VIDEO" and "REC MEDIA FOR IMAGE" in the media settings menu to "SD CARD". (There may be a malfunction with the built-in memory.)

### The image stabilizer does not work.

The image stabilizer does not work when recording still images.

### The continuous shooting speed of still images is slow.

The continuous shooting speed will drop if this function is used repeatedly.  
Continuous shooting speed may drop depending on the SD card or under certain recording conditions.

### The focus is not adjusted automatically.

If you are recording in a dark place or a subject that has no contrast between dark and light, adjust the focus manually.  
"Adjusting Focus Manually" (P.28)  
Wipe the lens with a lens cleaning cloth.  
Cancel manual focus on the manual recording menu.  
"Adjusting Focus Manually" (P.28)  
Use the Focus Assist function to adjust focus more precisely.  
"FOCUS ASSIST" (P.107)

### Digital zoom does not work.

Digital zoom is not available in the still image recording mode.  
Zoom operation is not available in time-lapse shooting. (Simultaneous still image recording and image stabilizer are also not available.)  
To use digital zoom, set "ZOOM" in the menu to "80x" or "200x".  
"ZOOM" (P.99)

### Vertical lines appear on recorded images.

Such a phenomenon occurs when shooting a subject illuminated by bright light. This is not a malfunction.

### Mosaic-type noise occurs when recording scenes with fast movements or extreme changes in brightness.

Set the "VIDEO QUALITY" to "UXP" or "XP" for recording.

### Card

#### Cannot insert the SD card.

Make sure not to insert the card in the wrong direction.  
"Inserting an SD Card (GZ-HM350/GZ-HM330)" (P.13)

#### Unable to copy to SD card.

To record to the card, it is necessary to perform media settings.  
"REC MEDIA FOR VIDEO (GZ-HM350/GZ-HM330)" (P.127)  
"REC MEDIA FOR IMAGE (GZ-HM350/GZ-HM330)" (P.128)  
To use cards that have been used on other devices, it is necessary to format (initialize) the card using "FORMAT SD CARD" from media settings.  
"FORMAT SD CARD" (P.129)

### Playback

#### Sound or video is interrupted.

Sometimes playback is interrupted at the connecting section between two scenes. This is not a malfunction.

#### Cannot find a recorded file.

Cancel group display and date search functions.  
"Searching for a Specific Video/Still Image" (P.44)  
Change the setting in "REC MEDIA FOR VIDEO" or "REC MEDIA FOR IMAGE". (Files on other media are not displayed.)  
"REC MEDIA FOR VIDEO (GZ-HM350/GZ-HM330)" (P.127)  
"REC MEDIA FOR IMAGE (GZ-HM350/GZ-HM330)" (P.128)  
Select "PLAYBACK OTHER FILE" then search the videos on the index screen. (Video files that have damaged management information can be played back.)  
"Playing a Video with Defective Management Information" (P.41)

#### No date/time display.

Set "ON-SCREEN DISPLAY" in the menu accordingly.  
"ON-SCREEN DISPLAY" (P.111)  
Set "DISPLAY ON TV" in the menu to "ON".  
"DISPLAY ON TV" (P.124)

#### Images do not appear on the TV properly.

Disconnect the cable and connect again.  
Turn off and on this unit again.  
When connected via the component connector, check if the setting of "COMPONENT OUTPUT" in the connections setting menu is suitable for the connected TV. (Set to "1080i" by default)  
"COMPONENT OUTPUT" (P.125)

#### Images are projected vertically on the TV.

Set "VIDEO OUTPUT" in the connection settings menu to "4:3".  
"VIDEO OUTPUT" (P.124)  
Adjust the TV's screen accordingly.

#### Unable to play back DVD with title.

The title will not be played back if you connect this unit to a DVD writer (optional).

#### Some functions cannot be used when playing back a backup BD/DVD through a BD/DVD writer connected to this unit.

The following functions cannot be used for a backup BD/DVD.  
When playing back video  
- Search index by date  
- Wipe/fader effects  
When playing back still image  
- Slideshow effects

## Editing/Copying

### Unable to create DVD with a DVD writer.

The USB cable is not connected correctly.

(☞ P.76)

If the provided software Everio MediaBrowser is not installed, some functions may not work properly.

(☞ P.88)

Use a PC that supports DVD-R/RW.

### CREATE DVD menu does not disappear.

While the USB cable is connected, the "CREATE DVD" menu is displayed.

"Preparing a DVD Writer (CU-VD50)" (☞ P.76)

### Unable to turn off the CREATE DVD menu.

Turn off the power of this unit and the DVD writer, or remove the AC adapter.

### Unable to delete file.

Files that are protected cannot be deleted. Release protection before deleting the file.

"Protecting Files" (☞ P.52)

### Unable to copy/move files to SD card.

If the SD card is write protected, set it to off.

## PC

### Unable to copy files to the PC's HDD.

Connect the USB cable correctly.

"Backing Up All Files" (☞ P.89)

If the provided software Everio MediaBrowser is not installed, some functions may not work properly.

"Installing the Provided Software" (☞ P.88)

Before making backup, make sure that enough free space is left in the PC's hard disk (HDD).

Still images cannot be recorded to disk using the provided software.

### Unable to copy files to DVD with a PC.

To record to discs, a recordable DVD drive is required for the PC in use.

### I am using a Mac computer.

Copy the files to a Mac computer using the following method.

"Copying to Mac Computer" (☞ P.94)

### Cannot upload the file to YouTube™.

Check if you have created an account with YouTube™. (You need a YouTube™ account to upload files to YouTube™.)

Upload recording can only be performed for up to 10 minutes, the time limit of YouTube™.

Changing videos to the file format for uploading cannot be performed on this unit.

Refer to "Q&A", "Latest Information", "Download Information", etc. in "Click for Latest Product Info" in the help file of the provided Everio MediaBrowser software.

### Cannot export the file to iTunes. (GZ-HM350/GZ-HM330)

Refer to "Q&A", "Latest Information", "Download Information", etc. in "Click for Latest Product Info" in the help file of the provided Everio MediaBrowser software.



### Screen/Image

#### The LCD monitor is difficult to see.

The LCD monitor may be difficult to see if used in bright areas such as under direct sunlight.

#### A band or a ball of bright light appears on the LCD monitor.

Change the direction of this unit to prevent the light source from coming into view. (A band or a ball of bright light may appear when there is a bright light source near this unit, but this is not a malfunction.)

#### The recorded subject is too dark.

Use backlight compensation when the background is bright and the subject is dark.

"Setting Backlight Compensation" (P.30)

Use "LIGHT" in the menu.

"LIGHT (GZ-HM350/GZ-HM330)" (P.98)

Use "GAIN UP" in the menu.

"GAIN UP" (P.100)

Use "NIGHT EYE" in "SCENE SELECT" of the manual settings menu.

"Scene Selection" (P.27)

Set "BRIGHTNESS ADJUST" in the manual settings menu to the "+" side.

"Adjusting Brightness" (P.29)

#### The recorded subject is too bright.

Set the backlight compensation to off if it is being used.

"Setting Backlight Compensation" (P.30)

Use "SPOTLIGHT" in "SCENE SELECT" of the manual settings menu.

"Scene Selection" (P.27)

Set "BRIGHTNESS ADJUST" in the manual settings menu to the "-" side.

"Adjusting Brightness" (P.29)

#### The color looks strange. (Too bluish, too reddish, etc.)

Set "WHITE BALANCE" in the manual settings menu to "MANUAL". Select from "FINE"/"CLOUD"/"HALOGEN" according to the light source. Select "MWB" and adjust accordingly.

"Setting White Balance" (P.30)

If the video was recorded with "x.v.Color" set to "ON", set the x.v.Color setting of the TV to on.

"x.v.Color" (P.101)

Set "EFFECT" to "OFF".

"EFFECT" (P.107)

### Other Problems

#### The slider and operation buttons do not work.

Touch the slider and buttons around the screen with your fingers. The slider and buttons do not function if you touch them with your fingernails or with gloves on.

The displays on the screen do not work even if you touch them.

#### The unit operates slowly when switching between video mode and still image mode, or when switching the power on or off.

It is recommended that you copy all videos and still images onto your computer, and erase the files from this unit. (If there are many recorded files on this unit, it takes time for the unit to respond.)

#### The image is grainy.

When digital zoom is used, the image becomes grainy as it is digitally enlarged.

#### The unit heats up.

This is not a malfunction. (This unit may become warm when used for a long time.)

#### The remote control does not work.

Replace the battery.

"Using the Remote Control (GZ-HM350/GZ-HM330)" (P.17)

Set "REMOTE" in the basic settings menu to "ON".

"REMOTE (GZ-HM350/GZ-HM330)" (P.121)

The remote control may not operate outdoors or in places exposed to strong light.

#### When connecting to the HDMI mini cable, the image or sound does not appear on the TV properly.

The image or sound may not appear on the TV properly depending on the TV connected. In such cases, perform the following operations. (1) Disconnect the HDMI mini cable and connect it again. (2) Turn off and on this unit again.

"Connecting via the HDMI Mini Connector" (P.46)

#### The language on the display changed.

It may occur when you connect this unit to a TV with different language setting using an HDMI mini cable.

"Operating in Conjunction with TV via HDMI" (P.46)

#### HDMI-CEC functions do not work properly, and the TV does not work in conjunction with this unit.

TVs may operate differently depending on the specifications, even if they are HDMI-CEC compliant. Therefore, the HDMI-CEC functions of this unit cannot be guaranteed to operate in combination with all the TVs. In such cases, set "HDMI CONTROL" to "OFF".

"HDMI CONTROL" (P.126)

#### Make a backup of important recorded data.

It is recommended to copy your important recorded data to a DVD or other recording media for storage. JVC will not be responsible for any lost data.

## Error Message?

### SET DATE/TIME!

Connect the AC adapter, charge the battery pack for more than 24 hours, then set the clock. (If the message still appears, the clock battery is exhausted. Consult your nearest JVC dealer.)

"Clock Setting" (P.15)

### COMMUNICATION ERROR

Reconnect the USB cable.

Turn off this unit and the devices connected to it, and turn them on again.

Reattach the battery pack.

### FORMAT ERROR!

Check the operating procedure, and perform once again.

"FORMAT BUILT-IN MEM. (GZ-HM350/GZ-HM330)" (P.129)

Turn off this unit, and turn it on again.

### DATA DELETION ERROR

Check the operating procedure, and perform once again.

"ERASE ALL DATA (GZ-HM350/GZ-HM330)" (P.130)

Turn off this unit, and turn it on again.

### MEMORY CARD ERROR!

Turn off this unit, and turn it on again.

Remove and re-insert the SD card after detaching the AC adapter and battery pack.

Remove any dirt from the SD card terminals.

If the above does not solve the problem, back up your files and execute "FORMAT SD CARD" in the media settings menu. (All data will be deleted.)

"FORMAT SD CARD" (P.129)

### NOT FORMATTED

Select "OK", then select "YES" on the "DO YOU WANT TO FORMAT?" screen.

### RECORDING FAILURE

Remove and re-insert the SD card.

"Inserting an SD Card (GZ-HM350/GZ-HM330)" (P.13)

Remove any dirt from the SD card terminals.

Insert the SD card before turning on the power.

Do not subject this unit to strong impact/vibrations.

Turn off this unit, and turn it on again.

### CANNOT TAKE MORE STILL IMAGES AT THE MOMENT

Stop video recording before taking still images. (If the SD card is removed and inserted during video recording, still images cannot be recorded.)

### PLAYBACK FAILED

Remove and re-insert the SD card.

"Inserting an SD Card (GZ-HM350/GZ-HM330)" (P.13)

Remove any dirt from the SD card terminals.

Insert the SD card before turning on the power.

Do not subject this unit to strong impact/vibrations.

### VIDEO MANAGEMENT FILE IS DAMAGED, RECOVERY IS REQUIRED TO RECORD/PLAYBACK, RECOVER?

Select "OK" to restore. (Videos that cannot be restored will not be displayed on the index screen, but you may be able to play them back using "PLAYBACK OTHER FILE" in the menu.)

"Playing a Video with Defective Management Information" (P.41)

### UNSUPPORTED FILE!

Use files recorded with this unit. (Files recorded with other devices may not be playable.)

### THIS FILE IS PROTECTED

Switch off the "PROTECT/CANCEL" function in the "EDIT" menu.

"Protecting Files" (P.52)

### INSUFFICIENT AVAILABLE SPACE

Delete files, or move files to a PC or other devices.

Replace the SD card with a new one.

### MAXIMUM QUANTITY RECORDING FOLDERS/ FILES HAS BEEN REACHED

(1) Move the files or folders to a PC or other device. (Back up your files.)

(2) Select "FILE + MANAGEMENT NO" in "FORMAT BUILT-IN MEM." or "FORMAT SD CARD" of the media settings menu. (All data on the built-in memory or SD card will be deleted.)

### SCENE QUANTITY EXCEEDED LIMIT

(1) Move the files or folders to a PC or other device. (Back up your files.)

(2) Select "FILE + MANAGEMENT NO" in "FORMAT BUILT-IN MEM." or "FORMAT SD CARD" of the media settings menu. (All data on the built-in memory or SD card will be deleted.)

### NUMBER OF FOLDERS OVERFLOW

(1) Move the files or folders to a PC or other device. (Back up your files.)

(2) Select "FILE + MANAGEMENT NO" in "FORMAT BUILT-IN MEM." or "FORMAT SD CARD" of the media settings menu. (All data on the built-in memory or SD card will be deleted.)

### FILE QUANTITY LIMIT EXCEEDED

(1) Move the files or folders to a PC or other device. (Back up your files.)

(2) Select "FILE + MANAGEMENT NO" in "FORMAT BUILT-IN MEM." or "FORMAT SD CARD" of the media settings menu. (All data on the built-in memory or SD card will be deleted.)

### PLAYLIST QUANTITY EXCEEDS LIMIT

Reduce the number of the playlist to 99 files or less. (Up to 99 playlists can be created.)

### CANCELLED BECAUSE PLAYLIST AMOUNT EXCEEDED MAXIMUM LIMIT

When creating a DVD, reduce the number of playlists to be saved.

Reduce the number of videos to add to the playlist to 999 files.

"Creating Playlists from the Recorded Videos" (P.63)

### PROCESSING CANCELLED DUE TO LIMITED SPACE FOR OPERATION

Reduce the number of videos to add to the playlist to 999 files.

"Creating Playlists from the Recorded Videos" (P.63)

### NO FILES

Change the setting in "REC MEDIA FOR VIDEO" or "REC MEDIA FOR IMAGE", and check that files are not recorded to the other media.

"REC MEDIA FOR VIDEO (GZ-HM350/GZ-HM330)" (P.127)

### INSERT DISC/CHANGE DISC

Open the tray of the BD/DVD writer, check and reset the BD/DVD, then close the tray.

Replace the disc in the BD/DVD writer.

### DVD-R DISC HAS ALREADY BEEN USED

Replace the disc with an unused one.

### RECORDING CANCELLED

Set "REC MEDIA FOR VIDEO" to "SD", then record to a SD card.

"REC MEDIA FOR VIDEO (GZ-HM350/GZ-HM330)" (P.127)

Turn off the unit, and turn it on again.

Protect the unit from vibration and shock.

### **CHECK LENS COVER (GZ-HM300)**

Appears for 5 seconds after power is turned on, if the lens cap is attached or when it is dark.

---

Perform regular maintenance of this unit to enable it to be used for a long time.

**CAUTION:**

- Be sure to detach the battery pack, AC adapter, and power plug before performing any maintenance.
- 

**Camcorder**

- Wipe this unit with a dry, soft cloth to remove any dirt.
- When it is extremely dirty, soak the cloth in a solution of neutral detergent, wipe the body with it, and then use a clean cloth to remove the detergent.

**CAUTION:**

- Do not use benzene or thinner. Doing so may cause damage to the unit.
  - When using a chemical cloth or cleaner, be sure to observe the warning labels and instructions of the product.
  - Do not leave the device in contact with rubber or plastic products for a long time.
- 

**Lens/LCD Monitor**

- Use a lens blower (commercially available) to remove any dust, and a cleaning cloth (commercially available) to wipe off any dirt.  
Mold may form if the lens is left dirty.

**Camera**

Item	Details
Power supply	Using AC adapter: DC 5.2 V Using battery pack: DC 3.6 V
Power consumption	GZ-HM350/GZ-HM330 2.7 W (when "LIGHT" is set to "OFF" and "LCD BACKLIGHT" is set to "STANDARD") 2.9 W (when "LIGHT" is set to "OFF" and "LCD BACKLIGHT" is set to "BRIGHTER") GZ-HM300 2.6 W (when "LCD BACKLIGHT" is set to "STANDARD") 2.8 W (when "LCD BACKLIGHT" is set to "BRIGHTER")
Dimensions (mm)	52 x 62 x 110 (W x H x D: excluding grip belt)
Mass	GZ-HM350/GZ-HM330 Approx. 220 g (camera only) Approx. 260 g (including supplied battery pack) GZ-HM300 Approx. 215 g (camera only) Approx. 255 g (including supplied battery pack)
Operating environment	Allowable operating temperature: 0°C to 40°C Allowable storage temperature: -20°C to 50°C Allowable operating humidity: 35 % to 80 %
Image pickup device	GZ-HM350/GZ-HM330 1/4" 3,320,000 pixels (progressive CMOS) GZ-HM300 1/5.8" 1,370,000 pixels (progressive CMOS)
Recording area (Video)	GZ-HM350/GZ-HM330 (16:9) 1,160,000 to 1,380,000 pixels (optical zoom) GZ-HM300 (16:9) 750,000 to 1,090,000 pixels (optical zoom)
Recording area (Still Image)	GZ-HM350/GZ-HM330 (4:3) 870,000 to 1,040,000 pixels (16:9) 1,160,000 to 1,380,000 pixels GZ-HM300 (4:3) 560,000 to 820,000 pixels (16:9) 750,000 to 1,090,000 pixels
Lens	GZ-HM350/GZ-HM330 F1.8-4.7, f= 3.0mm to 90.0mm (35mm conversion: 43.7mm to 1311mm) GZ-HM300 F1.8-3.5, f= 3.0mm to 60.0mm (35mm conversion: 46.4mm to 928mm)
Zoom (during video recording)	GZ-HM350/GZ-HM330 Optical zoom: Up to 30x Digital zoom: Up to 200x GZ-HM300 Optical zoom: Up to 20x Digital zoom: Up to 200x
Zoom (during still image recording)	GZ-HM350/GZ-HM330 Optical zoom: Up to 30x GZ-HM300 Optical zoom: Up to 20x
LCD monitor	2.7" wide, 12.3 megapixels, polysilicon color LCD
Recording media	GZ-HM350: Internal memory (32 GB) GZ-HM330: Internal memory (8 GB) SD/SDHC card (commercially available) "Types of Usable SD Card" (P.13)
Clock battery	Rechargeable battery

**Connectors**

Item	Details
HDMI	HDMI™ mini connector (V1.3 with x.v.Color™)
Component output	Y, Pb, Pr component output Y: 1.0 V (p-p), 75 Ω Pb/Pr: 0.7 V (p-p), 75 Ω
AV output	Video output: 1.0 V (p-p), 75 Ω Audio output: 300 mV (rms), 1 K Ω
USB	GZ-HM330 Mini USB type AB, USB 2.0 compliant GZ-HM300 Mini USB type B, USB 2.0 compliant

**Video**

Item	Details
Recording/Playback format	AVCHD standard, Video: AVC/H.264, Audio: Dolby Digital (2ch)
Extension	.MTS
Signal system	PAL standard
Image quality (Video)	UXP 1920 x 1080 pixels Average Approximate 24 Mbps XP 1920 x 1080 pixels Average Approximate 17 Mbps SP 1920 x 1080 pixels Average Approximate 12 Mbps EP 1920 x 1080 pixels Average Approximate 5 Mbps
Sound quality (Audio)	48 kHz, 256 kbps

**Still Image**

Item	Details
Format	JPEG standard
Extension	.JPG
Image size	1920 x 1080 1440 x 1080 640 x 480
Quality	FINE / STANDARD

**AC Adapter (AP-V30M)**

Item	Details
Power supply	AC 110 V to 240 V, 50 Hz/60 Hz
Output	DC 5.2 V, 1.8 A
Allowable operating temperature	0°C to 40°C (10°C to 35°C during charging)
Dimensions (mm)	50 x 29 x 100 (W x H x D: excluding cord and AC plug)
Mass	Approx. 112 g



**Battery Pack (BN-VG114E)**

Item	Details
Power voltage	3.6 V
Capacity	1400 mAh
Dimensions (mm)	31 x 21.5 x 43 (W x H x D)
Mass	Approx. 40 g

**Remote Control (RM-V760)**

Item	Details
Power supply	DC 3.0 V
Battery life	Approx. 1 year (depending on frequency of use)
Operating distance	within 5 m
Operating temperature	0°C to 40°C
Dimensions (mm)	32.5 x 15.6 x 68 (W x H x D)
Mass	16 g (including battery)

"Optional Accessories" (P.20)

**Memo:**

- Some features explained in this manual only apply to the specific model identified.
- The specifications and appearance of this product are subject to changes for further improvement without prior notice.

**JVC**