

JVC

CAMCORDER

Detailed User Guide

GZ-E305

GZ-E307

GZ-EX315

Everio



Table of Contents

Beginner's Guide	4
-------------------------------	----------

Useful Shooting Techniques

Holiday Season/Christmas	5
Wedding	6
Travel	8
Amusement Park	10

Getting Started

Verifying the Accessories	12
Charging the Battery Pack	14
Grip Adjustment	15
Using as a Hand Strap	15
Inserting an SD Card	15
Types of Usable SD Card	16
Using the Touch Screen	17
Adjusting the Touch Panel	17
Names of Buttons and Functions on the LCD Monitor	18
Clock Setting	20
Resetting the Clock	21
Changing the Display Language	22
Holding this Unit	22
Tripod Mounting	23
Using this Unit Overseas	23
Charging the Battery Pack Overseas	23
Setting the Clock to Local Time when Traveling	24
Setting Daylight Saving Time	24
Optional Accessories	25

Recording

Taking Videos in Auto Mode	26
Capturing Still Images During Video Recording	28
Taking Still Images in Auto Mode	29
Zooming	32
Manual Recording	32
Shooting According to Scene (Subject)	34
Adjusting Focus Manually	35
Adjusting Brightness	36
Setting Backlight Compensation	37
Setting White Balance	38
Taking Close-up Shots	39
Recording with Effects	40
Recording with Animation Effects (ANIMATION EFFECT)	41
Recording with Face Decorations (DECORATE FACE EFFECT)	43
Recording with Decorative Stamps (STAMP)	44
Recording with Personal Handwriting (HANDWRITING EFFECT)	45
Capturing Subjects Clearly (TOUCH PRIORITY AE/AF)	46
Capturing Smiles Automatically (SMILE SHOT)	47
Capturing Pets Automatically (PET SHOT)	48
Registering Human Face Personal Authentication Information	50
Setting SMILE%/NAME DISPLAY	52
Editing the Registered Face Information	53
Reducing Camera Shake	54
Marking the Video While Recording	55
Slow-motion (High-speed) Recording	55
Recording at Intervals (TIME-LAPSE RECORDING)	56
Recording Stop-Motion Videos (STOP-MOTION REC)	58
Recording Automatically by Sensing Movements (AUTO REC)	59
Taking Group Shots (Self-timer)	60
Recording Videos with Date and Time	62
Checking the Remaining Recording Time	63

Playback

Playing Back Videos	65
Normal Playback	67
MARKING PLAYBACK	69
DIGEST PLAYBACK	73
PLAYBACK PLAYLIST	74
PLAYBACK OTHER FILE	75
Playing Back Still Images	76
Slideshow Playback	78
Searching for a Specific Video/Still Image by Date	78
Connecting to and Viewing on TV	79
Connecting via the HDMI Mini Connector	80
Connecting via the AV Connector	81

Editing

Deleting Unwanted Files	82
Deleting the Currently Displayed File	82
Deleting Selected Files	82
Protecting Files	83
Protecting/Releasing Protection of the Currently Displayed File	83
Protecting/Releasing Protection of Selected Files	84
Capturing a Still Image in the Video During Playback	85
Capturing a Required Part in the Video (TRIMMING)	85
Creating Playlists from the Recorded Videos	86
Creating Playlists with Selected Files	86
Creating Playlists by Date	88
Editing Playlists	89
Deleting Playlists	90

Copying

Creating a Disc Using a Connected Blu-ray Recorder	91
Dubbing Files to a Disc by Connecting to a DVD Recorder ...	92
Dubbing Files to a VHS Tape by Connecting to a VCR	93
Copying to Windows PC (GZ-EX315)	94
Verifying System Requirements (Guideline)	94
Installing the Provided Software	95
Backing Up Files	96
Recording Videos to Discs	97
Backing Up Files Without Using Provided Software	99
List of Files and Folders	100
Copying to Windows PC (GZ-E307/GZ-E305)	101
Verifying System Requirements (Guideline)	101
Installing the Provided Software (Built-in)	102
Backing Up All Files	103
Organizing Files	104
Recording Videos to Discs	105
Backing Up Files Without Using Provided Software	107
List of Files and Folders	108
Copying to Mac Computer	109

Using Wi-Fi (GZ-EX315)

Wi-Fi Capabilities	110
Operating Environment	111
Precautions on Using Wi-Fi	111
Image Monitoring via Direct Connection (DIRECT MONITORING)	112
Image Monitoring via an Access Point at Home (INDOOR MONITORING)	115
Image Monitoring via the Internet (OUTDOOR MONITORING)	120
Sending Still Images via E-mail upon Detection of Face or Movement (DETECT/MAIL)	123
Record and Send Videos via E-mail (VIDEO MAIL)	124
Image Monitoring on TV (TV MONITORING)	126
EASY STORAGE	127
Recording the Location Information	128
Using the Pan Cradle (Sold Separately)	131
Changing the Settings	133

Setting the Password (DIRECT MONITORING/INDOOR MONITORING/OUTDOOR MONITORING)	136
Setting the Enforced Group Owner (DIRECT MONITORING)	137
Changing the HTTP Port (DIRECT MONITORING/INDOOR MONITORING/OUTDOOR MONITORING)	137
Setting the UPnP of this Camera (OUTDOOR MONITORING)	138
Obtaining a Dynamic DNS (DDNS) Account	138
Setting Dynamic DNS on this Camera (OUTDOOR MONITORING)	139
Setting the Sender's E-mail Address of the Camera	140
Registering the Recipient's E-mail Address of the Camera	142
Setting the Detection Method of this Camera (DETECT/MAIL SETTING)	144
Setting the Detection Interval of this Camera (DETECT/MAIL SETTING)	144
Setting Self Recording on this Camera (DETECT/MAIL SETTING)	145
Registering the Access Points of the Camera to Connect (ACCESS POINTS)	145
Setting the Password (DIRECT MONITORING)	151
Enabling the MAC Address Filter (TV MONITORING)	152
Registering the MAC Address (TV MONITORING)	152
Checking the MAC Address of this Camera	153
Protecting the Network Settings with a Password	153
Initializing the Wi-Fi Settings	154
Changing the Panning Speed	155
Using Smartphone Applications	156
Indications on the Screen	156
Using the Markings	157
Using the Game Score	158
Transferring Videos (AVCHD format)	160
Transferring Videos (iFrame format)	163
Transferring Still Images	165
Smartphone Application Settings	167
Using the Wi-Fi Function from a Web Browser	169
Indications on the Screen	169
Troubleshooting	172
Wi-Fi Specifications	176

Using Wi-Fi by Creating a QR Code (GZ-EX315)

DIRECT MONITORING	179
INDOOR MONITORING	183
OUTDOOR MONITORING	187
DETECT/MAIL	192
VIDEO MAIL	196
TV MONITORING	200

Settings Menu

Operating the Menu	204
Operating the Top Menu	204
Operating the Shortcut Menu	205
RECORD SETTING Menu (video)	206
SPECIAL RECORDING Menu (video)	210
RECORD SETTING Menu (still image)	211
SPECIAL RECORDING Menu (still image)	213
PLAYBACK SETTING Menu (video)	214
EDIT Menu (video)	215
PLAYBACK SETTING Menu (still image)	216
EDIT Menu (still image)	217
SETUP (video/still image)	218
CONNECTION SETTINGS (video/still image)	221
MEDIA SETTINGS (video/still image)	222
USB CONNECTION MENU	223

Names of Parts

Indications on the LCD monitor

Troubleshooting

When the unit is not working properly	230
Battery Pack	231
Recording	231
SD Card	232
Playback	232
Editing/Copying	233
Computer	234
Screen/Image	234
Other Problems	235
Error Message?	236

Maintenance

Specifications

Basic Way to Hold a Camcorder ~ Recording Stable Images ~



This is the standard way of shooting while standing up. Be sure to master this basic technique in order to achieve stable images.

■ [Getting Ready]

- 1 Open your feet to the width of your shoulders.
- 2 Keep the elbow of your right arm, which is holding the camcorder, close to your side.
- 3 Hold the LCD monitor with your left hand and adjust the angle accordingly.

Extending Your Hands to Shoot ~ High-Angle Shooting ~



Extend your hand when your subject is being hidden behind a crowd of people.

■ [Getting Ready]

- 1 Open your feet to the width of your shoulders.
- 2 Extend your right hand and hold the camcorder over your head.
- 3 Hold the LCD monitor with your left hand and adjust the angle accordingly.

Caution :

- Use this way of shooting only as a last resort as it is difficult to achieve stable images.
- Set to the wide angle as much as possible as the image will be prone to camera shake.
- Be considerate. Do not inconvenience the people around you.

Squatting and Shooting at Eye Level



Staying low is a common position to take when shooting small children. By recording from the eye level of the child, you can capture all his cute expressions clearly.

■ [Getting Ready]

- 1 Kneel down with your left knee while keeping your right foot on the ground.
- 2 Place the elbow of your right arm, which is holding the camcorder, on your right knee.
- 3 Hold the LCD monitor with your left hand and adjust the angle accordingly.

Panning

- Refer to the operating instructions found in the animation on the Detailed User Guide.

Use this method to shoot a wide angle of view.

■ [Getting Ready]

- 1 Shoot by rotating your body instead of moving your arms while keeping the basic way of holding a camcorder as stated above.
- 2 Stand facing the direction where the rotation will stop.
- 3 Twist your upper body to the direction where recording will start.
- 4 Press the start button and record for 2 seconds, then slowly twist back your body to face the front.
Record for another 2 seconds while facing the front, then press the stop button.
(The 90 degrees rotation should take about 5 seconds, giving the feeling of a slow motion.)

Introducing the Various Shooting Techniques!



■ “Holiday Season/Christmas” (☞ p. 5)

Record the happy Christmas celebration with your family!



■ “Wedding” (☞ p. 6)

Create an awesome wedding video for the bride and groom!



■ “Travel” (☞ p. 8)

Capture all the good times of your domestic or overseas trips!



■ “Amusement Park” (☞ p. 10)

Take more shots of the smiling faces of everyone in the family!

Holiday Season/Christmas

Record the happy Christmas celebration with your family!



Photo by 101st CAB, Wings of Destiny

Decorating the Tree and Preparing the Dinner

The decoration of tree and preparation of dinner are part of the joy of Christmas. Be sure to record these happy family times!

■ Decorating the tree



A tree is the most important thing to bring out the mood of Christmas. Simply the scene of all family members engaging in the decorating of a fir tree with various colorful ornaments is full of the feeling of happiness.

■ Preparing the Dinner



Photo by Manicosity

[Creative Commons Attribution-No Derivative Works 3.0](#)

Record the scenes as everyone helps to prepare the feast of the night. You can film the mother who is cooking, the children who are helping, and of course, the process of making a cake!

Recording the Christmas Party



Photo by InnerSpirit

[Creative Commons Attribution-No Derivative Works 3.0](#)

After all preparations, it is finally the Christmas party itself. Not only should you record the candle-blowing scene, but also the smiles of the family while being surrounded by good food, or even the father who is slightly drunk from champagne!

Finding the Presents



For children, the greatest joy of Christmas is receiving presents the next morning. Their expression of delight when finding a present next to their pillow is a recording opportunity not to be missed. Get ready to shoot before the children wake up!

Wedding

Create an awesome wedding video for the bride and groom!



Discussing and Planning Before the Event

Before the day of the wedding reception, it is important to discuss with the bride and groom about various details such as the order of the ceremony and whether there are any entertainment programs or change of clothes. By understanding the preferences of the bride and groom, you will be able to shoot more appropriately.

■ Finding out the route of entrance



The highlight of a wedding reception is the entrance of the bride and groom. Find out which door they will enter from and the route they will take from the person-in-charge of the wedding hall in advance. Set up the tripod at a place where you can follow the couple using zoom without having to move around.

■ Number of times and timing of clothes-changing

Find out the timing of any changing of clothes so as to capture the scene well when the bride and groom enter again.

You can also make use the time while the bride and groom are changing to record comments of well wishes from the guests.

Finding the Right Angle to Capture Both Bride and Groom

■ Composing the picture with the groom in front and the guests at the back



The main characters of a wedding are of course the bride and groom. Record their expressions clearly during the toast, speech, entertainment programs, and other scenes. Another recommendation is to capture the face shots of the guests, then pan towards the groom. Picture composition containing the crowd of guests only lacks fun, so be sure to pay attention to the shooting angle and size.

Recording the Expressions and Comments of Guests

■ Setting the shot from eye level to chest level



You can record comments from the guest by going around asking, "Please say a few words for the bride and groom". This can be done at the guests' waiting room, when the bride and groom are changing, or during the entertainment programs.

Advanced Operation with Two Camcorders

If video-editing is to be done, record using two camcorders so that a video with varying scenes can be created. You can try asking a close friend who has a camcorder at home. Set the borrowed camcorder on a tripod to focus on taking close-up shots of the bride and groom. In this way, the other camcorder can be moved around to record other scenes, enabling an interesting video with changing scenes to be created through editing and compilation. As most people own at least a digital camera nowadays, even if you are really unable to find an extra camcorder, inserting still pictures to the video at various points is also a good way to add variety. Do give it a try!

■ <Camcorder 1> Closing up on the bride and groom all the time



■ <Camcorder 2> Recording the congratulatory messages from friends at the same time



Travel

Capture all the good times of your domestic or overseas trips!



Bringing the Necessary Equipment

The necessary things to bring on a trip depends on your traveling purpose and the destination. For overseas trips in particular, you have to think about what to bring in accordance to the local conditions. Here are some suggestions for your consideration.

■ Camcorder

Think about how many hours of shooting you will usually perform in a day. Be sure to prepare enough recording medium especially for long overseas trips.

If you are recording in SD cards, get ready the sufficient number of cards, including some for backup.

■ Battery Pack

Prepare a battery pack that is ready for three times the expected recording time in a day. For example, if you plan to record for 2 hours a day, prepare a battery pack that is ready for 6 hours (actual recording time). For a day trip, you can prepare a battery with low capacity but for a long trip, do prepare a few batteries with high capacities.

■ AC Adapter

The JVC AC adapter supports voltages from 110 V to 240 V, and hence can be used anywhere in the world.

Bring along the adapter if you are traveling for a long time. Charge the battery pack while sleeping so that you can record with full battery power the next day.

■ Power Plug Adapter



The shape of the power plug varies according to countries. Be sure to check the shape of the power plug beforehand, and bring the appropriate power plug adapter.

“Charging the Battery Pack Overseas” (p. 23)

■ Battery Charger



Recording cannot be performed when an AC adapter is connected to the camcorder for battery charging.

You can bring an additional battery charger to charge battery packs if you plan to use the camcorder for recording at night. You can also charge multiple battery packs by using both the battery charger and this camcorder at the same time.

■ Tripod



A tripod is an essential item to take stable images. Select an appropriate tripod in accordance to your purpose and style of traveling, such as a compact one to be used on a table or one that is at least 1 m tall.

Recording the Excitement Before Departure

It may be a little abrupt to start your travel video at the destination suddenly. Record also the preparations prior to departure if it is a family trip, or the time when everyone is gathered at the meeting place if you are traveling with your friends. For overseas trips, taking a shot of the signs and displays at the airport of the flight you are taking may be useful for future reference.



Using Pan at the Places of Interest

Tourists spots with beautiful scenery or historical sites are places that you would certainly want to record. To capture the magnificence of a scene which cannot be fitted into a single frame, try the panning technique. Refer to “Shooting Tips” found in the “Beginner’s Guide” on this website on how to use panning effectively. In addition, you may also like to take a shot of the signs or monuments that can often be found at the tourist spots.



Showing Everyone Having a Good Time

When taking a video, it is rather dull to shoot only the scenery or historical sites. Talk about your feelings while recording the breath-taking scenery of an attraction so that it will be an interesting scene to view later.

Amusement Park

Take more shots of the smiling faces of everyone in the family!



Taking Videos or Still Images According to the Attraction

You may choose to take videos all the time. However, you may want to take some still images too.

The following section explains the scenarios suitable for taking videos or still images.

■ Scenarios suitable for taking videos



Scenarios with changes in body movement are suitable for taking videos. This includes situations where there are rapid changes in facial expressions or voices of surprise and delight.

*Some amusement parks do not allow passengers to perform any recording. Be sure to check beforehand.

[Examples]

- Merry-go-round, go kart, coffee cup, etc.

■ Scenarios suitable for taking still images (photos)



Scenarios with little movement of the subject are suitable for taking still images.

Try to take the still images from an angle such that the surroundings can be seen clearly.

[Examples]

- Carousel, ferris wheel, fun bicycle rides, etc.

Inducing Responses by Calling Out



Videos with no waving of hands nor laughter are not only dull when you view them later, but also put the capability of the audio-recording function of the camcorder to a waste. When recording, induce more reactions by enthusiastically waving your hands or shouting out "Is it fun?" and the like.

Capturing the Best Moment in a Video as a Still Image

Shots with the eyes closed are often taken by accident. To reduce such mistakes, make use of the function to capture still images from videos. As videos are actually continuous recording of 50 still images within 1 minute, using this function allows you to select the best moment and save it as a still image.

"Capturing a Still Image in the Video During Playback" (p. 85)



Photo by just that good guy jim

[Creative Commons Attribution-No Derivative Works 3.0](#)

Video Playback in Progress



[Creative Commons Attribution-No Derivative Works 3.0](#)



Photo by just that good guy jim

[Creative Commons Attribution-No Derivative Works 3.0](#)

Video Playback in Progress

Advanced Operation with Backlight Compensation

When the subject's face is in backlight or when the expression cannot be seen clearly, the Intelligent Auto function of this unit automatically increases

its brightness for recording. If Intelligent Auto fails to function as expected or if the brightness correction is insufficient, you can increase the brightness by using backlight compensation in the Manual mode.

“Setting Details” (p. 37)

■ <Without backlight compensation>









■ <With backlight compensation>

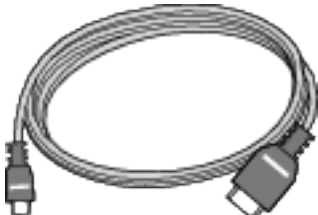
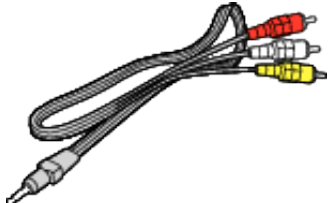

Verifying the Accessories

If any of the items are missing or defective, consult your JVC dealer or the nearest JVC service center.

Illustration	Description
	<p>AC Adapter AC-V10M</p> <ul style="list-style-type: none"> Connects to this unit to charge the battery pack. It can also be used when recording or playing back videos indoors.
	<p>Power Cord</p> <ul style="list-style-type: none"> Connect the power cord to the AC adapter.
	<p>Battery Pack BN-VG108E (GZ-E305) BN-VG114E (GZ-EX315/GZ-E307)</p> <ul style="list-style-type: none"> Attaches to this unit to supply power.
	<p>HDMI Mini Cable (GZ-E307)</p> <ul style="list-style-type: none"> Connects this unit to a TV to play back recorded images on the TV in a better quality.
	<p>AV Cable QAM1322-001</p> <ul style="list-style-type: none"> Connects this unit to a TV to play back recorded images on the TV. Consult your nearest JVC service center if you need to purchase the AV cable.
	<p>USB Cable (Type A - Mini Type B)</p> <ul style="list-style-type: none"> Connects this unit to a computer.
	<p>CD-ROM (GZ-EX315)</p> <ul style="list-style-type: none"> For installing the provided software on a computer.
	<p>Basic User Guide</p> <ul style="list-style-type: none"> Read well and keep in a safe place where it can be accessed easily when necessary.

Memo :

- SD cards are sold separately.
- "Types of Usable SD Card" (p. 16)
- When using the AC adapter overseas, please prepare a commercially available converter plug for the country or region of visit.

“Charging the Battery Pack Overseas” (p. 23)

Charging the Battery Pack

Charge the battery pack immediately after purchase and when the remaining battery power is low.

The battery pack is not charged at the time of purchase.

1 Attach the battery pack.

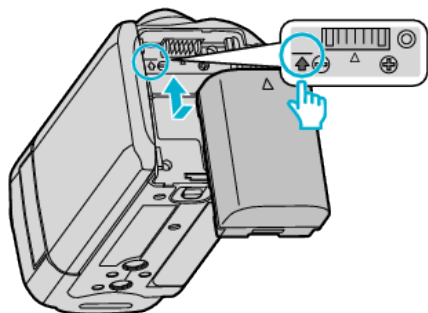

- Align the top of the battery with the mark on this unit, and slide in until the battery clicks into place.

2 Connect the AC adapter to the DC connector.

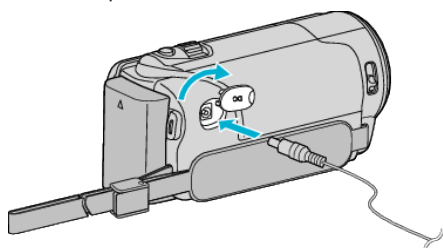

3 Plug in the power.

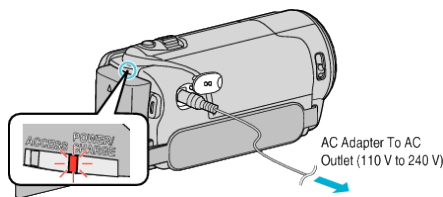

- The charging lamp blinks when charging is in progress. It goes out when charging is finished.

Warning

- Make sure not to insert the battery pack in the wrong direction. It may cause damage to the unit and battery pack.

Caution :



Be sure to use JVC battery packs.

- If you use any other battery packs besides JVC battery packs, safety and performance cannot be guaranteed.
- Charging Time:
Approx. 2 h 20 m (using supplied battery pack, BN-VG108E)
Approx. 2 h 30 m (using supplied battery pack, BN-VG114E)
- The charging time is when the unit is used at 25°C. If the battery pack is charged outside the room temperature range of 10°C to 35°C, charging may take a longer time or it may not start. CHARGE lamp blinks 2 times in a slow cycle for notification if the battery charge does not start. Also, please note that the recordable and playable time may also be shortened under some usage conditions such as at low temperature.
- If malfunctions (overvoltage, etc) occur, or if any battery manufactured other than JVC is attempted for battery charge, charging stops. In these cases, CHARGE lamp blinks quickly for notification.

Be sure to use the supplied AC adapter.

- If you use any other AC adapters besides the supplied AC adapter, malfunctions may occur.
- You can record or play back videos while the AC adapter is connected. (Battery charging cannot be performed during recording or playback.) Remove the battery when the unit is to be used for a long time. Performance of the battery may drop if it is left attached to the unit.

Rechargeable Batteries :

- When using the battery in a low temperature environment (10°C or below), the operating time may be shortened, or it may not function properly. When using this unit outdoors in the winter weather, warm the battery, such as by placing it in the pocket, before attaching it. (Keep away from direct contact with a warm pack.)
- Do not expose the battery to excessive heat, such as direct sunlight or fire.
- After removing the battery, store it in a dry place between 15°C to 25°C.
- Keep a 30 % battery level () if the battery pack is not to be used for a long period of time. In addition, fully charge and then fully discharge the battery pack every 6 months, then continue to store it at a 30 % battery level ().

Memo :

- You can connect this unit to the AC adapter to record for long hours indoors. (Battery charging begins when the LCD monitor is closed.)

Detaching the Battery Pack

To detach the battery pack, perform the above steps in reverse order.

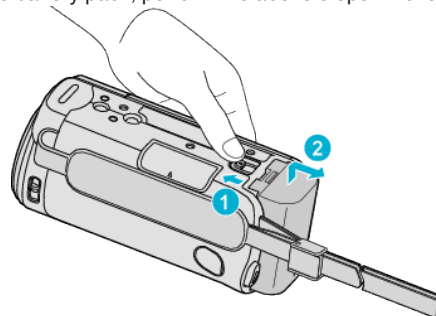

Slide the battery release lever to detach the battery from this unit.

Approximate Battery Charging Time (Using AC Adapter)

Battery Pack	Charging time
BN-VG108E (Supplied: GZ-E305)	2 h 20 m
BN-VG114E (Supplied: GZ-EX315/GZ-E307)	2 h 30 m
BN-VG121E	3 h 30 m
BN-VG138E	6 h 10 m

- When the battery life is reached, the recording time becomes shorter even if the battery pack is fully charged. (Replace the battery pack with a new one.)

* The charging time is when the unit is used at 25°C. If the battery pack is charged outside the room temperature range of 10°C to 35°C, charging may take a longer time or it may not start. The recordable and playable time may also be shortened under some usage conditions such as at low temperature. "Approximate Recording Time (Using Battery)" ( p. 64)

Grip Adjustment

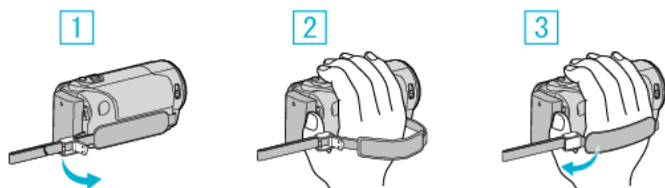

- 1 Open the lever on the strap lock
- 2 Adjust the length of the belt
- 3 Close the lever

Caution :

- Be sure to fasten the grip belt properly.
If the belt is loose, this unit may drop and result in injuries or damages.

Using as a Hand Strap

Adjust the length of the belt and loop it around your wrist.

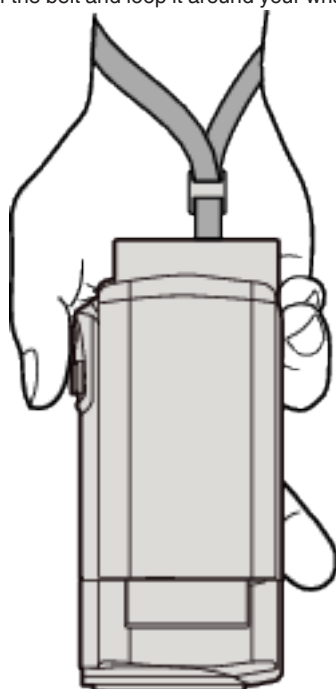

Inserting an SD Card

Insert a commercially available SD card before recording.
“Types of Usable SD Card” (☞ p. 16)
“Approximate Video Recording Time” (☞ p. 64)

- 1 Close the LCD monitor.

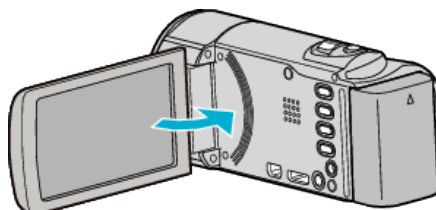

- 2 Open the cover.

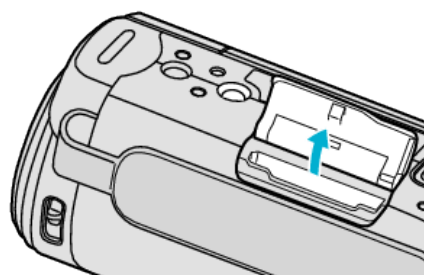

- 3 Insert an SD card.

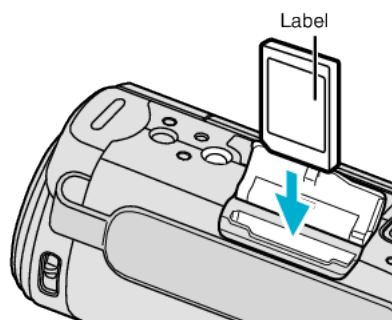

- Insert with the label facing outward.

Warning

- Make sure not to insert the SD card in the wrong direction. It may cause damage to the unit and SD card.
- Turn off the power of this unit before inserting or removing an SD card.
- Do not touch the metal contact area when inserting the SD card.

Memo :

- Both videos and still images can be recorded on one SD card. It is recommended to confirm the video operation of the SD card before usage.
- To use SD cards that have been used on other devices, it is necessary to format (initialize) the SD card using “FORMAT SD CARD” from media settings.

“FORMAT SD CARD” (☞ p. 222)

Removing the Card

Push the SD card inward once, then pull it out straight.

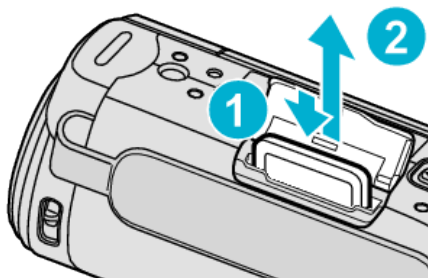

Types of Usable SD Card

The following SD cards can be used on this unit. Operations are confirmed on the SD cards from the following manufacturers.

- Panasonic
- TOSHIBA
- SanDisk

SD Card



- This unit supports 256 MB to 2 GB SD cards.
- Use a Class 4 or higher compatible SD card (2 GB) for video recording.

SDHC Card



- Use a Class 4 or higher compatible SDHC card (4 GB to 32 GB) for video recording.

SDXC Card



- Use a Class 4 or higher compatible SDXC card (Max. 128 GB) for video recording.

Memo :

- Using SD cards (including SDHC/SDXC cards) other than those specified above may result in recording failure or data loss.
- This unit is not guaranteed to operate with all SD cards. Some SD cards may not work due to specification changes, etc.
- To record videos with "VIDEO QUALITY" set to "UXP", use of a Class 6 or higher compliant SDHC/SDXC card is recommended.
- To select "iFrame" in the video recording format, use a Class 6 or higher compliant SDHC/SDXC card. (GZ-EX315)
- Class 4 and Class 6 are guaranteed to have a minimum transfer rate of 4 MB/s and 6 MB/s respectively during reading or writing of data.
- You can also use a Class 10 compliant SDHC/SDXC card.
- Both videos and still images can be recorded on one SD card. It is recommended to confirm the video operation of the SD card before usage.
- To protect the data, do not touch the terminals of the SD card.
- UHS-I SDHC/SDXC cards can be used in the same manner as standard SDHC/SDXC cards.
UHS Speed Class is not supported.

When your computer cannot recognize the SDXC card

Confirm and update the OS of your computer.

Windows XP	<ul style="list-style-type: none"> • Make sure that the operating system version is SP2 or higher. • Download and install the updating program (KB955704) from the following URL. http://www.microsoft.com/downloads/details.aspx?FamilyID=1cbe3906-ddd1-4ca2-b727-c2dff5e30f61&displaylang=en
Windows Vista	<ul style="list-style-type: none"> • Make sure that the operating system version is SP1 or higher. • Download and install the updating program (KB975823) from the following URL. 32 bit version http://www.microsoft.com/downloads/en/details.aspx?FamilyID=2d1abe01-0942-4f8a-abb2-2ad529de00a1 64 bit version http://www.microsoft.com/downloads/en/details.aspx?FamilyID=7d54c53f-017c-4ea5-ae08-34c3452ba315
Windows 7	<p>Download and install the updating program (KB976422) from the following URL.</p> <p>32 bit version http://www.microsoft.com/downloads/en/details.aspx?FamilyID=3ee91fc2-a9bc-4ee1-aca3-2a9aff5915ea 64 bit version http://www.microsoft.com/downloads/en/details.aspx?FamilyID=73f766dd-7127-4445-b860-47084587155f</p>
Mac OS X 10.4 Tiger / Mac OS X 10.5 Leopard	Not compatible.
Mac OS X 10.6 Snow Leopard	Update the OS version to 10.6.5 or later.

Using the Touch Screen

Icon operation buttons, thumbnails, and menu items are displayed on the touch screen according to the mode in use.

- There are two ways to operate the touch screen, namely “tap” and “drag”. The following are some examples.

*The following is a screen of the model with Wi-Fi functions.

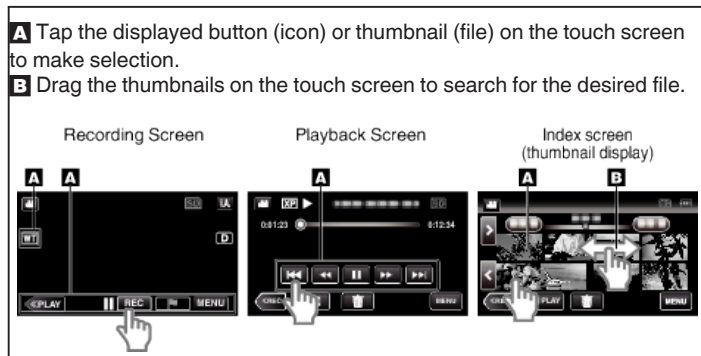

Memo :

- The touch screen of this unit is pressure-sensitive. When the touch screen does not respond smoothly, apply slightly more force to your fingertip.
- Tap the buttons (icons) on the touch screen accurately. The buttons may not respond if they are not tapped on the right area.
- Do not press or rub with excessive force.
- Do not operate the touch screen using an object with a sharp tip.
- Pressing two or more places at a time may cause a malfunction.
- Perform “TOUCH SCREEN ADJUST” if the reactive area of the screen is misaligned with the touched area. (Adjust by lightly tapping with a corner of an SD card, etc. Do not press with an object with a sharp tip or do not press hard.)

“Adjusting the Touch Panel” (p. 17)

Adjusting the Touch Panel

Adjusts the response position of the buttons on the touch screen.

*The following is a screen of the model with Wi-Fi functions.

- 1 Tap “MENU”.

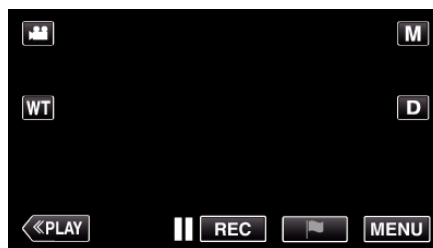

- 2 Tap “SETUP”.

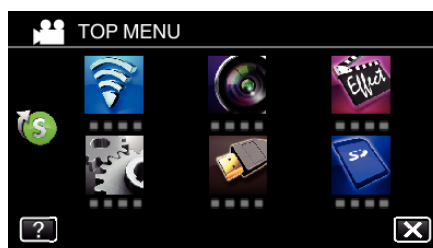

- 3 Tap “TOUCH SCREEN ADJUST”.

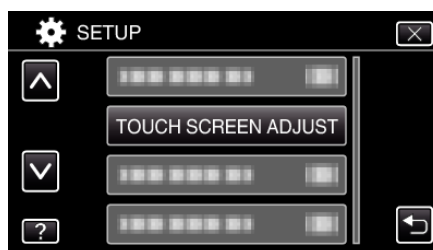

- The touch screen adjustment screen appears.

- 4 Tap “+”. (3 times in total)



- Keep tapping “+” as its position changes with every tap.
- If areas other than the “+” mark are tapped, errors will occur. Make sure to tap the “+” mark.

- 5 Tap “+” again to confirm the adjusted positions. (3 times in total)



- Keep tapping “+” as its position changes with every tap.

- 6 Tap “OK”.

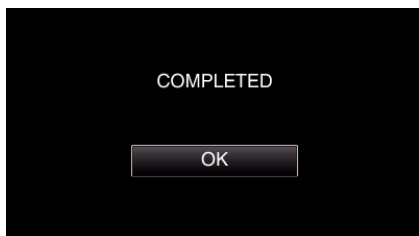

- Setting ends and returns to the menu screen.

Caution :

- Do not tap areas other than the “+” mark during touch screen adjustment (steps 4 - 5). Doing so may cause the touch screen to malfunction.

Memo :

- Adjust by lightly tapping with a corner of an SD card, etc.
- Do not press with an object with a sharp tip or do not press hard.

Names of Buttons and Functions on the LCD Monitor

The following screens are displayed during the video and still image modes, and operate as the touch screens.

Recording Screen (Video/Still Image)

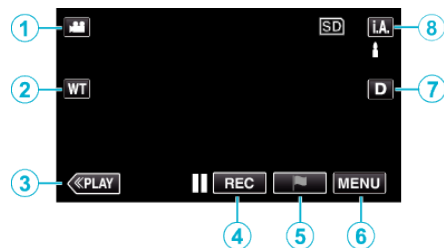

- 1** (Video/Still Image) Mode Button
 - Switches between video and still image modes.
- 2** Zoom Button
 - “Zooming” (☞ p. 32)
- 3** Playback Mode Button
 - Switches to the playback mode.
- 4** Recording Start/Stop Button
 - **REC**: Video Recording Start Button
 - **REC**: Video Recording Stop Button
 - : Still Image Recording Button
- 5** Mark Button (for video only)
 - By tapping the icon while recording is in progress, you can mark a particular scene to make it easier to find it.
 - “Marking the Video While Recording” (☞ p. 55)
- 6** Menu Button
 - “Operating the Menu” (☞ p. 204)
- 7** Display Button
 - Switches the display between full (**D?**) and simple (**D**) with every tap of the button.
 - Simple display: Some displays disappear after approximately 3 seconds.
 - Full display: Displays everything. The display button changes from **D** to **D?**.
 - When the power is turned off, simple display (**D**) will be set.
- 8** Recording Mode Button
 - Switches the recording mode between **i.A.** Intelligent Auto and Manual.

Playback Screen (Video)

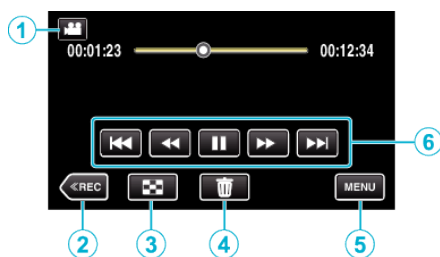

- Operations buttons on the touch screen disappear if the unit is not operated for about 5 seconds. Tap on the screen to display the operation buttons again.

- 1** (Video/Still Image) Mode Button
 - Switches between video and still image modes.
- 2** Recording Mode Button
 - Switches to the recording mode.
- 3** Index Screen (Thumbnail Display) Button
 - “Operation Buttons for Video Playback” (☞ p. 67)
- 4** Delete Button
 - “Deleting the Currently Displayed File” (☞ p. 82)
- 5** Menu Button
 - “Operating the Menu” (☞ p. 204)
- 6** Operation Buttons
 - “Operation Buttons for Video Playback” (☞ p. 67)

Playback Screen (Still Image)

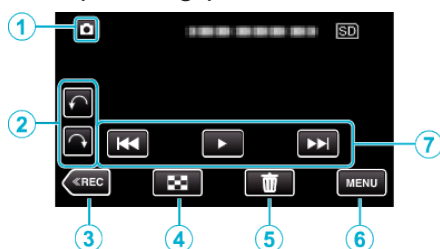

- Operations buttons on the touch screen disappear if the unit is not operated for about 5 seconds. Tap on the screen to display the operation buttons again.

- 1** (Video/Still Image) Mode Button
 - Switches between video and still image modes.
- 2** Rotate Button
 - Rotates a still image 90°. (Clockwise/Counterclockwise)
- 3** Recording Mode Button
 - Switches to the recording mode.
- 4** Index Screen (Thumbnail Display) Button
 - “Operation Buttons for Still Image Playback” (☞ p. 77)
- 5** Delete Button
 - “Deleting the Currently Displayed File” (☞ p. 82)
- 6** Menu Button
 - “Operating the Menu” (☞ p. 204)
- 7** Operation Buttons
 - “Operation Buttons for Still Image Playback” (☞ p. 77)

Index Screen (Thumbnail Display) Display

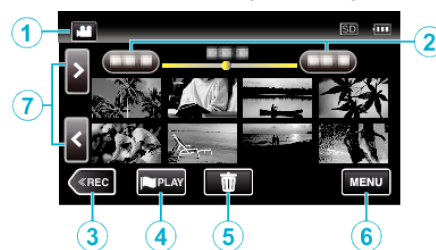

- 1** (Video/Still Image) Mode Button
 - Switches between video and still image modes.
- 2** Date Button
 - “Operation Buttons for Video Playback” (☞ p. 67)
 - “Operation Buttons for Still Image Playback” (☞ p. 77)
- 3** Recording Mode Button
 - Switches to the recording mode.
- 4** Mark Playback button (video only)
 - “MARKING PLAYBACK” (☞ p. 69)
- 5** Delete Button
 - “Deleting Selected Files” (☞ p. 82)
- 6** Menu Button
 - “Operating the Menu” (☞ p. 204)
- 7** Page Forward/Back Button
 - “Operation Buttons for Video Playback” (☞ p. 67)
 - “Operation Buttons for Still Image Playback” (☞ p. 77)

Menu screen (recording mode)

*The following is a screen of the model with Wi-Fi functions.

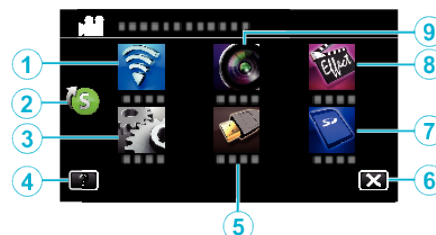

- 1** Wi-Fi menu (GZ-EX315 only)
 - “Wi-Fi Capabilities” (☞ p. 110)
- 2** Shortcut Menu
 - “Operating the Shortcut Menu” (☞ p. 205)
- 3** SETUP Menu
 - “SETUP (video/still image)” (☞ p. 218)
- 4** Help Button
 - Tap the ? (help) button and item to display descriptions.
- 5** CONNECTION SETTINGS Menu
 - “CONNECTION SETTINGS (video/still image)” (☞ p. 221)
- 6** Close Button
 - Exit the menu.
- 7** MEDIA SETTINGS Menu
 - “MEDIA SETTINGS (video/still image)” (☞ p. 222)
- 8** SPECIAL RECORDING Menu
 - “SPECIAL RECORDING Menu (video)” (☞ p. 210)
- 9** RECORD SETTING Menu
 - “RECORD SETTING Menu (video)” (☞ p. 206)

Menu screen (playback mode)

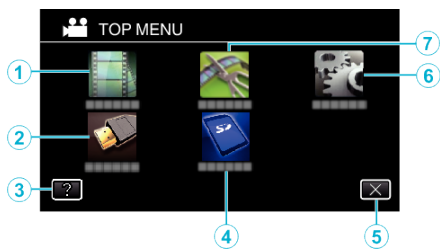

- 1 **PLAYBACK SETTING Menu**
 "PLAYBACK SETTING Menu (video)" (p. 214)
 "PLAYBACK SETTING Menu (still image)" (p. 216)
- 2 **CONNECTION SETTINGS Menu**
 "CONNECTION SETTINGS (video/still image)" (p. 221)
- 3 **Help Button**
 Tap the ? (help) button and item to display descriptions.
- 4 **MEDIA SETTINGS Menu**
 "MEDIA SETTINGS (video/still image)" (p. 222)
- 5 **Close Button**
 Exit the menu.
- 6 **SETUP Menu**
 "SETUP (video/still image)" (p. 218)
- 7 **EDIT Menu**
 "EDIT Menu (video)" (p. 215)
 "EDIT Menu (still image)" (p. 217)

Clock Setting

The "SET DATE/TIME!" screen appears when you turn on this unit for the first time after purchase, when it has not been used for a long time, or when the clock is not set yet.

Set the clock before recording.

*The following is a screen of the model with Wi-Fi functions.

- 1 Open the LCD monitor.

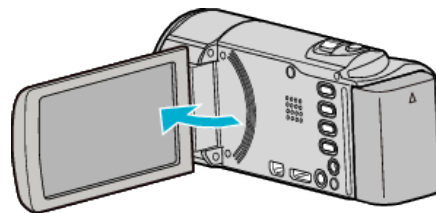

- The unit turns on.
- When the LCD monitor is closed, the unit turns off.

- 2 Tap "YES" when "SET DATE/TIME!" is displayed.



- 3 Set the date and time.

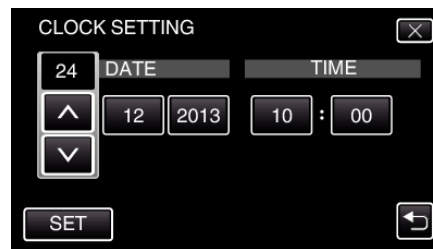

- When the day, month, year, hour, or minute item is tapped, "∧" and "∨" will be displayed.
- Tap ∧ or ∨ to adjust the day, month, year, hour, and minute.

- 4 After setting the date and time, tap "SET".

- 5 Select the region where you live and tap "SAVE".

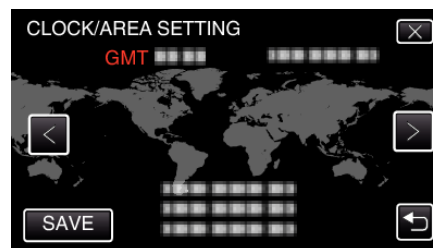

- Time difference between the selected city and the GMT (Greenwich Mean Time) is displayed.
- Tap < or > to select the city name.

Memo :

- The clock can be reset again later.
 "Resetting the Clock" (p. 21)
- When using this unit overseas, you can set it to the local time for recording.
 "Setting the Clock to Local Time when Traveling" (p. 24)
- "SET DATE/TIME!" is displayed when you turn on this unit after it has not been used for a prolonged period.
 Connect the AC adapter for more than 24 hours to charge the internal clock battery of this unit before setting the clock.

Resetting the Clock

Set the clock with "CLOCK ADJUST" from the menu.

*The following is a screen of the model with Wi-Fi functions.

1 Tap "MENU".

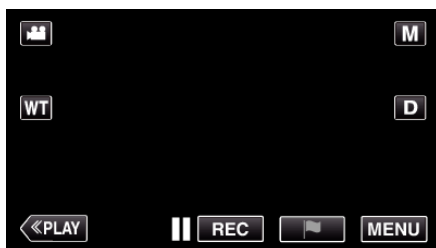

2 Tap "SETUP".

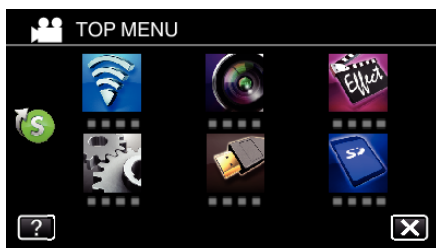

3 Tap "CLOCK ADJUST".

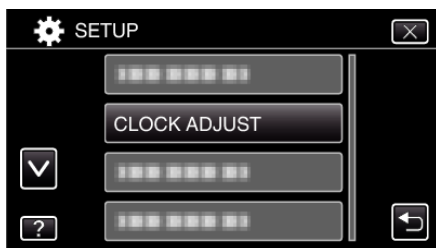

- Tap ^ or v to scroll the screen.

4 Tap "CLOCK SETTING".

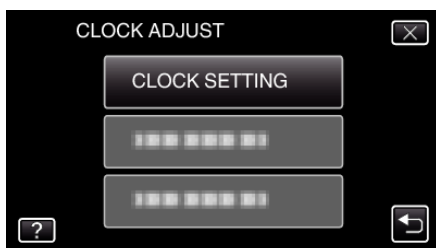

5 Set the date and time.

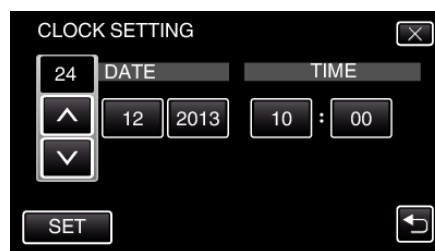

- When the day, month, year, hour, or minute item is tapped, " ^ " and " v " will be displayed.
- Tap ^ or v to adjust the day, month, year, hour, and minute.

6 After setting the date and time, tap "SET".

7 Select the region where you live and tap "SAVE".

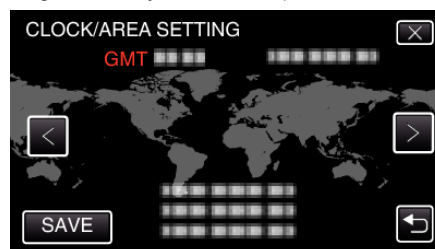

- Time difference between the selected city and the GMT (Greenwich Mean Time) is displayed.
- Tap < or > to select the city name.

Changing the Display Language

The language on the display can be changed.
*The following is a screen of the model with Wi-Fi functions.

1 Tap "MENU".



2 Tap "SETUP".

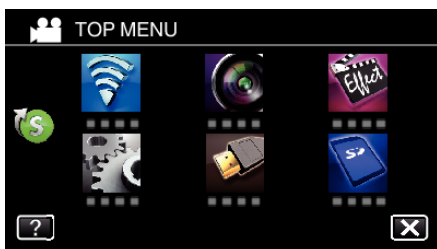

3 Tap "LANGUAGE".

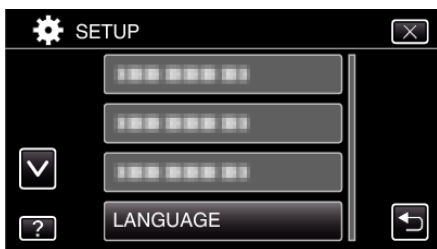

- Tap ^ or v to scroll the screen.

4 Tap to the desired language.



- Tap ^ or v to scroll the screen.

Holding this Unit

When holding this unit, keep your elbows close to your sides to prevent camera shake.



- Hold the LCD monitor with your left hand and adjust the angle accordingly. Holding the LCD monitor with your left hand helps to stabilize the camera for recording.

Caution :

- Be careful not to drop this unit during transportation.
- Guardians should pay close attention when this unit is being used by children.

Memo :

- If camera shake is excessive, use the image stabilizer. "Reducing Camera Shake" (p. 54)

Tripod Mounting

This unit can be mounted on a tripod (or monopod). This is useful for preventing camera shake and recording from the same position.

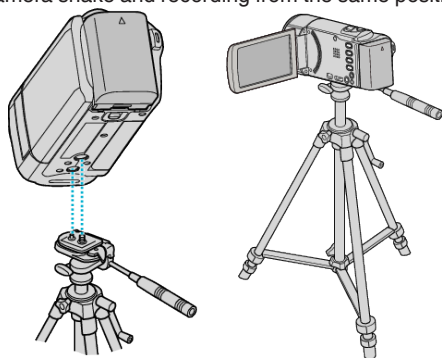

- To prevent this unit from falling off, check the tripod mounting screw holes and positioning holes on the unit carefully before mounting, and turn the screws until they are fastened firmly.

Caution :

- To prevent injuries or damages which may result if this unit falls off, read the instruction manual of the tripod (or monopod) to be used and make sure that it is securely attached.

Memo :

- It is recommended to use a tripod or monopod when recording in conditions prone to camera shake (such as in dark places or when zoomed to the telephoto end).
- Set the image stabilizer to  (OFF) when using a tripod for recording.

“Reducing Camera Shake” (p. 54)

Using this Unit Overseas

The shape of the power outlet varies according to countries and regions. To charge the battery pack, you need a converter plug that matches the shape of the outlet.

“Charging the Battery Pack Overseas” (p. 23)

Change the date and time display to the local time by selecting your travel destination in “AREA SETTING” of “CLOCK ADJUST”.





“Setting the Clock to Local Time when Traveling” (p. 24)

When “ON” is selected in “DST SETTING” of “CLOCK ADJUST”, the time is set 1 hour ahead.

“Setting Daylight Saving Time” (p. 24)

Charging the Battery Pack Overseas

The shape of the power outlet varies according to countries and regions. To charge the battery pack, you need a converter plug that matches the shape of the outlet.

A	B	BF	C	O
				

North America	Europe	Oceania	Middle East
United States A	Iceland C	Australia O	Israel C
Canada A	Ireland C	Guam A	Iran C
Mexico A	United Kingdom B, BF	Tahiti C	Kuwait B, C
	Italy C	Tonga O	Jordan B, BF
Asia	Austria C	New Zealand O	
Japan A	Netherlands C	Fiji O	Africa
India B, C, BF	Canary Islands C		Algeria A, B, BF, C
Indonesia C	Greece C	Latin	Egypt B, BF, C
Singapore B, BF	Switzerland C	Argentina O	Guinea C
Sri Lanka B, C, BF	Sweden C	Colombia A	Kenya B, C
Thailand A, BF, C	Spain A, C	Jamaica A	Zambia B, BF
South Korea A, C	Denmark C	Chile B, C	Tanzania B, BF
China A, B, BF, C, O	Germany C	Haiti A	Republic of South Africa B, C, BF
Nepal C	Norway C	Panama A	Mozambique C
Pakistan B, C	Hungary C	Bahamas A	Morocco C
Bangladesh C	Finland C	Puerto Rico A	
Philippines A, BF, O	France C	Brazil A, C	
Vietnam A, C	Belgium C	Venezuela A	
Hong Kong Special Administrative Region B, BF	Poland B, C	Peru A, C	
Macau Special Administrative Region B, C	Portugal B, C		
	Romania C		
Malaysia B, BF, C			

Setting the Clock to Local Time when Traveling

Change the date and time display to the local time by selecting your travel destination in "AREA SETTING" of "CLOCK ADJUST".

Restore the region settings after you returned from the trip.

*The following is a screen of the model with Wi-Fi functions.

1 Tap "MENU".



2 Tap "SETUP".

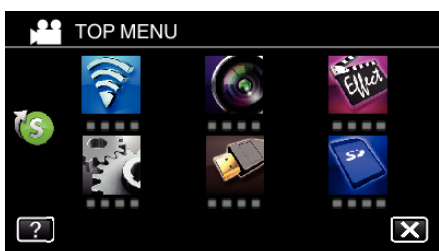

3 Tap "CLOCK ADJUST".



- Tap ^ or v to scroll the screen.

4 Tap "AREA SETTING".

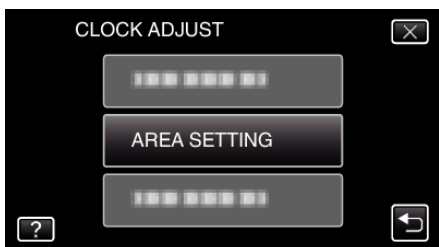

5 Select the area you are traveling to and tap "SAVE".



- Time difference between the selected city and the GMT (Greenwich Mean Time) is displayed.
- Tap < or > to select the city name.

Memo : _____
 • Setting "AREA SETTING" changes the clock time such that time difference is accounted for.
 After returning to your country, re-select the region that was set initially to restore the original clock settings.

Setting Daylight Saving Time

When "ON" is selected in "DST SETTING" of "CLOCK ADJUST", the time is set 1 hour ahead.

*The following is a screen of the model with Wi-Fi functions.

1 Tap "MENU".



2 Tap "SETUP".

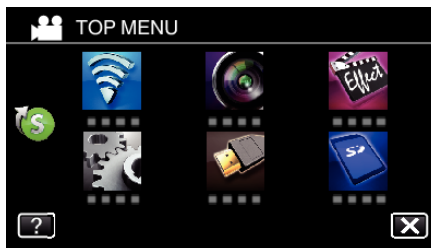

3 Tap "CLOCK ADJUST".

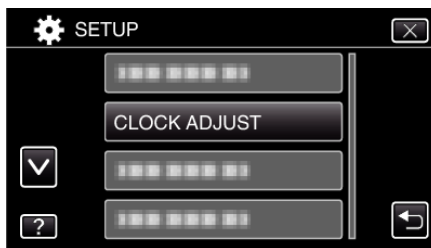

- Tap ^ or v to scroll the screen.

4 Tap "DST SETTING".

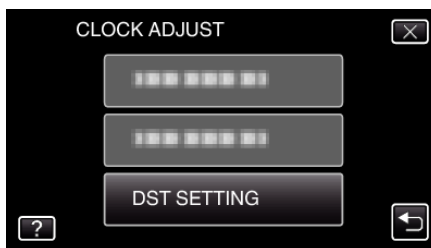

5 Tap "ON".

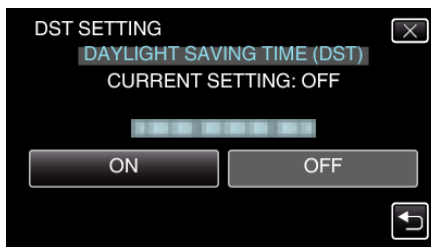

Memo : _____
 • What is daylight saving time?
 Daylight saving time is the system of setting the clock 1 hour ahead for a fixed period in summer.
 It is used mainly in the Western countries.
 • Restore the daylight saving time settings after you returned from the trip.

Optional Accessories

You can record for a longer time by using the optional battery pack.

Product Name	Description
Battery Pack BN-VG114E BN-VG121E BN-VG138E	<ul style="list-style-type: none"> Provides a longer recording time. It can also be used as a spare battery pack.
Battery Charger • AA-VG1	<ul style="list-style-type: none"> Enables the battery pack to be charged without using this unit.
HDMI Mini Cable • VX-HD310 • VX-HD315	<ul style="list-style-type: none"> Allows viewing in high picture quality when connected to a TV. Transmits video, audio, and control signals between devices.

Memo :

- The optional accessories above may not be supported in some regions.
- For more information, refer to the catalog.
- BN-VG108E is not sold separately. BN-VG107E is an equivalent battery pack.
- For details on the provided accessories, refer to “Verifying the Accessories”.

“Verifying the Accessories” (p. 12)

Approximate Recording Time (Using Battery)

■ GZ-EX315

Battery Pack	Actual recording time	Continuous recording time (Maximum Recording Time)
BN-VG114E (Supplied)	1 h 5 m	2 h
BN-VG121E	1 h 40 m	3 h 5 m
BN-VG138E	3 h	5 h 30 m

■ GZ-E307/GZ-E305

Battery Pack	Actual recording time	Continuous recording time (Maximum Recording Time)
BN-VG108E (Supplied: GZ-E305)	40 m	1 h 5 m
BN-VG114E (Supplied: GZ-E307)	1 h 15 m	2 h 10 m
BN-VG121E	1 h 55 m	3 h 15 m
BN-VG138E	3 h 20 m	5 h 45 m

- The above are values when “MONITOR BRIGHTNESS” is set to “3” (standard).
- The actual recording time is an estimate in case that such operations as zooming is used or recording is stopped repeatedly. It may be shorter in the actual usage.
(It is recommended to prepare battery packs ready for three times the expected recording time.)
- When the battery life is reached, the recording time becomes shorter even if the battery pack is fully charged.
(Replace the battery pack with a new one.)

Taking Videos in Auto Mode

You can record without worrying about the setting details by using the Intelligent Auto mode. Settings such as exposure and focus will be adjusted automatically to suit the shooting conditions.

- In case of specific shooting scenes such as person etc., its icon is displayed on the screen.
- Before recording an important scene, it is recommended to conduct a trial recording.

1 Open the lens cover.

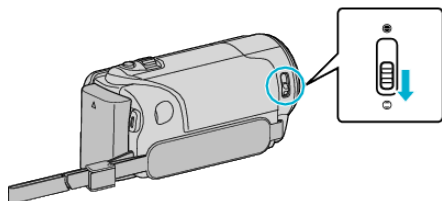

2 Open the LCD monitor.

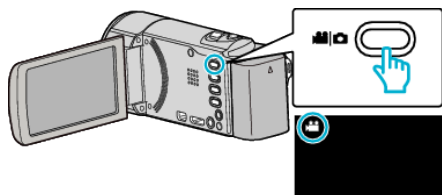

- Check if the recording mode is .
- If the mode is still image, tap on the recording screen to display the mode switching screen. Tap to switch the mode to video.

3 Check if the recording mode is **i.A.** Intelligent Auto.



- If the mode is **M** Manual, tap **M** on the recording screen to display the mode switching screen. Tap **i.A.** to switch the recording mode to Intelligent Auto.

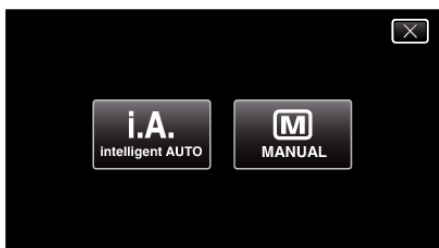

4 Press the START/STOP button to start recording.

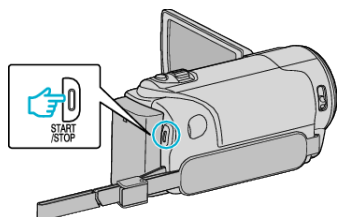

- Press again to stop.
- Some displays disappear after approximately 3 seconds. Use the **D** button to change the displays.

Indications for Video Recording

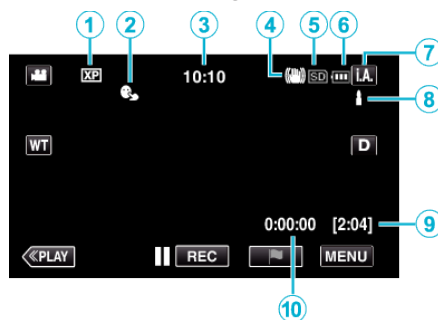

	Display Icon	Description
①	Video Quality	Displays the icon of the "VIDEO QUALITY" setting selected in the recording menu. "VIDEO QUALITY" (p. 207)
②	TOUCH PRIORITY AE/AF	Displays the setting of "TOUCH PRIORITY AE/AF". By default, it is set to "FACE TRACKING". "Capturing Subjects Clearly (TOUCH PRIORITY AE/AF)" (p. 46)
③	Time	Displays the current time. "Clock Setting" (p. 20)
④	Image Stabilizer	Displays the image stabilizer setting. "Reducing Camera Shake" (p. 54)
⑤	Recording Media	Displays the icon of the media where videos are recorded to.
⑥	Battery Indicator	Displays the approximate remaining battery power during use. "Checking the Remaining Recording Time" (p. 63)
⑦	Recording Mode	Displays the current recording mode of i.A. (Intelligent Auto) or M (Manual).
⑧	Setting Scenes of Intelligent Auto	Displays scenes detected automatically in the Intelligent Auto function. Multiple scenes may be detected.
⑨	Remaining Recording Time	Displays the remaining time for video recording. "Checking the Remaining Recording Time" (p. 63)
⑩	Scene Counter (Recorded Time)	Displays the elapsed time of the video that is currently being recorded.

Scenes of Intelligent Auto

Display Icon	Description
	Captures one's skin beautifully.
	Allows people to be captured naturally.
	Record a group of people with the most suitable settings.
	Record the smiling face clearly.
	Records while focusing on a near object.
	Focuses at a far distance and captures a sharp image with vivid colors.
	Records in dark places with minimal noise in the overall image.
	Allows night scenes to be captured accurately with minimal noise in the overall image.
	Prevents colors from fading even when recording in a bright environment, such as snowfield and beaches.
	Prevents colors from fading when recording a subject in a spotlight.
	Reproduces the green color of trees vividly.
	Reproduces the colors of sunset naturally.
	Adjusts settings so that the subject does not appear too dark due to backlight.
	Records while emphasizing the brightness of the colors.
	Reproduces the natural colors of the outdoors during the day.
	Reproduces the natural colors of the indoors in a cold-color illumination.
	Reproduces the natural colors of the indoors in a warm-color illumination.
	Selects the most suitable settings for handheld shooting.
	Selects the most suitable settings when a tripod is used for shooting.

Memo :

- Scenes can be detected according to the shooting conditions and automatically adjusted in Intelligent Auto mode.
- Multiple scenes may be detected depending on the recording conditions.
- Some functions may not work properly depending on the shooting conditions.

Operation Buttons for Video Recording

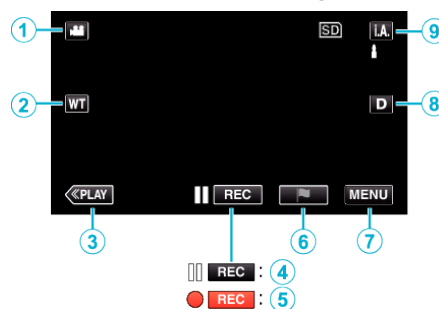



	Operation Buttons	Description
①	Video/Still Image Mode 	Switches between video and still image modes.
②	T/W Zoom	Allows the same functions as the zoom lever to be performed. Camera shake that often occurs when using the zoom lever can be minimized. "Zooming" (p. 32)
③	Playback Mode	Switches to the playback mode.
④ / ⑤	Recording Start Record-Standby 	Functions as the START/STOP button.
⑥	Mark 	By tapping the icon while recording is in progress, you can mark a particular scene to make it easier to find it.
⑦	MENU	Displays the various menus of video recording. "Operating the Menu" (p. 204)
⑧	Display Button D	Switches the display between full (D?) and simple (D) with every tap of the button. <ul style="list-style-type: none"> • Simple display: Some displays disappear after approximately 3 seconds. • Full display: Displays everything. The display button changes from D to D?. • When the power is turned off, simple display (D) will be set.
⑨	Recording Mode i.A.M	Switches the recording mode.

Recording

Using the Silent Mode

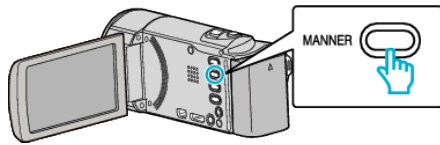
When the Silent mode is used, the LCD monitor darkens and operation sounds will not be output. Use this mode to record quietly in dark places such as during a performance.



- Press and hold the SILENT button to turn on the Silent mode. The Silent mode can be cancelled by holding down the button again.
-  appears when "SILENT MODE" is set to "ON".
- The light is disabled when "SILENT MODE" is set to "ON".

Useful Settings for Recording

- When "QUICK RESTART" is set to "ON", this unit turns on immediately if you open the LCD monitor within 5 minutes after the power is turned off by closing the monitor.

"QUICK RESTART" (☞ p. 219)

- When "AUTO POWER OFF" is set to "ON", this unit turns itself off automatically to conserve power when it is not operated for 5 minutes. (only when using the battery pack)

"AUTO POWER OFF" (☞ p. 219)

- When "TOUCH PRIORITY AE/AF" is set to "FACE TRACKING", this unit detects faces and automatically adjusts its brightness and focus to record the faces more clearly.

"Capturing Subjects Clearly (TOUCH PRIORITY AE/AF)" (☞ p. 46)

- When "DATE/TIME RECORDING" is used, the date and time can be recorded together with the video.

"Recording Videos with Date and Time" (☞ p. 62)

Caution :

- Do not expose the lens to direct sunlight.
- Do not use this unit in the rain, snow, or places with high humidity like the bathroom.
- Do not use this unit in places subject to excessive humidity or dust, as well as places exposed to steam or smoke directly.
- The power may turn off to protect the circuit if the temperature of this unit rises too much.
- Do not remove the battery pack, AC adapter, or SD card when the access lamp is lighted. The recorded data may become unreadable.
- This unit is a microcomputer-controlled device. Electrostatic discharge, external noise and interference (from a TV, a radio, etc.) might prevent it from functioning properly. In such a case, turn off the power, then remove the AC adapter and battery pack. This unit will be reset.
- Disclaimer
 - We shall not be held responsible for loss of recorded contents when recording videos/audio or playback cannot be operated due to malfunctions in this unit, provided parts, or SD card.
 - Once deleted, recorded contents (data), including data loss due to malfunctions in this unit, cannot be restored. Please be forewarned.
 - JVC will not be responsible for any lost data.
 - In order for quality improvement, defective recording medium is subject to be analyzed. Therefore, it may not be returned.

Memo :

- Check the remaining recording time in the media before you start shooting. If there is not enough space, move (copy) the data to a computer or disc.
- When there are many files in the media, it may take time for them to be displayed on the playback screen. Wait for a while as the access lamp appears blinking, which indicates normal operation.
- Do not forget to make copies after recording!
- Recording stops automatically as it cannot be performed for 12 or more consecutive hours according to specifications. (It may take some time to resume recording.)
- For long recordings, the file is split into two or more files if the size exceeds 4 GB.
- You can connect this unit to the AC adapter to record for long hours indoors.
- Depending on the subject and shooting conditions, recording may not be performed properly even in the Intelligent Auto mode.

- Depending on the shooting conditions, the four corners of the screen may appear dark, but this is not a malfunction. In this case, change the shooting conditions by moving the zoom lever, etc.

Capturing Still Images During Video Recording

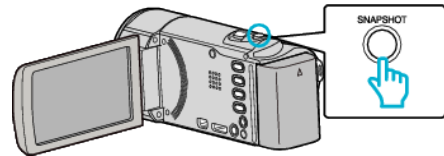

- "PHOTO" lights up on the screen when a still image is being captured.



Memo :

- This function does not support the iFrame recording format. (GZ-EX315)
- The size of the still image that is captured in the video mode is 1,920 x 1,080.
- Operation is invalid under the following conditions:
 - when menu is being displayed
 - when remaining recording time or battery power is being displayed
 - when any functions in "SPECIAL RECORDING" is set

Taking Still Images in Auto Mode

You can record without worrying about the setting details by using the Intelligent Auto mode.

- 1 Open the lens cover.

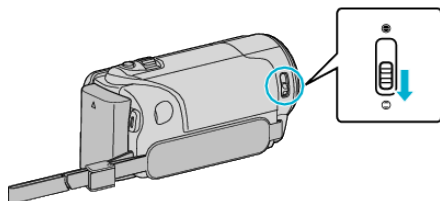

- 2 Open the LCD monitor.

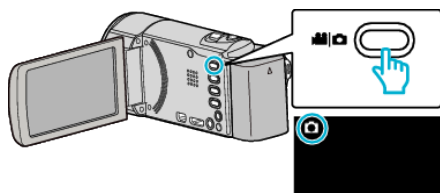

- Check if the recording mode is .
- If the mode is video, tap on the recording screen to display the mode switching screen.
Tap to switch the mode to still image.

- 3 Check if the recording mode is **i.A.**, Intelligent Auto.

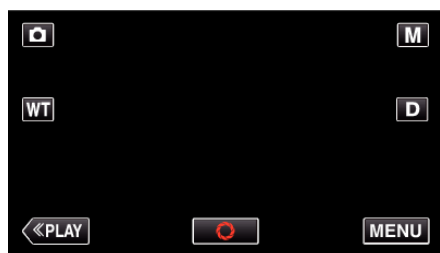

- If the mode is **M** Manual, tap **M** on the recording screen to display the mode switching screen.
Tap **i.A.** to switch the recording mode to Intelligent Auto.

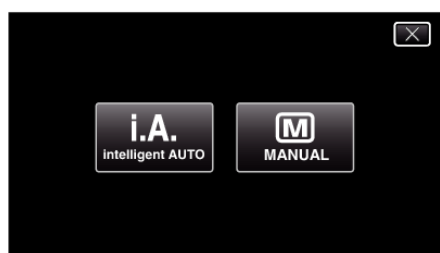

- 4 Set the focus on the subject.

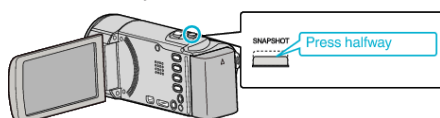

- When focused, the focus icon lights up in green.

- 5 Take a still image.

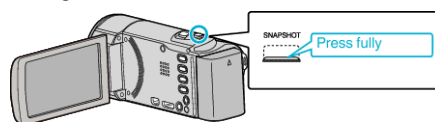

- PHOTO lights up when a still image is being captured.
- After recording, close the lens cover.

Memo :

- Depending on the subject and shooting conditions, recording may not be performed properly even in the Intelligent Auto mode.

Indications During Still Image Recording

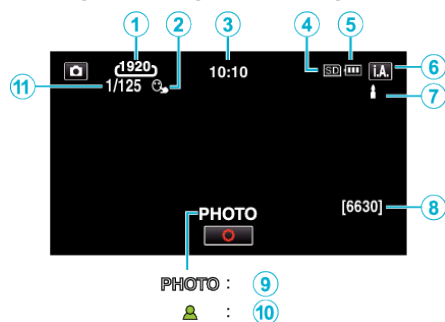

- Some displays disappear after approximately 3 seconds. Use the **D** button to change the displays.

Display Icon	Description
① Image Size	Displays the icon of the image size. <ul style="list-style-type: none"> The size of still images can be changed. "IMAGE SIZE" (p. 212)
② TOUCH PRIORITY AE/AF	Displays the setting of "TOUCH PRIORITY AE/AF". By default, it is set to "FACE TRACKING". "Capturing Subjects Clearly (TOUCH PRIORITY AE/AF)" (p. 46)
③ Time	Displays the current time. "Clock Setting" (p. 20)
④ Recording media	Displays the icon of the media where still images are recorded to.
⑤ Battery Indicator	Displays the approximate remaining battery power during use. "Checking the Remaining Recording Time" (p. 63)
⑥ Recording Mode	Displays the current recording mode of i.A. (Intelligent Auto) or M (Manual).
⑦ Setting Scenes of Intelligent Auto	Displays scenes detected automatically in the Intelligent Auto function. Multiple scenes may be detected.
⑧ Remaining Number of Shots	Displays the remaining number of shots for still image recording. "Approximate Number of Still Images (Unit: Number of Shots)" (p. 64)
⑨ Recording in Progress	"PHOTO" appears when a still image is being captured.
⑩ Focus	Lights up in green when focused.
⑪ Shutter Speed	Displays the shutter speed.

Scenes of Intelligent Auto

Display Icon	Description
	Captures one's skin beautifully.
	Allows people to be captured naturally.
	Record a group of people with the most suitable settings.
	Record the smiling face clearly.
	Records while focusing on a near object.
	Focuses at a far distance and captures a sharp image with vivid colors.
	Records in dark places with minimal noise in the overall image.
	Allows night scenes to be captured accurately with minimal noise in the overall image.
	Prevents colors from fading even when recording in a bright environment, such as snowfield and beaches.
	Prevents colors from fading when recording a subject in a spotlight.
	Reproduces the green color of trees vividly.
	Reproduces the colors of sunset naturally.
	Adjusts settings so that the subject does not appear too dark due to backlight.
	Records while emphasizing the brightness of the colors.
	Reproduces the natural colors of the outdoors during the day.
	Reproduces the natural colors of the indoors in a cold-color illumination.
	Reproduces the natural colors of the indoors in a warm-color illumination.
	Selects the most suitable settings for handheld shooting.
	Selects the most suitable settings when a tripod is used for shooting.

Memo :

- Scenes can be detected according to the shooting conditions and automatically adjusted in Intelligent Auto mode.
- Multiple scenes may be detected depending on the recording conditions.
- Some functions may not work properly depending on the shooting conditions.

Operation Buttons for Still Image Recording

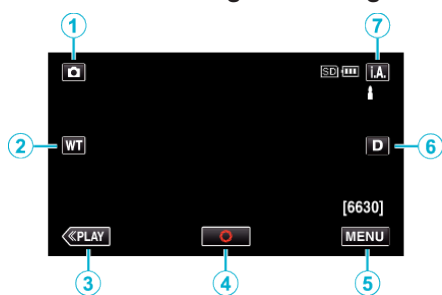

	Operation Buttons	Description
①	Video/Still Image Mode 	Switches between video and still image modes.
②	T/W Zoom	Allows the same functions as the zoom lever to be performed. Camera shake that often occurs when using the zoom lever can be minimized. "Zooming" (p. 32)
③	Playback Mode	Switches to the playback mode.
④	Snapshot 	Functions as the SNAPSHOT button. However, focus cannot be set by pressing halfway.
⑤	MENU	Displays the various menus of still image recording. "Operating the Menu" (p. 204)
⑥	Display Button D	Switches the display between full (D_L) and simple (D) with every tap of the button. <ul style="list-style-type: none"> Simple display: Some displays disappear after approximately 3 seconds. Full display: Displays everything. The display button changes from D to D_L. When the power is turned off, simple display (D) will be set.
⑦	Recording Mode i.A.M	Switches the recording mode.

Using the Silent Mode

When the Silent mode is used, the LCD monitor darkens and operation sounds will not be output. Use this mode to record quietly in dark places such as during a performance.

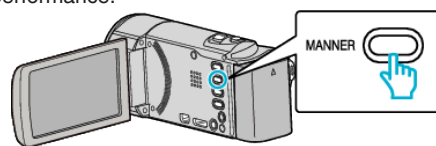

- Press and hold the SILENT button to turn on the Silent mode. The Silent mode can be cancelled by holding down the button again.
- appears when "SILENT MODE" is set to "ON".

Useful Settings for Recording

- When "QUICK RESTART" is set to "ON", this unit turns on immediately if you open the LCD monitor within 5 minutes after the power is turned off by closing the monitor.
- "QUICK RESTART" (p. 219)
- When "AUTO POWER OFF" is set to "ON", this unit turns itself off automatically to conserve power when it is not operated for 5 minutes. (only when using the battery pack)
- "AUTO POWER OFF" (p. 219)
- When "TOUCH PRIORITY AE/AF" is set to "FACE TRACKING", this unit detects faces and automatically adjusts its brightness and focus to record the faces more clearly.
- "Capturing Subjects Clearly (TOUCH PRIORITY AE/AF)" (p. 46)

Caution :

- Do not expose the lens to direct sunlight.
- Do not use this unit in the rain, snow, or places with high humidity like the bathroom.
- Do not use this unit in places subject to excessive humidity or dust, as well as places exposed to steam or smoke directly.
- The power may turn off to protect the circuit if the temperature of this unit rises too much.
- Do not remove the battery pack, AC adapter, or SD card when the access lamp is lighted. The recorded data may become unreadable.
- This unit is a microcomputer-controlled device. Electrostatic discharge, external noise and interference (from a TV, a radio, etc.) might prevent it from functioning properly. In such a case, turn off the power, then remove the AC adapter and battery pack. This unit will be reset.

Memo :

- Before recording an important scene, it is recommended to conduct a trial recording.
- Depending on the shooting conditions, the four corners of the screen may appear dark, but this is not a malfunction. In this case, change the shooting conditions by moving the zoom lever, etc.

Zooming

The angle of view can be adjusted using zoom.

- Use the W end (wide angle end) to shoot a wider field of view.
- Use the T end (telephoto end) to magnify the subject for shooting.

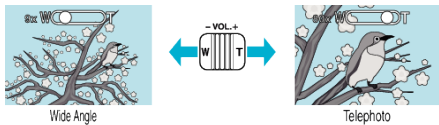

- You can also use the zoom (T/W) button on the touch screen to zoom.

Zoom Button (T/W)

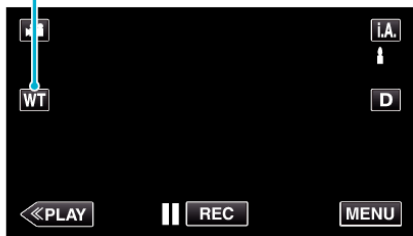

Memo :

- When digital zoom is used, the image becomes grainy as it is digitally enlarged.
- The zoom ratio range can be changed.

“ZOOM” (p. 208)

Manual Recording

You can adjust settings, such as brightness, by using the manual mode. Manual recording can be set for both video and still image modes. *The following is a screen of the model with Wi-Fi functions.

- 1 Open the lens cover.

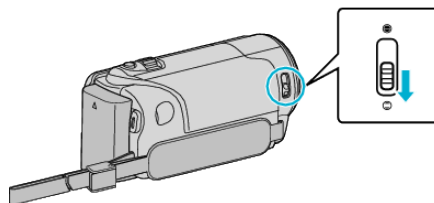

- 2 Open the LCD monitor.

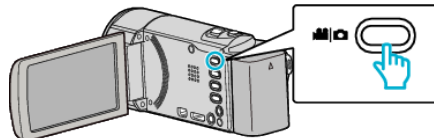

- Set the recording mode to either video or still image.
- To switch the mode between video and still image, tap or on the recording screen to display the mode switching screen. Tap or to switch the mode to video or still image respectively. (You can also use the / button on this unit.)

- 3 Select the Manual recording mode.



- If the mode is **i.A.**, Intelligent Auto, tap **i.A.** on the recording screen to display the mode switching screen. Tap **M** to switch the recording mode to Manual.

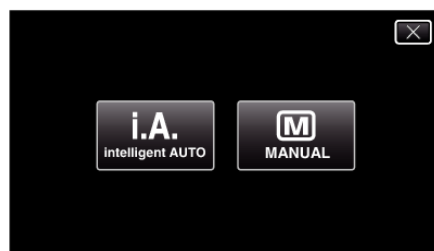

- 4 Tap “MENU”.



- The top menu appears.

- 5 Tap “RECORD SETTING”.

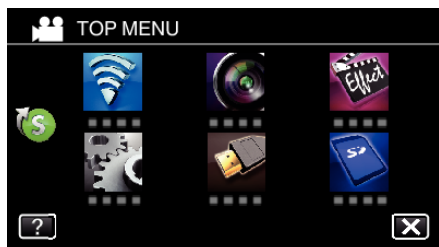

- 6 Tap the item to set manually.

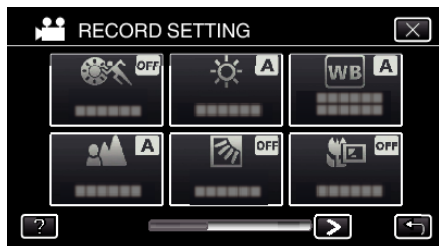

- For details on the various manual settings, refer to “Manual Recording Menu”.

Manual Recording Menu

The following items can be set.

Name	Description
SCENE SELECT	<ul style="list-style-type: none"> Recordings that suit the shooting conditions can be performed easily. “Shooting According to Scene (Subject)” (☞ p. 34)
FOCUS	<ul style="list-style-type: none"> Use manual focus if the subject is not focused automatically. “Adjusting Focus Manually” (☞ p. 35)
BRIGHTNESS ADJUST	<ul style="list-style-type: none"> Overall brightness on the screen can be adjusted. Use this when recording in a dark or bright location. “Adjusting Brightness” (☞ p. 36)
BACKLIGHT COMP.	<ul style="list-style-type: none"> Corrects the image when the subject appears dark due to backlight. Use this when shooting against the light. “Setting Backlight Compensation” (☞ p. 37)
WHITE BALANCE	<ul style="list-style-type: none"> Overall color on the screen can be adjusted. Use this when the color on the screen appears differently from the actual color. “Setting White Balance” (☞ p. 38)
TELE MACRO	<ul style="list-style-type: none"> Use this to take close-up (macro) shots of the subject. “Taking Close-up Shots” (☞ p. 39)

Shooting According to Scene (Subject)

Common scenes that are often encountered can be recorded with the most suitable settings.

*The following is a screen of the model with Wi-Fi functions.

- 1 Select the Manual recording mode.



- If the mode is **i.A.**, Intelligent Auto, tap **i.A.** on the recording screen to display the mode switching screen. Tap **M** to switch the recording mode to Manual.

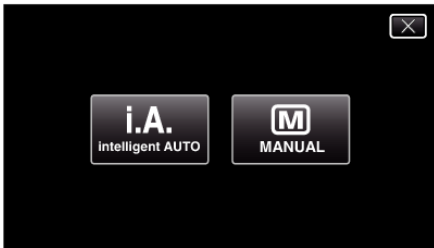

- 2 Tap "MENU".



- The top menu appears.

- 3 Tap "RECORD SETTING".

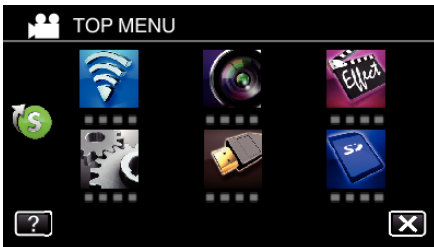

- 4 Tap "SCENE SELECT".

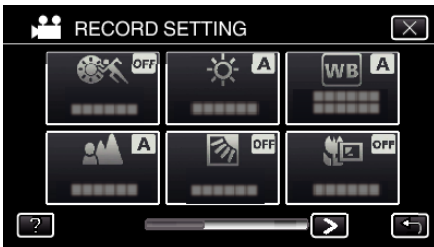





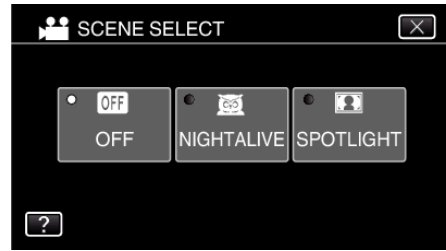

- Tap < or > to move to the previous/next menu.
- Tap X to exit the menu.
- Tap ↶ to return to the previous screen.

- 5 Tap the appropriate scene.



- Tap "OFF" to cancel the selection.
- Tap X to exit the menu.

*The image is only an impression.

Setting	Effect
 NIGHTALIVE	Increases gain and brightens the scene automatically using a slow shutter when the surrounding is dark. To prevent camera shake, use a tripod. <div style="display: flex; justify-content: space-around;"> <div style="text-align: center;"> OFF  </div> <div style="text-align: center;"> ON  </div> </div>
 SPOTLIGHT	Prevents the human subject from appearing too bright under light. <div style="display: flex; justify-content: space-around;"> <div style="text-align: center;"> OFF  </div> <div style="text-align: center;"> ON  </div> </div>

Memo :

- All scenes of "SCENE SELECT" cannot be set during "HIGH SPEED RECORDING" or "AUTO REC".

Adjusting Focus Manually

Set this when the focus is not clear in Intelligent Auto or when manual focusing is desired.

*The following is a screen of the model with Wi-Fi functions.

- Select the Manual recording mode.

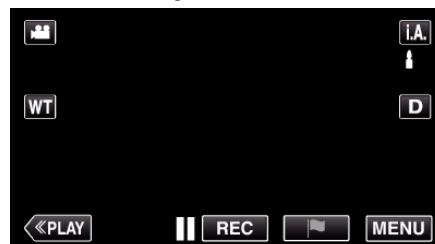

- If the mode is **i.A.**, Intelligent Auto, tap **i.A.** on the recording screen to display the mode switching screen. Tap **M** to switch the recording mode to Manual.

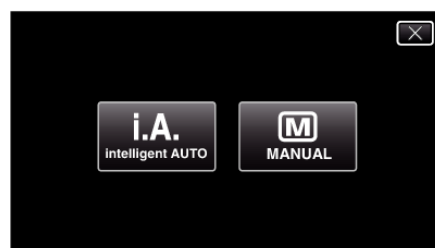

- Tap "MENU".

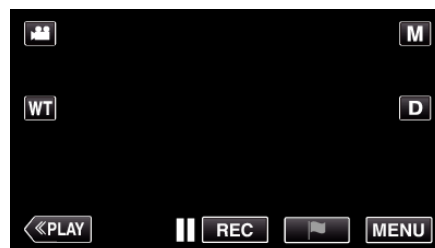

- The top menu appears.

- Tap "RECORD SETTING".

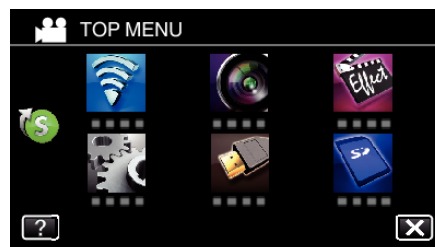

- Tap "FOCUS".



- Tap X to exit the menu.
- Tap ↶ to return to the previous screen.

- Tap "MANUAL".

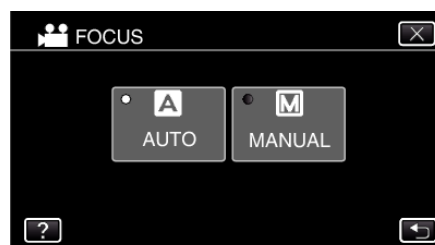

6 Adjust the focus.



- Tap ▲ to focus on a distant subject.
If ▲ appears blinking, focus cannot be set any further.
- Tap ▼ to focus on a near subject.
If ▼ appears blinking, focus cannot be set any nearer.

7 Tap "SET" to confirm.



- When focus is confirmed, the focusing frame disappears and ▲ and ▼ are displayed.

Adjusting Brightness

You can adjust the brightness to your preferred level.

*The following is a screen of the model with Wi-Fi functions.

1 Select the Manual recording mode.



- If the mode is **i.A.**, Intelligent Auto, tap **i.A.** on the recording screen to display the mode switching screen.
Tap **M** to switch the recording mode to Manual.

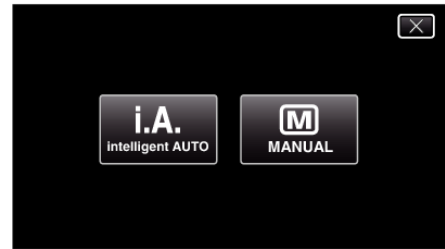

2 Tap "MENU".



- The top menu appears.

3 Tap "RECORD SETTING".

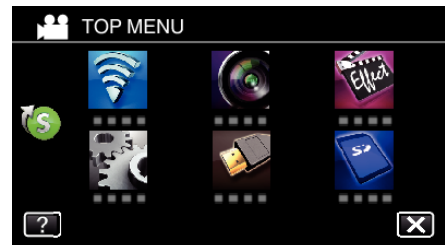

4 Tap "BRIGHTNESS ADJUST".

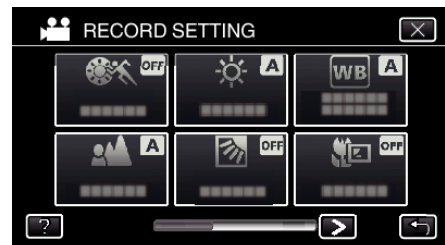

- Tap X to exit the menu.
- Tap ↶ to return to the previous screen.

- 5 Tap "MANUAL".

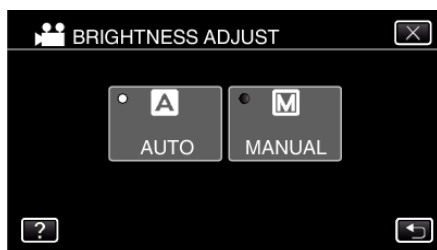

- 6 Adjust the brightness value.



- Compensation range: -2.0 to +2.0
- Tap \wedge to increase the brightness.
- Tap \vee to decrease the brightness.

- 7 Tap "SET" to confirm.



Memo :

- Settings can be adjusted separately for videos and still images.

Setting Backlight Compensation

You can correct the image when the subject appears too dark due to backlight.

*The following is a screen of the model with Wi-Fi functions.

- 1 Select the Manual recording mode.



- If the mode is **i.A.**, Intelligent Auto, tap **i.A.** on the recording screen to display the mode switching screen. Tap **M** to switch the recording mode to Manual.

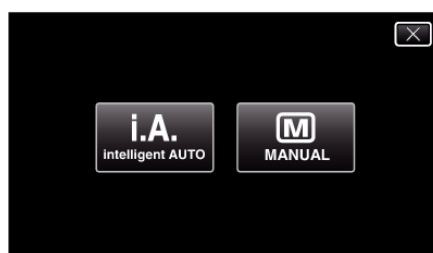

- 2 Tap "MENU".

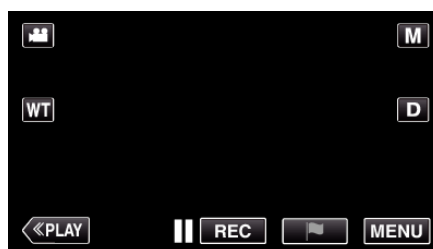

- The top menu appears.

- 3 Tap "RECORD SETTING".

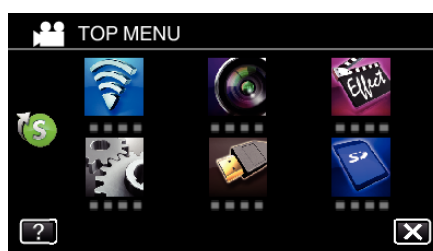



- 4 Tap "BACKLIGHT COMP.".

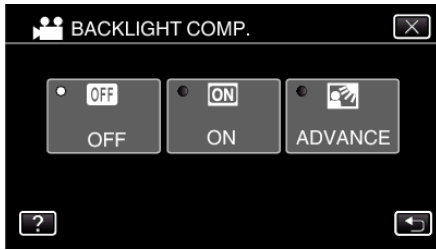

- Tap \times to exit the menu.
- Tap \leftarrow to return to the previous screen.

5 Tap "ON" or "ADVANCE".



- "ADVANCE" is designed to perform more effective backlight compensation. Choose this when the backlight compensation is not adjusted appropriately by "ON".
- After setting, the backlight icon  appears.

Setting	Details
OFF	Backlight compensation is disabled.
ON	Backlight compensation is enabled.
ADVANCE	Should be selected for a better backlight compensation effect.

Setting White Balance

You can set the color tone to suit the light source.

*The following is a screen of the model with Wi-Fi functions.

1 Select the Manual recording mode.



- If the mode is **i.A.**, Intelligent Auto, tap **i.A.** on the recording screen to display the mode switching screen. Tap **M** to switch the recording mode to Manual.

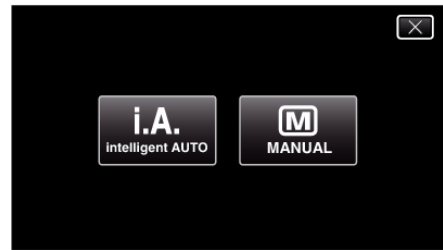

2 Tap "MENU".

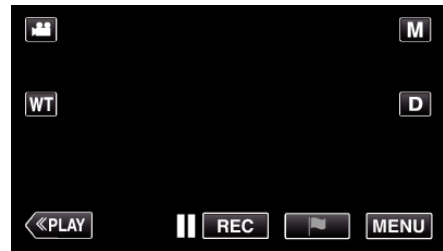

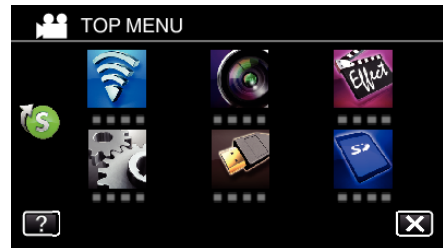

- The top menu appears.

3 Tap "RECORD SETTING".

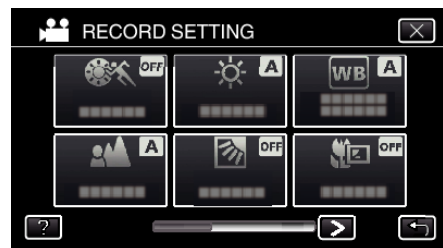

4 Tap "WHITE BALANCE".



- Tap **X** to exit the menu.
- Tap  to return to the previous screen.

5 Tap the appropriate shooting environment.



- Select the item by using < or >, then tap “SET”. (Tap the icon directly to select.)
- The White Balance icon appears on the screen upon completing the setting.

Setting	Details
AUTO	Adjusts automatically to the natural colors.
MWB	Use this when the problem of unnatural colors is not resolved.
FINE	Set this when shooting outdoors on a sunny day.
CLOUD	Set this when shooting on a cloudy day or inside a shade.
HALOGEN	Set this when shooting under illumination such as a video light.
MARINE:BLUE	Set this when shooting the sea at deep water area (water appears blue) using an optional marine case.
MARINE:GREEN	Set this when shooting the sea at shallow water area (water appears green) using an optional marine case.

Using MWB

- 1 Hold a sheet of plain white paper in front of the lens so that the white paper fills the screen.
- 2 Position the cursor to “MWB”, and press and hold “SET”. Or, press and hold the “MWB” icon.
- 3 Release your touch after the menu disappears and the camera lights up.

Memo :

- The setting will not change if “MWB” is being tapped too fast (less than 1 second).

Taking Close-up Shots

You can take close-up shots of an object using the tele macro function.
*The following is a screen of the model with Wi-Fi functions.



*The image is only an impression.

1 Select the Manual recording mode.

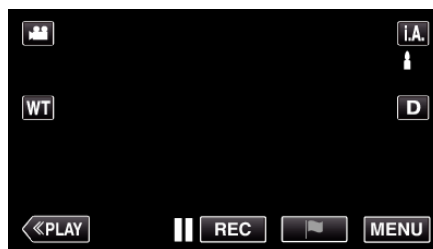

- If the mode is **i.A.** Intelligent Auto, tap **i.A.** on the recording screen to display the mode switching screen. Tap **M** to switch the recording mode to Manual.

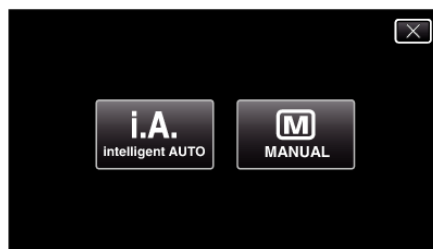

2 Tap “MENU”.

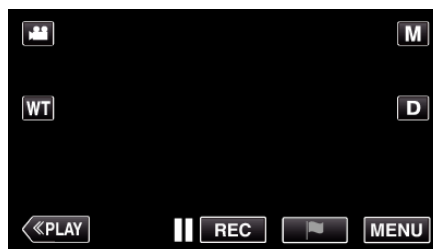

- The top menu appears.

3 Tap “RECORD SETTING”.

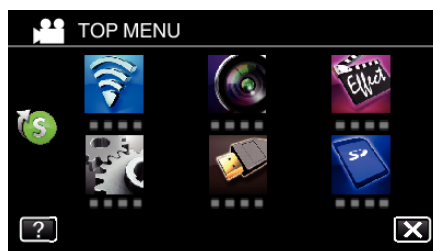

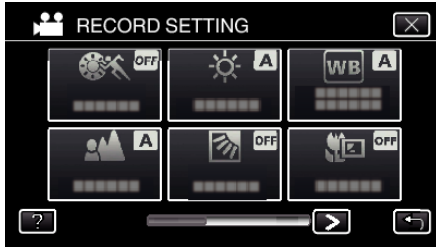

4 Tap "TELE MACRO".

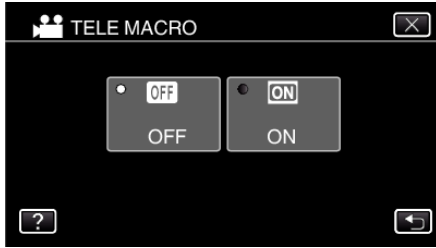

- Tap X to exit the menu.
- Tap ↩ to return to the previous screen.

5 Tap "ON".



- After setting, the tele macro icon  appears.

Setting	Details
OFF	Enables close-up shots up to 1 m at the telephoto (T) end. Enables close-up shots up to 5 cm at the wide angle (W) end.
ON	Enables close-up shots up to 50 cm at the telephoto (T) end. Enables close-up shots up to 5 cm at the wide angle (W) end.

Caution :

- When you are not taking close-up shots, set "TELE MACRO" to "OFF". Otherwise, the image may be blur.

Recording with Effects

You can add animation effects to video recordings.

The animation effects appear when smiles are detected or when the screen is touched.

Type of Effect	Description of Effect
ANIMATION EFFECT	Records videos with animation effects. "Recording with Animation Effects (ANIMATION EFFECT)" (p. 41)
DECORATE FACE EFFECT	Detects faces and enables decorations such as crowns or sunglasses to be added. "Recording with Face Decorations (DECORATE FACE EFFECT)" (p. 43)
STAMP	Records videos with various decorative stamps. "Recording with Decorative Stamps (STAMP)" (p. 44)
HANDWRITING EFFECT	Records videos with your personal handwriting or drawing. "Recording with Personal Handwriting (HANDWRITING EFFECT)" (p. 45)

Recording with Animation Effects (ANIMATION EFFECT)

You can add animation effects to video recordings. The animation effects appear when smiles are detected or when the screen is touched.

*The following is a screen of the model with Wi-Fi functions.

- 1 Open the LCD monitor.

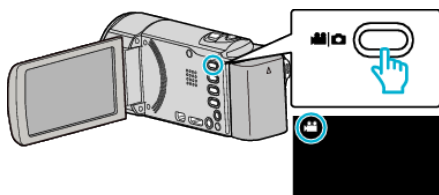

- Check if the recording mode is .
- If the mode is still image, tap on the recording screen to display the mode switching screen. Tap to switch the recording mode. (You can also use the button on this unit.)

- 2 Tap "MENU".

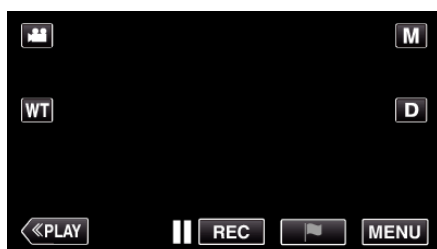

- The top menu appears.

- 3 Tap "SPECIAL RECORDING". (Go to step 4.) Alternatively, tap "ANIMATION EFFECT" in the shortcut menu. (Go to step 5.)



- 4 Tap "ANIMATION EFFECT".

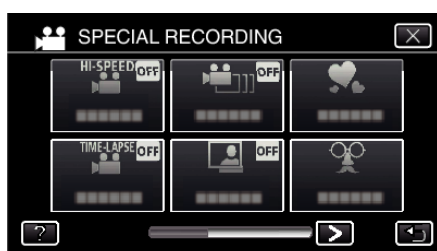





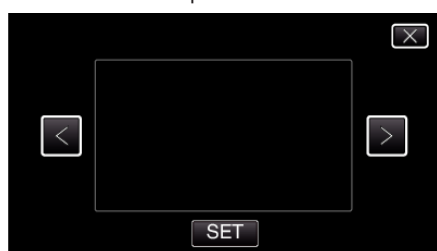





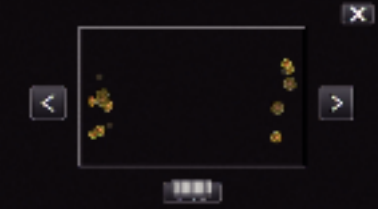
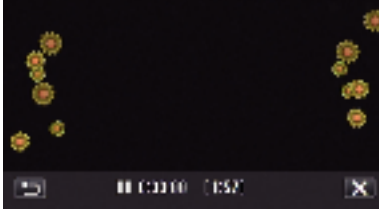

- Tap to exit the menu.
- Tap to return to the previous screen.

- 5 Select a desired effect and tap "SET".

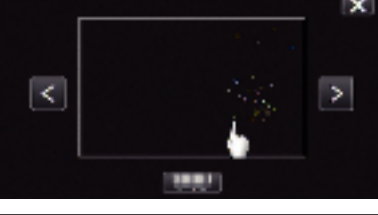

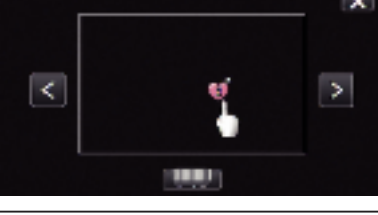
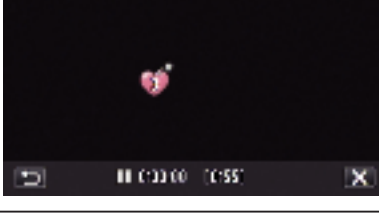
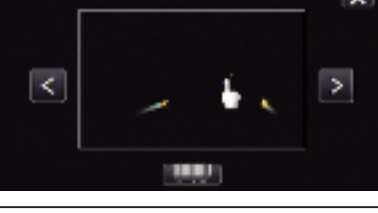
- Tap or to change the effect.
- Press the START/STOP button the camera to start recording. Press again to stop.
- To select another effect again after tapping "SET", tap .

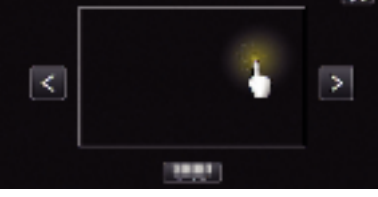
- Tap to exit "ANIMATION EFFECT". (To perform operations other than recording, tap to cancel the "ANIMATION EFFECT" first.)

During Setting	After Setting	Note
		<p>Animation (effect) appears when smiles are detected.</p>
		<p>Animation (effect) appears when smiles are detected.</p>
		<p>Animation (effect) appears when smiles are detected.</p>
		<p>Animation (effect) appears when smiles are detected.</p>
		<p>Animation (effect) appears when the screen is touched.</p>
		<p>Animation (effect) appears when the screen is touched.</p>
		<p>Animation (effect) appears when the screen is touched.</p>
		<p>Animation (effect) appears when the screen is touched.</p>

Recording with Face Decorations (DECORATE FACE EFFECT)

Detects faces and enables decorations such as crowns or sunglasses to be added.

*The following is a screen of the model with Wi-Fi functions.

- 1 Open the LCD monitor.

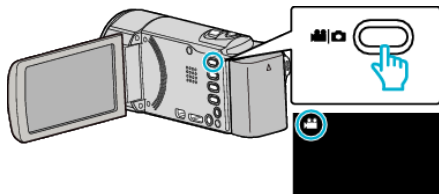

- Check if the recording mode is .
- If the mode is still image, tap on the recording screen to display the mode switching screen. Tap to switch the recording mode. (You can also use the button on this unit.)

- 2 Tap "MENU".

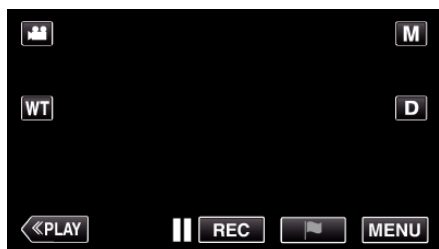

- The top menu appears.

- 3 Tap "SPECIAL RECORDING". (Go to step 4.)
Alternatively, tap "DECORATE FACE EFFECT" in the shortcut menu. (Go to step 5.)

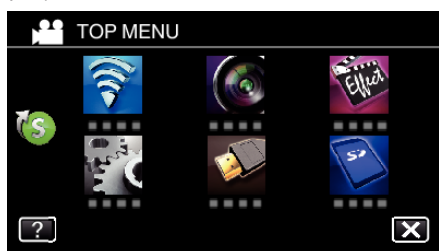

- 4 Tap "DECORATE FACE EFFECT".



- Tap to exit the menu.
- Tap to return to the previous screen.

- 5 Select a desired effect and tap "SET".



- Tap or to select an item.
- Press the START/STOP button the camera to start recording. Press again to stop.
- To select another effect again after tapping "SET", tap .
- Tap to exit "DECORATE FACE EFFECT". (To perform operations other than recording, tap to cancel the "DECORATE FACE EFFECT" first.)

Recording with Decorative Stamps (STAMP)

Records videos with various decorative stamps.

*The following is a screen of the model with Wi-Fi functions.

1 Open the LCD monitor.

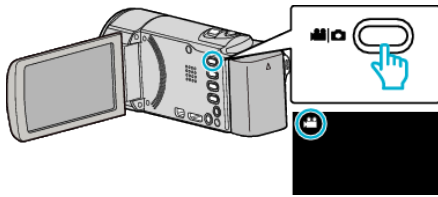

- Check if the recording mode is .
- If the mode is still image, tap on the recording screen to display the mode switching screen.
Tap to switch the recording mode. (You can also use the button on this unit.)

2 Tap "MENU".



- The top menu appears.

3 Tap "SPECIAL RECORDING".

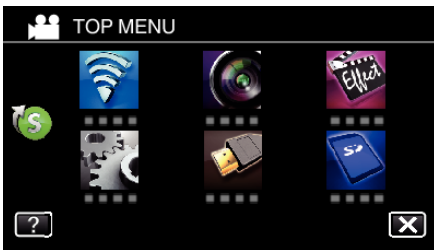

4 Tap > on the lower right of the screen.

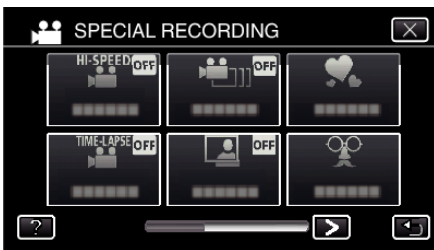

5 Tap "STAMP".



- Tap to exit the menu.
- Tap to return to the previous screen.

6 Select a stamp.

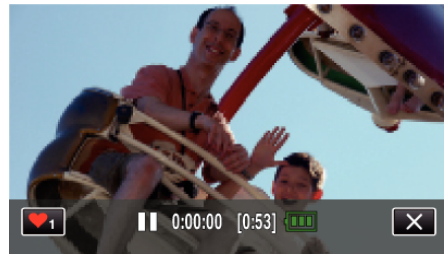

- Tap to start selecting a stamp. Tap on the desired stamp to use. The number indicates the size of the stamp.

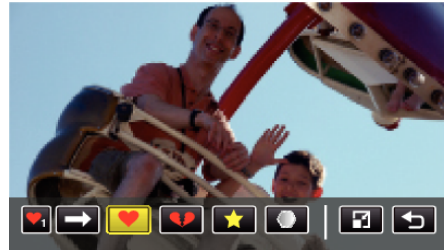

- Tap to scroll through the list of stamps.
- Tap to change the size of stamps.
- Tap to return to the previous screen.

7 Tap on the screen to add a stamp.

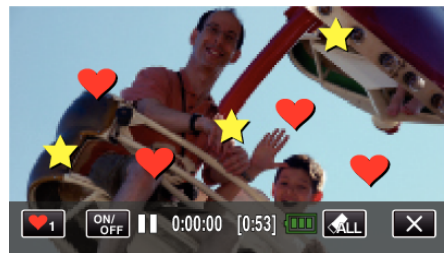

- Tap and the "YES" button to delete the stamp.
- Tap "ON/OFF" to display/hide the stamps.
- Press the START/STOP button the camera to start recording. Press again to stop.
- Tap to exit "STAMP".
(To perform operations other than recording, tap to cancel the "STAMP" first.)

Memo :

- Up to 50 stamps may be added.
- The added stamps are deleted when the stamp mode ends or when power is turned off.

Recording with Personal Handwriting (HANDWRITING EFFECT)

Records videos with your personal handwriting or drawing.
*The following is a screen of the model with Wi-Fi functions.

- 1 Open the LCD monitor.

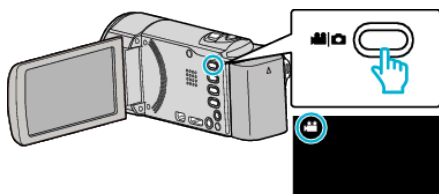

- Check if the recording mode is .
- If the mode is still image, tap on the recording screen to display the mode switching screen.
Tap to switch the recording mode. (You can also use the button on this unit.)

- 2 Tap "MENU".



- The top menu appears.

- 3 Tap "SPECIAL RECORDING".

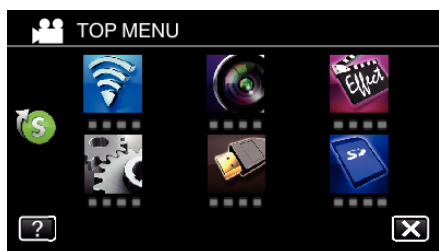

- 4 Tap > on the lower right of the screen.



- 5 Tap "HANDWRITING EFFECT".



- Tap X to exit the menu.
- Tap to return to the previous screen.

- 6 Select a line.

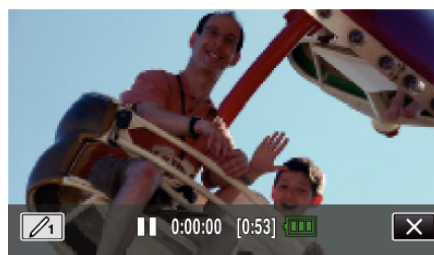

- Tap to select the line color and thickness. The number indicates the thickness of the line.

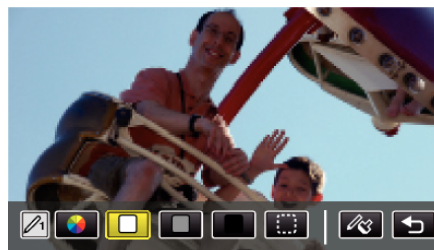

- You can select a color from white, gray, black, etc.
- Select to tap and erase part of the line.
- Tap to select the line color.
Tap to scroll through the list of colors.
- Tap to select the line thickness.
- Tap to return to the previous screen.

- 7 Draw a line with your finger.

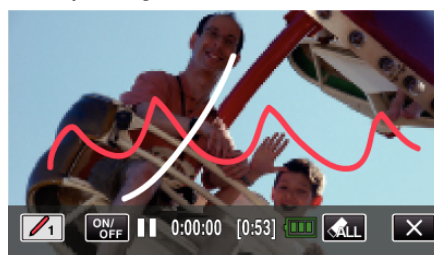

- Tap and the YES button to delete all the lines.
- Tap "ON/OFF" to display/hide the lines.
- Press the START/STOP button the camera to start recording.
Press again to stop.
- Tap X to exit "HANDWRITING EFFECT".
(To perform operations other than recording, tap X to cancel the "HANDWRITING EFFECT" first.)

Memo :

- If the writings and drawings appear to be misaligned, correct the touch position.

"Adjusting the Touch Panel" (p. 17)

- The writings and drawings are deleted when the handwriting mode ends or when the power is turned off.

Capturing Subjects Clearly (TOUCH PRIORITY AE/AF)

“TOUCH PRIORITY AE/AF” is a function that adjusts focus and brightness based on a tapped position.

By registering the face of a person beforehand, you can enable tracking of the person even without specific selection during recording.

This function is available for both videos and still images.

*The following is a screen of the model with Wi-Fi functions.

1 Open the LCD monitor.

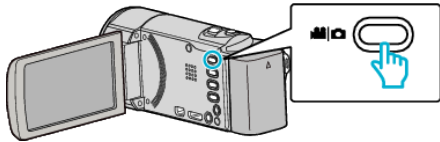

- Set the recording mode to either video or still image.
- To switch the mode between video and still image, tap or on the recording screen to display the mode switching screen. Tap or to switch the mode to video or still image respectively. (You can also use the / button on this unit.)

2 Tap “MENU”.



- The top menu appears.

3 Tap “RECORD SETTING”.

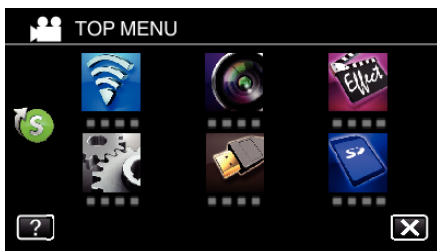

4 Tap on the lower right of the screen.

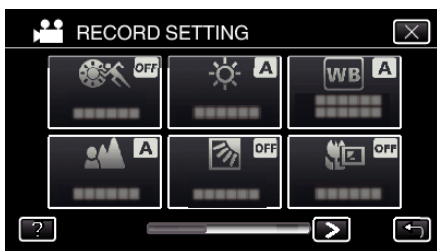

5 Tap “TOUCH PRIORITY AE/AF”.

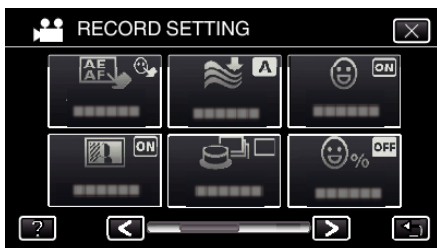

- Tap to exit the menu.
- Tap to return to the previous screen.

6 Tap the desired setting.



FACE TRACKING



PET TRACKING

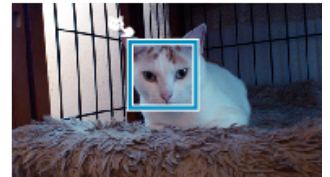

COLOR TRACKING



AREA SELECT



- Focus and brightness will be adjusted automatically based on the tapped position (face/color/area). A blue frame appears around the selected subject (face/color), while a white frame appears around the selected area.
- To reset, tap the desired position (face/color/area) again.
- To cancel “FACE TRACKING”, “PET TRACKING”, or “COLOR TRACKING”, tap the blue frame.
- To cancel “AREA SELECT”, tap the white frame.

Setting	Details
OFF	Deactivates the function.
FACE TRACKING	appears on the screen. Recording is performed while tracking and automatically adjusting the tapped face (subject) with appropriate focus and brightness. In addition, a blue frame appears around the tapped face (subject). (When the face of a person is registered, it becomes the main subject and the blue frame appears even without specific selection.)
PET TRACKING	appears on the screen. Recording is performed while tracking and automatically adjusting the face of the tapped pet (subject) with appropriate brightness. In addition, a blue frame appears around the tapped pet (subject).
COLOR TRACKING	appears on the screen. Recording is performed while tracking and automatically adjusting the tapped color (subject) with appropriate focus and brightness. In addition, a blue frame appears around the tapped color (subject).
AREA SELECT	appears on the screen. Recording is performed while automatically adjusting the tapped area (fixed position) with appropriate focus and brightness. In addition, a white frame appears around the tapped area. AREA SELECT in TOUCH PRIORITY AE/AF is only available within the optical zoom range. (unavailable when digital zoom is being used)

Memo :

- When “TOUCH PRIORITY AE/AF” is set, “FOCUS” will be set to “AUTO” automatically.
- Tap the selected position (face/color/area) again to cancel the setting. (Setting remains for registered faces.)
- Tap on an unselected position (face/color/area) to reset.
- If the camera loses track of a subject, tap the subject again.
- Settings are canceled when zoom operation is performed. (“AREA SELECT” only)
- When “FACE TRACKING” is set after face registration, the blue frame appears around the face with the highest priority registered.
- When recording registered faces using “FACE TRACKING”, focus and brightness will be adjusted automatically even without specific selection. In addition, registered faces may be tracked back again even if they are lost. Therefore, it is recommended to register the faces that are often being recorded by this camera beforehand.

“Registering Human Face Personal Authentication Information”
( p. 50)

- When “COLOR TRACKING” is set, the targeted subject (color) may change if similar colors are detected. In this case, tap the subject again. The targeted subject (color) may also be tracked back again if it appears in the center of the screen within a specific time.

Caution :

- Subjects near the sides of the LCD monitor may not respond or be recognized when tapped. In this case, move the subject to the center and tap again.
- “FACE TRACKING” may not work properly depending on the shooting conditions (distance, angle, brightness, etc.) and the subject (direction of face, etc.). It is also particularly difficult to detect faces in backlight.
- “PET TRACKING” may not work properly depending on the type of pet, shooting conditions (distance, angle, brightness, etc.) and the subject (direction of face, etc.). It is also particularly difficult to detect faces of pets that are totally black, covered in long hair, or in backlight.
- “COLOR TRACKING” may not function properly in the following cases:
 - when recording subjects with no contrast
 - when recording subjects that are moving at high speed
 - when recording in a dark place
 - when the surrounding brightness changes
- “AREA SELECT” is not available while the digital zoom is in use.
- When “FACE TRACKING” is set, the subject may be lost if the camera is moved vertically or horizontally very fast. For unregistered faces, they cannot be tracked back again. To track back the subject, tap on it again. For registered faces, focus and brightness will be adjusted automatically even without specific selection. In addition, registered faces may be tracked back again even if they are lost. Therefore, it is recommended to register the faces that are often being recorded by this camera beforehand.

“Registering Human Face Personal Authentication Information”
( p. 50)

Capturing Smiles Automatically (SMILE SHOT)

“SMILE SHOT” automatically captures a still image upon detection of a smile.

This function is available for both videos and still images.







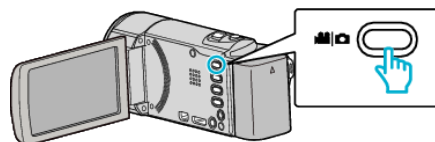

Set “TOUCH PRIORITY AE/AF” to “FACE TRACKING” before selecting “SMILE SHOT”.

“Capturing Subjects Clearly (TOUCH PRIORITY AE/AF)” ( p. 46)

*The following is a screen of the model with Wi-Fi functions.

- 1 Open the LCD monitor.



- Set the recording mode to either  video or  still image.
- To switch the mode between video and still image, tap  or  on the recording screen to display the mode switching screen. Tap  or  to switch the mode to video or still image respectively. (You can also use the / button on this unit.)

- 2 Tap “MENU”.



- The top menu appears.

- 3 Tap “RECORD SETTING”. (Go to step 4.)
Alternatively, tap “SMILE SHOT” in the shortcut menu. (Go to step 6.)

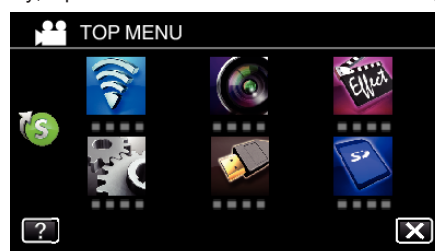



- 4 Tap > on the lower right of the screen.



- 5 Tap “SMILE SHOT”.



- Tap  to exit the menu.
- Tap  to return to the previous screen.

- 6 Tap “ON”.

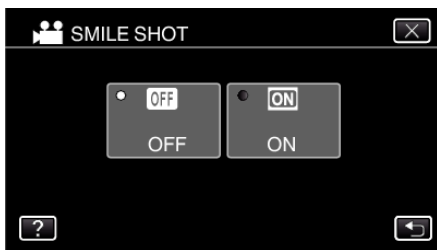

- Tap X to exit the menu as the previous screen appears.

7 Point the camera toward the human subject.

- A still image is automatically captured when smiles are detected.

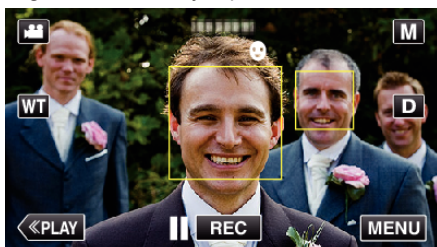

- PHOTO lights up when a still image is being captured.
- You can display the name and smile level (%) together with the frame by setting “SMILE%/NAME DISPLAY” in the menu to “ON” before recording.

“Setting SMILE%/NAME DISPLAY” (p. 52)

Memo :

- The camera is able to detect up to 16 faces. Smile levels will be displayed for up to 3 of the largest faces displayed on the screen.
- This function may not work properly depending on the shooting conditions (distance, angle, brightness, etc.) and the subject (direction of face, smile level, etc.). It is also difficult to detect a smile in backlight.
- After a smile is detected and captured, it takes time before the next recording may be performed.
- “SMILE SHOT” does not work in the following cases:
 - when menu is being displayed
 - when remaining recording time or battery power is being displayed
 - when any functions in “SPECIAL RECORDING” is set

Caution :

- If “TOUCH PRIORITY AE/AF” is not set to “FACE TRACKING”, “SMILE SHOT” will not work.
- If appropriate results cannot be obtained, record with “SMILE SHOT” set to “OFF”.

Capturing Pets Automatically (PET SHOT)

“PET SHOT” automatically captures a still image upon detection of the face of a pet, such as dogs or cats.

This function is available for both videos and still images.

*The following is a screen of the model with Wi-Fi functions.

1 Open the LCD monitor.

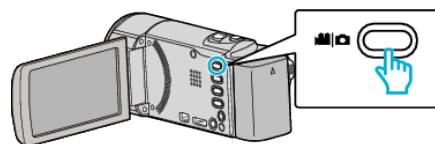

- Set the recording mode to either video or still image.
- To switch the mode between video and still image, tap video or still image on the recording screen to display the mode switching screen. Tap video or still image to switch the mode to video or still image respectively. (You can also use the video/still image button on this unit.)

2 Tap “MENU”.



- The top menu appears.

3 Tap “RECORD SETTING”.

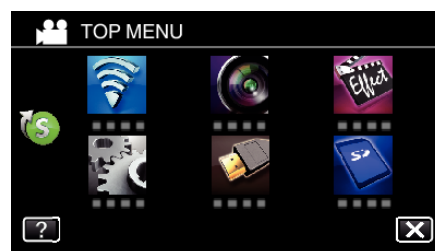

4 Tap > on the lower right of the screen.



5 Tap “PET SHOT”.



- Tap X to exit the menu.
- Tap back arrow to return to the previous screen.

6 Tap "ON".

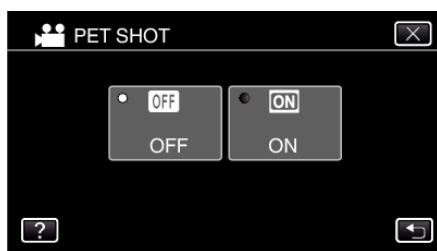

- Tap X to exit the menu as the previous screen appears.

7 Point the camera toward the pet.

- A still image is automatically captured when faces of pets are detected.

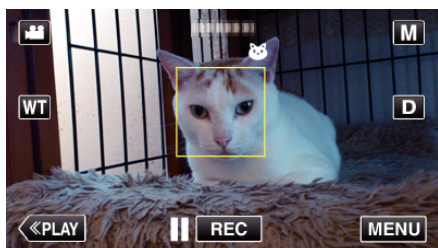

- PHOTO lights up when a still image is being captured.

Memo : _____

- The camera is able to detect up to 6 faces of pets.
- "PET SHOT" may not work properly depending on the type of pet, shooting conditions (distance, angle, brightness, etc.) and the subject (direction of face, etc.). It is also particularly difficult to detect faces of pets that are totally black, covered in long hair, or in backlight.
- Subjects other than your pet may be detected by mistake sometimes. Make use of "PET SHOT" only for pets such as dogs or cats.
- After a pet is detected and captured, it takes time before the next recording may be performed.
- "PET SHOT" does not work in the following cases:
 - when menu is being displayed
 - when remaining recording time or battery power is being displayed
 - when any functions in "SPECIAL RECORDING" is set

"Recording with Effects" (🔊 p. 40)

Caution : _____

- When "PET SHOT" is set to "ON", "TOUCH PRIORITY AE/AF" will be set to "PET TRACKING" automatically. Even when "PET SHOT" is set to "ON", if "TOUCH PRIORITY AE/AF" is not set to "PET TRACKING", "PET SHOT" will be set to "OFF" automatically.
- If appropriate results cannot be obtained, record with "PET SHOT" set to "OFF".

Registering Human Face Personal Authentication Information

By registering the face of a person beforehand, focus and brightness can be adjusted automatically by the face tracking function. Up to 6 faces, together with names and priority levels, can be registered. It is recommended to register the faces that are often being recorded by this camera beforehand.

*The following is a screen of the model with Wi-Fi functions.

1 Open the LCD monitor.

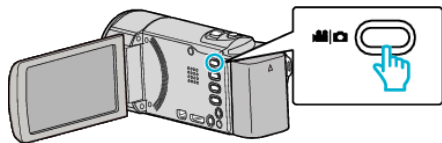

- Set the recording mode to either video or still image.
- To switch the mode between video and still image, tap or on the recording screen to display the mode switching screen. Tap or to switch the mode to video or still image respectively. (You can also use the / button on this unit.)

2 Tap "MENU".

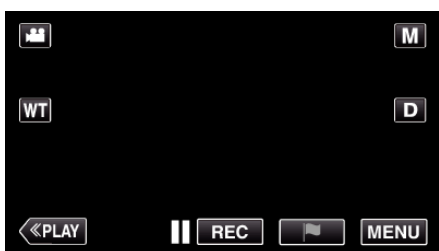

- The top menu appears.

3 Tap "SETUP".

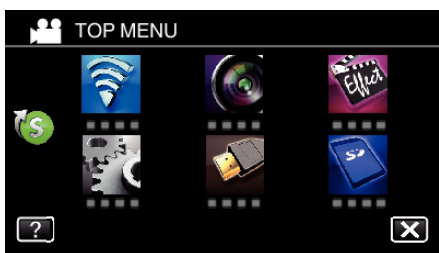

4 Tap "FACE REGISTRATION".

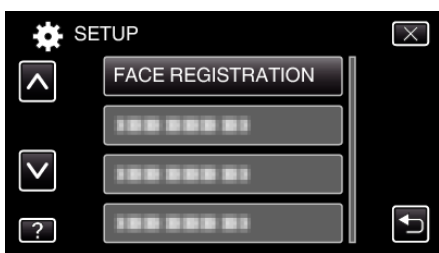

- Tap to exit the menu.
- Tap to return to the previous screen.

5 Tap "REGISTER NEW FACE".

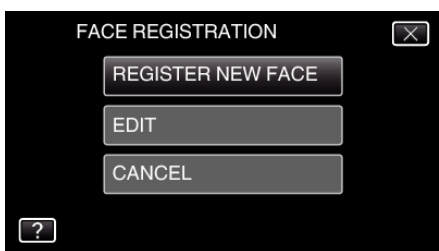

6 Point the camera toward the human subject.

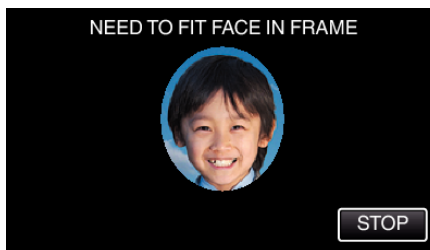

- Information is collected before face registration recording. The frame appears blinking while information is being collected.
- Adjust to fit the face within the frame while it is blinking. The frame stops blinking and lights up after information collection is complete.
- To cancel the registration, tap "STOP". When "CANCEL FACE RECOGNITION?" appears, tap "YES" to return to the normal recording mode.

7 Tap "RECORD" and record the face from the front.



- A face is captured to be used on the face registration index screen.
- Other than tapping "RECORD", you can also record by pressing the SNAPSHOT button fully.
- A sound can be heard when recording is complete.
- To cancel the registration, tap "STOP". When "CANCEL FACE RECOGNITION?" appears, tap "YES" to return to the normal recording mode.

8 Tap "YES" to continue recording.

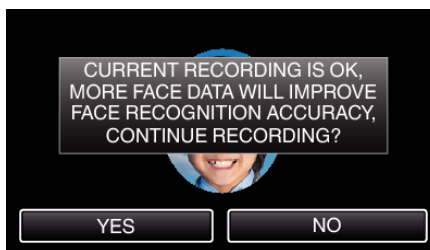

- To proceed to collect face information in the four directions of up, down, left, and right, tap "YES". It is recommended to continue recording to increase the accuracy of face recognition.
- To end face registration recording, tap "NO". Go to step 11.

9 Rotate the face slowly in four directions to register the face information.

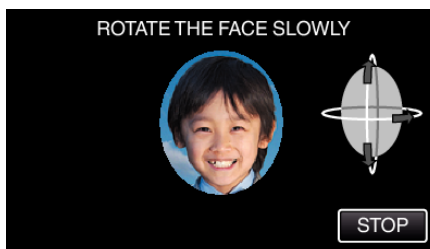

- Rotate the face slowly while looking at the camera. A sound can be heard when recording is complete for each direction. (4 times in total) Repeat the step until recording (registration) is complete for all directions.
- Registration of the four directions may fail depending on the shooting environment. In this case, tap "STOP" to cancel recording, then tap "NO" and go to step 11.
- If the face cannot be properly recognized during recording, register the face again.

10 Face the camera with a smiling face.

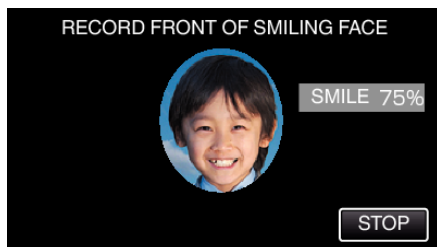

- Recording starts automatically. Using the smile % display as a reference, smile such that the value is as high as possible.
- A sound can be heard when recording is complete.
- To cancel recording of smiling face and proceed to enter a name, tap "STOP", then tap "NO" and go to step 11.

11 Tap "OK".

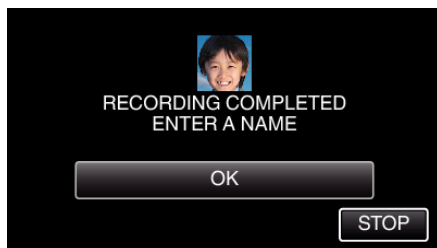

- Tapping "OK" registers the recorded face and the screen for entering a name appears.
- To cancel the registration, tap "STOP". When "CANCEL FACE RECOGNITION?" appears, tap "YES" to return to the normal recording mode.

12 Tap on the on-screen keyboard to enter a name, then tap "REG.".

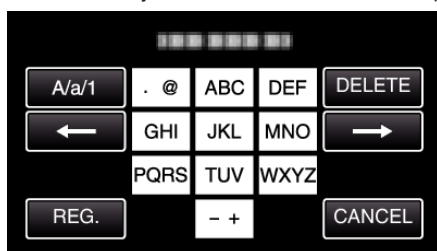

- Tap "DELETE" to delete a character.
- Tap "CANCEL" to exit.
- Tap "A/a/1" to select character input type from upper case letter, lower case letter, and number.
- Tap ← or → to move one space to the left or right.
- Up to 8 characters can be entered.
- How to input characters
Example: To enter "KEN"
Tap "JKL" 2 times → Tap "DEF" 2 times → Tap "MNO" 2 times

13 Tap the desired priority level, then tap "REG.".

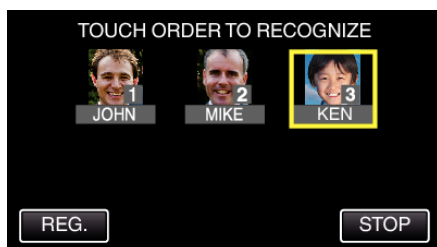

- Upon registration, the last number is assigned as the priority level. During face detection, the subject with the highest priority (lowest number) will be detected.
- You can change the priority level of a subject by tapping on the number.
Example: To change the priority level of number 3 to number 1, tap number 1. The priority level of the registered subject becomes number 1, while the priority levels of the original number 1 and the ones below drop by one place. (In this example, the original number 1 becomes number 2, and the original number 2 becomes number 3.)
- When "REG." is tapped, the registration complete screen appears.

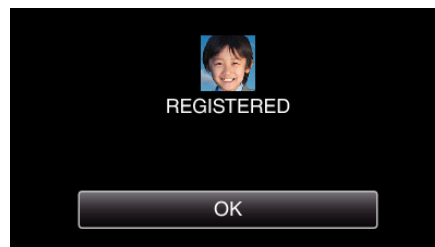

- Tap "OK" to complete the registration.
- You can edit registered face information in "EDIT".
"Editing the Registered Face Information" (p. 53)

Memo :

- Faces may not be registered correctly in the following cases:
 - when the face appears either too small or too large compared to the frame
 - when it is too dark or too bright
 - when the face appears horizontal or slanted
 - when a part of the face is hidden
 - when there are multiple faces within the frame
- To increase the accuracy of face recognition, fit only one face within the frame and register in a bright environment.
- Faces may not be recognized correctly depending on the shooting conditions and environment. In this case, register the face again.
- Faces may not be recognized correctly during recording if the face recognition level is low. In this case, register the face again.
- Face tracking and name display may not work properly depending on the registered faces, shooting conditions (distance, angle, brightness, etc.), and expressions.
- Face tracking and name display may not work properly for people with similar facial features, such as siblings, parents, children, etc.

Setting SMILE%/NAME DISPLAY

“SMILE%/NAME DISPLAY” allows you to set the items to display when faces are detected.

This item is only displayed when “TOUCH PRIORITY AE/AF” is set to “FACE TRACKING”.

“Capturing Subjects Clearly (TOUCH PRIORITY AE/AF)” (p. 46)

*The following is a screen of the model with Wi-Fi functions.

1 Open the LCD monitor.

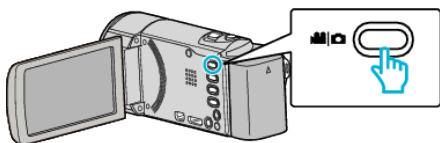

- Set the recording mode to either video or still image.
- To switch the mode between video and still image, tap or on the recording screen to display the mode switching screen. Tap or to switch the mode to video or still image respectively. (You can also use the / button on this unit.)

2 Tap “MENU”.



3 Tap “RECORD SETTING”. (Go to step 4.)
Alternatively, tap “SMILE%/NAME DISPLAY” in the shortcut menu. (Go to step 5.)

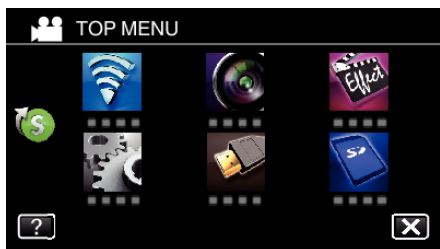

4 Tap > on the lower right of the screen.

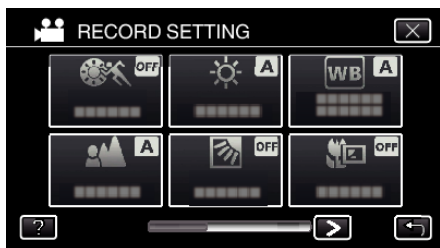

5 Tap “SMILE%/NAME DISPLAY”.



6 Tap the desired setting.

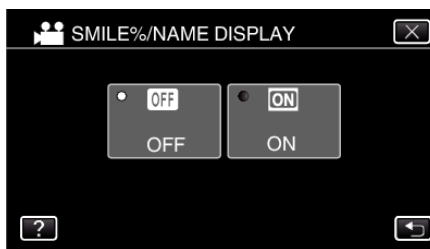

Setting	Details
OFF	Displays only the frames when faces are detected.
ON	Displays the frames, names, and smile levels (%) when faces are detected.

- Frame: Appears around detected faces.
- Name: Appears for faces that are registered.
- Smile level: Appears in value (0 % - 100 %) for detected smiles.



Memo :

- The camera is able to detect up to 16 faces. Smile levels will be displayed for up to 3 of the largest faces displayed on the screen.
 - Some faces may not be detected depending on the shooting environment.
 - You can register personal authentication information like face, name, and priority level of person before recording.
 - Up to 3 registered names will be displayed according to the priority level.
- “Registering Human Face Personal Authentication Information” (p. 50)
- “SMILE%/NAME DISPLAY” is set to “ON” when the demo mode is activated.

“DEMO MODE ” (p. 219)

Editing the Registered Face Information

You can change the name, priority level, and face information that are registered.

*The following is a screen of the model with Wi-Fi functions.

1 Tap "MENU".

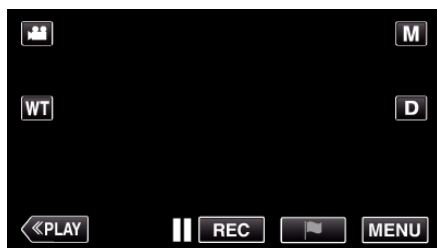

- The top menu appears.

2 Tap "SETUP".

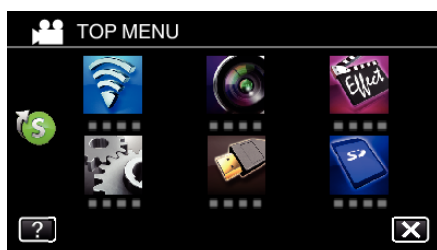

3 Tap "FACE REGISTRATION".

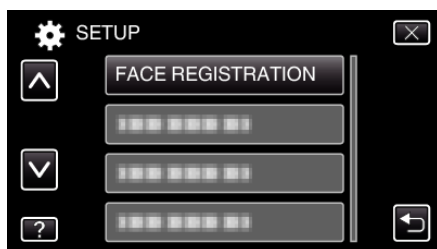

- Tap X to exit the menu.
- Tap ↶ to return to the previous screen.

4 Tap "EDIT".

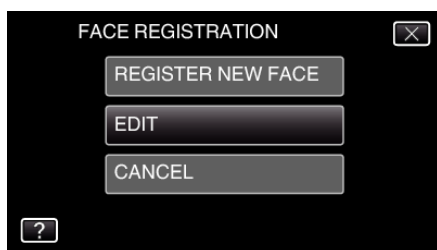

5 Tap the person to edit.

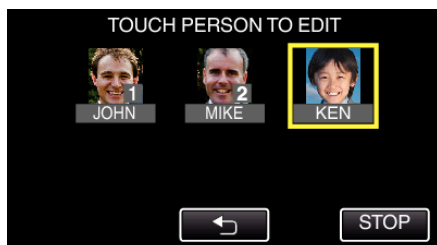

6 Tap the item to edit.

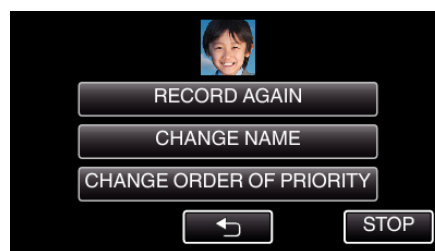

- If you select "RECORD AGAIN", proceed to step 6 in "Registering Human Face Personal Authentication Information" (p. 50).
- If you select "CHANGE NAME", proceed to step 12 in "Registering Human Face Personal Authentication Information" (p. 51).
- If you select "CHANGE ORDER OF PRIORITY", proceed to step 13 in "Registering Human Face Personal Authentication Information" (p. 51).

"Registering Human Face Personal Authentication Information" (p. 50)

Canceling (Deleting) the Registered Face Information

You can cancel (delete) the face information that is registered.

*The following is a screen of the model with Wi-Fi functions.

1 Tap "MENU".



- The top menu appears.

2 Tap "SETUP".

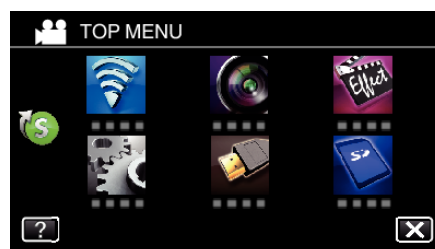

3 Tap "FACE REGISTRATION".

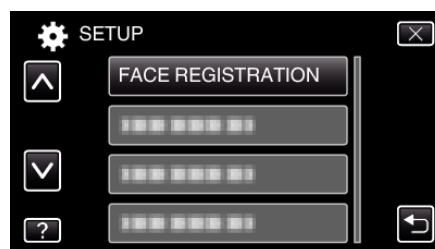

- Tap X to exit the menu.
- Tap ↶ to return to the previous screen.

4 Tap "CANCEL".

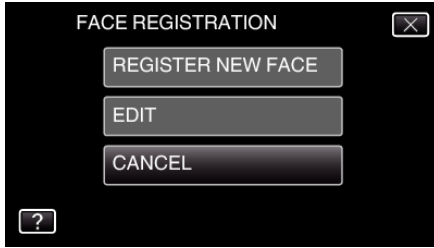

5 Tap the person to cancel registration of.

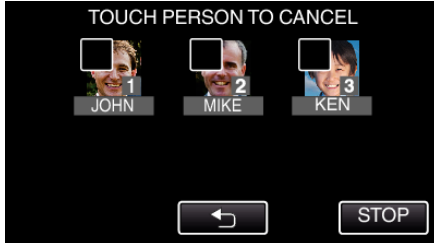

- appears on the selected person.
- To remove from a person, tap on the person again.

6 Tap "SET".

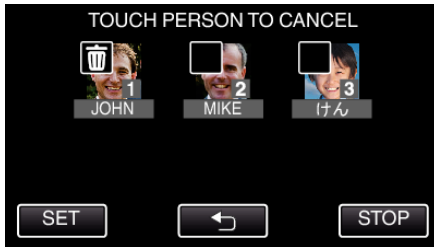

7 Tap "YES".

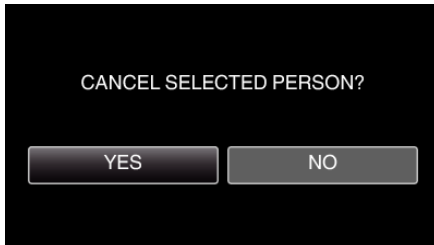

- Tap "YES" to delete the face information of the selected person.
- Tap "NO" to return to the previous screen.
- Tap "OK" when the deletion complete screen appears.

Reducing Camera Shake

When the image stabilizer is set, camera shake during video recording can be effectively reduced.

1 Open the LCD monitor.

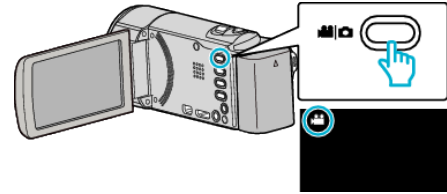

2 Press the button to change the setting.

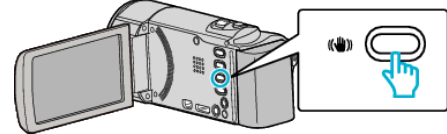

- The setting of image stabilizer changes with every press.

Setting	Details
OFF	Deactivates image stabilizer.
ON	Reduces camera shake under normal shooting conditions.
ON (AIS) video mode only	Reduces camera shake more effectively when shooting bright scenes on the wide angle end. Only on the wide angle end (approx. 5x).

Memo :

- It is recommended to set the image stabilizer to "OFF" when shooting a subject of little movement with the unit on a tripod.
- Complete stabilization may not be possible if camera shake is excessive.
- When "ON (AIS)" is set, the angle of view becomes narrower.
- Image stabilization only starts when the SNAPSHOT button is pressed halfway during still image recording.

Marking the Video While Recording

You can mark a specific scene while recording video. When a mark is made, the marked position is recorded to make it easy to find the position and start a digest playback.

- Mark function can be used only for videos recorded in AVCHD format. (Videos recorded in iFrame format is not supported.) (GZ-EX315)

1 Open the LCD monitor.

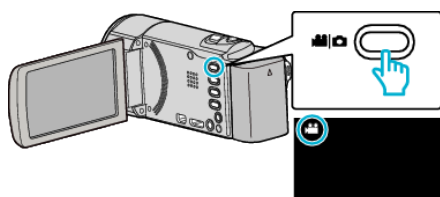

2 Start recording a video.

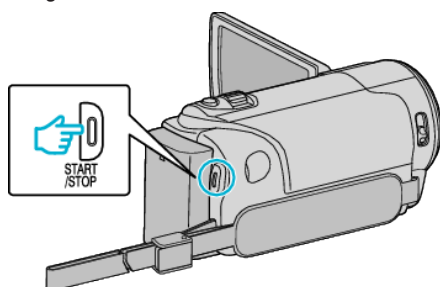

- Press the START/STOP button again to stop recording.

3 Tap the mark icon  at the scene you want to mark.

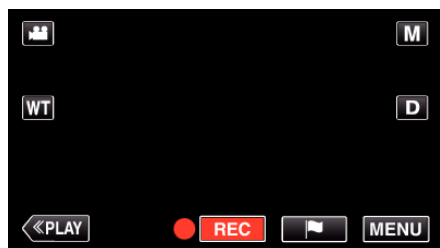

- Once a scene is marked, the next mark won't be made within 5 seconds.

4 End recording a video.

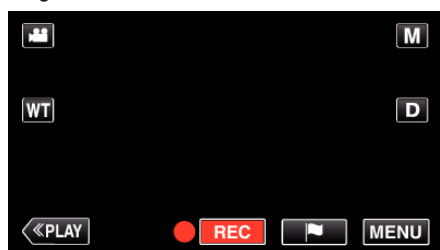

- Tap  to end the video recording.

Memo :

- Refer to the below for playing back the marked scenes.
“MARKING PLAYBACK” (p. 69)
- By installing a specialized application in your smartphone, the mark operation can be done from the smartphone. (GZ-EX315)
“Using the Markings” (p. 157)

Slow-motion (High-speed) Recording

You can record videos in slow-motion by increasing the recording speed to emphasize the movements, and play back the slow-motion video smoothly. This is a handy function for checking movements, such as golf swings. (Video file in AVCHD only)





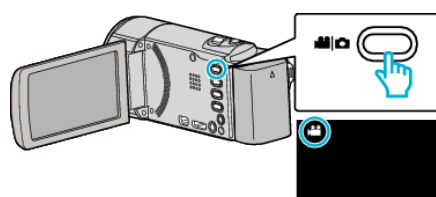

Recording Speed	250 fps
Image Size	720×576
Maximum Recording Time	144 m
Maximum Playback Time	12 h
Image Size when Connected to Monitor	1920×1080

- The playback time will be 5 times of the actual recorded time. (Example: If the recorded time is 1 minute, the playback time will be 5 minutes.)

*The following is a screen of the model with Wi-Fi functions.

1 Open the LCD monitor.



- Check if the recording mode is .
- If the mode is  still image, tap  on the recording screen to display the mode switching screen. Tap  to switch the mode to video. (You can also use the /  button on this unit.)

2 Tap “MENU”.



- The top menu appears.

3 Tap “SPECIAL RECORDING”.

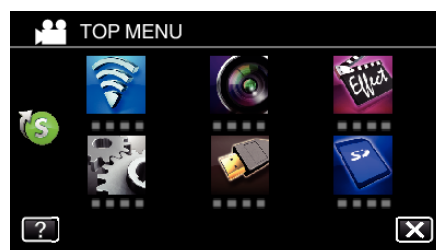

4 Tap "HIGH SPEED RECORDING".

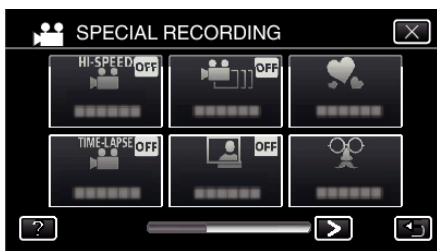

5 Tap "ON".

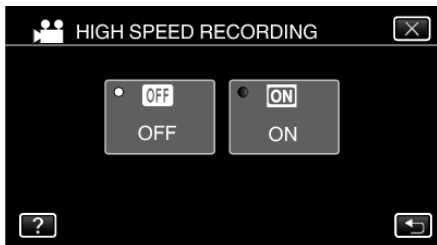

- When "ON" is tapped, 250 frames can be recorded in 1 second.
- To cancel high-speed recording, tap "OFF".

6 Start recording.

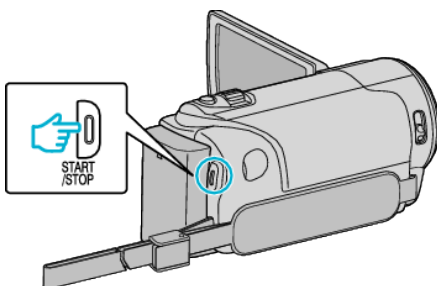

- Press the START/STOP button again to stop recording.
- Settings of high-speed recording are not saved when the power is turned off.

Memo :

- This function does not support the iFrame recording format. (GZ-EX315)
- Images may appear grainier than other videos. The image displayed on the LCD monitor during recording may also appear grainier.
- Audio sound is not recorded together with the video.
- When high-speed recording is enabled, only the optical zoom can be used.
- During high-speed recording, "TOUCH PRIORITY AE/AF" is set to "OFF". In addition, as image stabilizer is set to "OFF", it is recommended that a tripod be used, and recording be performed in a bright location with the subject magnified as much as possible.

"Tripod Mounting" (p. 23)

Recording at Intervals (TIME-LAPSE RECORDING)

This function enables the changes of a scene that occur slowly over a long period to be shown within a short time by taking frames of it at a certain interval.

This is useful for making observations such as the opening of a flower bud. (Video file in AVCHD only)

*The following is a screen of the model with Wi-Fi functions.

1 Open the LCD monitor.

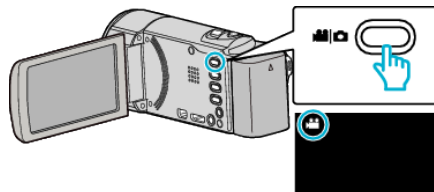

- Check if the recording mode is .
- If the mode is still image, tap on the recording screen to display the mode switching screen. Tap to switch the mode to video. (You can also use the button on this unit.)

2 Tap "MENU".



- The top menu appears.

3 Tap "SPECIAL RECORDING".

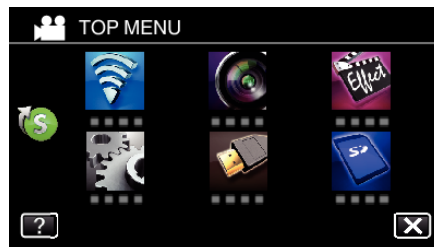

4 Tap "TIME-LAPSE RECORDING".



- Tap X to exit the menu.
- Tap to return to the previous screen.

- 5 Tap to select a recording interval (1 to 80 seconds).

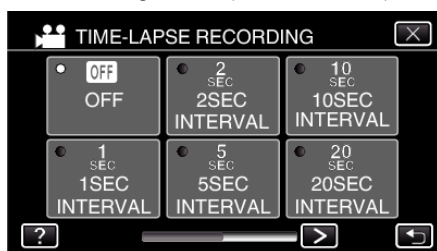

- The greater the number of seconds, the longer the recording interval.
- Tap < or > to scroll the screen.
- Tap X to exit the menu.
- Tap ↶ to return to the previous screen.

- 6 Start recording.

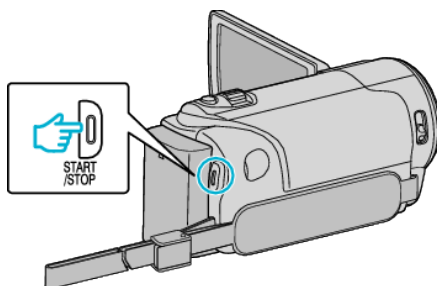

- A frame is taken at intervals of the selected period.
- When the recording interval is set to “20SEC INTERVAL” or higher, this unit switches to the power-saving mode between recordings. At the next point to record, the power-saving mode will be turned off and recording will start automatically.
- Press the START/STOP button again to stop recording.
- Settings of Time-Lapse recording are not saved when the power is turned off.

Indications During Time-Lapse Recording



	Display	Description
①	Recording interval	Displays the recording interval that is set.
②	Recorded Time	Displays the actual recorded time of the video. Recorded time increases in units of frames.
③	Actual Elapsed Time	Displays the actual elapsed time after recording starts.
④	Remaining Recording Time	Remaining time left to record with the currently selected video quality.

Time-Lapse Setting

The greater the number of seconds, the longer the recording interval.

Setting	Details
OFF	Deactivates the function.
1SEC INTERVAL	Takes a frame at 1-second intervals. Recorded videos will be played back at 25 times speed.
2SEC INTERVAL	Takes a frame at 2-second intervals. Recorded videos will be played back at 50 times speed.
5SEC INTERVAL	Takes a frame at 5-second intervals. Recorded videos will be played back at 125 times speed.
10SEC INTERVAL	Takes a frame at 10-second intervals. Recorded videos will be played back at 250 times speed.
20SEC INTERVAL	Takes a frame at 20-second intervals. Recorded videos will be played back at 500 times speed.
40SEC INTERVAL	Takes a frame at 40-second intervals. Recorded videos will be played back at 1000 times speed.
80SEC INTERVAL	Takes a frame at 80-second intervals. Recorded videos will be played back at 2000 times speed.

Caution :

- This function does not support the iFrame recording format. (GZ-EX315)
- Audio cannot be recorded during time-lapse recording.
- Zooming, simultaneous still image recording, and image stabilizer are not available in time-lapse recording.
- When recording is stopped with the recorded time less than “0:00:00:14” , the video will not be saved.

Memo :

- Settings of time-lapse recording are reset when the power is turned off. To start time-lapse recording again, it is necessary to make the selection once more.
- Recording stops automatically 99 hours after it is started.
- Make use of a tripod and AC adapter for time-lapse recordings with long intervals. It is also recommended to fix the focus and white balance manually.

“Tripod Mounting” (☞ p. 23)

“Adjusting Focus Manually” (☞ p. 35)

“Setting White Balance” (☞ p. 38)

Recording Stop-Motion Videos (STOP-MOTION REC)

By pressing the SNAPSHOT button, 2 frames of still images are recorded, and stop-motion videos are created by piecing these images together.
(Video files in AVCHD only)

*The following is a screen of the model with Wi-Fi functions.

1 Open the LCD monitor.

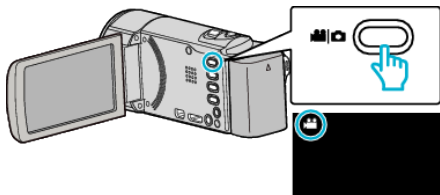

- Check if the recording mode is .
- If the mode is still image, tap on the recording screen to display the mode switching screen. Tap to switch the mode to video. (You can also use the button on this unit.)

2 Tap "MENU".



- The top menu appears.

3 Tap "SPECIAL RECORDING".

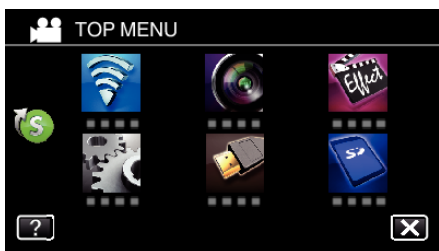

4 Tap "STOP-MOTION REC".

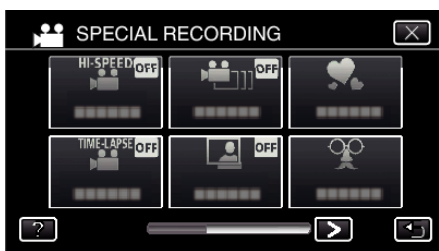

5 Tap "ON".

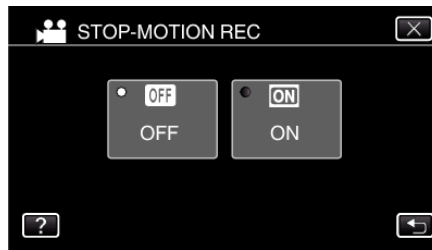

- The "STOP-MOTION RECORDING MODE. PRESS SNAPSHOT TO CAPTURE FRAME" appears.

6 Press the SNAPSHOT button to start recording.

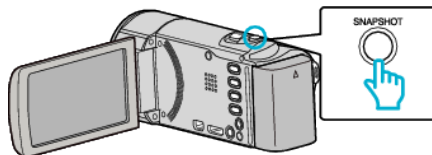

- Tap still image recording () to start recording.
- Press the START/STOP button or tap to stop recording.
- "CAPTURE" lights up when a scene is recorded.
- Settings of the Stop-Motion video are not saved when the power is turned off.

Caution :

- Audio cannot be recorded during "STOP-MOTION REC".
- This function does not support the iFrame recording format.
- When recording is stopped with the recorded time less than "0:00:00:14" (or less than 7 snapshots), the video will not be saved.
- Simultaneous still image recording and image stabilizer are not available during "STOP-MOTION REC".
- When "STOP-MOTION REC" is set, the power-saving mode is deactivated.
- "TOUCH PRIORITY AE/AF", "SMILE SHOT", "PET SHOT" and "AUTO REC" are not available.

Recording Automatically by Sensing Movements (AUTO REC)

This function enables the unit to record automatically by sensing the changes in subject's movement (brightness) within the red frame displayed on the LCD monitor.

It can be set for both video and still image modes.

*The following is a screen of the model with Wi-Fi functions.

- 1 Open the LCD monitor.

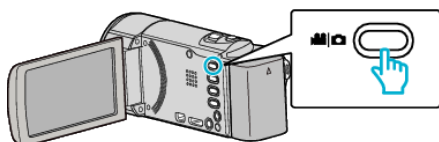

- Set the recording mode to either video or still image.
- To switch the mode between video and still image, tap or on the recording screen to display the mode switching screen. Tap or to switch the mode to video or still image respectively. (You can also use the / button on this unit.)

- 2 Compose the picture according to the subject.

- Adjust the angle of view with the zoom, etc.

- 3 Tap "MENU".



- The top menu appears.

- 4 Tap "SPECIAL RECORDING".

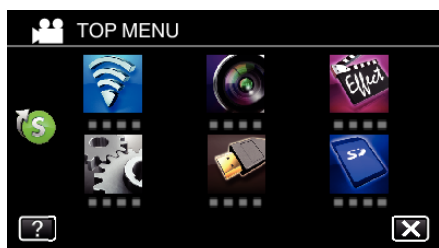

- 5 Tap "AUTO REC".

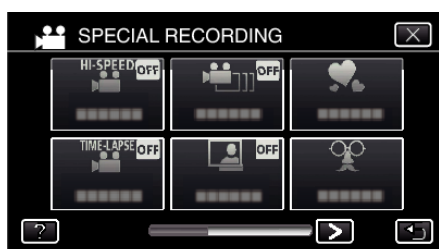

- Tap X to exit the menu.
- Tap to return to the previous screen.

- 6 Tap "ON".

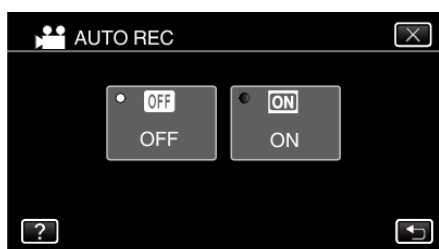

- 7 Recording starts automatically when the subject within the red frame moves.

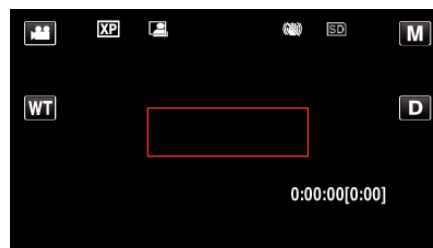

- A red frame appears 2 seconds after the menu display disappears.
- For video recording, recording continues while there are still movements of the subject (changes in brightness) within the red frame. When there are no more movements of the subject (changes in brightness) within the red frame, recording will stop in 5 seconds.
- To stop video recording manually, press the START/STOP button. However, as the "AUTO REC" setting remains at "ON" even after the video recording is stopped, recording starts again when movements of the subject (changes in brightness) are detected within the red frame. To cancel "AUTO REC", set it to "OFF".

Caution :

- Digital zoom, image stabilizer, self-timer, and continuous shooting are not available after "AUTO REC" is set.
- "AUTO REC" cannot be used together with "TIME-LAPSE RECORDING". When both are set, priority is given to "TIME-LAPSE RECORDING".
- "IMAGE SIZE" cannot be changed after "AUTO REC" is selected. Set it before selecting "AUTO REC".
- The auto power off and power-saving modes are not available after "AUTO REC" is set.

Memo :

- Recording stops when there are no changes for 5 seconds during video recording.
- Settings of "AUTO REC" are not saved when the power is turned off.
- Recording may not start when the movements of the subject within the red frame are too fast or the changes in brightness are too small.
- Recording may start due to changes in brightness even if there is no movement within the red frame.
- While zooming, recording cannot be started.

Taking Group Shots (Self-timer)

The 10-second self-timer and Face Detection self-timer are convenient functions for taking group photos. The 2-second self-timer is useful for preventing camera shake caused by pressing the shutter button.

*The following is a screen of the model with Wi-Fi functions.

Memo :

When shooting a photo using the self-timer function, use of a tripod is recommended.

“Tripod Mounting” (p. 23)

Using the 2-/10-second Self-timer

1 Open the LCD monitor.

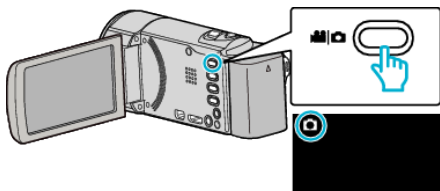

- Check if the recording mode is .
- If the mode is video, tap on the recording screen to display the mode switching screen. Tap to switch the mode to still image. (You can also use the button on this unit.)

2 Tap “MENU”.

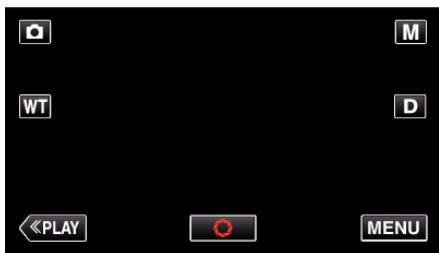

- The top menu appears.

3 Tap “RECORD SETTING”.

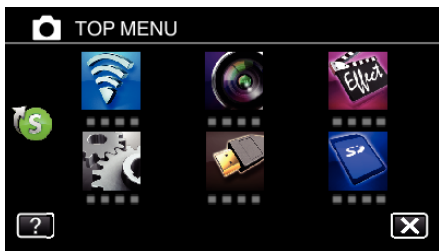

4 Tap > on the lower right of the screen.

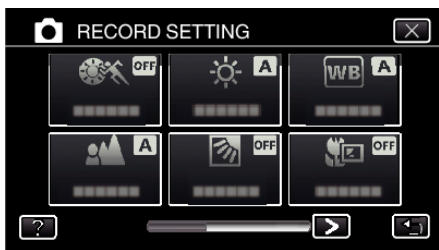

5 Tap “SELF-TIMER”.



- Tap X to exit the menu.
- Tap to return to the previous screen.

6 Tap “2SEC” or “10SEC”.

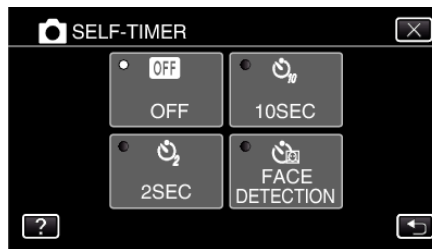

7 Set the focus on the subject.

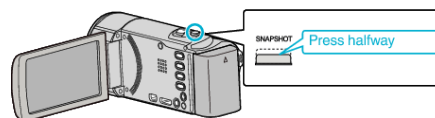

- When focused, the focus icon lights up in green.

8 Take a still image.

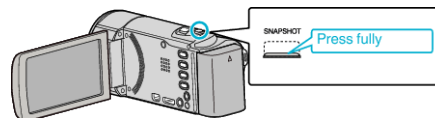

- A timer appears and countdown to shooting starts.
- To stop the self-timer, press the SNAPSHOT button again.

Using the Face Detection Self-timer

Pressing the SNAPSHOT button starts face detection, and shooting is performed three seconds after another person enters the frame. This function is useful when you want to include the photographer in the group photo.

- 1 Open the LCD monitor and select the still image mode.

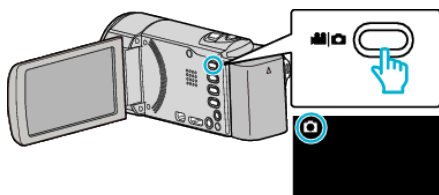

- The still image mode icon appears.

- 2 Tap "MENU".

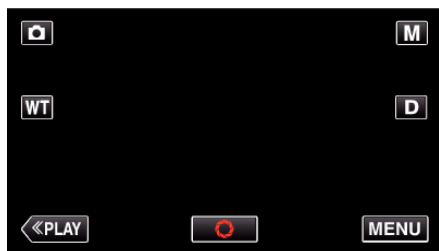

- The top menu appears.

- 3 Tap "RECORD SETTING".

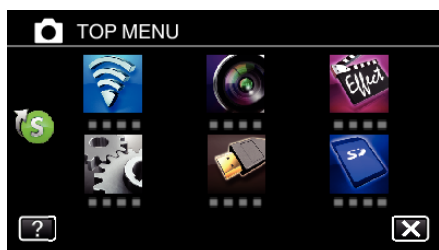

- 4 Tap > on the lower right of the screen.

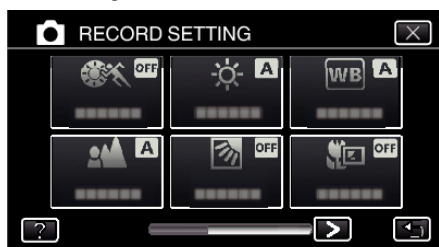

- 5 Tap "SELF-TIMER".



- Tap X to exit the menu.
- Tap ↶ to return to the previous screen.

- 6 Tap "FACE DETECTION".

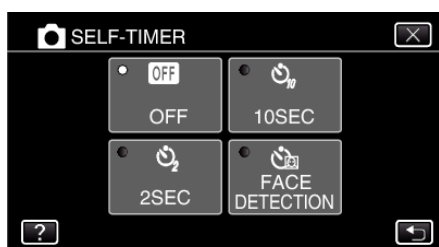

- 7 After making sure that everyone is facing the camera, press the SNAPSHOT button.

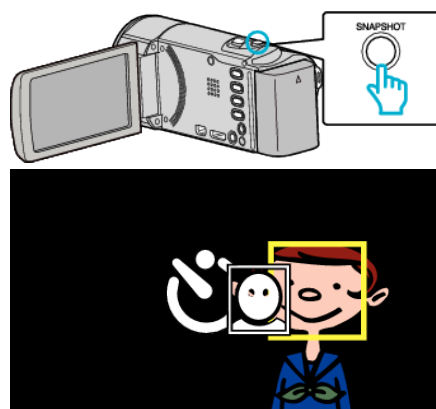

- Frames appear around the faces of the subjects.
- Pressing the SNAPSHOT button again starts the 10-second self-timer.

- 8 The photographer enters the frame.

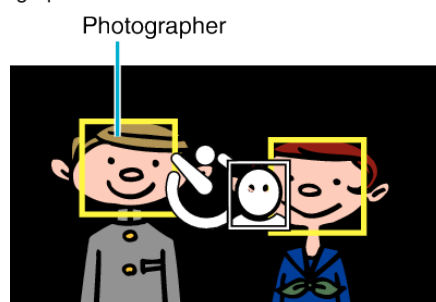

- The shutter is released 3 seconds after the photographer enters the frame.
- To stop the self-timer, press the SNAPSHOT button again.

Memo :

- The "FACE DETECTION" function may fail to detect faces depending on the shooting environment.

Recording Videos with Date and Time

You can record videos together with the date and time. Set this when you want to save the file with date and time display. (The date and time cannot be deleted after recording.)

*The following is a screen of the model with Wi-Fi functions.

1 Open the LCD monitor.

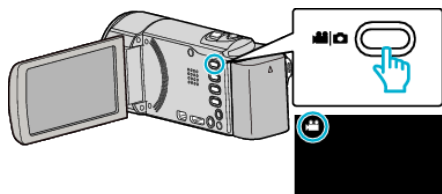

- Check if the recording mode is .
- If the mode is still image, tap on the recording screen to display the mode switching screen. Tap to switch the mode to video. (You can also use the / button on this unit.)

2 Tap "MENU".

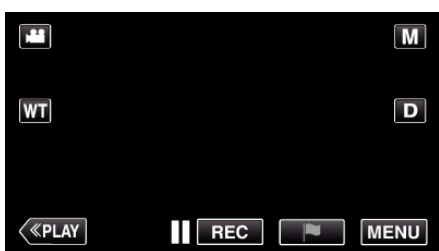

- The top menu appears.

3 Tap "SPECIAL RECORDING".

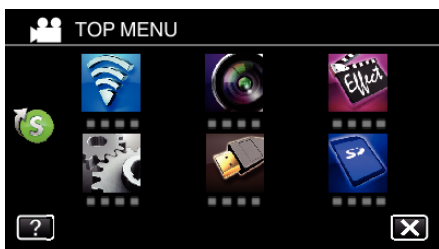

4 Tap > on the lower right of the screen.

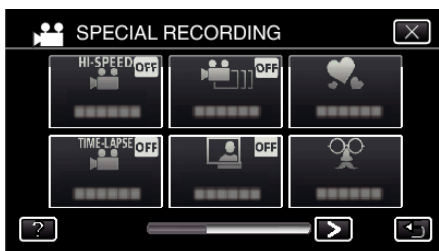

5 Tap "DATE/TIME RECORDING".



- Tap X to exit the menu.
- Tap to return to the previous screen.

6 Select the type if the clock with < or >, and tap "SET".



- When "SET" is tapped, the precaution for date/time recording appears.
- Tap X to exit the menu.

7 Adjust the display position of the date and time display with a finger mark by touching it with your finger and dragging it.

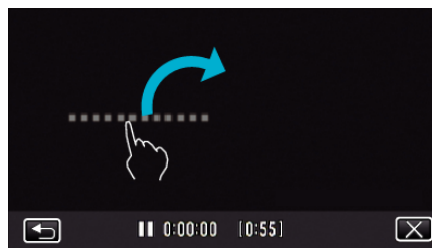

- Move the date and time display while touching it with your finger and tracing it on a screen.

8 Press the START/STOP button to start recording.

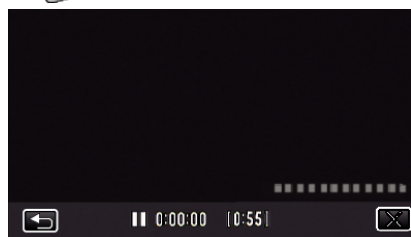
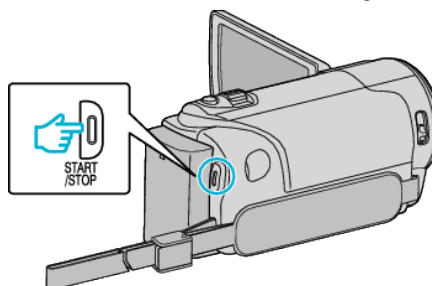

- Press the START/STOP button again to stop recording.
- Tap to return to the screen for selecting the types of clock.
- Tap X to exit "DATE/TIME RECORDING". (To perform operations other than recording, tap X to cancel the "DATE/TIME RECORDING" first.)

Caution :

- The date and time cannot be deleted after recording.

Checking the Remaining Recording Time

You can check the remaining recording time on the SD card as well as the remaining battery power.

- 1 Open the LCD monitor.

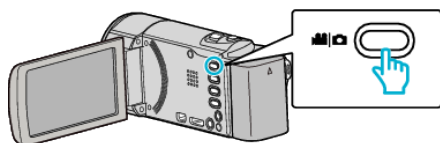

- Set the recording mode to either video or still image.
- To switch the mode between video and still image, tap or on the recording screen to display the mode switching screen. Tap or to switch the mode to video or still image respectively.

- 2 Press the INFO button.

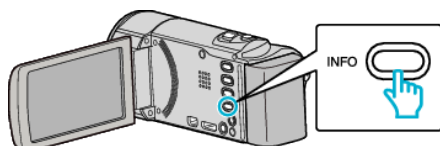

- If in the still image mode, go directly to step 4.

- 3 Display the remaining recording time.



- The remaining recording time is displayed only in the video recording mode.
- Press the INFO button to check the remaining recording time of each recording media.
- To display the remaining battery power, tap .
- will not be displayed when the AC adapter is connected.
- Tap to return to the recording mode.
- To exit the display, tap .

- 4 Display the remaining battery power.

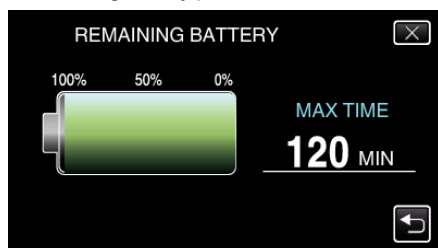

- For video recording, tap to return to the remaining recording time display. For still image recording, tap to return to the recording mode.
- To exit the display, press the INFO button or tap .
- Remaining battery power will not be displayed when the AC adapter is connected.

Memo :

- You can change to the desired video quality by tapping on it from the remaining recording time display.

Approximate Video Recording Time

Picture quality	SDHC/SDXC card						
	4GB	8GB	16GB	32GB	48GB	64GB	128GB
UXP	20 m	40 m	1 h 20 m	2 h 50 m	4 h 10 m	5 h 40 m	11 h 30 m
XP	30 m	1 h	2 h	4 h	6 h	8 h 10 m	16 h 20 m
SP	40 m	1 h 20 m	2 h 50 m	5 h 50 m	8 h 30 m	11 h 30 m	23 h 10 m
EP	1 h 40 m	3 h 30 m	7 h 10 m	14 h 40 m	21 h 30 m	28 h 50 m	57 h 50 m
SSW	1 h 20 m	2 h 40 m	5 h 30 m	11 h 20 m	16 h 40 m	22 h 20 m	44 h 50 m
SEW	2 h 50 m	5 h 40 m	11 h 30 m	23 h 30 m	34 h 30 m	46 h 10 m	92 h 40 m
iFrame (1280x720) * (GZ-EX315)	10 m	30 m	1 h	2 h	3 h	4 h	8 h
iFrame (960x540) * (GZ-EX315)	15 m	40 m	1 h 10 m	2 h 40 m	3 h 50 m	5 h 10 m	10 h 30 m

* GZ-EX315 only

- The actual recording time may shorten depending on the shooting environment.

Approximate Number of Still Images (Unit: Number of Shots)

Image size	SDHC/SDXC card				
	4GB	8GB	16GB	32GB	64GB
3840X2160(8M)(16:9)	800	1600	3200	6600	9999
1920x1080(2M)(16:9)	3100	6500	9999	9999	9999
1440x1080(1.5M)(4:3)	4200	8500	9999	9999	9999
640x480(0.3M)(4:3)	9999	9999	9999	9999	9999

- Still images that are captured during video recording or video playback are saved at a size of 1920 x 1080.

Approximate Recording Time (Using Battery)

■ GZ-EX315

Battery Pack	Actual recording time	Continuous recording time (Maximum Recording Time)
BN-VG114E (Supplied)	1 h 5 m	1 h 55 m
BN-VG121E	1 h 40 m	3 h 5 m
BN-VG138E	3 h	5 h 30 m

■ GZ-E307/GZ-E305

Battery Pack	Actual recording time	Continuous recording time (Maximum Recording Time)
BN-VG108E (Supplied) (Supplied: GZ-E305)	40 m	1 h 5 m
BN-VG114E (Supplied: GZ-E307)	1 h 15 m	2 h 10 m
BN-VG121E	1 h 55 m	3 h 15 m
BN-VG138E	3 h 20 m	5 h 45 m

- The above are values when "LIGHT" is set to "OFF" and "MONITOR BRIGHTNESS" is set to "3" (standard).
- The actual recording time is an estimate in case that such operations as zooming is used or recording is stopped repeatedly. It may be shorter in the actual usage. (It is recommended to prepare battery packs ready for three times the expected recording time.)
- Recording time may differ depending on the shooting environment and usage.
- When the battery life is reached, the recording time becomes shorter even if the battery pack is fully charged. (Replace the battery pack with a new one.)

Playing Back Videos

The followings are the types of playback that can be performed by this unit.

Item	Description
Normal Playback	Plays back the recorded videos.
Mark Playback (Mark playback/game playback)	<p>The scenes marked while recording the video and the scoring scenes recorded in the game recording mode (by using the smartphone application) can be searched.</p> <p>Also, marked scenes and goal scenes can be extracted for playback; extracted scenes can be saved as a playlist.</p> <p>To start, tap  on the playback screen.</p> <p>For the game recording mode, refer to the game score settings. (GZ-EX315) “Game Score Settings” (p. 168)</p>
DIGEST PLAYBACK	<p>From the recorded video, scenes with a smile detected, scenes with a person whose face is registered, and scenes that are marked manually are extracted and pieced together for a digest playback.</p> <p>When “AUTO” is selected, recorded video is digested in the pre-set length of time.</p> <p>Start the playback from “DIGEST PLAYBACK” in the “PLAYBACK SETTING” menu.</p>
PLAYBACK PLAYLIST	<p>Plays back the playlists that you have created.</p> <p>Start the playback from “PLAYBACK PLAYLIST” in the “PLAYBACK SETTING” menu.</p>

Switching to the video playback screen

1 Open the LCD monitor.

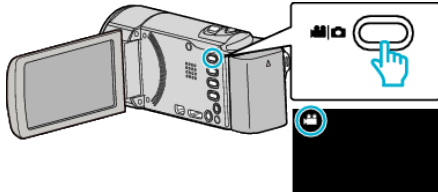

- Check if the recording mode is .
- If the mode is still image, tap on the recording screen to display the mode switching screen. Tap to switch the mode to video. (You can also use the button on this unit.)

2 Tap “<<PLAY” to select the playback mode.



3 The video playback screen is displayed.



Caution :

- Make a backup of important recorded data.
It is recommended to copy your important recorded data to a DVD or other recording media for storage.
- This unit is a microcomputer-controlled device. Electrostatic discharge, external noise and interference (from a TV, a radio, etc.) might prevent it from functioning properly. In such a case, turn off the power, then remove the AC adapter and battery pack. This unit will be reset.
- Disclaimer
 - We shall not be held responsible for loss of recorded contents when recording videos/audio or playback cannot be operated due to malfunctions in this unit, provided parts, or SD card.
 - Once deleted, recorded contents (data), including data loss due to malfunctions in this unit, cannot be restored. Please be forewarned.
 - JVC will not be responsible for any lost data.
 - In order for quality improvement, defective recording medium is subject to be analyzed. Therefore, it may not be returned.

Checking the Recording Date and Other Information

You can display the recording date and duration of the selected file.

1 Pause the playback and press the INFO button.

- To return to the playback screen, press the INFO button or tap X.

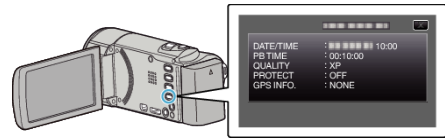





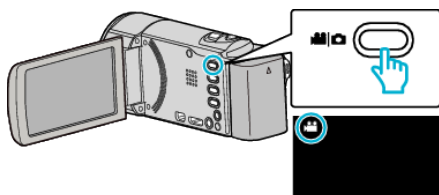

Normal Playback

Plays back the recorded videos.

*The following is a screen of the model with Wi-Fi functions.

1 Open the LCD monitor.





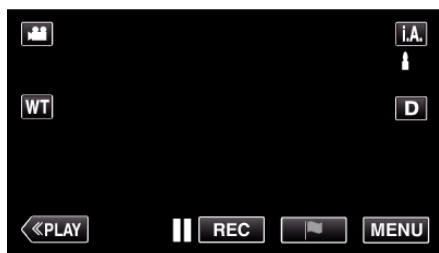

- Check if the recording mode is .
- If the mode is , tap  on the recording screen to display the mode switching screen. Tap  to switch the mode to video. (You can also use the  button on this unit.)

2 Tap “<<PLAY” to select the playback mode.

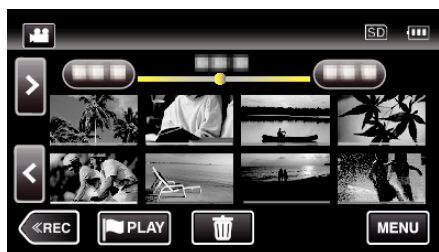

3 Tap on the file to start playback.





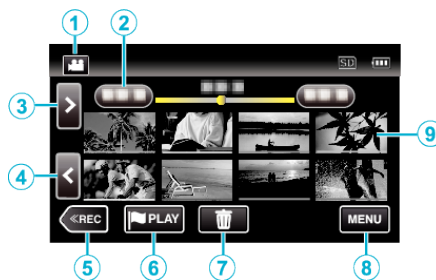

- Tap  to pause.
- Tap  to return to the index screen.
-  appears on the last image played back.
- Lines in different colors are displayed under the thumbnail display to distinguish the recording date.

Operation Buttons for Video Playback

During Index Screen Display



	Display	Description
①	Video/Still Image Mode  	Switches between video and still image modes.
②	Date	Moves to the previous/next date
③	>	Displays the next index screen (thumbnail display) • You can perform the same operation with the zoom lever.
④	<	Displays the previous index screen (thumbnail display) • You can perform the same operation with the zoom lever.
⑤	<<REC	Switches to the recording mode.
⑥		Moves to the mark playback mode. “MARKING PLAYBACK” (p. 69)
⑦		Displays the index screen (thumbnail display) to perform deletion
⑧	MENU	Displays the menu screen
⑨	Thumbnail (File)	Tap on thumbnail - Starts playback Drag to right - Scrolls to the right to show the previous index screen (thumbnail display) Drag to left - Scrolls to the left to show the next index screen (thumbnail display) Images with the same underlined color indicates the same recording date.

During Video Playback

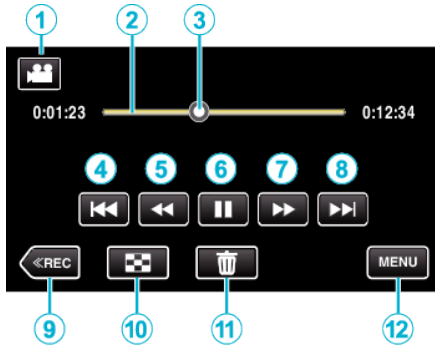

- Operations buttons on the touch screen disappear if the unit is not operated for about 5 seconds. Tap on the screen to display the operation buttons again.

	Display	Description
①	Video/Still Image Mode 	Switches between video and still image modes.
②	Timeline Bar	Tap on a random position - Moves to the tapped position Drag playback point to the left or right - Starts playback from the new position Tap on a random position - Moves to the tapped position
③	Pointer	Displays the current estimated playback position within the scene
④		Returns to the beginning of the scene Returns to the previous scene if tapped at the beginning of a scene. • Allows the same functions as the zoom lever to be performs while pausing playback.
⑤		Reverse search (speed increases with each tap)
⑤		Reverse slow-motion / Press and hold to start reverse slow playback
⑥		Playback/pause
⑦		Forward search (speed increases with each tap)
⑦		Forward slow-motion / Press and hold to start slow playback
⑧		Advances to the next scene • Allows the same functions as the zoom lever to be performs while pausing playback.
⑨	<<REC	Switches to the recording mode.
⑩		Stop (returns to index screen)
⑪		Deletes the currently displayed video.
⑫	MENU	Displays the menu screen

Memo :

- Tap or drag on the operation area of the touch screen.
- You can search for a specific file by the recording date.
“Searching for a Specific Video/Still Image by Date” (☞ p. 78)
- The recording date and time can be displayed on the screen during playback.
“DISPLAY DATE/TIME” (☞ p. 214)
- Displays the approximate remaining battery power during use.

Adjusting the Volume of Videos

You can use the zoom/volume lever to control the volume.



MARKING PLAYBACK

- The scenes marked while recording the video and the scoring scenes recorded in the game recording mode (by using the smartphone application) can be searched. Also, marked scenes and goal scenes can be extracted for playback; extracted scenes can be saved as a playlist.
- Switch to the mark playback mode by tapping **PLAY** on the video playback screen.

*The following is a screen of the model with Wi-Fi functions.

1 Open the LCD monitor.

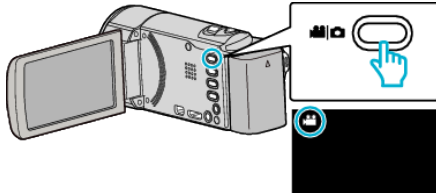

- If the mode is still image, tap **PLAY** on the recording screen to display the mode switching screen. Tap **VIDEO** to switch the mode to video. (You can also use the **VIDEO** button on this unit.)

2 Tap “<<PLAY” to select the playback mode.



3 Tap **PLAY** to open the mark playback mode.



4 Tap “DIGEST” to select the DIGEST/Mark Playback mode.



- When the thumbnail display is tapped directly (without tapping the “DIGEST” button), normal playback (additional marks can be added) starts.
 - Tap “SET” to adjust the playback time per scene and the playback position.
- “GAME PLAYBACK (GZ-EX315)” (p. 70)
 “Adjusting the Marked Playback Position” (p. 72)

5 Select the recording date of the video that you want to playback.

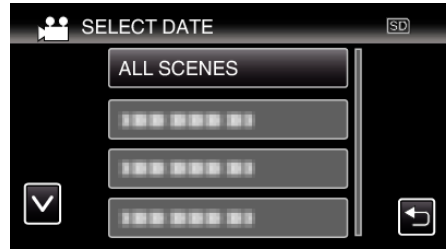

- Tap “ALL SCENES” to playback all scenes.

6 Select the type of the “MARK”.

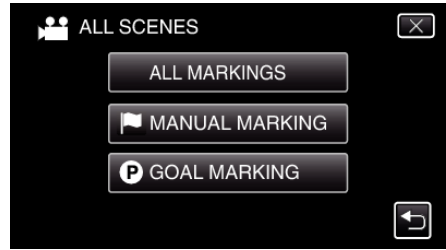

7 Digest Playback starts.

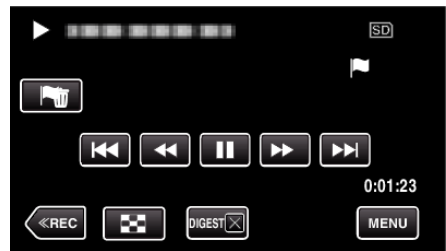

8 Digest playback stops automatically, or display the next screen by tapping “MENU”.

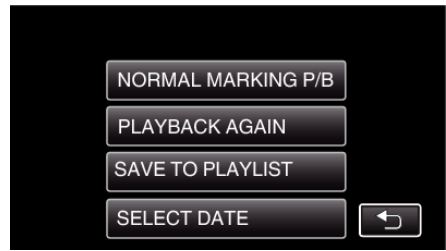

- NORMAL MARKING P/B: start normal marking playback.
- PLAYBACK AGAIN: start the digest playback again.
- SAVE TO PLAYLIST: save the digest playback images to the playlist. “PLAYBACK PLAYLIST” (p. 74)
- SELECT DATE: return to step 5.

Indications during the Marking Playback

During the Normal Marking Playback

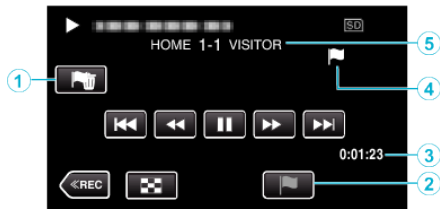

Display	Description
① Mark Delete button	Deletes the mark that is currently displayed.
② Playback Mark Button	Enter a mark while playback is in progress.
③ Elapsed Time	Displayed the playback time of the video.
④ "P" icon displayed	Indicates that the current scene is marked. Indicates that recording of the score is in progress.
⑤ Score (GZ-EX315)	Displays the score of the game (displayed only if the score is registered.)

During the DIGEST/Mark Playback



Display	Description
① Date and time display	-
② Mark Delete button	Deletes the mark that is currently displayed.
③ DIGEST Playback Cancel Button	Moves to the normal mark playback.
④ Elapsed Time	Displayed the playback time of the video.
⑤ "P" icon displayed	Indicates that the current scene is marked. Indicates that recording of the score is in progress.
⑥ Score (GZ-EX315)	Displays the score of the game (displayed only if the score is registered.)

Memo :

- Once a scene is marked, the next mark won't be made within 5 seconds.

GAME PLAYBACK (GZ-EX315)

- Game playback is a function to playback the goal scenes and/or marked scene that is recorded by the smartphone application Everio sync.
- To start, tap **PLAY** on the playback screen.
- For the game recording mode, refer to "Game Score Settings" (p. 168).

1 Open the LCD monitor.

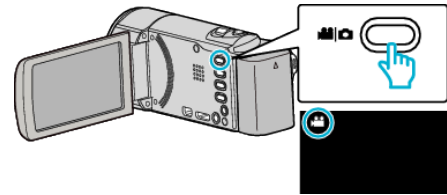

- If the mode is still image, tap **REC** on the recording screen to display the mode switching screen. Tap **PLAY** to switch the mode to video. (You can also use the **PLAY** button on this unit.)

2 Tap "<<PLAY" to select the playback mode.

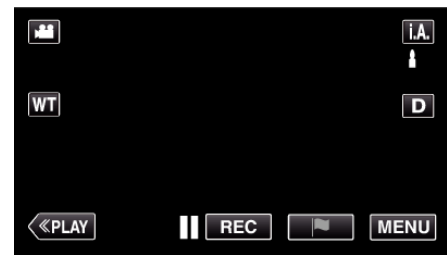

3 Tap **PLAY** to open the mark playback mode.



4 Tap "GAME" to select the game playback mode.



5 Tap the recorded game.

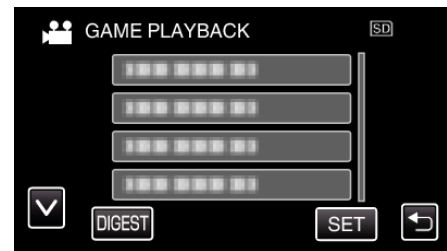

- Tap the list of the game to playback all the scenes of the game.
- Tap DIGEST to extract the score and marked scenes from the game, and to start a DIGEST playback.

6 Marked scenes are played back automatically.



- Playback stops after all the scenes are played back.
- Tap DIGESTX during DIGEST playback to exit the Mark/DIGEST playback and to switch to the normal mark playback.

Memo : _____
 • Once a scene is marked, the next mark won't be made within 5 seconds.

Indications during the Game Playback

■ During the Normal Game Playback

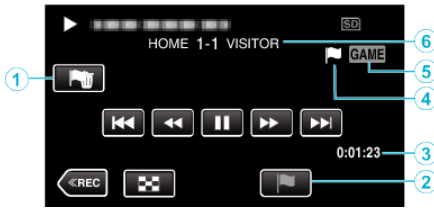

	Display	Description
①	Mark Delete button	Deletes the mark that is currently displayed.
②	Playback Mark Button	Enter a mark while playback is in progress.
③	Recorded time	Displays the time that the video is recorded.
④	“P” icon displayed “P” icon displayed	Indicates that the current scene is marked. Indicates that recording of the score is in progress.
⑤	Game playback mode	Indicates that the game playback is in progress.
⑥	Score	Displays the score of the game (displayed only if the score is registered.)

■ During the DIGEST/Game Playback



	Display	Description
①	Date and time display	-
②	Mark Delete button	Deletes the mark that is currently displayed.
③	DIGEST Playback Cancel Button	Moves to the normal mark playback.
④	Recorded time	Displays the time that the video is recorded.
⑤	“P” icon displayed “P” icon displayed	Indicates that the current scene is marked. Indicates that recording of the score is in progress.
⑥	Game playback mode	Indicates that the game playback is in progress.
⑦	Score	Displays the score of the game (displayed only if the score is registered.)

Adjusting the Marked Playback Position

Specify the length of time before and after the marked position for playing back the marked video. The maximum length of playback time per mark is 20 seconds.

*The following is a screen of the model with Wi-Fi functions.

- 1 Open the LCD monitor.

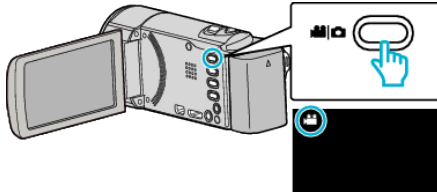

- If the mode is still image, tap on the recording screen to display the mode switching screen. Tap to switch the mode to video. (You can also use the button on this unit.)

- 2 Tap “<<PLAY” to select the playback mode.



- 3 Tap to open the mark playback mode.



- 4 Tap “SET”.



- 5 Select the items for setting.

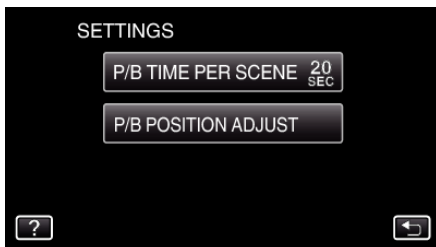

- Proceed to Step 6 if “P/B TIME PER SCENE” is selected, and proceed to Step 7 if “P/B POSITION ADJUST” is selected.

- 6 Select the playback time per scene.



- Tap to return to the previous screen.

- 7 Adjust the playback position.

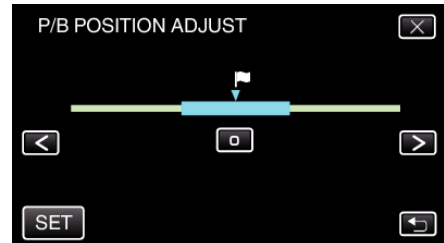

- Shift the playback position back and forth. Playback time that is set in step 6 is unchanged.
- Adjust by using < or >, then tap “SET”.
- Tap to return to the previous screen.
- Tap X to exit the menu.

DIGEST PLAYBACK

You can play back a digest of the recorded videos (Digest Playback). This is useful for checking the content of the videos quickly.

1 Open the LCD monitor.

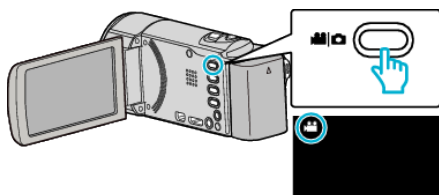

- Check if the recording mode is .
- If the mode is still image, tap on the recording screen to display the mode switching screen. Tap to switch the mode to video. (You can also use the button on this unit.)

2 Tap “<<PLAY” to select the playback mode.

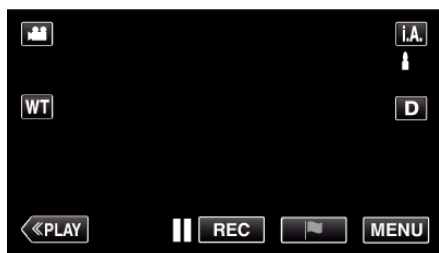

3 Tap “MENU”.

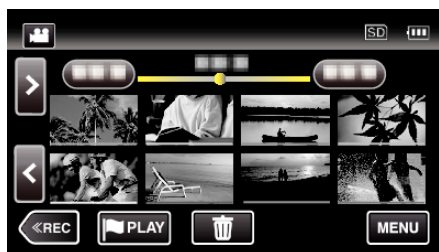

4 Tap “PLAYBACK SETTING”.



5 Tap “DIGEST PLAYBACK”.

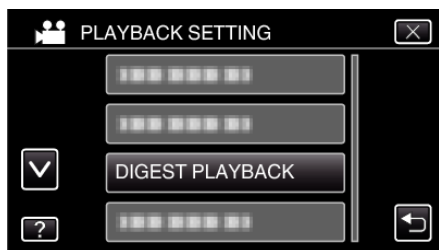

6 Tap to select a date for Digest Playback.

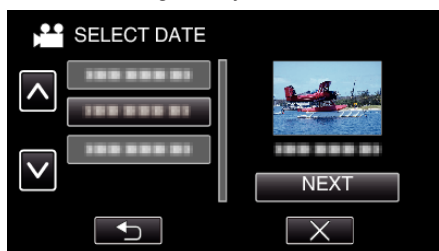

- After selecting a date, tap “NEXT”.

- When “ALL” is tapped, Digest Playback will be performed for all the dates.
- Tap X to exit the menu.
- Tap to return to the previous screen.

7 Tap to select a scene for Digest Playback.

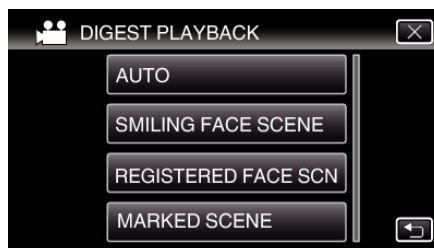

- Error message is displayed if no scene is found. Select another scene, or tap “AUTO”.

8 Select the Digest Playback time

(Only when “AUTO” is selected in Step 7)



- The time display of Digest Playback varies according to the recording time.
- When it takes time (more than 2 seconds) for “DIGEST PLAYBACK” to start after selecting Digest Playback time, a progress status will be displayed.
- The Digest Playback time is only a guide.

9 Digest Playback starts.

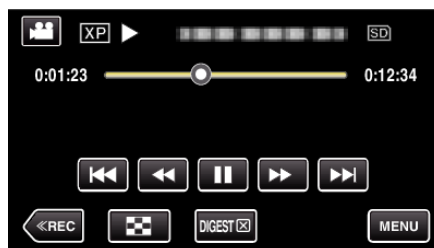

- Tap to pause.
- Tap to return to the index screen.
- Tap “DIGESTX” to return to the normal playback screen.
- Operations During Video Playback
“Operation Buttons for Video Playback” (p. 67)

10 Digest playback stops automatically, or display the next screen by tapping “MENU”.

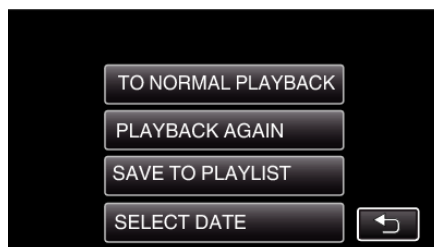

- TO NORMAL PLAYBACK: start normal playback.
- PLAYBACK AGAIN: start the digest playback again.
- SAVE TO PLAYLIST: save the digest playback images to the playlist. “PLAYBACK PLAYLIST” (p. 74)
- SELECT DATE: return to step 5.

Types of Digest Playback

Select the types of Digest Playback from the following. When "AUTO" is selected, playback is performed by shortening the video to the pre-set length of time.

Item	Details
AUTO	Playback is performed by shortening the video to the pre-set length of time. Depending on the recording time of the video, playback time can be selected from: 1 minute, 3 minutes, 5 minutes, 10 minutes, 15 minutes, 30 minutes, 45 minutes and 60 minutes. All the recorded parts (recording time is less than 1 minute) are played back.
SMILING FACE SCENE	Playback the scenes with detected smiles as a digest. It is necessary to set "SMILE SHOT" in "RECORD SETTING" to "ON" and record in advance. "Capturing Smiles Automatically (SMILE SHOT)" (p. 47)
REGISTERED FACE SCN	Playback the scenes mainly with a person whose face is registered "Registering Human Face Personal Authentication Information" (p. 50)
MARKED SCENE	Start a digest playback by piecing the scenes that are marked during recording.

PLAYBACK PLAYLIST

Plays back the playlists that you have created.

- 1 Open the LCD monitor.

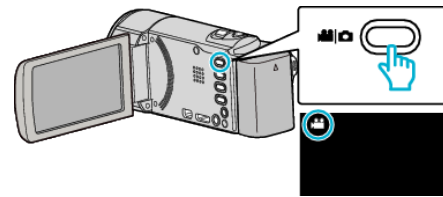

- Check if the recording mode is .
- If the mode is still image, tap on the recording screen to display the mode switching screen. Tap to switch the mode to video. (You can also use the button on this unit.)

- 2 Tap "<<PLAY" to select the playback mode.

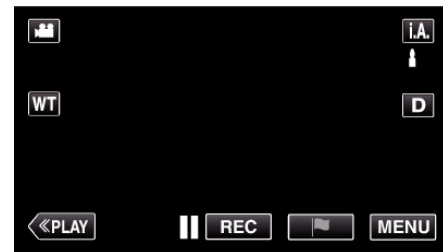

- 3 Tap "MENU".

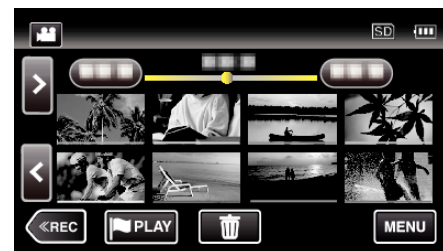

- 4 Tap "PLAYBACK SETTING".

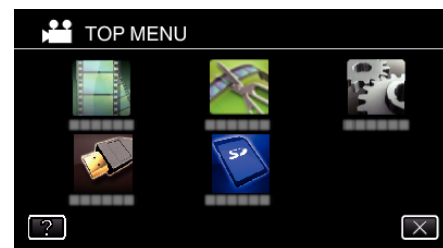

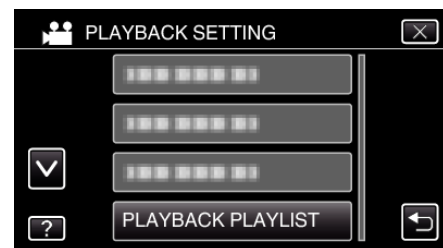

- 5 Tap "PLAYBACK PLAYLIST".

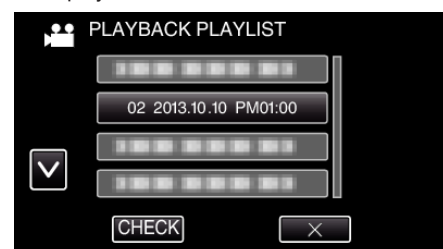

- 6 Tap to select a playlist.



- Playback of the playlist starts.
"Operation Buttons for Video Playback" (p. 67)

- Tap  to return to the index screen.
- Tap “CHECK” and select a playlist to check its content. After checking, tap .
- Playlists with a  (Digest Playback) icon are the playlists created during Digest Playback.





Creating Playlists: _____
 “Creating Playlists from the Recorded Videos” (p. 86)

PLAYBACK OTHER FILE

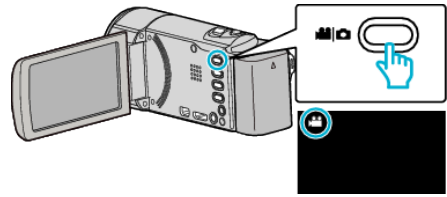
The management information of a video may be damaged if recording is not performed correctly, such as turning off the power in the middle of recording. You can perform the following operations to play back the videos with defective management information.

1 Open the LCD monitor.



- Check if the recording mode is .
- If the mode is  still image, tap  on the recording screen to display the mode switching screen. Tap  to switch the mode to video. (You can also use the  button on this unit.)

2 Tap “<<PLAY” to select the playback mode.



3 Tap “MENU”.



4 Tap “PLAYBACK SETTING”.

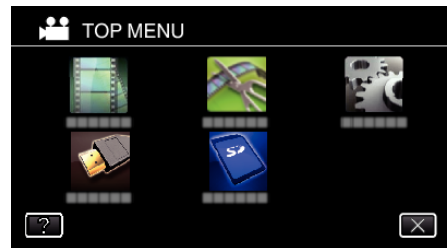

5 Tap “PLAYBACK OTHER FILE”.

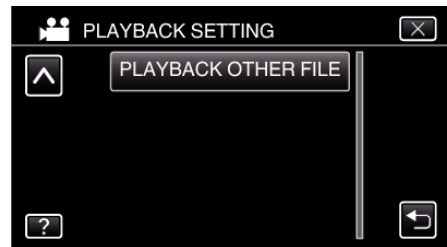

- 6 Tap on the file to start playback.



"Operation Buttons for Video Playback" (p. 67)

Memo :

- An MTS file is created in the EXTMOV folder when management information is corrupted.
- Depending on the condition of the damaged file, playback might fail or may not run smoothly.

Playing Back Still Images

You can select and play back the recorded still images from an index screen (thumbnail display).

- 1 Open the LCD monitor.

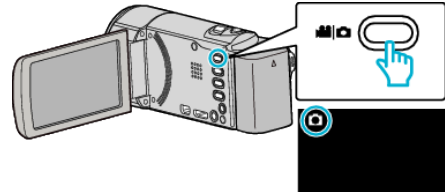

- Check if the recording mode is .
- If the mode is video, tap on the recording screen to display the mode switching screen. Tap to switch the mode to still image. (You can also use the button on this unit.)

- 2 Tap "<<PLAY" to select the playback mode.

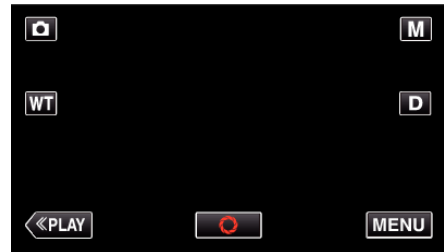

- 3 Tap on the file to start playback.



- Tap to return to the index screen.
- appears on the last image played back.
- Lines in different colors are displayed under the thumbnail display to distinguish the recording date.

Operation Buttons for Still Image Playback

During Index Screen Display

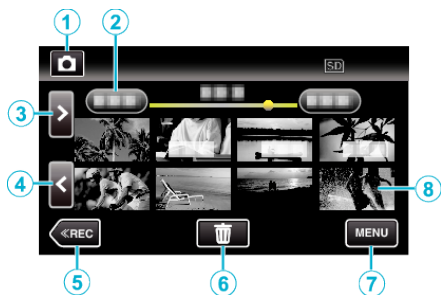

	Display	Description
①	Video/Still Image Mode 📺/📷	Switches between video and still image modes.
②	Date	Moves to the previous/next date
③	>	Displays the next index screen (thumbnail display) • You can perform the same operation with the zoom lever.
④	<	Displays the previous index screen (thumbnail display) • You can perform the same operation with the zoom lever.
⑤	<<REC	Switches to the recording mode.
⑥	🗑️	Displays the index screen (thumbnail display) to perform deletion
⑦	MENU	Displays the menu screen
⑧	File (Still Image)	Tap on thumbnail - Starts playback Drag to right - Scrolls to the right to show the previous index screen (thumbnail display) Drag to left - Scrolls to the left to show the next index screen (thumbnail display)

During Still Image Playback

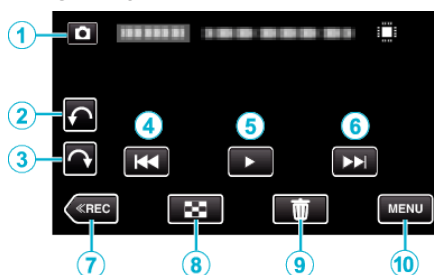

- Operations buttons on the touch screen disappear if the unit is not operated for about 5 seconds. Tap on the screen to display the operation buttons again.

	Display	Description
①	Video/Still Image Mode 📺/📷	Switches between video and still image modes.
②	↶	Rotates to the left (rotates by -90° with each tap)
③	↷	Rotates to the right (rotates by 90° with each tap)
④	⏮	Returns to the previous still image • You can perform the same operation with the zoom lever.
⑤	▶/⏸	Starts/pauses slideshow "Slideshow Playback" (📖 p. 78)
⑥	⏭	Advances to the next still image • You can perform the same operation with the zoom lever.
⑦	<<REC	Switches to the recording mode.
⑧	📺	Returns to index screen
⑨	🗑️	Deletes the currently displayed still image.
⑩	MENU	Displays the menu screen
-	◀	Starts reverse playback. • Displayed during slideshow playback.

Memo :

- Tap or drag on the operation area of the touch screen.
- You can rotate a still image 90° to the right or left during playback. Rotation applies to the on-screen display only.
- You can search for a specific file by the recording date. This is useful when searching from a large number of files. "Searching for a Specific Video/Still Image by Date" (📖 p. 78)

Caution :

- This unit is a microcomputer-controlled device. Electrostatic discharge, external noise and interference (from a TV, a radio, etc.) might prevent it from functioning properly. In such a case, turn off the power, then remove the AC adapter and battery pack. This unit will be reset.

Slideshow Playback

Still images can be played back in a slideshow.
Tap **▶** during still image playback to start the slideshow.

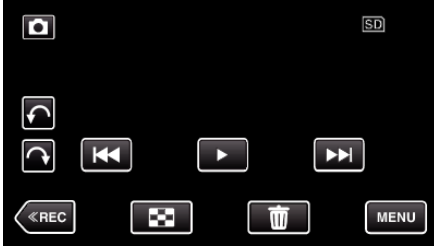

“Operation Buttons for Still Image Playback” (p. 77)

Memo :

- Effects can be added to the transitions in slideshow playback.
“SLIDE SHOW EFFECTS ” (p. 216)

Searching for a Specific Video/Still Image by Date

When there is a large number of recorded videos and still images, it is difficult to look for the desired file from the index screen. Use the search function to find the file you want. You can search and play videos or still images according to recording dates.

- 1 Tap “MENU”.



- Searching can be performed in both the video and still image modes.
*The image shows the video mode.

- 2 Tap “PLAYBACK SETTING”.

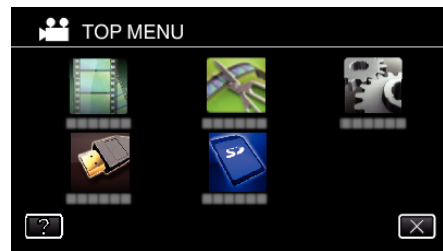

- 3 Tap “SEARCH DATE”.

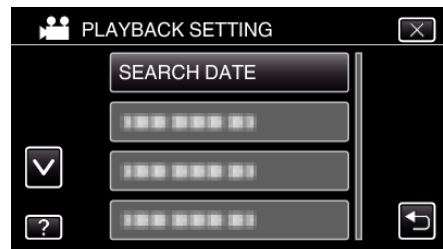

- 4 Tap a recording date, then tap “NEXT”.

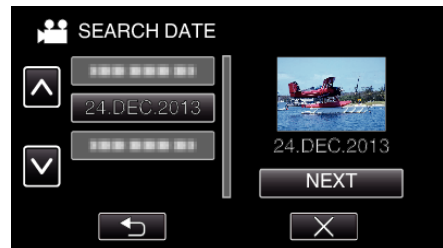

- Tap again to cancel the selected date.

- 5 Tap on the file to start playback.

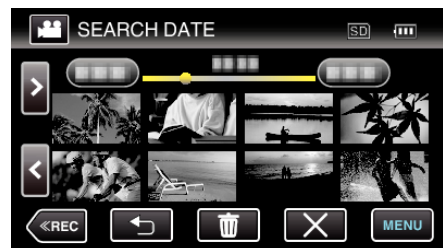

- You can select videos in the video mode and still images in the still image mode.
- Only the files recorded on the selected date are displayed.
- Tap X to stop searching and return to the index screen (thumbnail display).

Deleting Files of a Selected Date : _____
Tap **🗑** on the index screen (thumbnail display) to delete unwanted files.

Connecting to and Viewing on TV

You can connect this unit to a TV for playback. The image quality on TV varies with the type of TV and the connecting cable. Select the connector that best suits your TV.

- Refer also to the instruction manual of the TV in use.

"Connecting via the HDMI Mini Connector" (☞ p. 80)

"Connecting via the AV Connector" (☞ p. 81)

- To display the date and time on TV, set both "DISPLAY DATE/TIME" and "DISPLAY ON TV" to "ON".

"DISPLAY DATE/TIME" (☞ p. 214)

"DISPLAY ON TV" (☞ p. 221)

Unnatural Displays on TV

Trouble	Action
Images do not appear on the TV properly.	<ul style="list-style-type: none"> • Disconnect the cable and connect again. • Turn off and on this unit again. • Images may not appear properly when the remaining battery power is low. Use an AC adapter.
Images are projected vertically on the TV.	<ul style="list-style-type: none"> • Set "VIDEO OUTPUT" in the "CONNECTION SETTINGS" menu to "4:3". <p>"VIDEO OUTPUT" (☞ p. 221)</p>
Images are projected horizontally on the TV.	<ul style="list-style-type: none"> • Adjust the TV's screen accordingly.
The color of images looks strange.	<ul style="list-style-type: none"> • Adjust the TV's screen accordingly.
HDMI-CEC functions do not work properly, and the TV does not work in conjunction with this unit.	<ul style="list-style-type: none"> • TVs may operate differently depending on the specifications, even if they are HDMI-CEC compliant. Therefore, the HDMI-CEC functions of this unit cannot be guaranteed to operate in combination with all the TVs. In such cases, set "HDMI CONTROL" to "OFF". <p>"HDMI CONTROL" (☞ p. 221)</p>
The language on the display changed.	<ul style="list-style-type: none"> • It may occur when you connect this unit to a TV with different language setting using an HDMI mini cable.

Caution :

- Do not remove the recording medium or perform any other operation (such as turning off the power) while accessing files. Also, be sure to use the provided AC adapter, as the data on the recording medium may be corrupted if the battery becomes exhausted during operation. If the data on the recording medium becomes corrupted, format the recording medium to use the medium again.

Connecting via the HDMI Mini Connector

If you are using an HDTV, you can play back in HD quality by connecting to the HDMI mini connector.

- Use a High Speed HDMI mini cable as the HDMI mini cable when not using the provided one. (GZ-E307)
- Use a High Speed HDMI mini cable as the HDMI mini cable. (GZ-EX315/GZ-E305)
- Refer also to the instruction manual of the TV in use.

1 Connect to a TV.

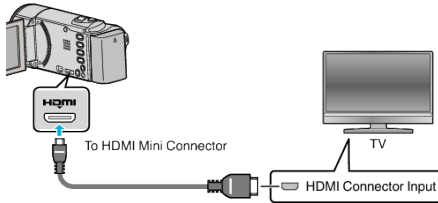

- Turn off the camcorder by pressing the  button for about 2 seconds.

2 Connect the AC adapter to this unit.

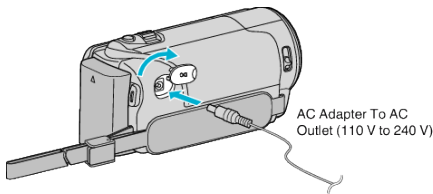

- The unit turns on automatically.

3 Press the external input button on the TV to switch to the input from this unit via the connected connector.



4 Play back a file.



“Playing Back Videos” (p. 65)

“Playing Back Still Images” (p. 76)

Memo :

- Change the settings in “HDMI OUTPUT” according to the connection. “HDMI OUTPUT” (p. 221)
- When connected to the TV via the HDMI mini cable, images and sounds may not be output properly depending on the TV connected. In such cases, perform the following operations.
 - 1) Disconnect the HDMI mini cable and connect it again.
 - 2) Turn off and on this unit again.
- For questions about the TV or method of connection, contact your TV's manufacturer.

Operating in Conjunction with TV via HDMI

Connecting this unit to an HDMI-CEC enabled TV using the HDMI mini cable allows linked operations with the TV to be performed.

- HDMI-CEC (Consumer Electronics Control) is an industry standard that enables interoperability between HDMI-CEC compliant devices that are connected via HDMI cables.

Memo :

- Not all HDMI control devices comply with the HDMI-CEC standard. The HDMI control function of this unit will not work when connected to these devices.
- This unit is not guaranteed to operate with all HDMI-CEC enabled devices.
- Depending on the specifications of each HDMI-CEC enabled device, some functions may not work with this unit. (For details, refer to the instruction manual of your TV.)
- Unintended operations may occur with some connected devices. In these cases, set "HDMI CONTROL" to "OFF".

"HDMI CONTROL" (p. 221)

Preparations

- Connect an HDMI mini cable between this unit and the TV.
- "Connecting via the HDMI Mini Connector" (p. 80)
- Turn on the TV and set the HDMI-CEC related setting to "ON". (For details, refer to the instruction manual of the TV.)
 - Set "HDMI CONTROL" in the CONNECTION SETTINGS menu to "ON".
- "HDMI CONTROL" (p. 221)

Operation Method 1

- 1 Turn on this unit.
- 2 Select the playback mode.
- 3 Connect the HDMI mini cable.
 - TV turns on automatically and switches to HDMI input mode when this unit is turned on.

Operation Method 2

- 1 Turn off the TV.
 - This unit turns off automatically.

Memo :

- Depending on the TV connected, the display language of this unit will automatically switch to the language that is selected for the TV when this unit is turned on. (This is applicable only if this unit supports the language selected for the TV.) To use this unit with a language that differs from the display language of the TV, set "HDMI CONTROL" to "OFF".
- The display language of the TV will not switch automatically, even if the display language of this unit is changed.
- These functions may not work correctly when devices such as amplifier and selector are connected. Set "HDMI CONTROL" to "OFF".
- If HDMI-CEC does not work properly, turn off and on this unit again.

Connecting via the AV Connector

To playback videos on TV, connect the provided AV cable (P/N QAM1322-001) to the AV terminal of this unit.

- Refer also to the instruction manual of the TV in use.

- 1 Connect to a TV.

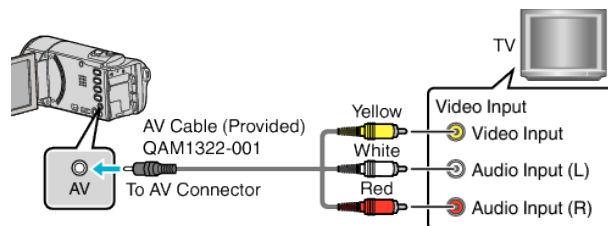

- Turn off the camcorder by pressing the button for about 2 seconds.

- 2 Connect the AC adapter to this unit.

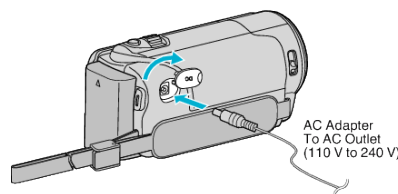

- The unit turns on automatically.

- 3 Press the external input button on the TV to switch to the input from this unit via the connected connector.



- 4 Play back a file.

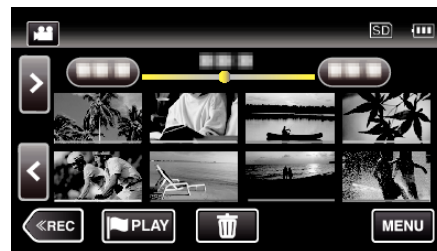

"Playing Back Videos" (p. 65)

"Playing Back Still Images" (p. 76)

Memo :

- For questions about the TV or method of connection, contact your TV's manufacturer.
- AV cable (P/N: QAM1322-001)

Wiring specifications (for video/audio) of the 4-pole mini plug are described in the following.

For purchasing, consult your nearest JVC service center.

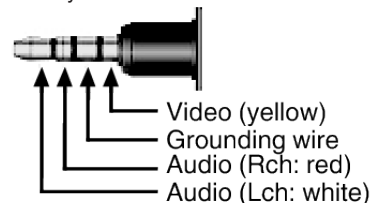

Deleting Unwanted Files

Delete unwanted videos and still images when the space in the recording media is running out.

Doing so frees up more space in the recording media.

“Deleting the Currently Displayed File” (p. 82)

“Deleting Selected Files” (p. 82)

Memo :

- Deleted files cannot be restored.
- When files in a playlist are deleted, the playlist changes.
- Files that are protected cannot be deleted.
Release protection before deleting the file.

“Protecting Files” (p. 83)

- Be sure to back up important files on a computer.

“Backing Up Files” (p. 96)

Deleting the Currently Displayed File

Deletes the currently displayed file.

Caution :

- Deleted files cannot be restored.

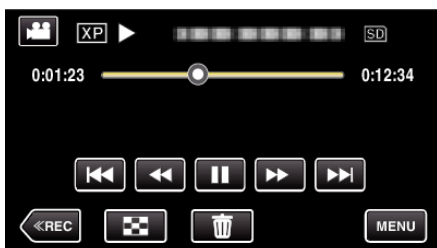

1 Tap .

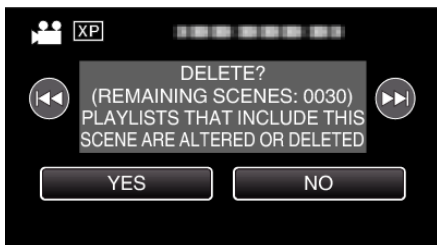

- While the video mode is shown in the image, the same operations apply for the still image mode.

2 Tap “YES”.



- Tap  or  to select the previous or next file.
- When no file remains, the screen returns to the index screen.

Deleting Selected Files







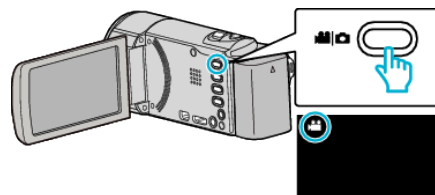

Deletes the selected files.

Caution :

- Deleted files cannot be restored.

1 Open the LCD monitor.



- Tap  or  to select the video or still image mode.
- Tap  or  on the recording screen to display the mode switching screen.
Tap  to switch to the video mode .
- Tap  to switch to the still image mode .
- (You can also use the  button on this unit.)

2 Tap “<<PLAY” to select the playback mode.

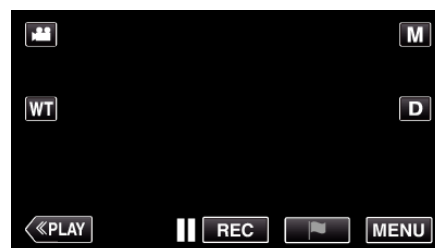

- While the video mode is shown in the image, the same operations apply for the still image mode.

3 Tap .

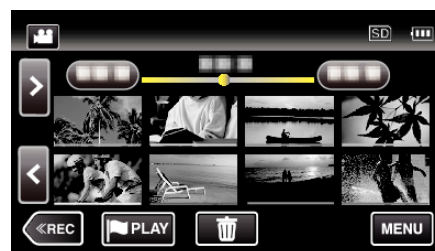

4 Tap on the files to delete.

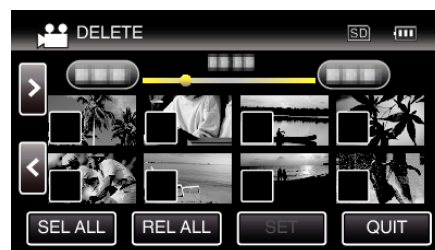

- ✓ appears on the selected files.
To remove ✓ from a file, tap on the file again.
- Tap “SEL ALL” to select all files.
- Tap “REL ALL” to release all selections.

5 Tap "SET".

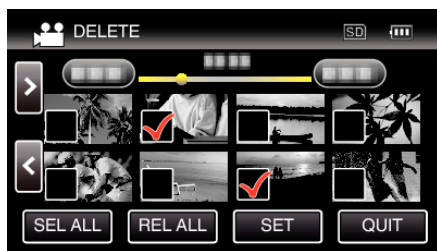

6 Tap "EXECUTE" to confirm the deletion.

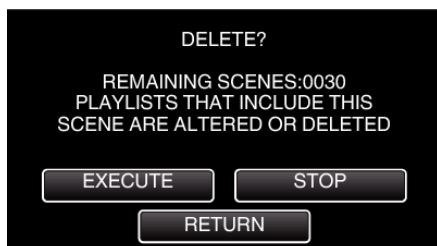

- After deleting is complete, tap "OK".
- To cancel the deletion, tap "QUIT".

Protecting Files

Prevent important videos/still images from being deleted accidentally by protecting them.

"Protecting/Releasing Protection of the Currently Displayed File"

(☞ p. 83)

"Protecting/Releasing Protection of Selected Files" (☞ p. 84)

Caution :

- When the recording media is formatted, even the protected files will be deleted.

Protecting/Releasing Protection of the Currently Displayed File

Protects or releases protection of the currently displayed file.

1 Tap "MENU".

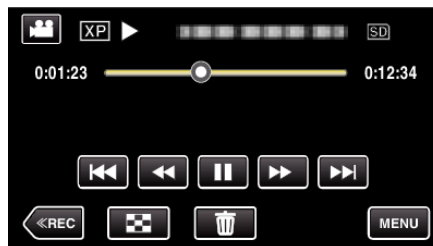

2 Tap "EDIT".

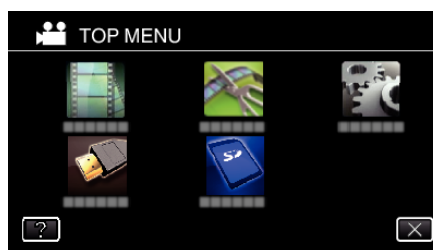

3 Tap "PROTECT/CANCEL".

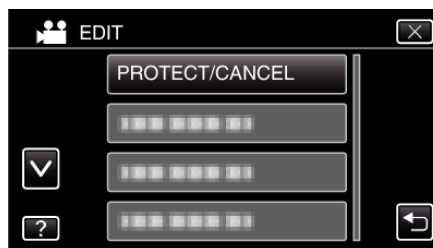

4 Tap "YES".



- Tap ◀◀ / ▶▶ to select the previous or next file.
- After setting, tap "OK".

Protecting/Releasing Protection of Selected Files

Protects or releases protection of the selected files.

1 Open the LCD monitor.

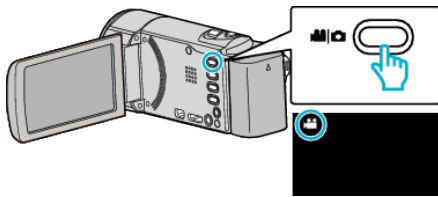

- Tap or to select the video or still image mode.
 - Tap or on the recording screen to display the mode switching screen.
Tap to switch to the video mode .
 - Tap to switch to the still image mode .
- (You can also use the / button on this unit.)

2 Tap "<<PLAY" to select the playback mode.

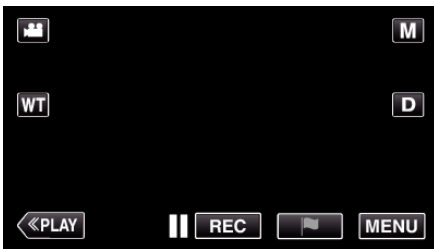

3 Tap "MENU".



4 Tap "EDIT".

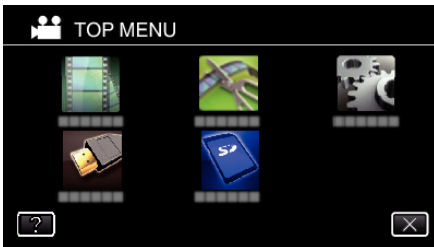

5 Tap "PROTECT/CANCEL".



6 Tap on the files to protect or release protection of.



- ✓ appears on the selected files.
To remove ✓ from a file, tap on the file again.
- and ✓ are displayed on the files that are already protected.
To release protection of a file, tap on the file such that ✓ is removed.
- Tap "SEL ALL" to select all files.
- Tap "REL ALL" to release all selections.

7 Tap "SET" to complete the setting.

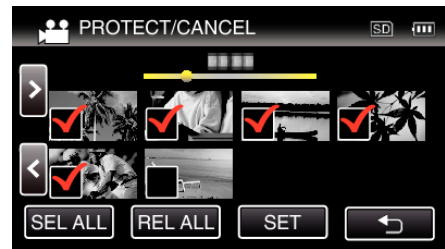

- Protect marks appear on the selected files.
Protect marks disappear from the deselected files.

Capturing a Still Image in the Video During Playback

You can capture still images of the scenes you like in the recorded videos.

- 1 Open the LCD monitor.

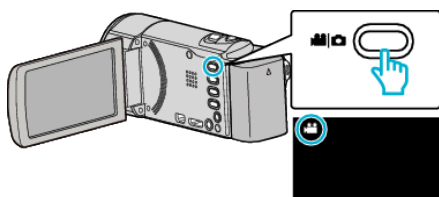

- Check if the recording mode is .
- If the mode is still image, tap on the recording screen to display the mode switching screen.
Tap to switch the mode to video. (You can also use the / button on this unit.)

- 2 Tap “<<PLAY” to select the playback mode.

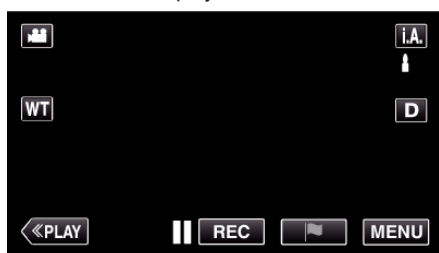

- 3 Tap on the desired video.

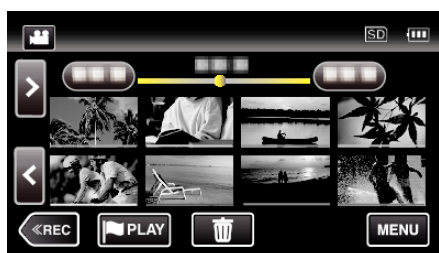

- 4 Tap pause at the desired scene during playback.

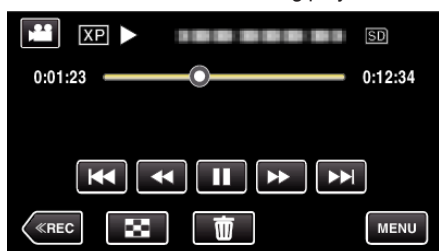

- After pausing the video, you can fine-tune the point to capture by tapping forward slow-motion and reverse slow-motion .

- 5 Press the SNAPSHOT button.

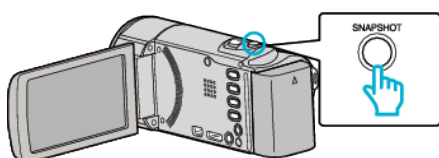

Memo :

- Still images are captured with a size of 1920×1080.
- Captured still images are stored in the media where the video is being played back from.

Capturing a Required Part in the Video (TRIMMING)

Select the required part of a video and save it as a new video file.

- The original video remains in its existing location.

- 1 Open the LCD monitor.

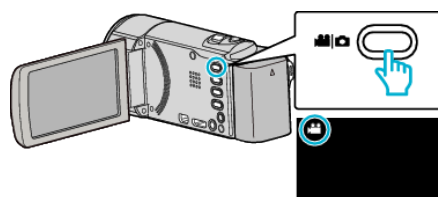

- Check if the recording mode is .
- If the mode is still image, tap on the recording screen to display the mode switching screen.
Tap to switch the mode to video. (You can also use the / button on this unit.)

- 2 Tap “<<PLAY” to select the playback mode.

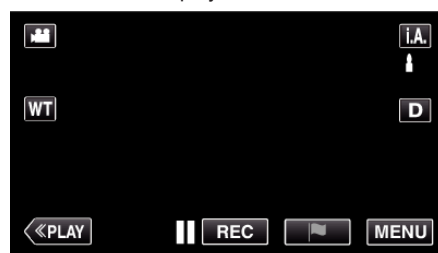

- 3 Tap “MENU”.

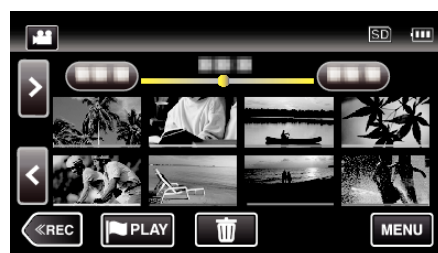

- 4 Tap “EDIT”.

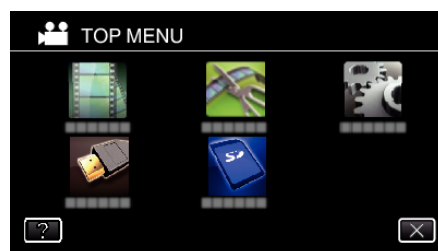

- 5 Tap “TRIMMING”.

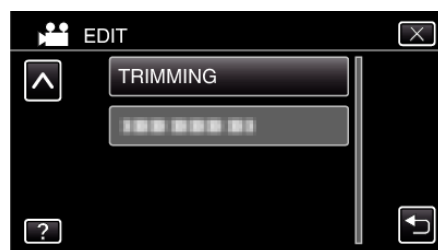

6 Tap the video to edit.

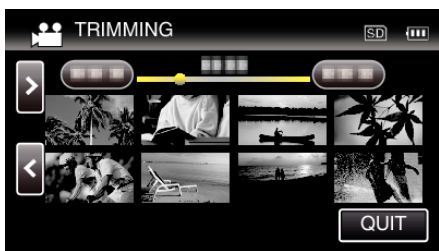

7 Tap **||** to pause playback at the desired start point, then tap "A".

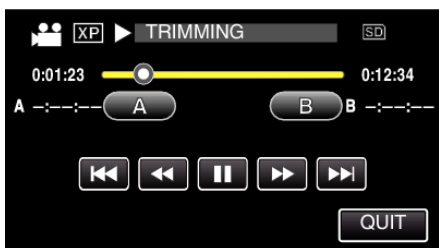

- When "A" is tapped, the start point is set.
- After setting the start point, tap **▶** to continue playback.

8 Tap **||** to pause playback at the desired end point, then tap "B".

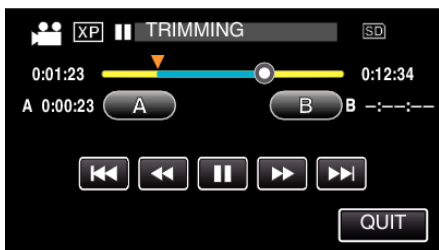

- When "B" is tapped, the end point is set.
- To reset the start or end point, tap "A" or "B" at the desired scene (position).

9 Tap "SET".

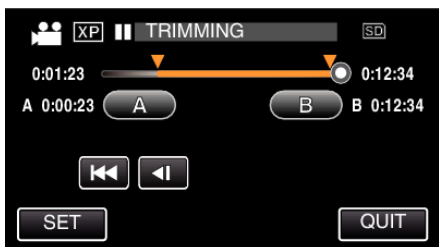

- When "SET" is tapped, the trimming area is confirmed.

10 Tap "YES".



- After copying, tap "OK".
- When copying finishes, the copied file is added to the index screen.

Memo : _____

- The division point may deviate slightly from the selected scene.

Creating Playlists from the Recorded Videos

A list created by selecting your favorite videos from the recorded ones is called a playlist.

By creating a playlist, you can play back only your favorite videos in the order you like.

The original video file remains even when it is registered to a playlist.

- To create a new playlist
 "Creating Playlists with Selected Files" (p. 86)
 "Creating Playlists by Date" (p. 88)
- To edit or delete a created playlist
 "Editing Playlists" (p. 89)
 "Deleting Playlists" (p. 90)

Memo : _____

- When a video file is deleted or moved, the same file will be removed from the playlist.
- Videos recorded in the iFrame format can not be selected when creating a playlist. (GZ-EX315)

Creating Playlists with Selected Files

Create a playlist by arranging the files one by one.

1 Open the LCD monitor.

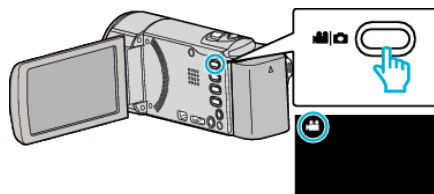

- Check if the recording mode is **📹**.
- If the mode is **📷** still image, tap **📷** on the recording screen to display the mode switching screen.
 Tap **📹** to switch the mode to video. (You can also use the **📷/📹** button on this unit.)

2 Tap "<<PLAY" to select the playback mode.

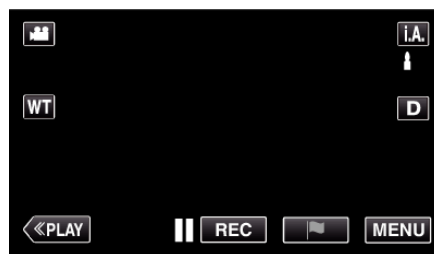

3 Tap "MENU".

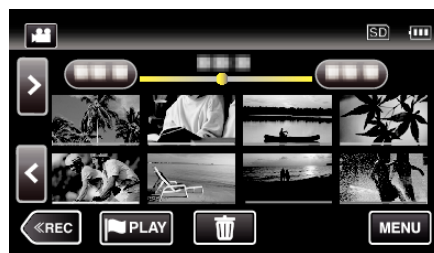

4 Tap "EDIT".

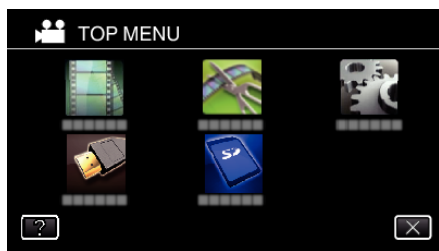

5 Tap "EDIT PLAYLIST".

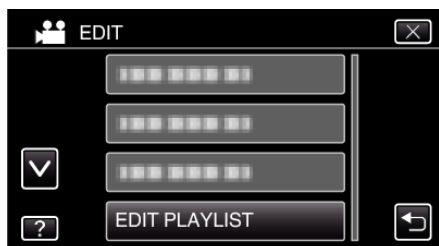

6 Tap "NEW LIST".

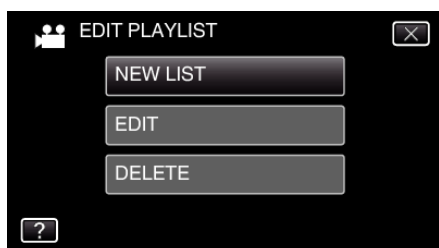

7 Tap "CREATE FROM SCENE".

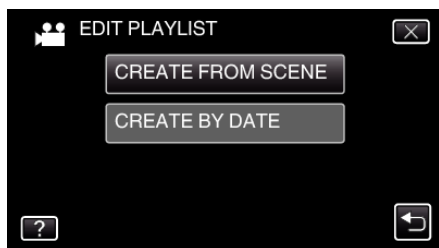

8 Tap on the video to add to playlist.

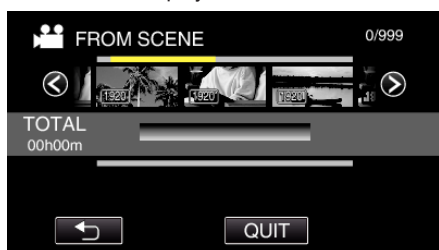

- ▶ appears on the selected video. Tap ↵ to deselect.
- Tap on the selected video again to check the video. After checking, tap ↵.
- Tap </> or move the zoom lever to display the previous/next video.
- [1920] indicates the size of the video.

9 Tap "ADD", and insert the video image.



- Repeat steps 8-9 and arrange the videos in the playlist.
- To change the position of a video in the playlist (lower row), select the insertion point with ←/→ after step 8 and tap "ADD".
- ▶ appears when the inserted video is selected. Tap ↵ to deselect.
- Tap on the selected video again to check the video. After checking, tap ↵.
- To delete of a video in the playlist (lower row), tap the video, then tap "CANCEL".
- [1920] indicates the size of the video.

10 After arranging, tap "SAVE".

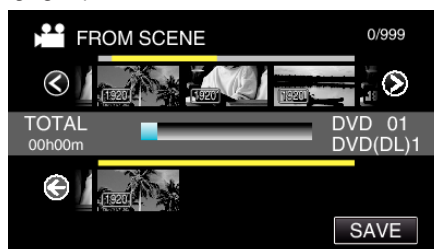

11 Tap "YES".

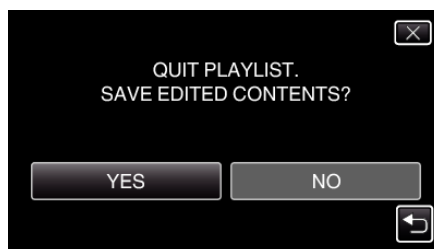

Memo :

- Tap X on each screen to exit the menu.

Creating Playlists by Date

Create a playlist by arranging multiple files according to recording date.

1 Open the LCD monitor.

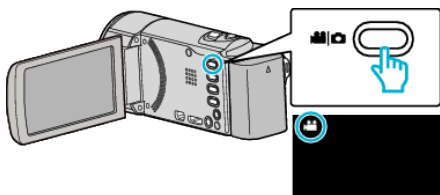

- Check if the recording mode is .
- If the mode is still image, tap on the recording screen to display the mode switching screen. Tap to switch the mode to video. (You can also use the button on this unit.)

2 Tap “<<PLAY” to select the playback mode.



3 Tap “MENU”.

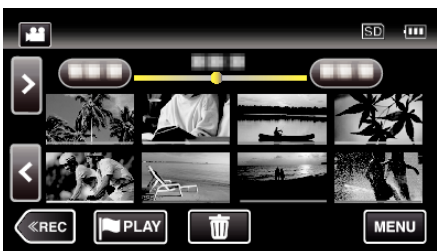

4 Tap “EDIT”.

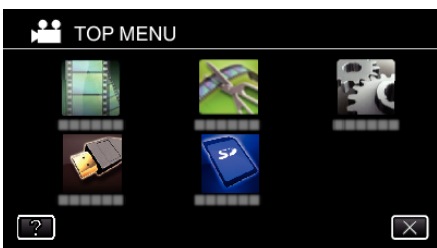

5 Tap “EDIT PLAYLIST”.

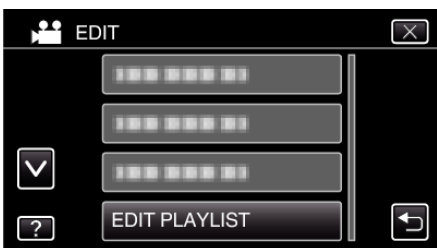

6 Tap “NEW LIST”.

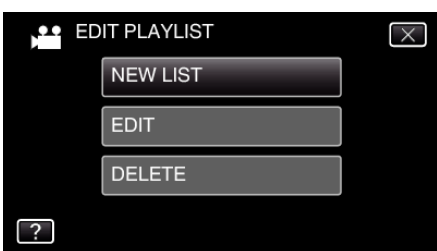

7 Tap “CREATE BY DATE”.

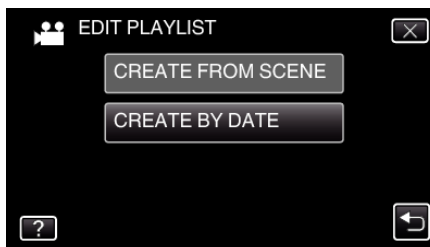

8 Tap on the video of the date to add to playlist.

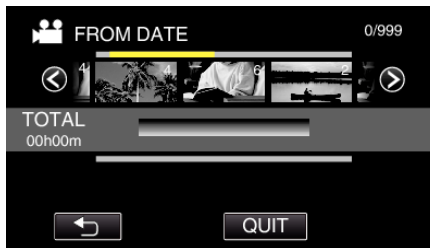

- appears on the selected video. Tap to deselect.
- Tap on the selected video again to check all the videos of the same date. After checking, tap .
- Tap or move the zoom lever to display the previous/next video.
- The number on the video indicates the number of videos recorded on the same day.

9 Tap “ADD”, and insert the video image.

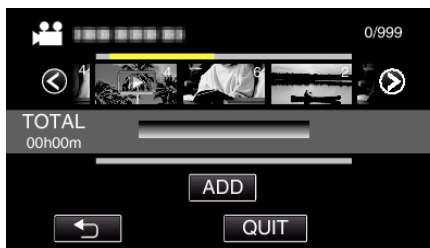

- Repeat steps 8-9 and arrange the videos in the playlist.
- To change the position of a video in the playlist (lower row), select the insertion point with / after step 8 and tap “ADD”.
- appears when the inserted video is selected. Tap to deselect.
- Tap on the selected video again to check all the videos of the same date. After checking, tap .
- To delete of a video in the playlist (lower row), tap the video, then tap “CANCEL”.

10 After arranging, tap “SAVE”.

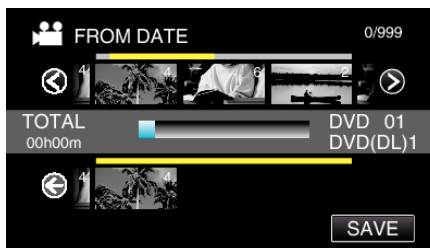

11 Tap “YES”.

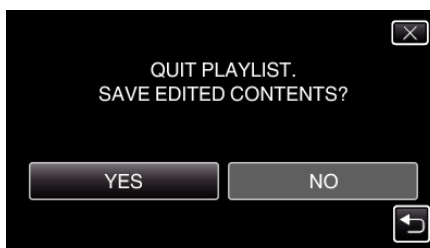

Memo :

- Tap X on each screen to exit the menu.

Editing Playlists

You can change the content of a created playlist. However, the playlists created from Digest Playback cannot be changed.

1 Open the LCD monitor.

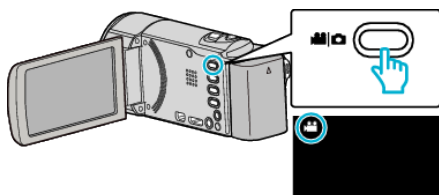

- Check if the recording mode is .
- If the mode is still image, tap on the recording screen to display the mode switching screen. Tap to switch the mode to video. (You can also use the button on this unit.)

2 Tap "<<PLAY" to select the playback mode.

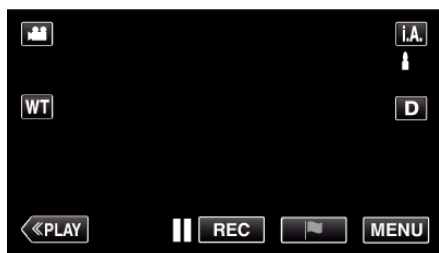

3 Tap "MENU".

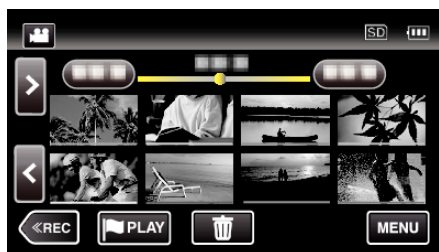

4 Tap "EDIT".

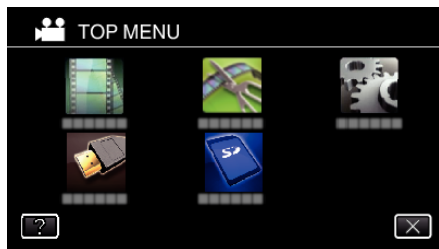

5 Tap "EDIT PLAYLIST".

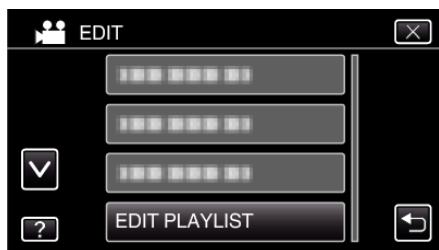

6 Tap "EDIT".

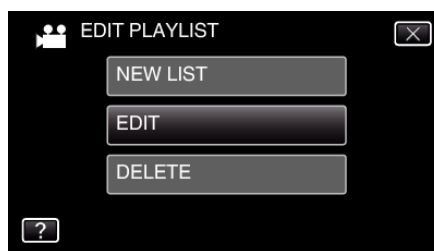

7 Tap on the playlist to edit, and tap "NEXT".

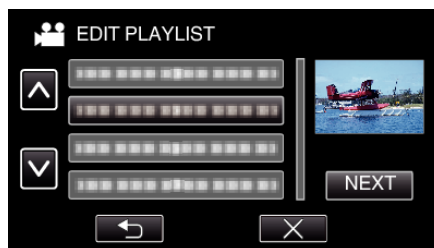

8 Tap on the video (upper row) to arrange in the playlist.

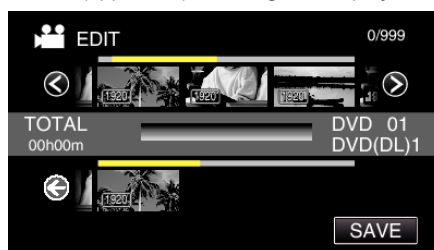

- appears on the selected video. Tap to deselect.
- Tap on the selected video again to check the video. After checking, tap .
- Tap or move the zoom lever to display the previous/next video.
- indicates the size of the video.

9 Tap "ADD", and insert the video image.

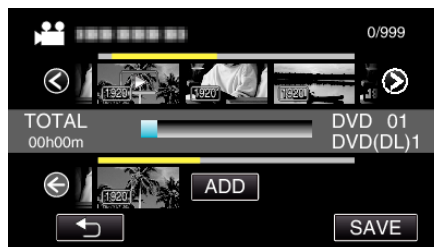

- Repeat steps 8-9 and arrange the videos in the playlist.
- To change the position of a video in the playlist (lower row), select the insertion point with after step 8 and tap "ADD".
- appears when the inserted video is selected. Tap to deselect.
- Tap on the selected video again to check the video. After checking, tap .
- To delete of a video in the playlist (lower row), tap the video, then tap "CANCEL".
- indicates the size of the video.

10 After arranging, tap “SAVE”.

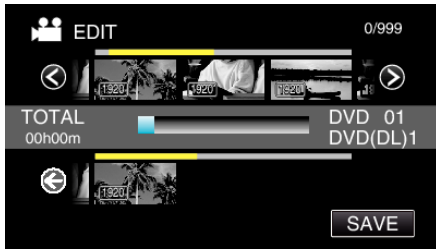

11 Tap “YES”.



Memo :

- Tap X on each screen to exit the menu.

Deleting Playlists

Delete the playlists that you have created.

1 Open the LCD monitor.

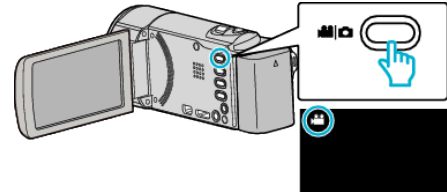

- Check if the recording mode is .
- If the mode is still image, tap on the recording screen to display the mode switching screen. Tap to switch the mode to video. (You can also use the button on this unit.)

2 Tap “<<PLAY” to select the playback mode.



3 Tap “MENU”.



4 Tap “EDIT”.

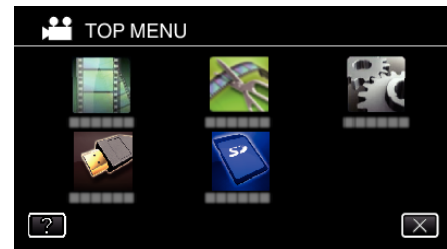

5 Tap “EDIT PLAYLIST”.

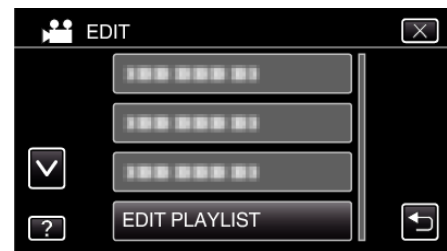

6 Tap "DELETE".

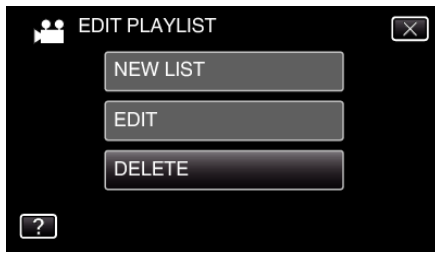

7 Tap on the playlist to delete, and tap "NEXT".

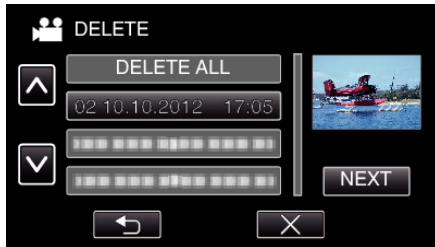

- All created playlists will be deleted when "DELETE ALL" is selected.

8 Tap "YES" to confirm the deletion.

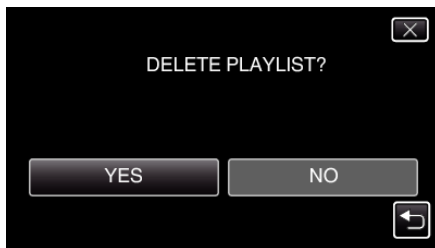

- After deleting, tap "OK".
- After deleting is complete, the screen returns to the delete playlist selection screen.

Memo :

- Tap X on each screen to exit the menu.

Creating a Disc Using a Connected Blu-ray Recorder

You can create discs using a Blu-ray recorder by connecting it to this unit using a USB cable.

- 1 Remove the AC adapter and battery pack from this unit.
- 2 Open the LCD monitor.

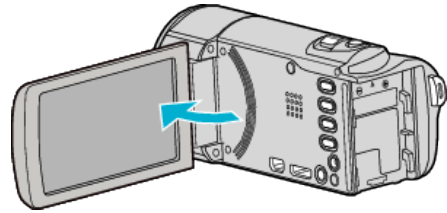

3 Connect to a Blu-ray recorder.

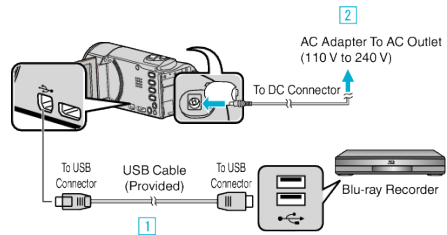

- 1 Connect using the provided USB cable.
- 2 Connect the AC adapter to this unit.
 - This unit powers on automatically when the AC adapter is connected, and the "SELECT DEVICE" screen is displayed.
 - Be sure to use the supplied AC adapter.

4 Tap "CONNECT TO OTHER".



- Operations are to be performed on the Blu-ray recorder after the screen switches.

5 Perform dubbing on the Blu-ray recorder.

- Refer also to the instruction manual of the Blu-ray recorder.
- After dubbing is complete, disconnect the USB cable. Operations cannot be performed on this unit until the USB cable is disconnected.

Dubbing Files to a Disc by Connecting to a DVD Recorder

You can dub videos in standard quality by connecting to a DVD recorder.

- Refer also to the instruction manuals of the TV and DVD recorder.

- 1 Remove the AC adapter and battery pack from this unit.
- 2 Open the LCD monitor.

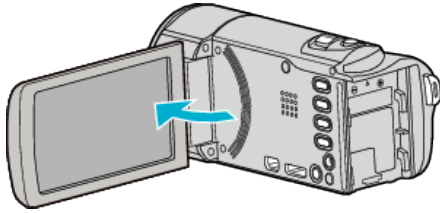

- 3 Connect to a DVD recorder.

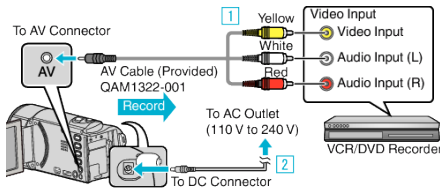

- 1 Connect using the provided AV cable.
- 2 Connect the AC adapter to this unit.
 - This unit powers on automatically when the AC adapter is connected.
 - Be sure to use the supplied AC adapter.

- 4 Tap "<<PLAY" to select the playback mode.



- 5 Prepare the TV/DVD recorder for recording.
 - Switch to a compatible external input.
 - Insert a disc (DVD-R, etc.) into the DVD recorder.
- 6 Prepare this unit for playback.
 - Set "VIDEO OUTPUT" in the "CONNECTION SETTINGS" menu to the aspect ratio ("4:3" or "16:9") of the connecting TV.
 - "VIDEO OUTPUT" (p. 221)
- 7 Start recording.
 - Start playback on this unit and press the record button on the recorder.
 - "Playing Back Videos" (p. 65)
 - After playback is complete, stop the recording.

Memo :

- AV cable (P/N: QAM1322-001)
- Wiring specifications (for video/audio) of the 4-pole mini plug are described in the following.
For purchasing, consult your nearest JVC service center.

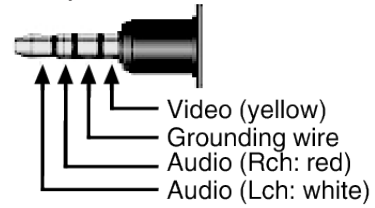

Memo :

- When there are many videos to dub, you can create a playlist in advance and play it back so that all your favorite videos can be dubbed at once.
- "Creating Playlists with Selected Files" (p. 86)
"PLAYBACK PLAYLIST" (p. 74)
- To include the recording date and time during dubbing, set "DISPLAY DATE/TIME" in the "PLAYBACK SETTING" menu to "ON". Or, set "DISPLAY ON TV" in the "CONNECTION SETTINGS" menu to "ON".

Dubbing Files to a VHS Tape by Connecting to a VCR

You can dub videos in standard quality by connecting to a VCR.

- Refer also to the instruction manuals of the TV and VCR.

- 1 Remove the AC adapter and battery pack from this unit.
- 2 Open the LCD monitor.

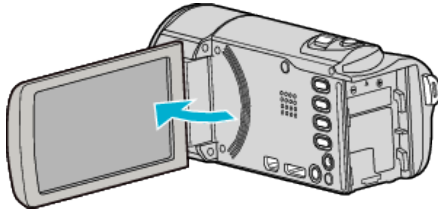

- 3 Connect to a VCR/DVD recorder.

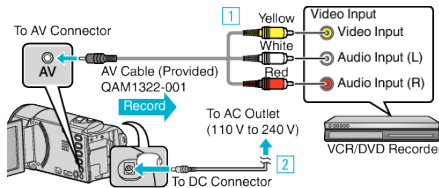

- 1 Connect using the provided AV cable.
- 2 Connect the AC adapter to this unit.
 - This unit powers on automatically when the AC adapter is connected.
 - Be sure to use the supplied AC adapter.

- 4 Tap "<<PLAY" to select the playback mode.



- 5 Prepare the TV/VCR for recording.
 - Switch to a compatible external input.
 - Insert a video tape.
- 6 Prepare this unit for playback.
 - Set "VIDEO OUTPUT" in the "CONNECTION SETTINGS" menu to the aspect ratio ("4:3" or "16:9") of the connecting TV.

"VIDEO OUTPUT" (p. 221)
- 7 Start recording.
 - Start playback on this unit and press the record button on the recorder.

"Playing Back Videos" (p. 65)

 - After playback is complete, stop the recording.

Memo : _____

- AV cable (P/N: QAM1322-001)
- Wiring specifications (for video/audio) of the 4-pole mini plug are described in the following.
For purchasing, consult your nearest JVC service center.

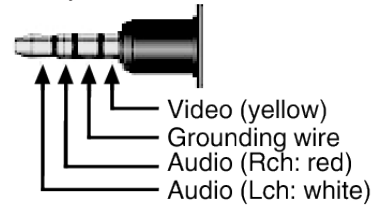

Memo : _____

- When there are many videos to dub, you can create a playlist in advance and play it back so that all your favorite videos can be dubbed at once.
- "Creating Playlists with Selected Files" (p. 86)
"PLAYBACK PLAYLIST" (p. 74)
- To include the recording date and time during dubbing, set "DISPLAY DATE/TIME" in the "PLAYBACK SETTING" menu to "ON". Or, set "DISPLAY ON TV" in the "CONNECTION SETTINGS" menu to "ON".

Copying to Windows PC (GZ-EX315)

You can copy files to a computer using the provided software.

Discs can also be created using the computer's DVD or Blu-ray drive.

If the provided software is not installed, this unit will be recognized as an external storage when connected.

Memo :

- To record to discs, a recordable DVD or Blu-ray drive is required for the computer in use.
- Still images cannot be recorded to discs using the provided software.
- Videos recorded in the iFrame format can not be copied.
- In order to record on the Blu-ray disc, it is necessary to upgrade to the paid version of LoLoFit for Everio.
For details, refer to the following link.

<http://loilo.tv/us/product/33/page/27>

- Backing up of files using other softwares is not supported.

Trouble with Using the Provided Software LoLoFit for Everio

Consult the customer service center below.

http://loilo.tv/gb/product/LoiLoFit_for_Everio

- For details on how to upload to YouTube, refer to "Help" in LoLoFit for Everio.

Verifying System Requirements (Guideline)

Right-click on "Computer" (or "My Computer") in the "Start" menu and select "Properties" to check the following items.

Windows Vista/Windows 7

- Refer to the operating instructions found in the animation on the Detailed User Guide.

Windows XP

- Refer to the operating instructions found in the animation on the Detailed User Guide.

	Windows Vista/Windows 7	Windows XP
OS	Windows Vista 32/64-bit Home Basic or Home Premium (Pre-installed versions only) Service Pack 2 Windows 7 32/64-bit Home Premium (Pre-installed versions only) Service Pack 1	Windows XP Home Edition or Professional (Pre-installed versions only) Service Pack 3
CPU	Intel Core 2 Duo, CPU 2 GHz or higher	
RAM	At least 2 GB	
Graphics	(during playback/backing up): Intel 965 or later, NVIDIA Geforce 6000 series or later, ATI Radeon 9600 or later (during video editing/creating a disc/converting video/uploading): Intel G45 or later, NVIDIA Geforce 8000 series or later (except for 8800GTX and 8300), ATI Radeon HD2000 series or later (except for 2900)	

■ Other requirements

- VRAM: 256MB or higher
- Microsoft .NET Framework 3.5 SP1 needs to be installed.
- To edit/playback videos, the use of a computer with Intel Core i7 (4 core) CPU is recommended.

Memo :

- If your PC does not meet the above system requirements, operations of the provided software cannot be guaranteed.
- Depending on the PC environment, even if the operating environment is adequate, 1 frame per second may be reduced during video playback.
- There is no guarantee that the operations will work with all computer environments.
- For more information, contact your PC's manufacturer.

Installing the Provided Software

You can display the recorded images in calendar format and perform editing using the provided software.

Windows Vista/Windows 7

- Refer to the operating instructions found in the animation on the Detailed User Guide.
-

Windows XP

- Refer to the operating instructions found in the animation on the Detailed User Guide.

Copying

Backing Up Files

Before making backup, make sure that enough free space is left in the computer's hard disk (HDD). Backup will not start if there is not enough free space.

- 1 Remove the AC adapter and battery pack from this unit.
- 2 Open the LCD monitor.

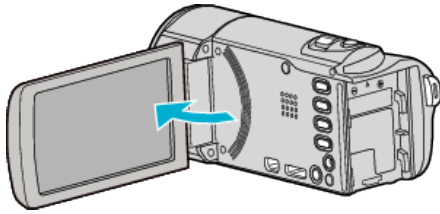

- 3 Connect the USB cable and the AC adapter.

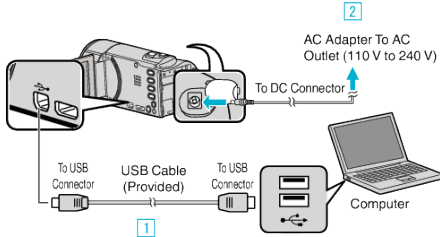

- 1 Connect using the provided USB cable.
 - 2 Connect the AC adapter to this unit.
- This unit powers on automatically when the AC adapter is connected.
 - Be sure to use the supplied AC adapter.
 - 3 The "SELECT DEVICE" menu appears.
- 4 Tap "CONNECT TO PC".



- 5 Tap "BACK UP".

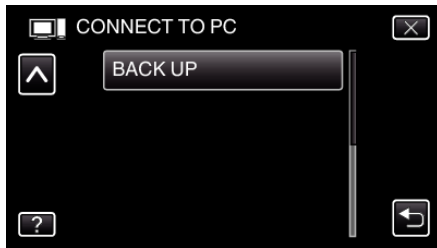

- Tap X to exit the menu.
 - Tap ↶ to return to the previous screen.
 - The provided software *LoiLoFit* for *Everio* starts up on the computer. The subsequent operations are to be performed on the computer.
- 6 Select the files to back up.

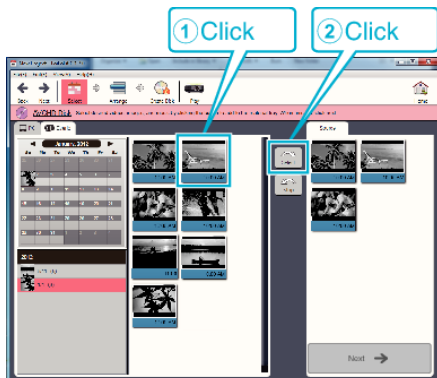

- Click "Select all" to select all the files at once.

- 7 After selecting, click "Next".

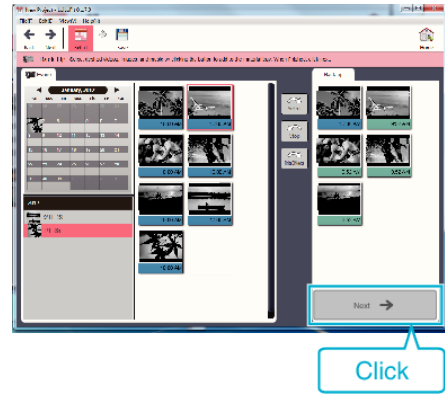

- 8 Click "Yes" to start backup.

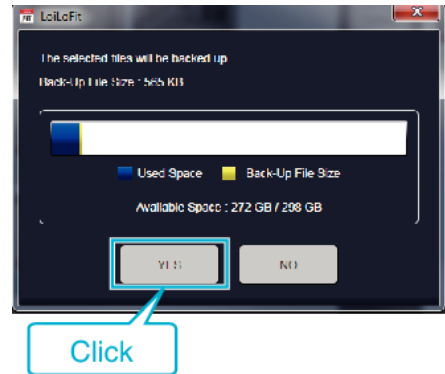

- Backup starts.
- The tab on the right side becomes blank when the backup is completed.

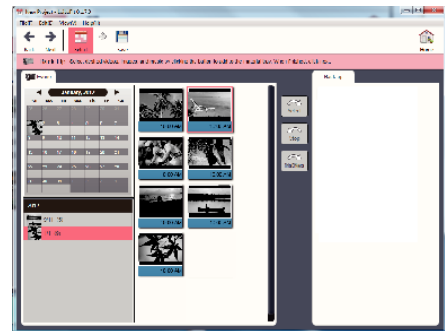

Memo :

- Videos recorded in the iFrame format can not be copied.
 - Before making backup, load the SD card in which the videos and still images are stored on this unit.
 - After backing up your files using the provided software, they cannot be restored to this unit.
 - Delete unwanted videos before making backup. It takes time to back up many videos.
- "Deleting Unwanted Files" (p. 82)

Disconnecting this Unit from Computer

- 1 Click "Safely Remove Hardware and Eject Media".

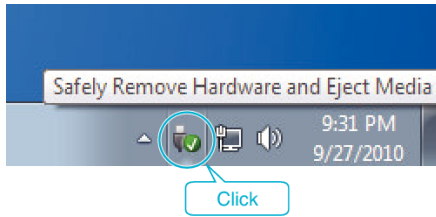

- 2 Click "Safely Remove USB Mass Storage Device".
- 3 (For Windows Vista) Click "OK".
- 4 Disconnect the USB cable and close the LCD monitor.

Recording Videos to Discs

- 1 Insert a new disc into the PC's recordable DVD or Blu-ray drive.
- 2 Click "Disk" to select the disc type.



- 3 Select the date that the desired videos for saving on the disc was recorded.

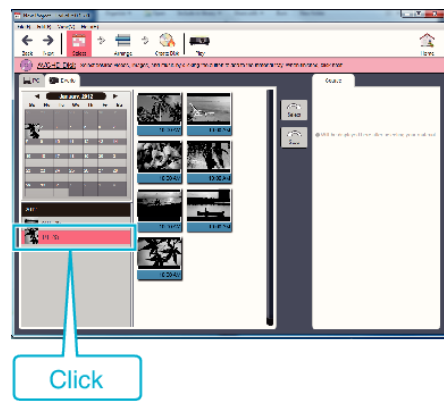

- 4 Select the files to save.

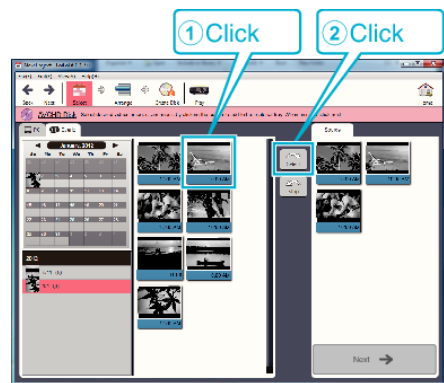

- 5 Click "Next".

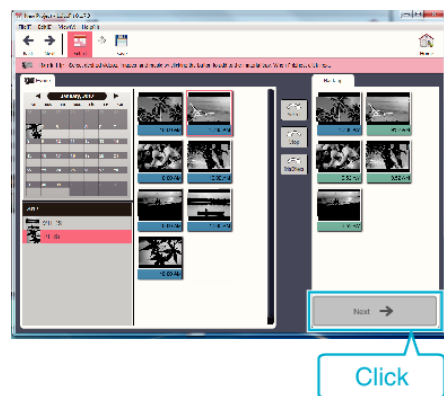

Copying

- 6 Sort the files in your desired order.



- 7 Click "Create Disk".



- 8 After copying, click "Cancel".

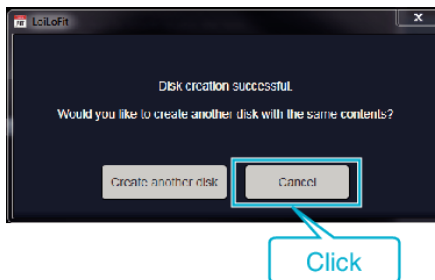

- Click "Cancel" to end creating the disc.

Memo :

- The following types of discs can be used on the provided software LoiLoFit for Everio.
 - DVD-R
 - DVD-R DL
 - DVD-RW
- In order to record on the Blu-ray disc, it is necessary to upgrade to the paid version of LoiLoFit for Everio.
For details, refer to the following link.
<http://loilo.tv/us/product/33/page/27>
- Videos recorded in the iFrame format can not be copied.
- Depending on the PC environment, even if the operating environment is adequate, 1 frame per second may be reduced during video playback.
- To view the help file of LoiLoFit for Everio, select "Help" from the LoiLoFit for Everio's menu bar or press F1 on the keyboard.
- If you are unable to activate while creating a disc, complete activation by following the instruction on the screen.

Backing Up Files Without Using Provided Software

Copy the files to a computer using the following method.

- 1 Remove the AC adapter and battery pack from this unit.
- 2 Open the LCD monitor.

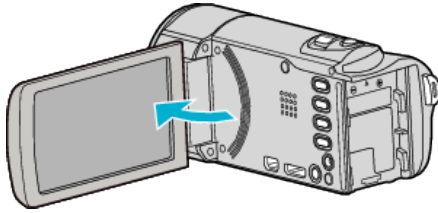

- 3 Connect the USB cable and the AC adapter.

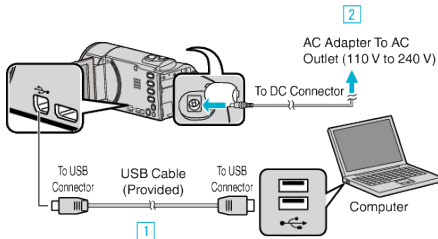

- 1 Connect using the provided USB cable.
 - 2 Connect the AC adapter to this unit.
- This unit powers on automatically when the AC adapter is connected.
 - Be sure to use the supplied AC adapter.
- 3 The "SELECT DEVICE" menu appears.
- 4 Tap "CONNECT TO PC".



- 5 Tap "PLAYBACK ON PC".



- Tap X to exit the menu.
- Tap ↶ to return to the previous screen.
- Close the LoiLoFit for Everio program, if it starts.
- The following screen is displayed after the camera operation is completed.

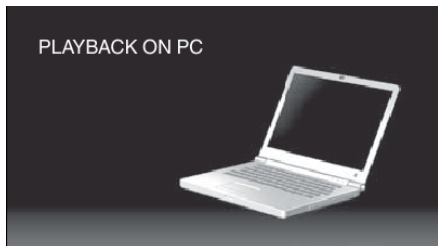

- Operations are to be performed on the computer after the screen switches.
- 6 Select "Computer" (Windows Vista)/"My Computer" (Windows XP)/"Computer" (Windows 7) from the "Start" menu, then click on the "JVCCAM_SD" icon.
 - Open the folder with the desired files.

"List of Files and Folders" (p. 100)

- 7 Copy the files to any folder in the computer (desktop, etc).

Memo : _____

- To edit/view the files, use a software that supports iFrame (video)/ AVCHD (video)/JPEG (still image) files.
- The above operations on computer may vary with the system used.

Disconnecting this Unit from Computer

- 1 Click "Safely Remove Hardware and Eject Media".

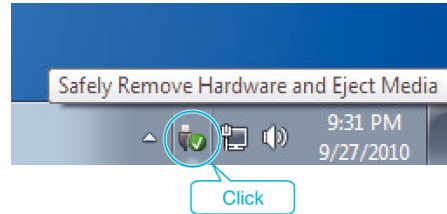

- 2 Click "Safely Remove USB Mass Storage Device".
- 3 (For Windows Vista) Click "OK".
- 4 Disconnect the USB cable and close the LCD monitor.

Copying

List of Files and Folders

Folders and files are created in the SD card as shown below.
They are created only when necessary.

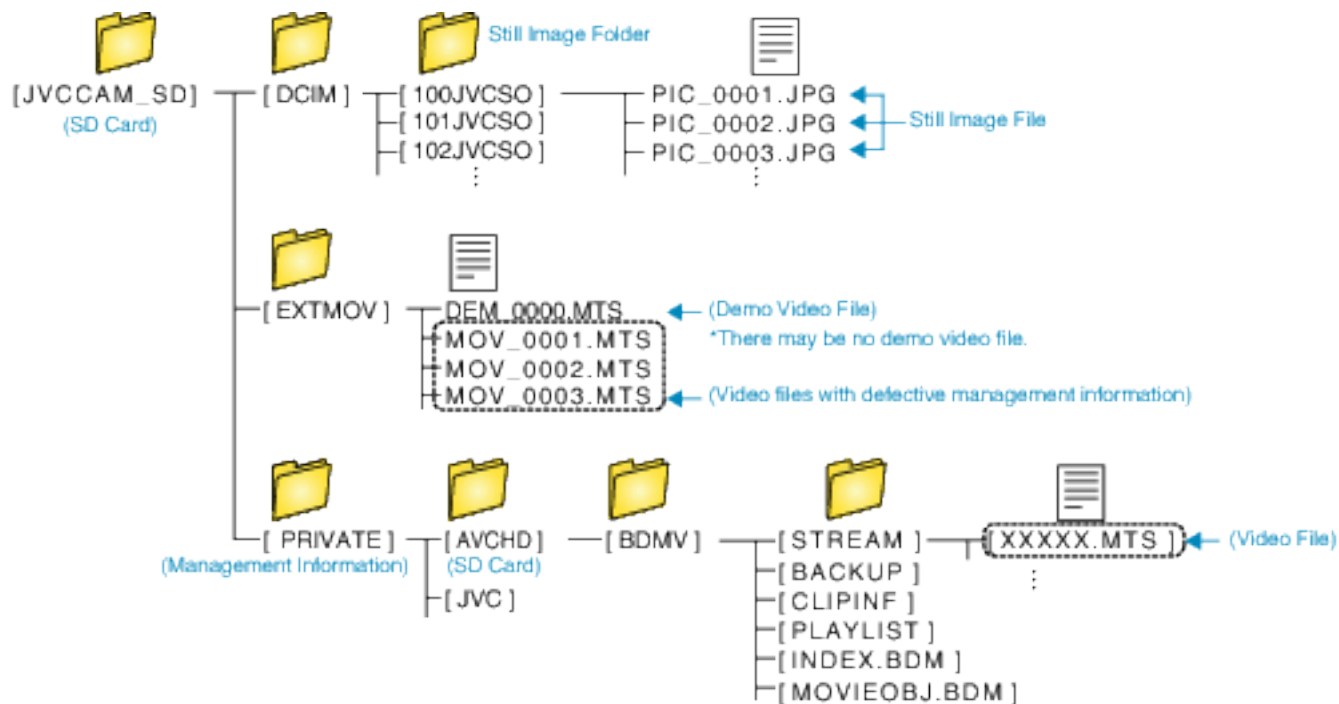

Caution :

- When the camera and PC are connected by an USB cable, recorded media are read-only.

Copying to Windows PC (GZ-E307/GZ-E305)

You can copy files to a computer using the provided software.

Discs can also be created using the computer's DVD or Blu-ray drive.

If the provided software is not installed, this unit will be recognized as an external storage when connected.

Memo :

- To record to discs, a recordable DVD or Blu-ray drive is required for the computer in use.
- Still images cannot be recorded to discs using the provided software.
- To create DVD-Video discs, it is necessary to install the additional software.
For details, refer to the Pixela homepage.

<http://www.pixela.co.jp/oem/jvc/mediabrowser/e/>

- Backing up of files using other softwares is not supported.

Trouble with Using the Provided Software Everio MediaBrowser 4

Consult the customer service center below.

- Pixela User Support Center

Telephone	USA and Canada (English): +1-800-458-4029 (toll-free) Europe (UK, Germany, France, and Spain) (English/German/French/Spanish): +800-1532-4865 (toll-free) Other Countries in Europe (English/German/French/Spanish): +44-1489-564-764 Asia (Philippines) (English): +63-2-438-0090 China (Chinese): 10800-163-0014 (toll-free)
Homepage	http://www.pixela.co.jp/oem/jvc/mediabrowser/e/

- For details on how to use the software, refer to "MediaBrowser Help" in the "Help" menu of Everio MediaBrowser 4.

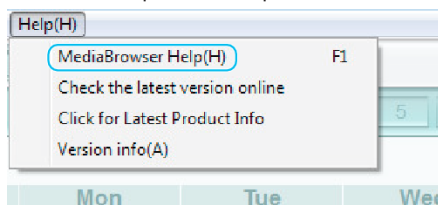

Verifying System Requirements (Guideline)

Right-click on "Computer" (or "My Computer") in the "Start" menu and select "Properties" to check the following items.

Windows Vista/Windows 7

- Refer to the operating instructions found in the animation on the Detailed User Guide.

Windows XP

- Refer to the operating instructions found in the animation on the Detailed User Guide.

	Windows Vista/Windows 7	Windows XP
OS	Windows Vista 32/64-bit Home Basic or Home Premium (Pre-installed versions only) Service Pack 2 Windows 7 32/64-bit Home Premium (Pre-installed versions only) Service Pack 1	Windows XP Home Edition or Professional (Pre-installed versions only) Service Pack 3
CPU	Intel Core Duo, CPU 1.66 GHz or higher (Intel Core 2 Duo, CPU 2.13 GHz or higher recommended)	Intel Core Duo, CPU 1.66 GHz or higher (Intel Core 2 Duo, CPU 2.13 GHz or higher recommended)
RAM	At least 2 GB	At least 1 GB
Video editing	Intel Core i7, CPU 2.53 GHz or higher recommended	Intel Core i7, CPU 2.53 GHz or higher recommended

Other requirements

Display: 1024×768 pixels or above (1280×1024 pixels or above recommended)

Graphic: Intel G965 or higher recommended

Memo :

- If your PC does not meet the above system requirements, operations of the provided software cannot be guaranteed.
- There is no guarantee that the operations will work with all computer environments.
- For more information, contact your PC's manufacturer.

Installing the Provided Software (Built-in)

You can display the recorded images in calendar format and perform editing using the provided software.

Preparations

Connect this unit to a computer with a USB cable.

- 1 Remove the AC adapter and battery pack from this unit.
- 2 Open the LCD monitor.

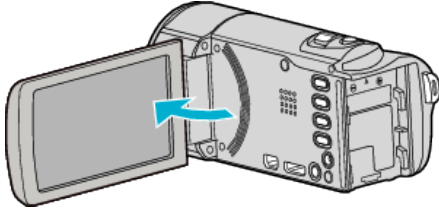

- 3 Connect the USB cable and the AC adapter.

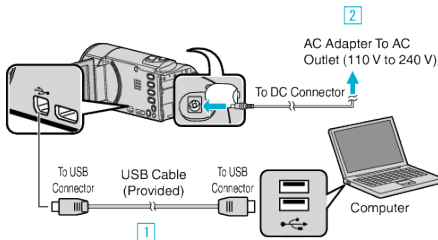

- 1 Connect using the provided USB cable.
 - 2 Connect the AC adapter to this unit.
- This unit powers on automatically when the AC adapter is connected.
 - Be sure to use the supplied AC adapter.
- 3 The “SELECT DEVICE” menu appears.
- 4 Tap “CONNECT TO PC”.



- 5 Tap “PLAYBACK ON PC”.

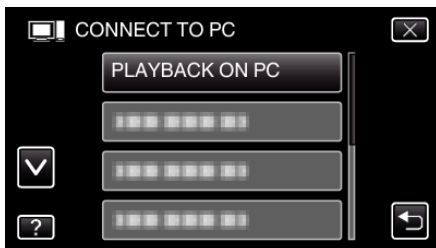

- Tap X to exit the menu.
- Tap ↶ to return to the previous screen.
- “Everio Software Setup” appears on the computer. Operations are to be performed on the computer after the screen switches.

Memo :

- If “Everio Software Setup” doesn’t appear, double-click “JVCCAM_APP” in “My Computer” or “Computer”, then double-click “install (or Install.exe)” .
- If the auto play dialog box appears, select “Open folder to view files” and click “OK”. Then, click “install (or Install.exe)” in the folder.

Installation Procedure

Windows Vista/Windows 7

- Refer to the operating instructions found in the animation on the Detailed User Guide.

Windows XP

- Refer to the operating instructions found in the animation on the Detailed User Guide.

Backing Up All Files

Before making backup, make sure that enough free space is left in the computer's hard disk (HDD). Backup will not start if there is not enough free space.

- 1 Remove the AC adapter and battery pack from this unit.
- 2 Open the LCD monitor.

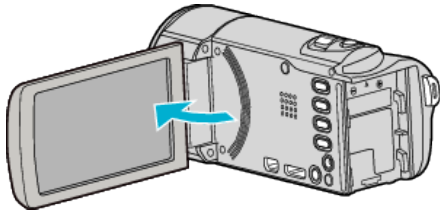

- 3 Connect the USB cable and the AC adapter.

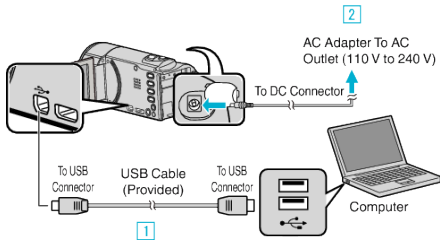

- 1 Connect using the provided USB cable.
 - 2 Connect the AC adapter to this unit.
- This unit powers on automatically when the AC adapter is connected.
 - Be sure to use the supplied AC adapter.
 - 3 The "SELECT DEVICE" menu appears.
- 4 Tap "CONNECT TO PC".



- 5 Tap "BACK UP".

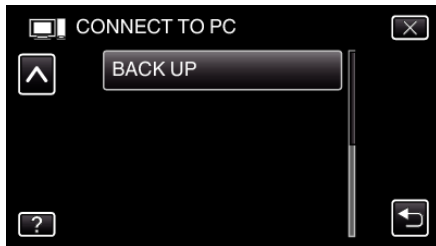

- Tap X to exit the menu.
- Tap ↶ to return to the previous screen.
- The provided software Everio MediaBrowser 4 starts up on the computer. The subsequent operations are to be performed on the computer.

- 6 Select the source of the image file.



Click "All volume in camcorder"

- 7 Start backup.

Saving Destination (PC)

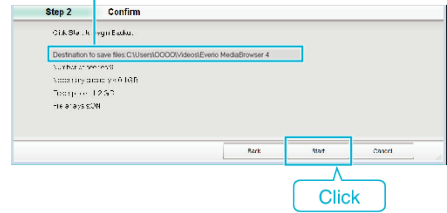

- Backup starts.

- 8 After backup is complete, click "OK".

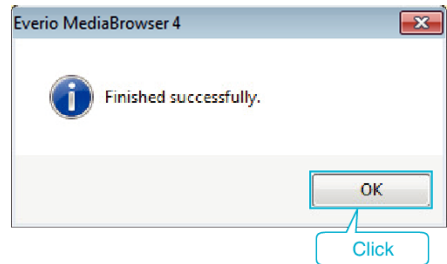

Memo :

- Before making backup, load the SD card in which the videos and still images are stored on this unit.
- If you encounter any problems with the provided software Everio MediaBrowser 4, please consult the "Pixela User Support Center".

Telephone	USA and Canada (English): +1-800-458-4029 (toll-free) Europe (UK, Germany, France, and Spain) (English/German/French/Spanish): +800-1532-4865 (toll-free) Other Countries in Europe (English/German/French/Spanish): +44-1489-564-764 Asia (Philippines) (English): +63-2-438-0090 China (Chinese): 10800-163-0014 (toll-free)
Homepage	http://www.pixela.co.jp/oem/jvc/mediabrowser/e/

- Delete unwanted videos before making backup. It takes time to back up many videos.

"Deleting Unwanted Files" (p. 82)

Disconnecting this Unit from Computer

- 1 Click "Safely Remove Hardware and Eject Media".

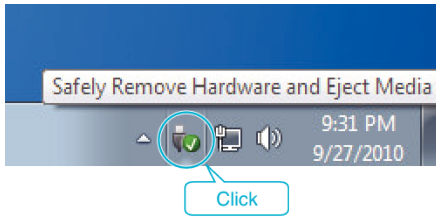

- 2 Click "Safely Remove USB Mass Storage Device".
- 3 (For Windows Vista) Click "OK".
- 4 Disconnect the USB cable and close the LCD monitor.

Organizing Files

After backing up your files, organize them by adding labels such as "Family Trip" or "Athletic Meet". This is useful not only for creating discs, but for viewing the files too.

- 1 Double-click on the Everio MediaBrowser 4 icon.
 - The provided software starts up.



- 2 Display the month of the files to organize.

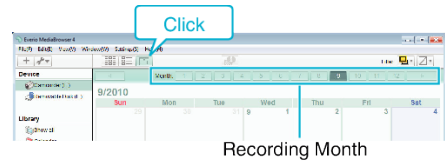

- 3 Create a user list.

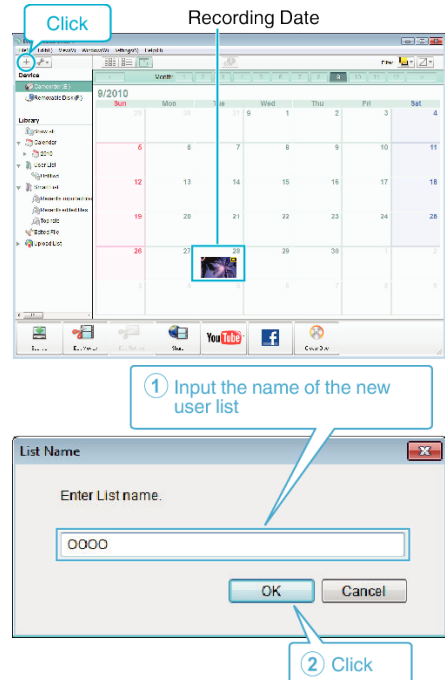

- A new user list is added to the user list library.

- 4 Click on the recording day.
 - The thumbnails of the files recorded on the day are displayed.

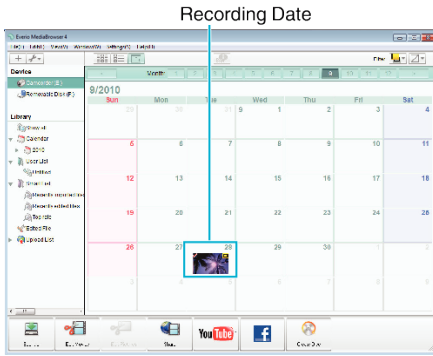

- 5 Register files to the created user list.

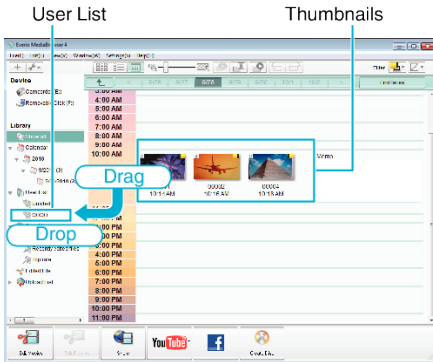

Identifying Video or Still Image:

- You can select files using the “SELECT” menu on the top right of the screen.
- Check the video/still image icon on the top right corner of the thumbnail.



Memo :

- If you encounter any problems with the provided software Evere MediaBrowser 4, please consult the “Pixela User Support Center”.

Telephone	USA and Canada (English): +1-800-458-4029 (toll-free) Europe (UK, Germany, France, and Spain) (English/German/French/Spanish): +800-1532-4865 (toll-free) Other Countries in Europe (English/German/French/Spanish): +44-1489-564-764 Asia (Philippines) (English): +63-2-438-0090 China (Chinese): 10800-163-0014 (toll-free)
Homepage	http://www.pixela.co.jp/oem/jvc/mediabrowser/e/

Recording Videos to Discs

Copy the files that are arranged using the user list to discs.

- 1 Insert a new disc into the PC’s recordable DVD drive.
- 2 Select the desired user list.

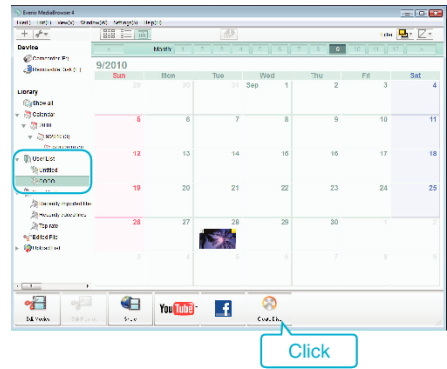

- 3 Select the disc type.

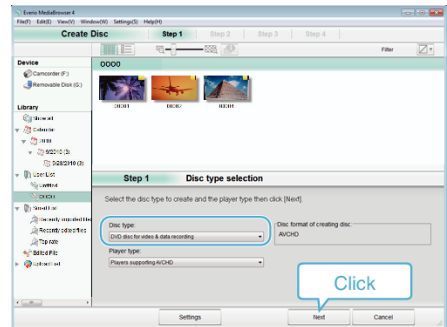

- 4 Select the files to copy to disc in order.

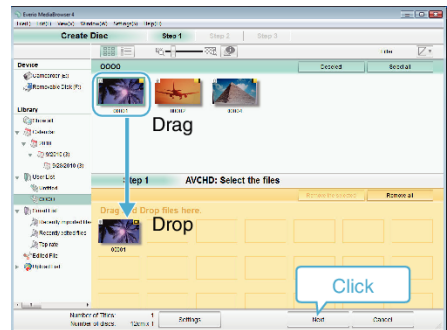

- Click “Settings” to select the disc type.
- Click “Select all” to select all the displayed files.
- After selecting, click “Next”.

- 5 Set the title of the top menu of the disc.

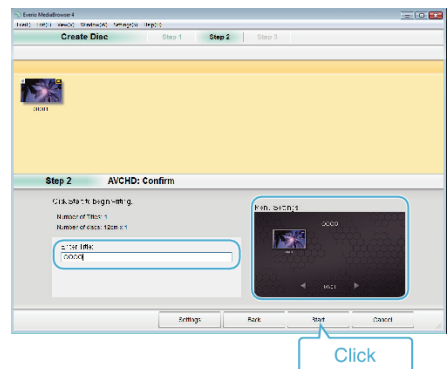

- Click “Settings” to select the menu background.
- After setting, click “Start”.

- 6 After copying is complete, click “OK”.

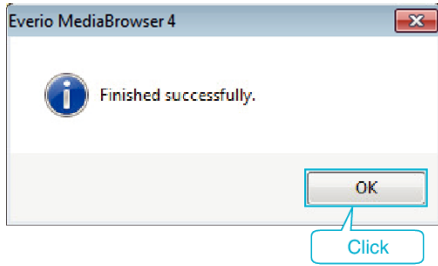

Memo :

- The following types of discs can be used on the provided software Everio MediaBrowser 4.
DVD-R
DVD-R DL
DVD-RW
DVD+R
DVD+R DL
DVD+RW

- The following formats are supported by the provided software Everio MediaBrowser 4.
AVCHD
DVD-Video*

*To create DVD-Video discs, it is necessary to install the additional software. For details, refer to the Pixela homepage.

<http://www.pixela.co.jp/oem/jvc/mediabrowser/e/>

- Use Everio MediaBrowser 4 Player to play back an AVCHD disc. Refer to the help file of the provided Everio MediaBrowser 4 software to operate.
- When copying videos recorded in UXP recording mode to create an AVCHD disc, the videos need to be converted to XP recording mode before copying. Therefore, it may take a longer time than copying videos recorded in other modes.
- To view the help file of Everio MediaBrowser 4, select "Help" from the Everio MediaBrowser 4's menu bar or press F1 on the keyboard.
- If you encounter any problems with the provided software Everio MediaBrowser 4, please consult the "Pixela User Support Center".

Telephone	USA and Canada (English): +1-800-458-4029 (toll-free) Europe (UK, Germany, France, and Spain) (English/German/French/Spanish): +800-1532-4865 (toll-free) Other Countries in Europe (English/German/French/Spanish): +44-1489-564-764 Asia (Philippines) (English): +63-2-438-0090 China (Chinese): 10800-163-0014 (toll-free)
Homepage	http://www.pixela.co.jp/oem/jvc/mediabrowser/e/

Backing Up Files Without Using Provided Software

Copy the files to a computer using the following method.

- 1 Remove the AC adapter and battery pack from this unit.
- 2 Open the LCD monitor.

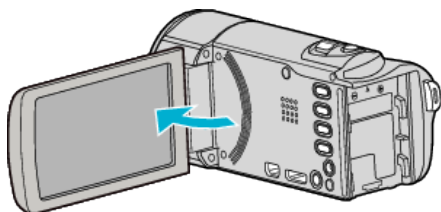

- 3 Connect the USB cable and the AC adapter.

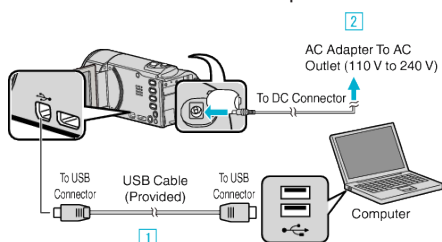

- 1 Connect using the provided USB cable.
- 2 Connect the AC adapter to this unit.

- This unit powers on automatically when the AC adapter is connected.
- Be sure to use the supplied AC adapter.
- 3 The "SELECT DEVICE" menu appears.

- 4 Tap "CONNECT TO PC".



- 5 Tap "PLAYBACK ON PC".

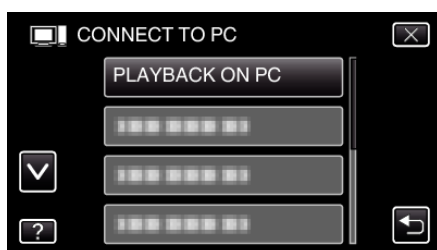

- Tap X to exit the menu.
- Tap ↶ to return to the previous screen.
- Close the Everio MediaBrowser 4 program, if it starts.
- The following screen is displayed after the camera operation is completed.

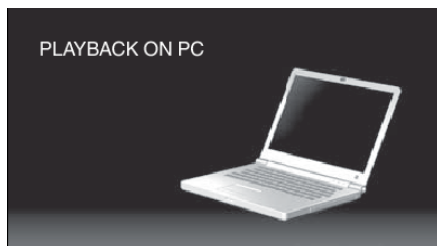

- Operations are to be performed on the computer after the screen switches.

- 6 Select "Computer" (Windows Vista)/"My Computer" (Windows XP)/"Computer" (Windows 7) from the "Start" menu, then click on the "JVCCAM_SD" icon.
 - Open the folder with the desired files.
 - "List of Files and Folders" (see p. 108)
- 7 Copy the files to any folder in the computer (desktop, etc).

Caution :

- When the camera and PC are connected by an USB cable, recorded media are read-only.

Memo :

- To edit/view the files, use a software that supports AVCHD (video)/JPEG (still image) files.
- The above operations on computer may vary with the system used.

Disconnecting this Unit from Computer

- 1 Click "Safely Remove Hardware and Eject Media".

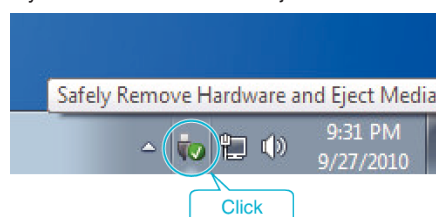

- 2 Click "Safely Remove USB Mass Storage Device".
- 3 (For Windows Vista) Click "OK".
- 4 Disconnect the USB cable and close the LCD monitor.

Copying

List of Files and Folders

Folders and files are created in the SD card as shown below.
They are created only when necessary.

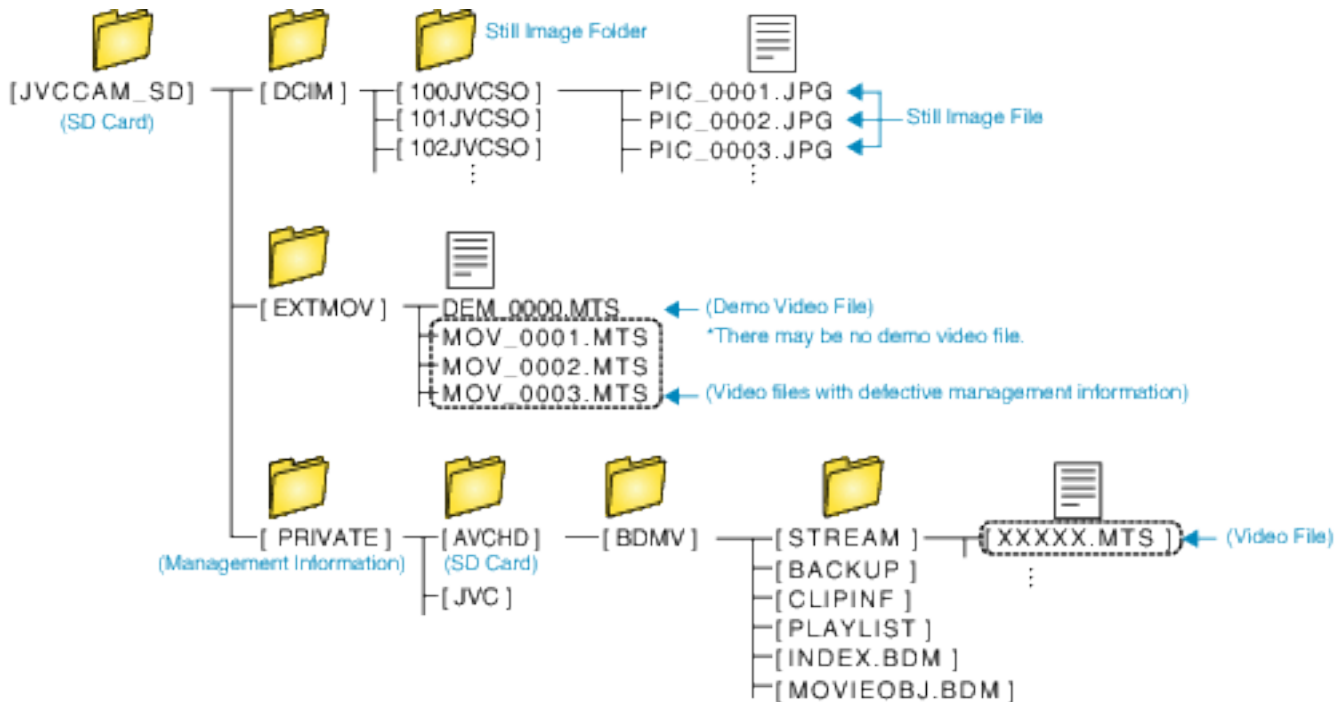
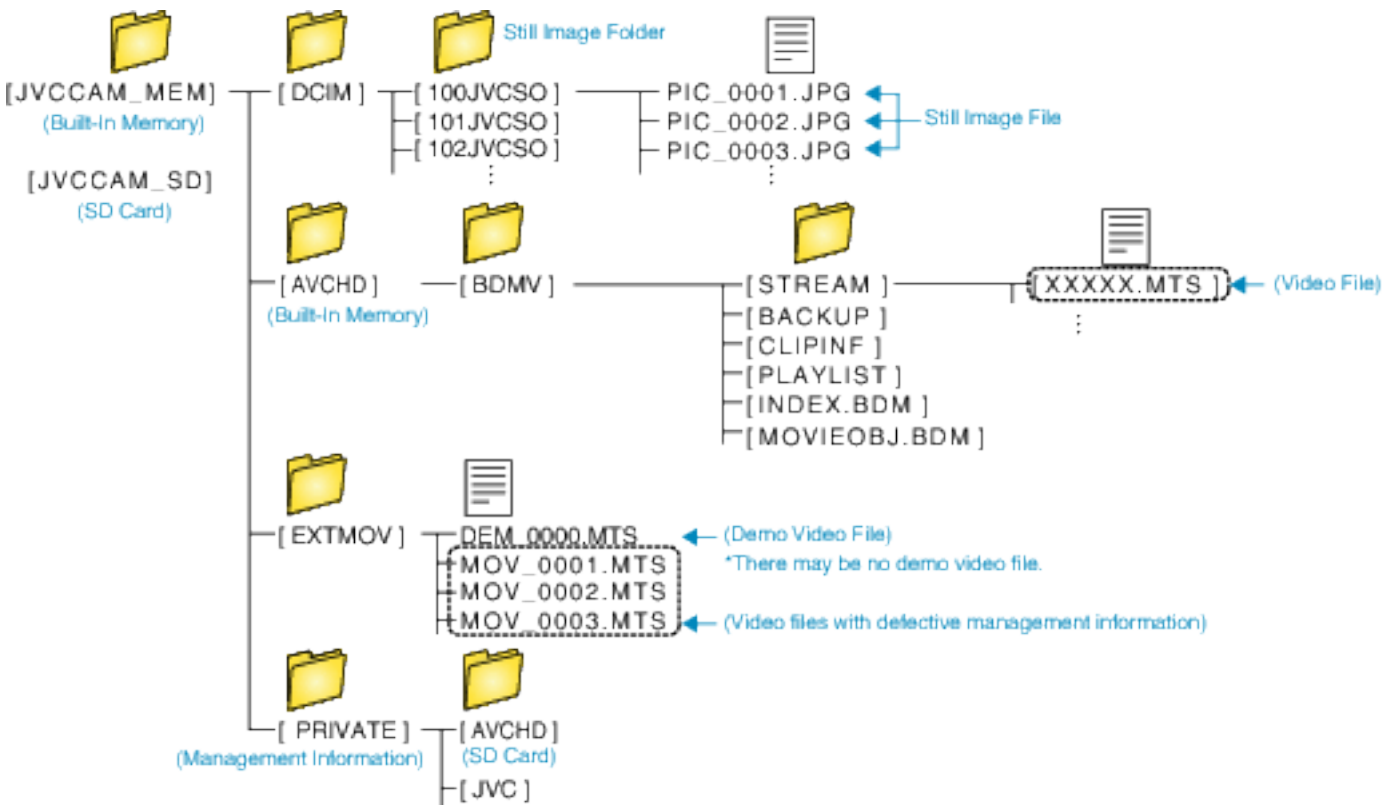

Caution :

- When the camera and PC are connected by a USB cable, recorded media are read-only.

Copying to Mac Computer

Copy the files to a Mac computer using the following method.

- 1 Remove the AC adapter and battery pack from this unit.
- 2 Open the LCD monitor.

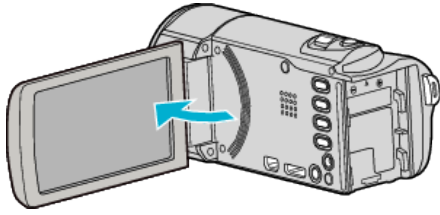

- 3 Connect the USB cable and the AC adapter.

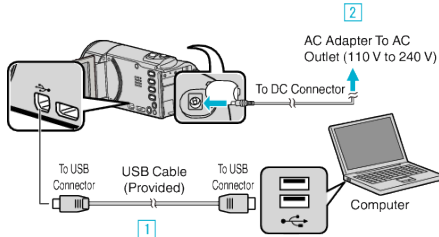

- 1 Connect using the provided USB cable.
 - 2 Connect the AC adapter to this unit.
- This unit powers on automatically when the AC adapter is connected.
 - Be sure to use the supplied AC adapter.
 - 3 The "SELECT DEVICE" menu appears.
- 4 Tap "CONNECT TO PC".



- 5 Tap "PLAYBACK ON PC".

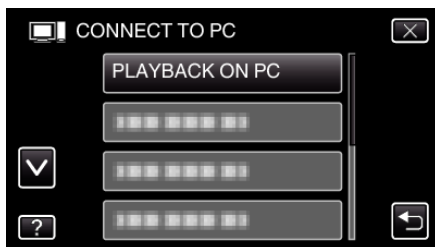

- Tap X to exit the menu.
- Tap ↶ to return to the previous screen.
- The following screen is displayed after the camera operation is completed.

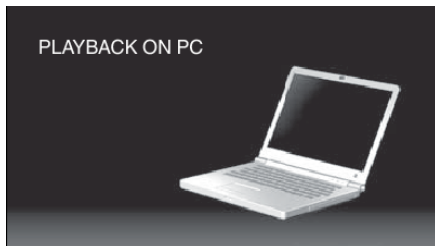

- The "JVCCAM_SD" icon appears on the desktop.

- 6 Start iMovie.
 - The subsequent operations are to be performed on the Mac computer.

Caution :

- When the camera and PC are connected by a USB cable, recorded media are read-only.
- MTS files that are copied to a Mac computer cannot be imported to iMovie. To use MTS files with iMovie, import the files using iMovie.

Memo :

- To edit/view the files, use a software that supports iFrame (video)/ AVCHD (video)/JPEG (still image) files.
- When removing this unit from the computer, drag & drop the "JVCCAM_SD" icon on the desktop to the trash bin.

iMovie and iPhoto

You can import files from this unit to a computer using Apple's iMovie'08, '09, '11 (video) or iPhoto (still image).

To verify the system requirements, select "About This Mac" from the Apple menu. You can determine the operating system version, processor and amount of memory.

- For the latest information on iMovie or iPhoto, refer to the Apple website.
- For details on how to use iMovie or iPhoto, refer to the help file of the respective softwares.
- There is no guarantee that the operations will work with all computer environments.

Wi-Fi Capabilities

This unit is equipped with Wi-Fi function.

You can do the following using a smartphone or computer via wireless connection.

Name of Function	Capability
DIRECT MONITORING	<ul style="list-style-type: none"> You can check the image on the camera via direct 1-to-1 connection (Wi-Fi Direct) with a smartphone (or computer), without the need for an access point (wireless LAN router). Recording of videos and still images may be performed while monitoring. (Videos and still images cannot be recorded while monitoring from the computer browser.) “Image Monitoring via Direct Connection (DIRECT MONITORING)” (☞ p. 112)
INDOOR MONITORING	<ul style="list-style-type: none"> Connect to the smartphone (or PC) via access point at home using the wireless LAN router, to monitor images captured by the camcorder. Recording of videos and still images may be performed while monitoring. (Videos and still images cannot be recorded while monitoring from the computer browser.) “Image Monitoring via an Access Point at Home (INDOOR MONITORING)” (☞ p. 115)
OUTDOOR MONITORING	<ul style="list-style-type: none"> You can check the image on the camera via internet connection with a smartphone (or computer) while you are outside. Recording of videos and still images may be performed while monitoring. (Videos and still images cannot be recorded while monitoring from the computer browser.) “Image Monitoring via the Internet (OUTDOOR MONITORING)” (☞ p. 120)
DETECT/MAIL	<ul style="list-style-type: none"> A still image is automatically captured and sent via e-mail when faces or movements are detected by the camera. You can also set to record videos on the camera during detection. “Sending Still Images via E-mail upon Detection of Face or Movement (DETECT/MAIL)” (☞ p. 123)
VIDEO MAIL	<ul style="list-style-type: none"> Videos of up to 15 seconds can be recorded and sent via e-mail. “Record and Send Videos via E-mail (VIDEO MAIL)” (☞ p. 124)
TV MONITORING	<ul style="list-style-type: none"> Connect this unit to the DLNA compatible TV via access point at home using the wireless LAN router.
EASY STORAGE	<ul style="list-style-type: none"> Save all the videos and still images that have not backed up to your computer, which is connected via wireless network. The management file is saved as well.
Record of the location information	<ul style="list-style-type: none"> You can record the location information of the venue where recording is taking place via direct connection (Wi-Fi Direct) with a smartphone supporting the GPS function. The recorded location information can be used on the software provided with this unit. “Recording the Location Information” (☞ p. 128)
Pan Cradle (sold separately)	<ul style="list-style-type: none"> Panning operation (changing the camera to the left/right direction) can be remotely controlled via smartphone by setting the camera on the pan cradle (sold separately). “Using the Pan Cradle (Sold Separately)” (☞ p. 131) For how to connect the pan cradle, refer to the instruction manual of the Pan Cradle for further details.

Terms Used in this Guide: _____

- In this guide, operations on the touch panel are described as “tap”.
- While the names of the buttons on a smartphone are written as “MENU” or “RETURN”, they may vary according to the smartphone in use.

Refer also to the instruction manual of your smartphone.

Operating Environment

To check the image on the camera from a computer or smartphone, and to transfer videos/still images, it is necessary to meet the following requirements.

Android Smartphone and Tablet Device

- 1 OS: Android2.3 or higher
(This unit is not guaranteed to operate with all models.)
- 2 Supports GPS function (for GPS recording)
- 3 Able to connect to the internet or Google Play ("Everio sync. 2" required for software installation)

iPhone/iPad/iPod touch

- 1 OS: iOS5.1 or higher
(This unit is not guaranteed to operate with all models.)
- 2 Able to connect to the internet or "App Store™" (required for software installation)

Computer

To check the image on the camera from a computer browser and to transfer videos/still images, it is necessary to meet the following requirements.

- 1 OS: Windows 7
 - 2 Supports wireless LAN or wired LAN
(To connect the camera and computer directly by using the DIRECT MONITORING function, support for wireless LAN is required.)
 - 3 Installation of Windows Media Player 12 or later
- Confirmed operating environment:
Internet Explorer 9 or later

Caution :

- There is no guarantee that the operations will work with all computer environments. For example, the video download feature of mobile safari browser, etc. is not supported.

Precautions on Using Wi-Fi

Cautions on Wi-Fi Function

- Operation is not guaranteed on all devices.
- This function is not designed for disaster or crime prevention.
- To prevent the situation of forgetting to turn off the power, this unit will turn off automatically after 10 days of continuous usage.
- Leaving the LCD monitor open makes it easier to receive radio waves. Therefore, it is recommended to open the LCD monitor when using the Wi-Fi function.
- Security of Wireless LAN
An advantage of wireless LAN is that instead of using a LAN cable, it transmits information using radio waves, thus enabling LAN connection to be established within the area covered by the radio waves. However, as radio waves penetrate through objects (such as walls) within the range that they cover, security issues, such as interception of transmission or illegal access, may arise if security settings are not configured. Before you connect to the network in a wireless LAN environment, read through the instruction manual for the wireless LAN device in use, and configure the security settings accordingly. Failure to do so may increase the risk of personal information being intercepted, such as user names, passwords, and the content of your mails, or illegal access to the network.
- Due to the design of wireless LAN, note that security may be breached by unusual or unforeseeable means.
- For more details on wireless LAN and network security, please consult the manufacturer of your wireless LAN device.
- JVC shall not be liable for any security issues, troubles, damages or losses arising from the use of this feature.

Radio Waves Used by this Product

This product makes use of radio waves in the ISM band (2.4 GHz). Although a radio station license is not required for using this product, please take note of the following.

■ Do not use this product near the following places.

- Industrial, scientific, or medical equipment, such as microwave ovens and pacemakers
- Industrial, scientific, or medical equipment, such as microwave ovens and pacemakers
- Specified low-power radio stations (radio station license not required)
- Bluetooth devices

Equipment such as the above mentioned devices makes use of the same frequency bandwidth as that of Wi-Fi. Using this product near the above equipment may cause radio wave interference, and result in communication failure or a drop in communication speed. In this case, turn off the power of devices that are not in use.

■ Avoid using this product near a TV or radio set.

TV or radio sets make use of a radio wave frequency bandwidth that is different from that of Wi-Fi, and therefore has no effect on communication by this product or the TV/radio set.

However, when a TV/radio set is placed close to a Wi-Fi product, electromagnetic waves emitted by the Wi-Fi product may cause noise to occur in the sound or images of the TV/radio.

- Communication may not be carried out properly near radio equipment or broadcasting stations. In this case, change the location accordingly.

■ Radio signals are unable to penetrate through reinforced steel, metal, or concrete.

The radio waves used by this product are unable to penetrate through reinforced steel, metal, or concrete materials. It may difficult for communication to be established if two rooms or floors are separated by these materials.

*Communication may also get weaker when there are human subjects or parts of the body in between the Wi-Fi devices.

■ Do not connect to wireless networks that you do not have authorization for.

Once connected, it may be considered as unauthorized access and legal actions can be taken against you.

■ Do not use the Wi-Fi function outside the country of purchase.

Depending on the country, there may be restrictions on the use of radio waves and any violations could be punishable by law.

Exporting/Bringing the Unit Overseas

Permission from the U.S. government may be required when bringing the unit to an export controlled country set by the U.S. government (such as Cuba, Iraq, North Korea, Iran, Rwanda, and Syria. As of December, 2012). For more information, consult the U.S. Embassy Commercial Service.

Image Monitoring via Direct Connection (DIRECT MONITORING)

You can check the image on the camera via direct connection (Wi-Fi Direct) with a smartphone (or computer), without the need for an access point (wireless LAN router).

- Recording of videos and still images may be performed while monitoring.

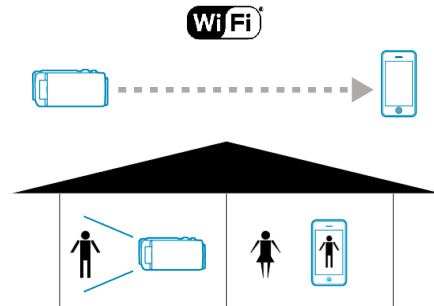

Caution :

- This function is not designed for disaster or crime prevention.
- To prevent the situation of forgetting to turn off the power, this unit will turn off automatically after 10 days of continuous usage.
- When not monitoring from a smartphone (or computer), the focus of the camera is fixed.
- Even when monitoring from a smartphone (or computer), the focus of the camera will be fixed if not operated for more than 3 hours. (Focus works again when the camera is operated.)
- You may have difficulty establishing a connection via direct monitoring in an environment where the camera is placed away from the smartphone (or computer). In this case, connect using the access point (wireless LAN router).

“Image Monitoring via an Access Point at Home (INDOOR MONITORING)”
(p. 115)

- Depending on the device in use or connecting environment, it may take some time to establish a connection.

What You Need

- Smartphone or Windows computer
(A wireless LAN that is compatible with WPA2 is necessary.)

Settings Required in Advance

Set up your camera and smartphone (or computer) by performing the following operations.

For a smartphone with WPS support, refer to the “Wi-Fi Protected Setup (WPS)”.

*WPS is a method to connect the camera and the smartphone wirelessly by easy button operations.

Connecting the Smartphone to the Camera Wirelessly

Connect the smartphone to the camera by either of the following methods.

■ Connection by entering the Wi-Fi password

- 1 Tap "MENU".
(Operation on this camera)
Set the camera to the recording mode.

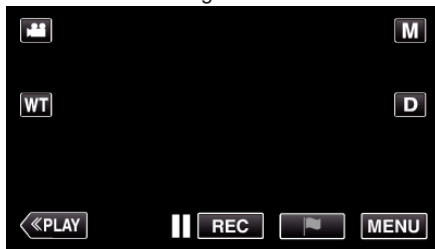

- The top menu appears.

- 2 Tap the "Wi-Fi" (Wi-Fi icon).
(Operation on this camera)

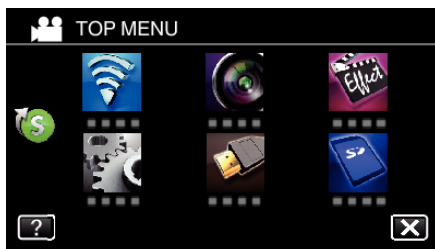

- 3 Tap the "DIRECT MONITORING" (DIRECT MONITORING icon) in the "Wi-Fi" menu.
(Operation on this camera)



- 4 Tap "START" (START icon).
(Operation on this camera)



- When iFrame is selected for "VIDEO REC FORMAT", the following display appears and recording mode is switched to the 50i mode in AVCHD.



- 5 Check the SSID and the PASS being displayed on the screen of the camera.



- 6 Select the SSID in step 5 from the Wi-Fi network selection screen of your smartphone, and enter the PASS on the password screen.
(Operation on the smartphone (or computer))



- For details on connecting your smartphone (or computer) to a Wi-Fi network, please refer to the instruction manual of the phone terminal in use.

- 7 A connection is established and Wi-Fi appears on the camera's screen.



■ Connection by Wi-Fi Protected Setup (WPS)

- 1 Tap "MENU".
(Operation on this camera)
Set the camera to the recording mode.

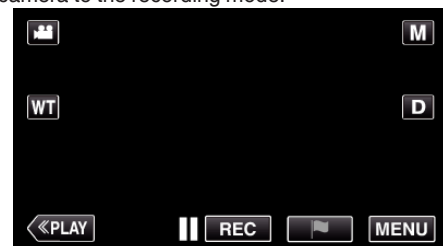

- The top menu appears.

- 2 Tap the "Wi-Fi" (Wi-Fi icon).
(Operation on this camera)

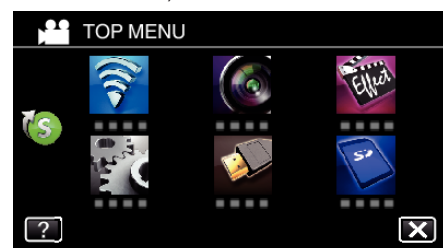

- 3 Tap the "DIRECT MONITORING" (DIRECT MONITORING icon) in the "Wi-Fi" menu.
(Operation on this camera)



- 4 Tap "START" (→).
(Operation on this camera)

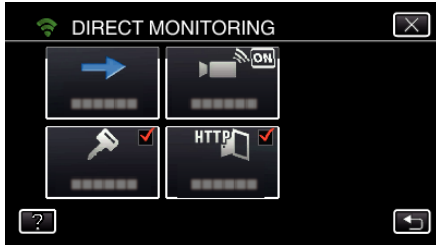

- When iFrame is selected for "VIDEO REC FORMAT", the following display appears and recording mode is switched to the 50i mode in AVCHD.

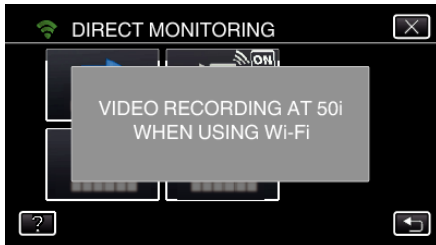

- 5 Tap "WPS".
(Operation on this camera)



- 6 Activate WPS on the smartphone (or computer) within 2 minutes.
(Operation on the smartphone (or computer))



- To activate WPS, refer to the instruction manual of the device in use.

- 7 A connection is established and  appears on the camera's screen.



Monitoring the Images from a Smartphone (or Computer)

Smartphone (Android / iPhone)

Memo : _____

- Prior to use this function, a smartphone application needs to be installed on the smartphone.

"Installing Smartphone Applications" (p. 156)

- 1 Start "Everio sync. 2" on the smartphone after setting DIRECT MONITORING.



- 2 Tap "DIRECT MONITORING".



- 3 The recording screen is displayed.



- How to operate from a smartphone
“Using Smartphone Applications” (p. 156)

■ Computer (Windows 7)

- 1 Tap the URL button shown on the camera's screen.
(displayed when the computer and the camera are connected wirelessly.)



- The URL for the computer to connect to appears.
- 2 Check the URL being displayed on the camera screen, which starts from “http://”.



- After checking the URL, tap “QUIT” to return to the previous screen.
- 3 Start Internet Explorer (web browser) on the computer and enter the URL.

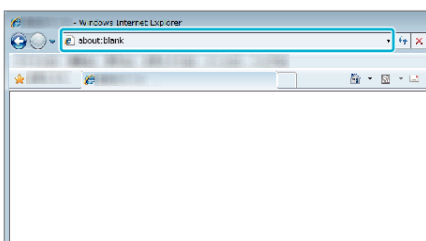

- Operations from the Web browser
“Using the Wi-Fi Function from a Web Browser” (p. 169)

Image Monitoring via an Access Point at Home (INDOOR MONITORING)

Connect to the wireless LAN router at home, the camera and a smartphone (or computer) via access point wirelessly.
From a smartphone (or computer) in connection, you can monitor the images captured by the camera.

- Recording of videos and still images may be performed while monitoring.

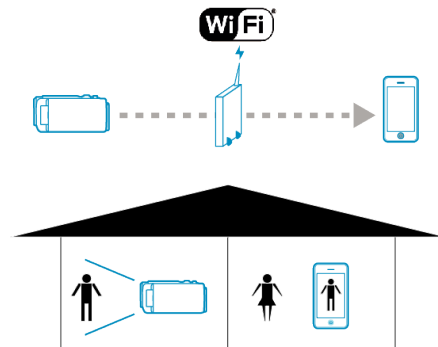

Caution :

- This function is not designed for disaster or crime prevention.
- To prevent the situation of forgetting to turn off the power, this unit will turn off automatically after 10 days of continuous usage.
- When not monitoring from a smartphone (or computer), the focus of the camera is fixed.
- Even when monitoring from a smartphone (or computer), the focus of the camera will be fixed if not operated for more than 3 hours. (Focus works again when the camera is operated.)

What You Need

- Smartphone or Windows computer
- Wireless LAN router (use a product that has a Wi-Fi certification logo)

Memo :

- Depending on the wireless LAN router in use and signal strength, you may experience connection problems or slow connections.

Operation Method

Connect the camera to the access point (wireless LAN router)



Connect the camera to the access point by either of the following methods.

■ Wi-Fi Protected Setup (WPS) Registration

Follow the operations below if the access point (wireless LAN router) in use supports WPS.

- 1 Tap "MENU".
(Operation on this camera)



- The top menu appears.

- 2 Tap the "Wi-Fi" (Wi-Fi icon).
(Operation on this camera)

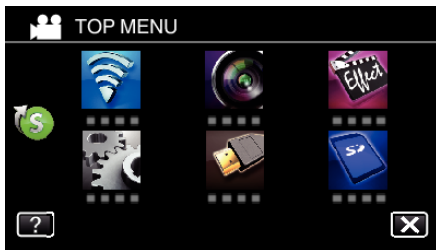

- 3 Tap > on the lower right of the screen.
(Operation on this camera)

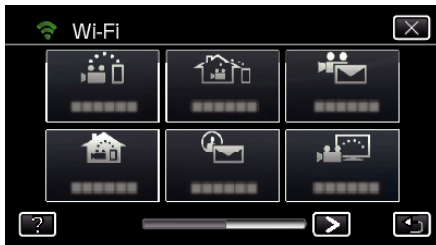

- 4 Tap "COMMON Wi-Fi SETTING".
(Operation on this camera)



- 5 Tap "ACCESS POINTS".
(Operation on this camera)



- 6 Tap "ADD".
(Operation on this camera)

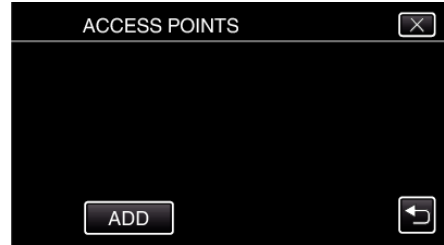

- 7 Tap "EZ REGISTRATION WPS".
(Operation on this camera)

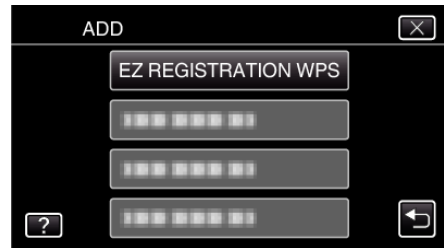

- 8 Activate WPS of the access point (wireless LAN router) within 2 minutes.
 - To activate WPS, refer to the instruction manual of the device in use.
- 9 After registration is complete, tap "OK" on the camera's screen.
(Operation on this camera)



■ Search the access point, and select from the list.

Set the name (SSID) of the access point (wireless LAN router) and the password beforehand.

- 1 Tap "MENU".
(Operation on this camera)



- The top menu appears.

- 2 Tap the "Wi-Fi" (Wi-Fi icon).
(Operation on this camera)

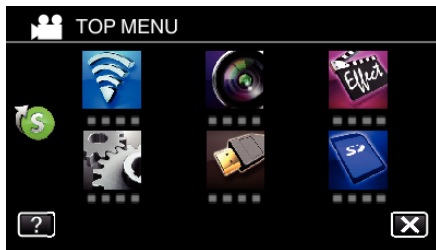

- 3 Tap > on the lower right of the screen.
(Operation on this camera)



- 4 Tap "COMMON Wi-Fi SETTING".
(Operation on this camera)



- 5 Tap "ACCESS POINTS".
(Operation on this camera)

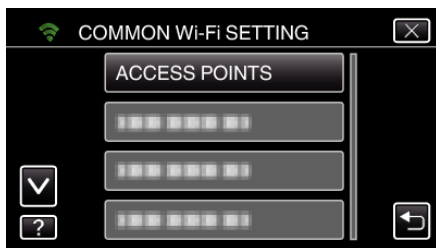

- 6 Tap "ADD".
(Operation on this camera)



- 7 Tap "SEARCH".
(Operation on this camera)

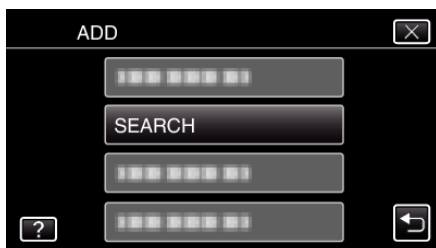

- The search results appear on the camera's screen.
- "UNABLE TO FIND THE ACCESS POINT" message appears if there is no access point in the surrounding area.

- 8 Tap the name (SSID) of the desired access point from the list of search results.
(Operation on this camera)

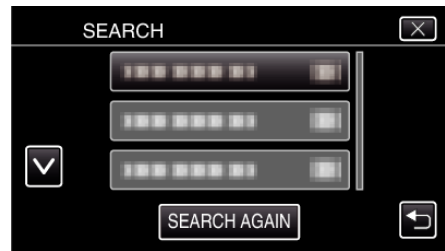

- 9 Register a password.
(Operation on this camera)



- Tap on the on-screen keyboard to enter characters. The character changes with every tap. "ABC", for example, enter "A" by tapping once, "B" by tapping twice, or "C" by tapping 3 times.
- Tap "DELETE" to delete a character.
- Tap "CANCEL" to exit.
- Tap "A/a/1" to select character input type from upper case letter, lower case letter, and number.
- Tap ← or → to move one space to the left or right.
- The password is not required if the wireless LAN router is not security protected.

- 10 After registration is complete, tap "OK" on the camera's screen.
(Operation on this camera)



- Other methods, such as "Manual Registration" and "WPS PIN Registration" are also available. Refer to the following link for details. "Registering the Access Points of the Camera to Connect (ACCESS POINTS)" (p. 145)

Connecting the smartphone (or computer) to the access point (wireless LAN router)



- Connect the smartphone (or computer) to the access point (wireless LAN router) at home.
- For details on connections, refer to the instruction manuals of the device in use or the wireless LAN router.
- This setting is unnecessary if the smartphone (or computer) has already been connected to the access point (wireless LAN router) at home.

Monitoring the images by connecting the smartphone and the camera



- Install “Everio sync. 2” on the smartphone in advance.
“Installing Smartphone Applications” (p. 156)

■ Operation on this camera

- 1 Tap “MENU”.
(Operation on this camera)



- The top menu appears.

- 2 Tap the “Wi-Fi” (Wi-Fi icon).
(Operation on this camera)

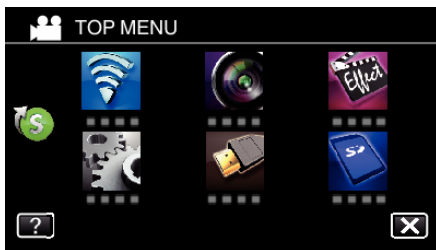

- 3 Tap “INDOOR MONITORING” (house icon).
(Operation on this camera)

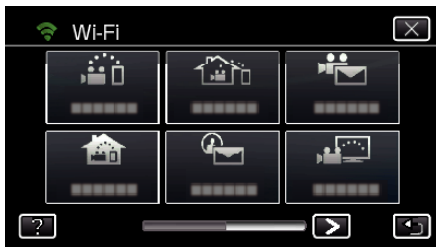

- 4 Tap “START” (right arrow).
(Operation on this camera)

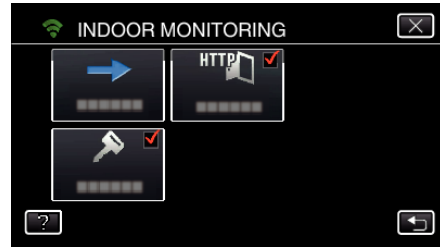

- 5 Start making a connection.
(Operation on this camera)



- Name (SSID) of the access point (wireless LAN router) in connection is displayed.

- 6 The following is displayed when the camera is connected to the access point.



- Tap “URL” to display the URL required for connecting the camera from browser.

■ Operation on the smartphone

- 1 Start “Everio sync. 2” on the smartphone after setting INDOOR MONITORING.



- Tap “START” in INDOOR MONITORING on the camera to start.

- 2 Tap “INDOOR MONITORING”.



- 3 Log in with your username and password.
(if authentication cannot be achieved)

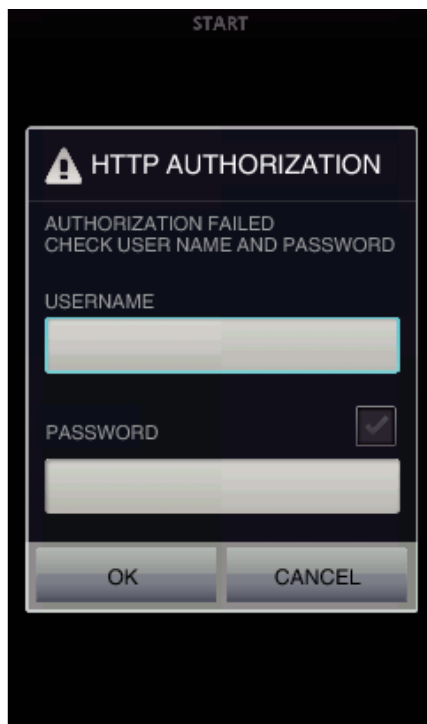

- The username is "everio" and the default password is "0000".
"Changing the Settings" (p. 134)

- 4 The recording screen is displayed.



- How to operate from a smartphone
"Using Smartphone Applications" (p. 156)

■ Monitoring from the computer (Windows7)

- 1 Tap the URL button shown on the camera's screen.
(displayed when the computer and the camera are connected wirelessly.)



- The URL for the computer to connect to appears.
- 2 Check the URL being displayed on the camera screen, which starts from "http://".

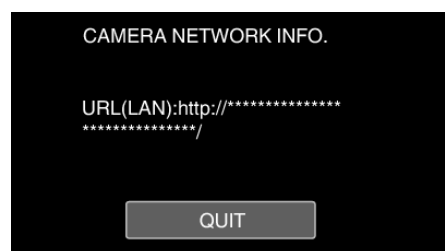

- After checking the URL, tap "QUIT" to return to the previous screen.
- 3 Start Internet Explorer (web browser) on the computer and enter the URL.

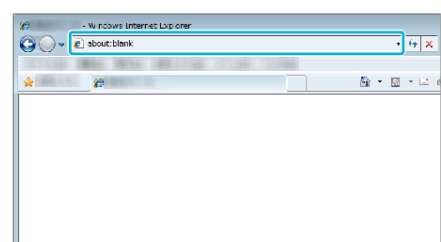

- 4 Log in with your username and password.
- The username is "everio" and the default password is "0000".
"Changing the Settings" (p. 134)
 - Operations from the Web browser

Image Monitoring via the Internet (OUTDOOR MONITORING)

You can check the image on the camera via internet connection with a smartphone (or computer).

* To use this function, it is necessary to prepare for an UPnP (Universal Plug and Play) compatible wireless LAN router, and an internet connection from which the global IP address can be obtained.

- Recording of videos and still images may be performed while monitoring.



Setting Multiple Cameras in the Same Network:

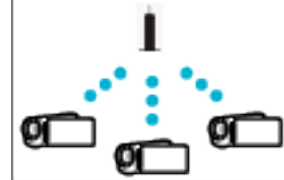

- To set up multiple cameras, you need to fix the HTTP ports for each of the cameras.

"Changing the HTTP Port (DIRECT MONITORING/INDOOR MONITORING/OUTDOOR MONITORING)" (☞ p. 137)

What You Need

- Smartphone or Windows computer
- Wireless LAN router that supports UPnP (use a product that has a Wi-Fi certification logo)

To check whether UPnP is supported, please refer to the instruction manual of the wireless LAN router in use.

- Internet connection with an obtainable global IP address

* Global IP address is an IP address that is specific in all over the internet. For more information, contact your internet service provider.

Memo :

- Depending on the wireless LAN router in use and signal strength, you may experience connection problems or slow connections.
- When the zoom or pan cradle is operated by using the smartphone or computer, it may take longer for responses as compared to the manual operations.

Settings Required in Advance

To operate, it is necessary to connect the camera to the internet via an access point (UPnP compatible wireless LAN router) in the house. As such, the following 3 settings are required.

*The above settings are not necessary if they have already been set for other functions.

1 Registering an access point

"Registering the Access Points of the Camera to Connect (ACCESS POINTS)" (☞ p. 145)

2 Obtaining a dynamic DNS account

"Obtaining a Dynamic DNS (DDNS) Account" (☞ p. 138)

3 Setting the account on this camera

"Setting Dynamic DNS on this Camera (OUTDOOR MONITORING)" (☞ p. 139)

Caution :

- Even if registration is done correctly to the camera, access may be temporarily unavailable such as when the dynamic DNS server is down. To check whether the dynamic DNS server is working properly, access and check the DDNS server with a computer, etc.

<https://dd3.jvckenwood.com/user/>

Operation Method

■ Operation on this camera

Memo :

- Prior to use this function, a smartphone application needs to be installed on the smartphone.

“Installing Smartphone Applications” (p. 156)

- 1 Tap “MENU”.
(Operation on this camera)



- The top menu appears.

- 2 Tap the “Wi-Fi” (Wi-Fi icon).
(Operation on this camera)

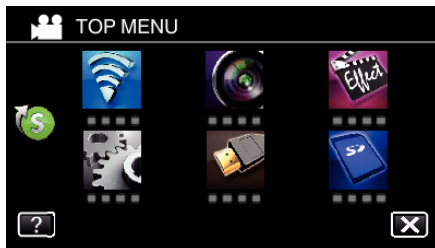

- 3 Tap “OUTDOOR MONITORING” (house with Wi-Fi icon).
(Operation on this camera)



- 4 Tap “START” (right arrow).
(Operation on this camera)



- 5 Start making a connection.
(Operation on this camera)



- Name (SSID) of the access point (wireless LAN router) in connection is displayed.

- 6 The following is displayed when the camera is connected to the access point.



- The URL (WAN) for the smartphone to connect to appears. (Does not appear if DDNS is not set or set incorrectly.)
- “XUPnP” is displayed when UPnP cannot be used.

- 7 Check the URL (WAN).



- After checking the URL, tap “QUIT” to return to the previous screen.
- “XUPnP” is displayed when UPnP cannot be used.

■ Operation on the smartphone

- 1 Start “Everio sync. 2” on the smartphone after setting “OUTDOOR MONITORING”.



- 2 Tap “OUTDOOR MONITORING”.



- 3 Log in with your username and password.
(if authentication cannot be achieved)

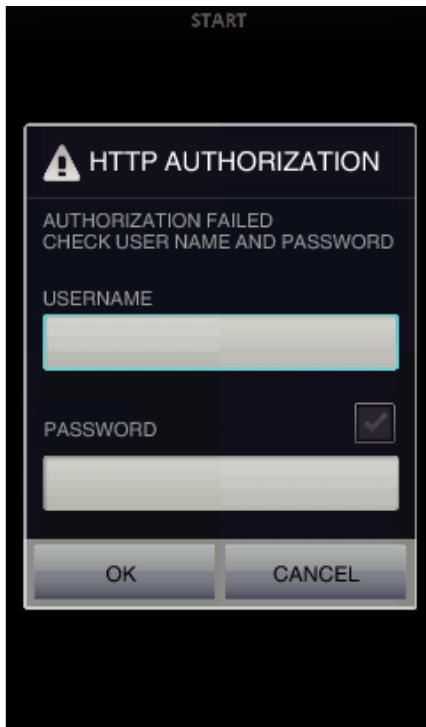

- The username is “everio” and the default password is “0000”.
“Changing the Settings” (☞ p. 134)

4 The recording screen is displayed.

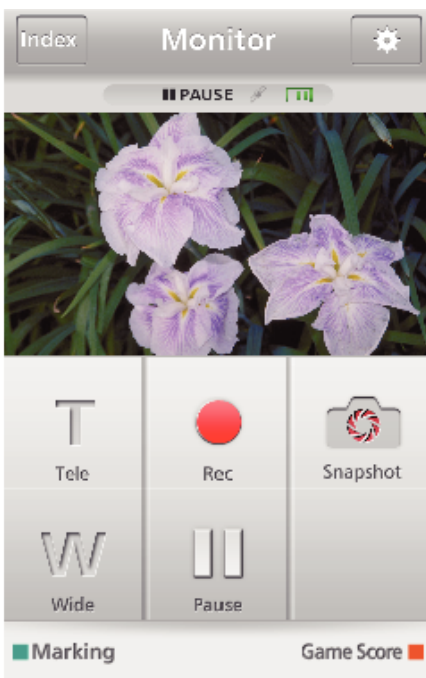

- How to operate from a smartphone
“Using Smartphone Applications” (☞ p. 156)

■ Monitoring from the computer (Windows7)

- 1 On the Internet Explorer (web browser), enter the URL (WAN) that is checked by “Operation on this camera”.

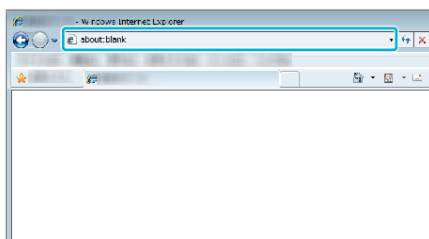

- 2 Log in with your username and password.

- The username is “everio” and the default password is “0000”.
“Changing the Settings” (☞ p. 134)
- Operations from the Web browser
“Using the Wi-Fi Function from a Web Browser” (☞ p. 169)

Caution :

- To monitor images while you are out, make sure in advance that you can establish a connection via the Internet by entering the URL (WAN) displayed in “Network Information”.
However, you cannot monitor (operate) in the same way as while you are out when your smartphone (or computer) is connected via access point (wireless LAN router) at home.
 - Start using after changing the password.
If the password is not changed, there is a high risk of unauthorized access from others.
Also, avoid using easily guessable passwords, such as birth dates.
You are recommended to change your password periodically.
- “Setting the Password (DIRECT MONITORING/INDOOR MONITORING/OUTDOOR MONITORING)” (☞ p. 136)
- There is no guarantee that the operations will work with all computer environments. For example, the video download feature of mobile safari browser, etc. is not supported.

Caution :

- Too much usage may cause high communication fees to be incurred, and there may be a limit to the volume of communication. For more details, please check your Internet or smartphone subscription.
- If the network connection is slow, video images may appear jumpy, or audio sound may be interrupted or delayed.
- This function is not designed for disaster or crime prevention.
- To prevent the situation of forgetting to turn off the power, this unit will turn off automatically after 10 days of continuous usage.
- When not monitoring from a smartphone (or computer), the focus of the camera is fixed.
- Even when monitoring from a smartphone (or computer), the focus of the camera will be fixed if not operated for more than 3 hours. (Focus works again when the camera is operated.)

Sending Still Images via E-mail upon Detection of Face or Movement (DETECT/MAIL)

A still image is automatically captured and sent via e-mail when faces or movements are detected by the camera.



Memo :

- Size of the still images shot by DETECT/MAIL is 640 x 360.
- Operation via connection to a smartphone (or computer) using "INDOOR MONITORING"/"OUTDOOR MONITORING" may be performed even during detection standby.
- When the camera is connected to a smartphone (or computer), "DETECT/MAIL SETTING" will be temporarily unavailable.
- You can set to record videos on this unit automatically during detection. "Recording on this unit" (☞ p. 134)
- To prevent too many e-mails from being sent in case of detections occurring frequently, you can set the interval of e-mail delivery. "Setting detection interval" (☞ p. 134)

What You Need

- Wireless LAN router (use a product that has a Wi-Fi certification logo)
- Internet connection
- Account for sending e-mails (Supports SMTP. E-mail services that is only accessible from the web cannot be used.)

Settings Required in Advance

To send e-mails, the following settings are required in advance.
*The above settings are not necessary if they have already been set for other functions.

1 Registering an access point

"Registering the Access Points of the Camera to Connect (ACCESS POINTS)" (☞ p. 145)

2 Setting the account for sending e-mails

"Setting the Sender's E-mail Address of the Camera" (☞ p. 140)

3. Registering the recipient's e-mail address for notification mails (up to 8 addresses)

"Registering the Recipient's E-mail Address of the Camera" (☞ p. 142)

Operation Method

1 Tap "MENU".

Set the camera to the recording mode.

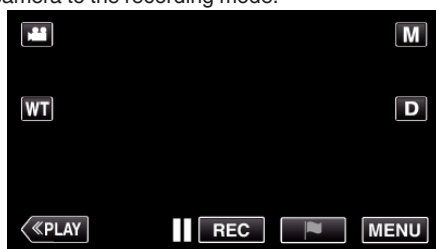

- The top menu appears.

2 Tap the "Wi-Fi" (📶) icon.

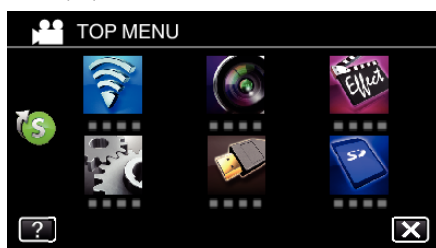

3 Tap "DETECT/MAIL" (📧).

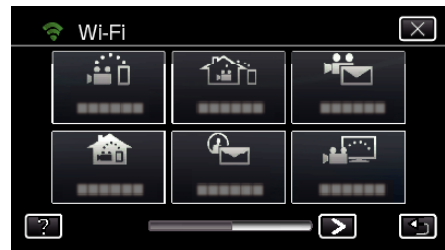

4 Tap "DETECT/MAIL ATTN.".

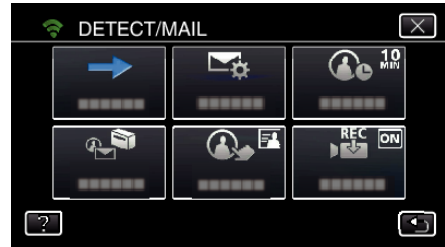

5 Select "DETECT/MAIL ATTN.", then tap ↵.

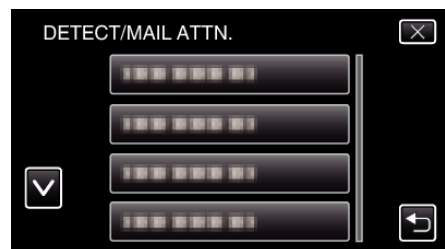

- To display the 📧 icon, tap the e-mail address.
- To cancel the e-mail address, press the icon one more time.
- Up to 8 e-mail addresses can be selected.

6 Tap "START" (➡).

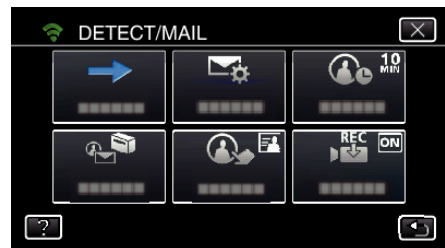

7 Start making a connection.

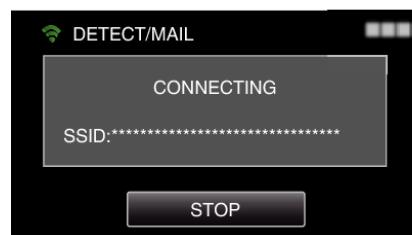

8 DETECT/MAIL detection standby



- Detection is suspended for the first 5 seconds.

9 DETECT/MAIL detection in progress (an e-mail is automatically sent out after detection is completed)



- The “PHOTO” icon appears on the screen for about 2 seconds upon detection.
- Images are captured automatically when moving subjects or human faces appear on the camera’s screen. (The PHOTO icon appears on the screen upon detection.)
- The captured still images will be sent via e-mail to the selected recipients.

10 Detection suspended

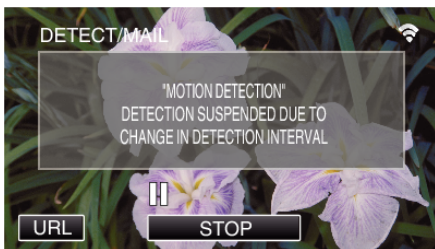

- Until the next detection is made, detection is suspended for the pre-set length of time.
 - “DETECTION INTERVAL” can be selected from 15 seconds, 1 minute, 3 minutes, 10 minutes, 30 minutes and 60 minutes.
- “Setting the Detection Interval of this Camera (DETECT/MAIL SETTING)” (☞ p. 144)

Caution :

- This function is not designed for disaster or crime prevention.
- To prevent the situation of forgetting to turn off the power, this unit will turn off automatically after 10 days of continuous usage.
- While on standby for notification mails, the focus is fixed. Perform the camera settings first, then enable notification mails. Focus may not be set correctly if the notification mails start before camera settings are made. In this case, disable notification mails temporarily, then enable it again.
- Be careful not to cause too much sending of e-mails. Depending on the internet provider that provides the e-mail service, the e-mails may be marked as spam or the usage limited may be exceeded. Be sure to check the terms of the internet provider in advance to find out if there are any restrictions on the number or size of e-mails that can be sent.
- When setting another person as the recipient, be sure to obtain his/her consent in advance.
- If you reply to the received e-mail by using this unit, the receiver can not check your replied e-mail by using this unit. Check the e-mails sent by this unit from computer, etc.
- JVC will not be responsible for any trouble that occurs upon the sending of mails.

Record and Send Videos via E-mail (VIDEO MAIL)

Videos of up to 15 seconds can be recorded and sent via e-mail. With this function, short videos can be delivered easily even on a daily basis, such as to show the growing up of small children to their distant grandparents.



Memo :

- Specifications of the videos sent via video mail are as follows:

Item	Details
System	MP4
Video	- H.264/MPEG-4 AVC baseline profile codec - 640 x 360 resolution - 25p frame rate - 1 Mbps bit rate
Audio	- Advanced Audio Coding (AAC) system - 48 kHz sampling rate - 16 bit - 2 channels

What You Need

- Wireless LAN router (use a product that has a Wi-Fi certification logo)
- Internet connection
- Account for sending e-mails (Supports SMTP. E-mail services that is only accessible from the web cannot be used.)

Settings Required in Advance

To send e-mails, the following settings are required in advance. *The above settings are not necessary if they have already been set for other functions.

- 1 Registering an access point
“Registering the Access Points of the Camera to Connect (ACCESS POINTS)” (☞ p. 145)
- 2 Setting the account for sending e-mails
“Setting the Sender’s E-mail Address of the Camera” (☞ p. 140)
- 3 Registering the recipient’s e-mail address (up to 8 addresses)
“Registering the Recipient’s E-mail Address of the Camera” (☞ p. 142)

Operation Method

- 1 Tap “MENU”.
Set the camera to the recording mode.

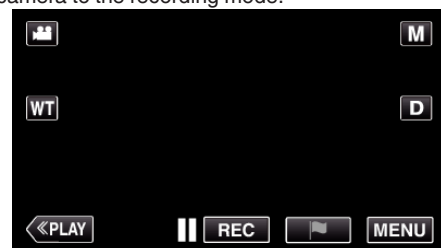

- The top menu appears.

- 2 Tap the “Wi-Fi” (Wi-Fi icon).



- 3 Tap "VIDEO MAIL" (✉).



- 4 Tap "VIDEO MAIL ADDRESS".

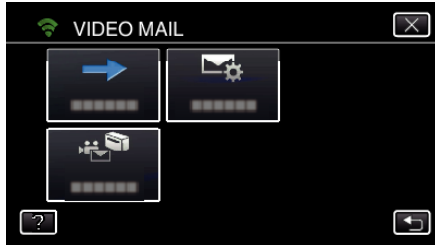

- 5 Select "VIDEO MAIL ADDRESS", then tap ↵.

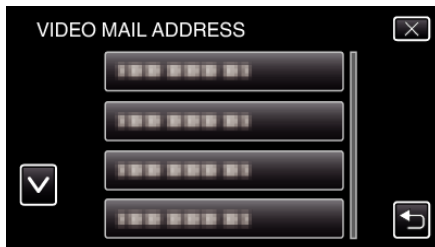

- To display the ✉ icon, tap the e-mail address.
- To cancel the e-mail address, press the icon one more time.
- Up to 8 e-mail addresses can be selected.

- 6 Tap "START" (➡).



- 7 Press the START/STOP button to start recording.

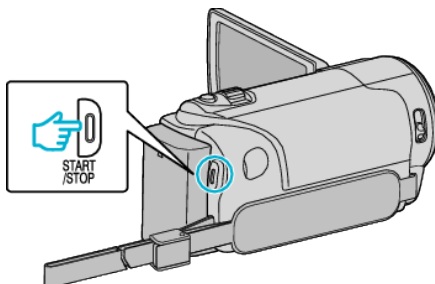

- Or, tap the REC on screen.

- 8 Recording starts after the 5-second countdown.

- Recording starts immediately after pressing the START/STOP button again during the countdown.



- You can allow the recording to be performed for 15 seconds or press the START/STOP button to stop.

- 9 Tap "SEND".

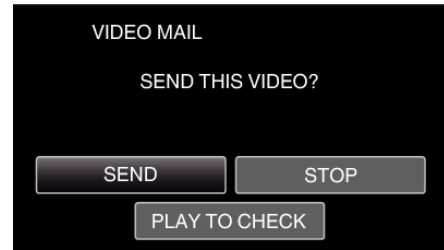

- Sending of the video mail starts.
- To check the file, tap "PLAY TO CHECK".
- When it is complete, tap "OK".

Caution :

- Be careful not to cause too much sending of e-mails. Depending on the internet provider that provides the e-mail service, the e-mails may be marked as spam or the usage limited may be exceeded. Be sure to check the terms of the internet provider in advance to find out if there are any restrictions on the number or size of e-mails that can be sent.
- When setting another person as the recipient, be sure to obtain his/her consent in advance.
- Depending on the e-mail service provider, the sending of video mail may not be supported.
- Too much usage may cause high communication fees to be incurred, and there may be a limit to the volume of communication. For more details, please check your Internet or smartphone subscription.
- If you reply to the received e-mail by using this unit, the receiver can not check your replied e-mail by using this unit. Check the e-mails sent by this unit from computer, etc.
- JVC will not be responsible for any trouble that occurs upon the sending of mails.
- Videos captured via video mail are not saved to the camera or SD card.
- Videos that have already been captured cannot be sent.

Image Monitoring on TV (TV MONITORING)

You can connect this unit to a DLNA compatible TV wirelessly to playback still images on this unit on the TV screen. (This function may not be available depending on the DLNA device in use.)

Connect via access point (wireless LAN router) at home.

What You Need

- DLNA compatible device
- Wireless LAN router (use a product that has a Wi-Fi certification logo)

Settings Required in Advance

- 1 Connect the camera to the access point (wireless LAN router).
“Registering the Access Points of the Camera to Connect (ACCESS POINTS)” (p. 145)
2. Connecting the DLNA compatible device to the access point (this function is available for a connection via cables as well)
*The above settings are not necessary if they have already been set for other functions.

Operation Method

- 1 Tap “MENU”.
(Operation on this camera)

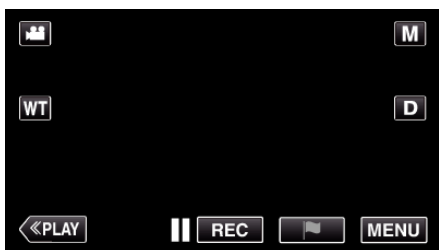

- The top menu appears.

- 2 Tap the “Wi-Fi” (Wi-Fi icon).
(Operation on this camera)

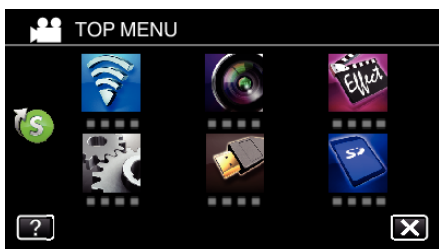

- 3 Tap “TV MONITORING” (TV icon).
(Operation on this camera)



- 4 Tap “START” (→).
(Operation on this camera)

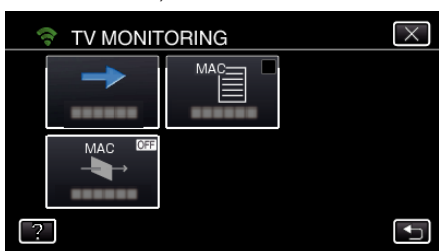

- 5 Start making a connection.

(Operation on this camera)

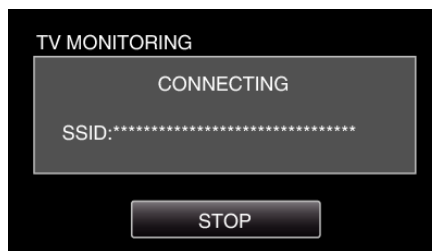

- 6 Connection in progress



- 7 After the connection is completed, wait for the DLNA device to start up.
(Operation on this camera)



- If a considerable number of videos/still images are recorded in the camera, it may take some time to start.

- 8 Operate from the DLNA device

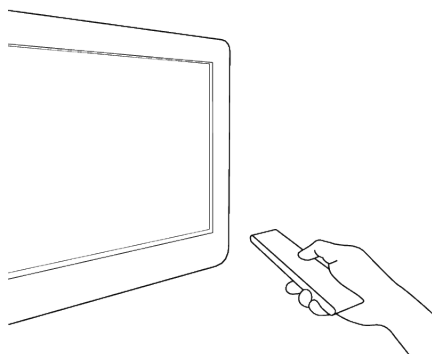

- From the DLNA device, access to the still image folder on Everio to select the images to playback.
- For operation details, refer to the instruction manual of the DLNA device in use.

- 9 Images appear on the monitor of the DLNA device
(Operation on DLNA device)



- From the following instructions, perform operations on the DLNA device.
For details on using the TV, refer to the instruction manual of the TV in use.

Memo : _____

- If the DLNA compatible TV in use cannot detect Everio, tap “STOP” to start from the step 1 again.

Caution :

- This function is not designed for disaster or crime prevention.
- We do not guarantee the compatibility of all the DLNA compatible TVs.
- This function is available when a connection to the access point is made with wires as well.
- To prevent the situation of forgetting to turn off the power, this unit will turn off automatically after 10 days of continuous usage.

EASY STORAGE

You can save the videos and still images to your computer by following easy steps.

Connect to the computer wirelessly via access point at home (wireless LAN router).

What You Need

- Computer (install LoiLoFit for Everio in your computer)
“Installing the Provided Software” (☞ p. 95)
- Wireless LAN router (use a product that has a Wi-Fi certification logo)
- Activate the UPnP function of the wireless LAN router.

Settings Required in Advance

1 Registration of the required information for connecting the camera to the access point (wireless LAN router) is necessary.

“Registering the Access Points of the Camera to Connect (ACCESS POINTS)” (☞ p. 145)

2 It is also necessary to connect the computer to the access point in advance.

*The above settings are not necessary if they have already been set for other functions.

Operation Method

- 1 Tap “MENU”.
(Operation on this camera)



- The top menu appears.

- 2 Tap the shortcut menu (☞).
(Operation on this camera)



- 3 Tap “EASY STORAGE”.
(Operation on this camera)

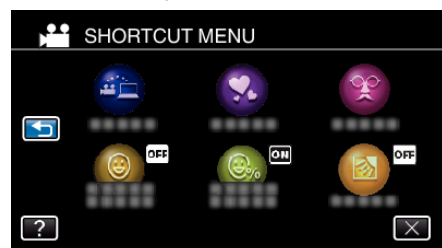

- 4 Connection starts.
(Indication on this camera)

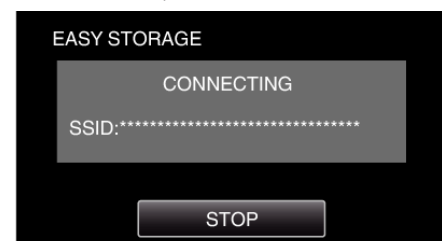

- Tap “STOP” to disconnect.

- 5 Connection is established; backup starts.
(Indication on this camera)

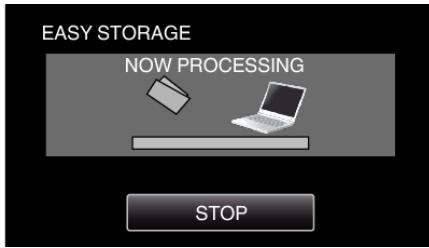

- Tap “STOP” to disconnect.

- 6 Backup starts.



- Everio Watcher appears on the task bar located on the lower right of the computer screen.
- To see the status of backing up and remaining time, move the arrow to it.

- 7 Backup is completed.
(Operation on this camera)

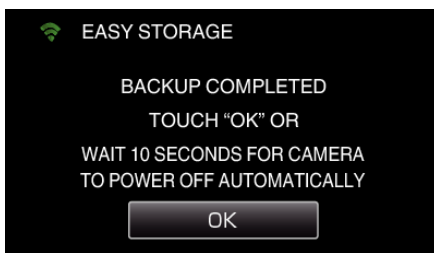

- Tap “OK”, or wait for about 10 seconds to turn off the power automatically.

Memo :

- After performing “EASY STORAGE”, it is recommended to check that the data is stored correctly.
- From the second time and onward, newly added files are backed up.

Recording the Location Information

You can record the location information of the venue where recording is taking place via direct connection (Wi-Fi Direct) with a smartphone.

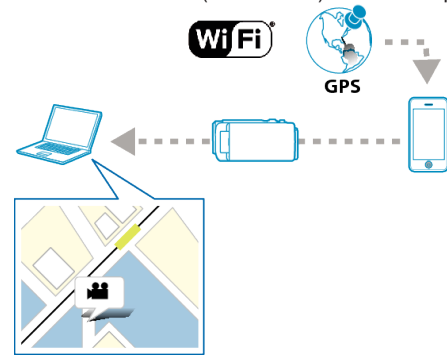

Memo :

- To obtain the location information, it is necessary to connect the smartphone to the camera and start the smartphone application. Also, setting the “LOC INFO TRANS INT” for the smartphone application is necessary.

“Smartphone Application Settings” (p. 167)

- Activate the GPS function of the smartphone in advance.
- The recorded location information can be used on the software provided with this unit.

What You Need

- Smartphone

Settings Required in Advance

Set up your camera and smartphone by performing the following operations. For a smartphone with WPS support, refer to the “Wi-Fi Protected Setup (WPS)”.

*WPS is a method to connect the camera and the smartphone wirelessly by easy button operations.

■ Connection by entering the Wi-Fi password

- 1 Tap “MENU”.
(Operation on this camera)

Set the camera to the recording mode.

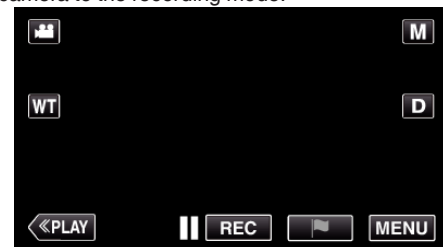

- The top menu appears.

- 2 Tap the “Wi-Fi” (Wi-Fi icon).
(Operation on this camera)

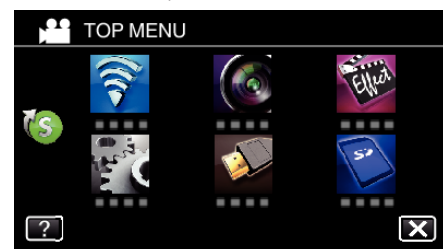

- 3 Tap the “DIRECT MONITORING” (DIRECT MONITORING icon) icon in the “Wi-Fi” menu.
(Operation on this camera)

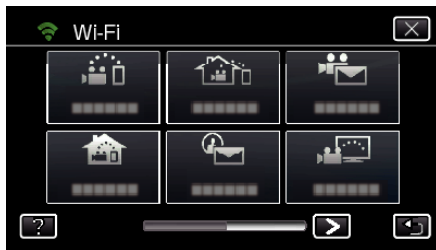

- 4 Tap "START" (→).
(Operation on this camera)

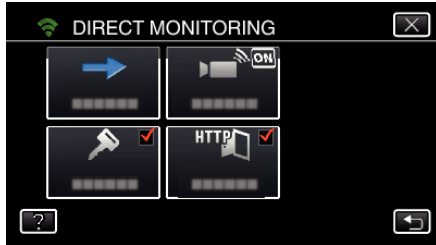

- When iFrame is selected for "VIDEO REC FORMAT", the following display appears and recording mode is switched to the 50i mode in AVCHD.

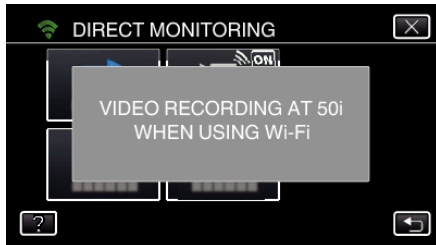

- 5 Check the SSID and the PASS being displayed on the screen of the camera.



- 6 Select the SSID in step 5 from the Wi-Fi network selection screen of your smartphone, and enter the PASS on the password screen.
(Operation on the smartphone (or computer))



- For details on connecting your smartphone (or computer) to a Wi-Fi network, please refer to the instruction manual of the phone terminal in use.

- 7 A connection is established and appears on the camera's screen.



■ Connection by Wi-Fi Protected Setup (WPS)

- 1 Tap "MENU".
(Operation on this camera)
Set the camera to the recording mode.

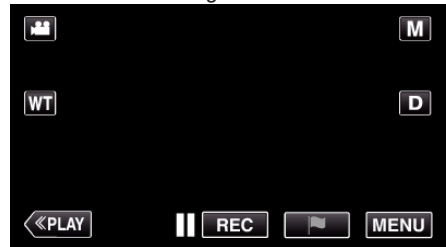

- The top menu appears.

- 2 Tap the "Wi-Fi" (📶) icon.
(Operation on this camera)

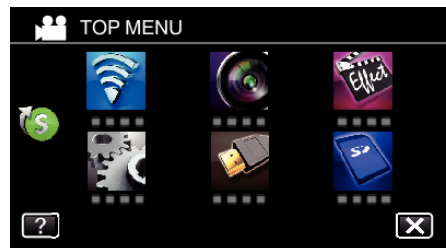

- 3 Tap the "DIRECT MONITORING" (📹) icon in the "Wi-Fi" menu.
(Operation on this camera)



- 4 Tap "START" (→).
(Operation on this camera)

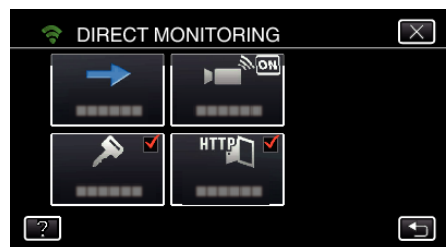

- When iFrame is selected for "VIDEO REC FORMAT", the following display appears and recording mode is switched to the 50i mode in AVCHD.

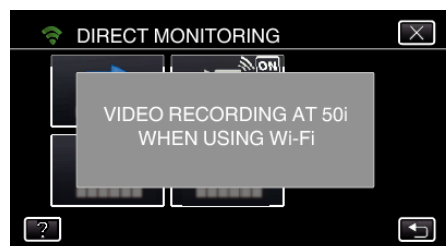

- 5 Tap "WPS".
(Operation on this camera)



- 6 Activate WPS on the smartphone (or computer) within 2 minutes.
(Operation on the smartphone (or computer))
 - To activate WPS, refer to the instruction manual of the device in use.
- 7 A connection is established and appears on the camera's screen.



Operation Method

- 1 Activate the GPS function of the smartphone.
(Operation on the smartphone)



- For details on using the smartphone, refer to the instruction manual of the device in use.

- 2 Start "Everio sync. 2" on the smartphone.



- 3 Tap "DIRECT MONITORING".



- 4 Monitor screen is displayed.

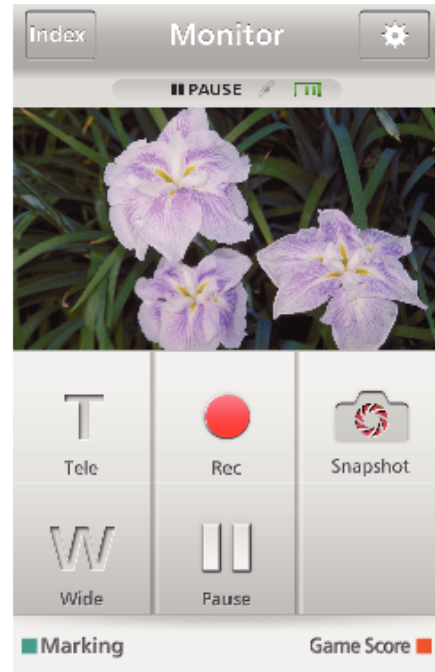

- To change the time interval for obtaining the GPS location information (OFF-15 sec.), tap .
"Smartphone Application Settings" (p. 167)

- 5 Receiving the location information
(Display on this camera)



- When the GPS location information is received from the smartphone, an icon is displayed on the camera screen.
- 6 Start recording.
(Operation on this camera)

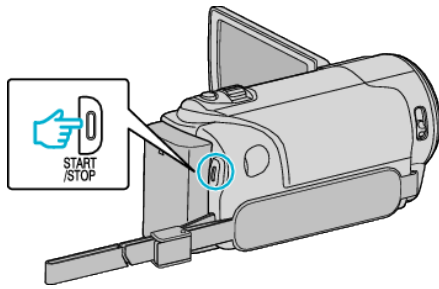

- Press the “START/STOP” button to start a normal recording.

Memo :

- Manual recording cannot be performed.
- It is not possible to switch to the playback mode.

Using the Pan Cradle (Sold Separately)

Panning operation (moving the camera to the left/right, horizontal direction) can be controlled via smartphone by setting the camera on the pan cradle. To use a pan cradle, change the setting of “AV TERMINAL” in advance. Change the setting from the menu screen of the camera.

■ Changing the setting of the AV terminal.

- By default, the AV terminal is set to “AV”. To use a pan cradle, change the setting as described in the following steps.

- 1 Tap “MENU”.
(Operation on this camera)



- 2 Tap “CONNECTION SETTINGS”.

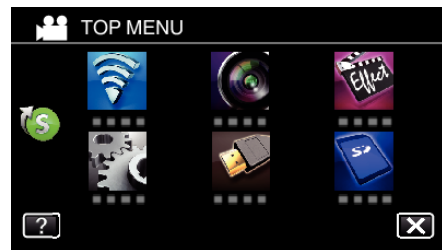

- 3 Tap “AV TERMINAL”.

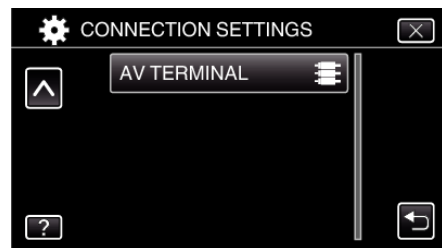

- 4 Tap “PAN CRADLE”.



- Tap X to exit the setting screen.

■ **Setting the camera to the pan cradle.**

- For how to connect the pan cradle and the camera, refer to the instruction manual of the pan cradle for further details.

1 Set the camera to the pan cradle.

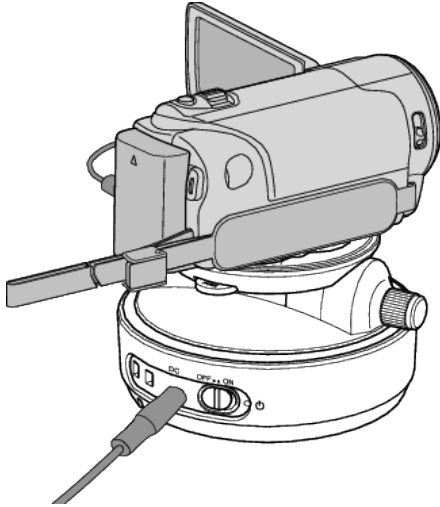

- For how to connect the pan cradle and the camera, refer to the instruction manual of the pan cradle for further details.

2 Set the power of the pan cradle to "ON".

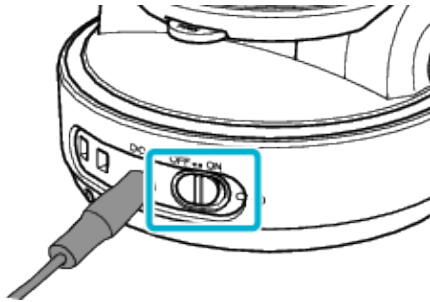

3 Wait until the pan cradle stops the rotation.

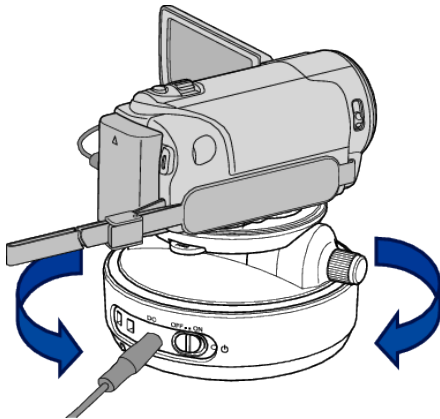

- When the power is turned ON, pan cradle moves to the left/right to adjust the position.

■ **Operations from the smartphone application**

- Connect the camera and the smartphone via DIRECT MONITORING or INDOOR MONITORING/OUTDOOR MONITORING.

"Image Monitoring via Direct Connection (DIRECT MONITORING)" (p. 112)
 "Image Monitoring via an Access Point at Home (INDOOR MONITORING)" (p. 115)
 "Image Monitoring via the Internet (OUTDOOR MONITORING)" (p. 120)

1 Start "Everio sync. 2".



- Start the application after confirming that the smartphone is connected to this camera.

2 Tap the connection method.

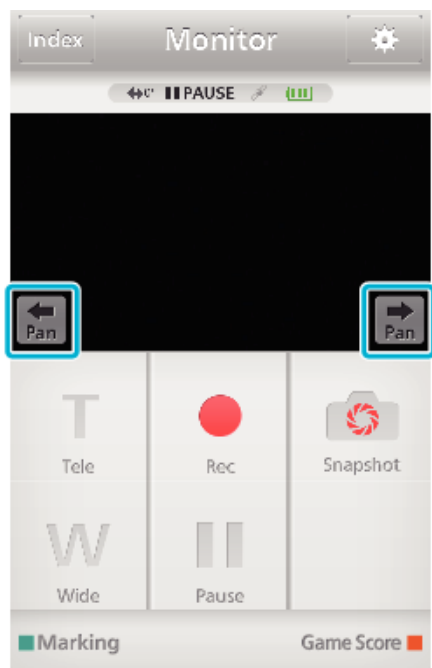

3 Tap ← / → to perform the panning operation.

**Memo :**

- Speed of the panning operation can be set in two steps.
“Changing the Panning Speed” (☞ p. 155)

Changing the Settings

To use the Wi-Fi function, it may be necessary to perform some settings on the camera and smartphone (or computer).

- Registering the access points to connect (wireless LAN router)
“Registering the Access Points of the Camera to Connect (ACCESS POINTS)” (☞ p. 145)
- Obtaining a dynamic DNS account
“Obtaining a Dynamic DNS (DDNS) Account” (☞ p. 138)
- Setting the account on this camera
“Setting Dynamic DNS on this Camera (OUTDOOR MONITORING)” (☞ p. 139)
- Setting the sender’s e-mail address
“Setting the Sender’s E-mail Address of the Camera” (☞ p. 140)
- Registering the recipient’s e-mail address
“Registering the Recipient’s E-mail Address of the Camera” (☞ p. 142)

Menu Settings

Setting	Details
DIRECT MONITORING	<p>Configures various settings related to DIRECT MONITORING.</p> <ul style="list-style-type: none"> • PASSWORD Sets the password to access the camera. “Setting the Password (DIRECT MONITORING/INDOOR MONITORING/OUTDOOR MONITORING)” (☞ p. 136) • ENFORCED GROUP OWNER (Default: “ON”) Set whether or not to get the owner group permissions. <ul style="list-style-type: none"> • OFF: Set this if connection to devices that support Wi-Fi Direct fails. (When set to OFF, connection to devices that do not support Wi-Fi Direct will be disabled.) • ON: It is recommended to set this usually. <p>“Setting the Enforced Group Owner (DIRECT MONITORING)” (☞ p. 137)</p> <ul style="list-style-type: none"> • HTTP PORT (Default: “80”) Changes the port number to access to the camera. “Changing the HTTP Port (DIRECT MONITORING/INDOOR MONITORING/OUTDOOR MONITORING)” (☞ p. 137)
INDOOR MONITORING	<p>Configures various settings related to INDOOR MONITORING.</p> <ul style="list-style-type: none"> • PASSWORD (Default: “0000”) Selects the password to access the camera. “Setting the Password (DIRECT MONITORING/INDOOR MONITORING/OUTDOOR MONITORING)” (☞ p. 136) • HTTP PORT (Default: “80”) Changes the port number to access to the camera. “Changing the HTTP Port (DIRECT MONITORING/INDOOR MONITORING/OUTDOOR MONITORING)” (☞ p. 137)
OUTDOOR MONITORING	<p>Configures various settings related to OUTDOOR MONITORING.</p> <ul style="list-style-type: none"> • PASSWORD (Default: “0000”) Selects the password to access the camera. “Setting the Password (DIRECT MONITORING/INDOOR MONITORING/OUTDOOR MONITORING)” (☞ p. 136) • UPnP (Default: “ON”) Sets the UPnP of the camera. <ul style="list-style-type: none"> • OFF: Disables UPnP. • ON: Enables UPnP. <p>“Setting the UPnP of this Camera (OUTDOOR MONITORING)” (☞ p. 138)</p> <ul style="list-style-type: none"> • DDNS SETTING Configures various settings related to DDNS. “Setting Dynamic DNS on this Camera (OUTDOOR MONITORING)” (☞ p. 139) • HTTP PORT (Default: “80”) Changes the port number to access to the camera. “Changing the HTTP Port (DIRECT MONITORING/INDOOR MONITORING/OUTDOOR MONITORING)” (☞ p. 137)
DETECT/MAIL	<p>Configures various settings related to notification mails.</p> <ul style="list-style-type: none"> • DETECT/ MAIL ATTN. Selects the recipient’s e-mail address for Detect/Mail. “Sending Still Images via E-mail upon Detection of Face or Movement (DETECT/MAIL)” (☞ p. 123) • MAIL SETTING Sets the e-mail addresses of the sender and recipient. “Setting the Sender’s E-mail Address of the Camera” (☞ p. 140) “Registering the Recipient’s E-mail Address of the Camera” (☞ p. 142) • DETECTION METHOD (Default: “MOTION DETECTION”) Sets the detection method to start recording. <ul style="list-style-type: none"> • MOTION DETECTION: Starts recording upon detection of subject’s movements. • FACE DETECTION: Starts recording upon detection of human faces. <p>“Setting the Detection Method of this Camera (DETECT/MAIL SETTING)” (☞ p. 144)</p> <ul style="list-style-type: none"> • DETECTION INTERVAL (Default: “10 minutes”) Sets the time period to enable detection again after the previous one. “Setting the Detection Interval of this Camera (DETECT/MAIL SETTING)” (☞ p. 144) • SELF RECORDING (Default: “ON”) Sets whether to record videos on this camera during detection. <ul style="list-style-type: none"> • OFF: Does not record videos on this camera. • ON: Records videos on this camera. <p>“Setting Self Recording on this Camera (DETECT/MAIL SETTING)” (☞ p. 145)</p>

Setting	Details
VIDEO MAIL	<ul style="list-style-type: none"> • VIDEO MAIL ADDRESS Selects the recipient's e-mail address for video mails. "Sending Still Images via E-mail upon Detection of Face or Movement (DETECT/MAIL)" (☞ p. 123) • MAIL SETTING Sets the e-mail addresses of the sender and recipient. "Setting the Sender's E-mail Address of the Camera" (☞ p. 140) "Registering the Recipient's E-mail Address of the Camera" (☞ p. 142)
TV MONITORING	<ul style="list-style-type: none"> • MAC ADDRESS FILTER (Default: "OFF") By setting to "ON", Everio can be searched from the device (TV monitor); the MAC address of the device needs to be registered to Everio in advance. · OFF: Disables UPnP. · ON: Enables UPnP. "Enabling the MAC Address Filter (TV MONITORING)" (☞ p. 152) • MAC ADDRESS LIST MAC address of the TV monitor can be registered to the camera. "Registering the MAC Address (TV MONITORING)" (☞ p. 152)
COMMON Wi-Fi SETTING	<p>Configures various settings related to the network.</p> <ul style="list-style-type: none"> • ACCESS POINTS Adds, deletes, or perform LAN settings of access points (wireless LAN router). "Registering the Access Points of the Camera to Connect (ACCESS POINTS)" (☞ p. 145) • MAIL SETTING Sets the e-mail addresses of the sender and recipient. "Setting the Sender's E-mail Address of the Camera" (☞ p. 140) "Registering the Recipient's E-mail Address of the Camera" (☞ p. 142) • MAC ADDRESS (Media Access Control address) Displays the MAC address of the camera. (The above shows the MAC address when connected to an access point, while the below shows the address during direct connection.) "Checking the MAC Address of this Camera" (☞ p. 153) • SET FROM QR CODE Perform the Wi-Fi setting after the camera reads the QR code generated by following the instruction in Detailed User Guide. "Using Wi-Fi by Creating a QR Code (GZ-EX315)" (☞ p. 178) • LOCK SETTINGS Sets a password to prevent others from seeing the network settings. "Protecting the Network Settings with a Password" (☞ p. 153) • INITIALIZATION Returns the network settings to their default values. "Initializing the Wi-Fi Settings" (☞ p. 154)

Setting the Password (DIRECT MONITORING/INDOOR MONITORING/OUTDOOR MONITORING)

Sets the password required to access the camera.

- Up to 8 characters (alphabets, numbers and symbols only), case-sensitive.

- 1 Tap "MENU".
(Operation on this camera)



- The top menu appears.

- 2 Tap the "Wi-Fi" (Wi-Fi icon).
(Operation on this camera)

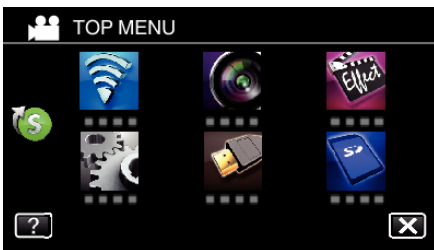

- 3 Tap "DIRECT MONITORING" (DIRECT MONITORING icon), "INDOOR MONITORING" (INDOOR MONITORING icon) or "OUTDOOR MONITORING" (OUTDOOR MONITORING icon).
(Operation on this camera)

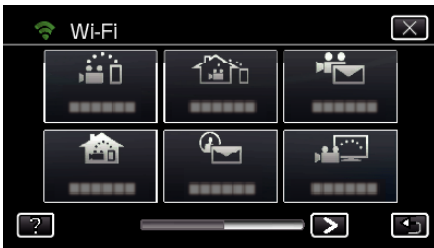

- 4 Tap "PASSWORD".
(Operation on this camera)

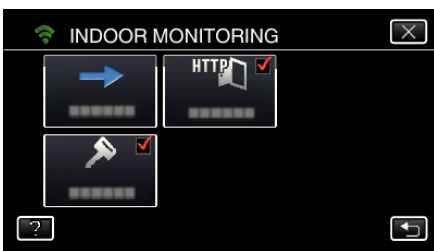

- 5 Register a password.
(Operation on this camera)



- By default, the password is set to "0000". (INDOOR MONITORING/OUTDOOR MONITORING)
- Tap on the on-screen keyboard to enter characters. The character changes with every tap. "ABC", for example, enter "A" by tapping once, "B" by tapping twice, or "C" by tapping 3 times.

- Tap "DELETE" to delete a character.
 - Tap "CANCEL" to exit.
 - Tap "A/a/1" to select character input type from upper case letter, lower case letter, and number.
 - Tap ← or → to move one space to the left or right.
- 6 Tap "SET".
(Operation on this camera)
 - Settings will not be saved until "SET" is tapped.

Setting the Enforced Group Owner (DIRECT MONITORING)

Sets whether to enforce authorization of the group owner.

- 1 Tap "MENU".
(Operation on this camera)



- The top menu appears.

- 2 Tap the "Wi-Fi" (📶) icon.
(Operation on this camera)

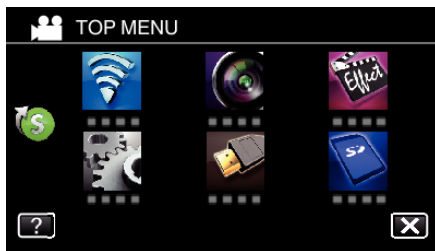

- 3 Tap the "DIRECT MONITORING" (🏠) icon in the "Wi-Fi" menu.
(Operation on this camera)



- 4 Tap "ENFORCED GROUP OWNER".
(Operation on this camera)



- 5 Tap "ON" or "OFF".

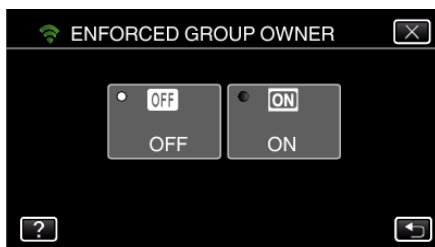

- It is recommended to select "ON" usually.
If connection to devices that support Wi-Fi Direct fails, set to "OFF".

Memo :

- When set to "OFF", connection to devices that do not support Wi-Fi Direct will be disabled.

Changing the HTTP Port (DIRECT MONITORING/INDOOR MONITORING/OUTDOOR MONITORING)

Changes the port number to access to the camera.
Valid when setting up multiple cameras for Outdoor Monitoring.

- 1 Tap "MENU".
(Operation on this camera)

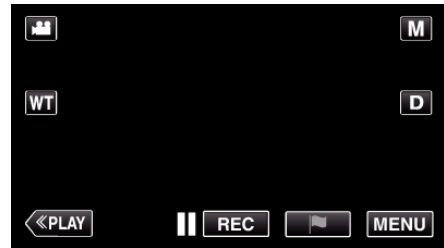

- The top menu appears.

- 2 Tap the "Wi-Fi" (📶) icon.
(Operation on this camera)

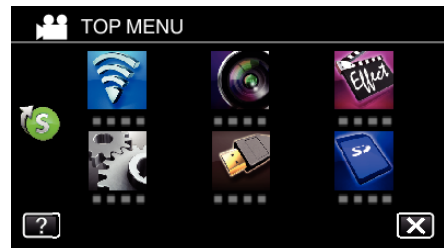

- 3 Tap "DIRECT MONITORING" (🏠), "INDOOR MONITORING" (🏠) or "OUTDOOR MONITORING" (🏠).
(Operation on this camera)



- 4 Tap "HTTP PORT".
(Operation on this camera)



- 5 Enter a port number.
(Operation on this camera)

Setting the UPnP of this Camera (OUTDOOR MONITORING)

Sets the UPnP of the camera.

- 1 Tap "MENU".
(Operation on this camera)

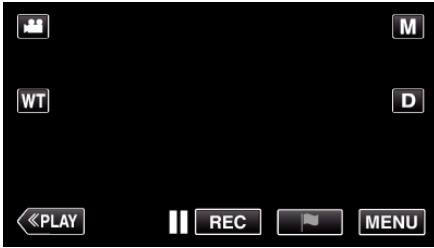

- The top menu appears.

- 2 Tap the "Wi-Fi" (Wi-Fi icon).
(Operation on this camera)

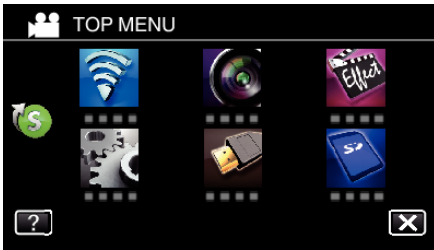

- 3 Tap "OUTDOOR MONITORING" (house icon).
(Operation on this camera)



- 4 Tap "UPnP".
(Operation on this camera)

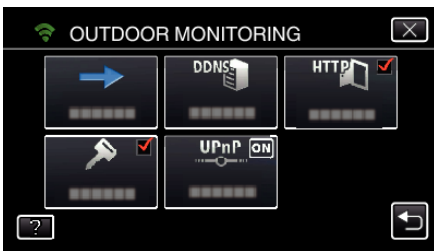

- 5 Tap "ON" or "OFF" to make a selection.

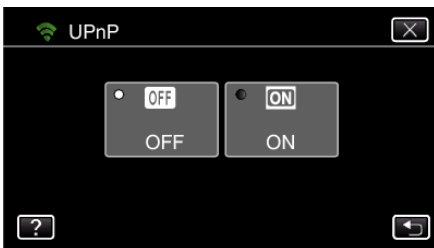

- Select "ON" to enable UPnP.
- Select "OFF" to disable UPnP.

Obtaining a Dynamic DNS (DDNS) Account

By obtaining a dynamic DNS account, this unit may be used on the web as usual even if the IP address changes when making an access to this unit via internet.

- Only the JVC dynamic DNS service can be set on this camera.
To obtain (register) an account, perform the following steps.

- 1 Access the following URL from a browser and register for an account.
(Operation on a computer or smartphone)
<https://dd3.jvckenwood.com/user/>
Set your e-mail address as the username.
- 2 Check that you have received a confirmation e-mail to the address used in registration, and access the URL stated in the e-mail.
(Operation on a computer or smartphone)
- 3 Set the username and password used in registration on the camera.
(Operation on this camera)
"Setting Dynamic DNS on this Camera (OUTDOOR MONITORING)"
(p. 139)
- 4 Execute OUTDOOR MONITORING.
(Operation on this camera)
If "OUTDOOR MONITORING" is executed while dynamic DNS settings are enabled, the camera will access the dynamic DNS server.
- 5 Tap "CAMERA NETWORK INFO." to check that the URL (WAN) is displayed.
(Registration complete)
"Image Monitoring via the Internet (OUTDOOR MONITORING)"
(p. 120)

Caution :

- Registration will be canceled if you do not access the dynamic DNS server from the camera within 3 days.
Perform the registration again in this case.
- Registration will not be complete if the username and password set on this camera are incorrect. Be sure to check that they are correct.
- Successful registration will be canceled too if you do not access the dynamic DNS server for 1 year.

Setting Dynamic DNS on this Camera (OUTDOOR MONITORING)

Sets the dynamic DNS information of the obtained account on the camera.
 “Obtaining a Dynamic DNS (DDNS) Account” (p. 138)

- 1 Tap “MENU”.
 (Operation on this camera)



- The top menu appears.

- 2 Tap the “Wi-Fi” (Wi-Fi icon).
 (Operation on this camera)

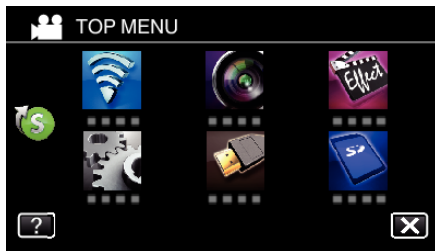

- 3 Tap “OUTDOOR MONITORING” (house icon).
 (Operation on this camera)

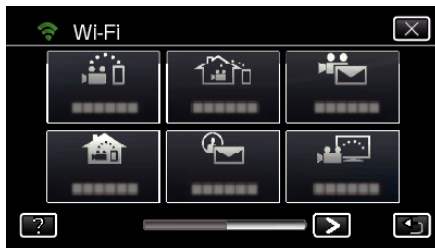

- 4 Tap “DDNS SETTING”.
 (Operation on this camera)



- 5 Tap “DDNS”, then tap “ON”.
 (Operation on this camera)

- 6 Enter the DDNS settings (username/password).
 (Operation on this camera)

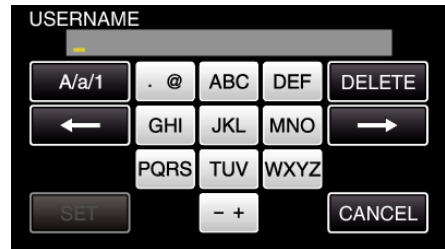

- Tap on the on-screen keyboard to enter characters. The character changes with every tap.
 “ABC”, for example, enter “A” by tapping once, “B” by tapping twice, or “C” by tapping 3 times.
- Tap “DELETE” to delete a character.
- Tap “CANCEL” to exit.
- Tap “A/a/1” to select character input type from upper case letter, lower case letter, and number.
- Tap ← or → to move one space to the left or right.
- After setting, tap “SET”.

Memo :

- Only the JVC dynamic DNS service can be set on this camera.

Setting the Sender's E-mail Address of the Camera

Sets the address to be used for sending e-mails on the camera.

Memo :

- By using Gmail as the sender's mail address, some of the settings can be omitted.
- Use of Gmail is recommended for users who have a Gmail account.

- 1 Tap "MENU".
(Operation on this camera)



- The top menu appears.

- 2 Tap the "Wi-Fi" (Wi-Fi) icon.
(Operation on this camera)

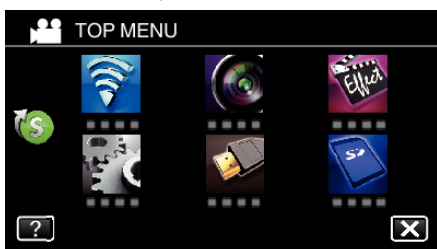

- 3 Tap > on the lower right of the screen.
(Operation on this camera)

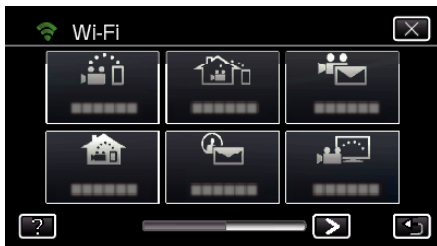

- 4 Tap "COMMON Wi-Fi SETTING".
(Operation on this camera)



- 5 Tap "MAIL SETTING".
(Operation on this camera)



- 6 Tap "SENDER'S EMAIL".
(Operation on this camera)

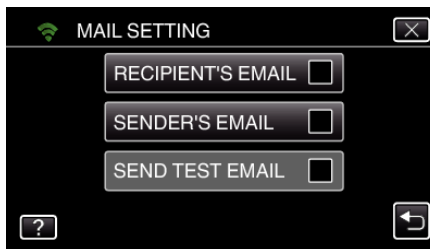

- 7 Tap "NEXT".
(Operation on this camera)

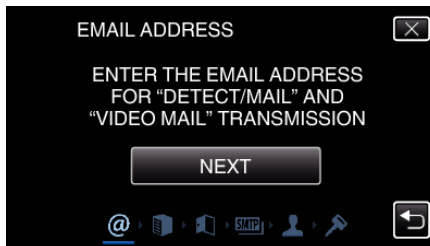

- Tap "CHANGE" to change the contents that are already set.
- Enter the e-mail address and tap "SET".

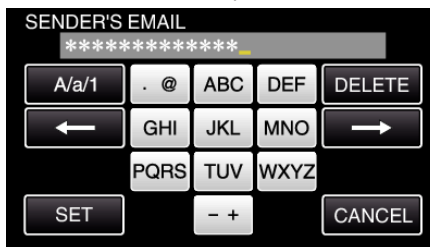

- Tap on the on-screen keyboard to enter characters. The character changes with every tap.
- Tap "DELETE" to delete a character.
- Tap "CANCEL" to exit.
- Tap "A/a/1" to select character input type from upper case letter, lower case letter, and number.
- Tap ← or → to move one space to the left or right.
- After setting, tap "SET".

- 8 Tap "NEXT".
(In case of Gmail, tap "SKIP")
(Operation on this camera)

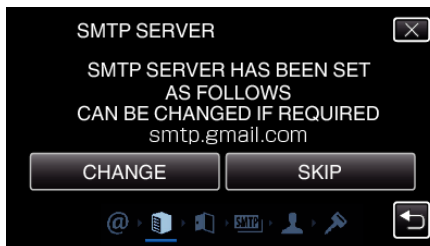

- Tap "CHANGE" to change the contents that are already set.
- Enter the SMTP server and tap "SET".

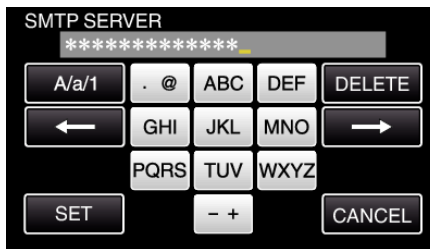

- Tap on the on-screen keyboard to enter characters. The character changes with every tap.
- Tap "DELETE" to delete a character.
- Tap "CANCEL" to exit.

- Tap “A/a/1” to select character input type from upper case letter, lower case letter, and number.
- Tap ← or → to move one space to the left or right.
- After setting, tap “SET”.

- 9 Tap “CHANGE” to change the SMTP port.
(In case of Gmail, tap “SKIP”)
(Operation on this camera)

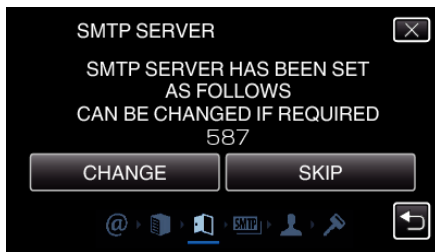

- Change the SMTP port number (if necessary) and tap “SET”.



- Tap on the on-screen keyboard to enter characters. The character changes with every tap.
- Tap “DELETE” to delete a character.
- Tap “CANCEL” to exit.
- Tap ← or → to move one space to the left or right.
- After setting, tap “SET”.

- 10 Tap “CHANGE” to change the authentication.
(In case of Gmail, tap “SKIP”)
(Operation on this camera)



- Tap the desired “AUTHENTICATE METHOD”.

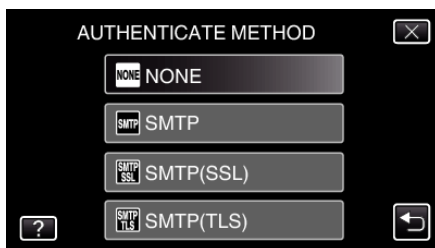

- 11 Tap “NEXT”.
(In case of Gmail, tap “SKIP”)
(Operation on this camera)

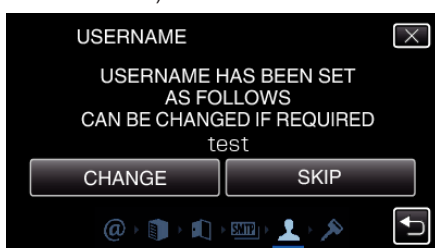

- The following does not appear if “AUTHENTICATE METHOD” is set to “NONE”.
- Tap “CHANGE” to change the contents that are already set.

- Enter the username and tap “SET”.



- Tap on the on-screen keyboard to enter characters. The character changes with every tap.
- Tap “DELETE” to delete a character.
- Tap “CANCEL” to exit.
- Tap “A/a/1” to select character input type from upper case letter, lower case letter, and number.
- Tap ← or → to move one space to the left or right.
- After setting, tap “SET”.

- 12 Tap “NEXT”.
(Operation on this camera)

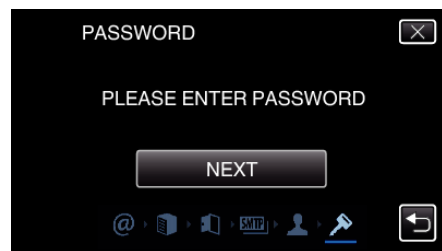

- The following does not appear if “AUTHENTICATE METHOD” is set to “NONE”.
- Tap “CHANGE” to change the contents that are already set.
- Enter the password and tap “SET”.



- Tap on the on-screen keyboard to enter characters. The character changes with every tap.
- Tap “DELETE” to delete a character.
- Tap “CANCEL” to exit.
- Tap “A/a/1” to select character input type from upper case letter, lower case letter, and number.
- Tap ← or → to move one space to the left or right.
- After setting, tap “SET”.

- 13 Tap “QUIT” or “SEND TEST EMAIL”.
(Operation on this camera)

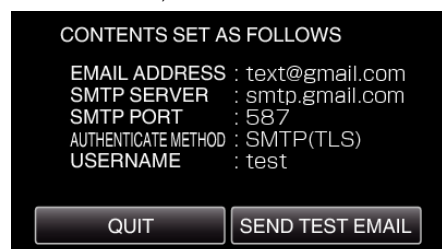

SENDER'S EMAIL	Enter the sender's e-mail address.
SMTP SERVER	Enter the SMTP server address.
SMTP PORT	Set this when the SMTP port number needs to be changed.

AUTHENTICATE METHOD	Set this when the authentication method needs to be changed.
USERNAME	Enter the username.
PASSWORD	Enter the password.

Caution :

- It is necessary to obtain an e-mail account in advance.
- Some web-based mail addresses do not support this feature.
- These are Gmail settings as of December 2012.
Perform setting manually if changes have been made to the Gmail specifications.
- To make use of addresses other than Gmail, please consult the mail service provider (Internet provider, etc.) for information on the settings.

Registering the Recipient's E-mail Address of the Camera

Registers the e-mail addresses of recipients on the camera.

- 1 Tap "MENU".
(Operation on this camera)



- The top menu appears.

- 2 Tap the "Wi-Fi" icon.
(Operation on this camera)

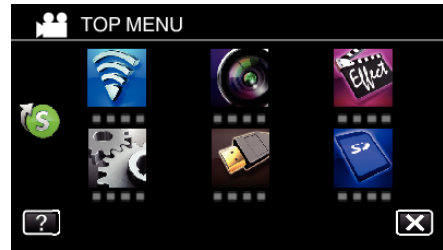

- 3 Tap > on the lower right of the screen.
(Operation on this camera)



- 4 Tap "COMMON Wi-Fi SETTING".
(Operation on this camera)



- 5 Tap "MAIL SETTING".
(Operation on this camera)

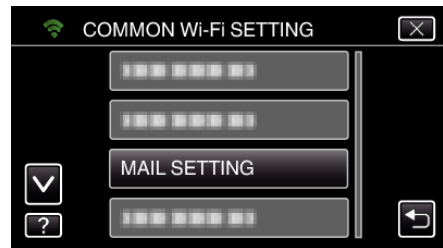

- 6 Tap "RECIPIENT'S EMAIL".
(Operation on this camera)

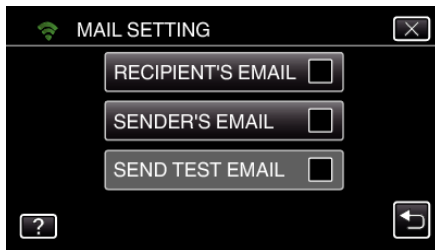

- 7 Tap "ADD".
(Operation on this camera)

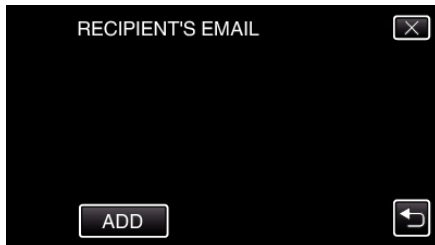

- 8 Enter the recipient's e-mail address.

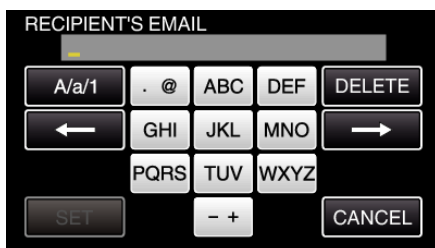

- Tap on the on-screen keyboard to enter characters. The character changes with every tap. "ABC", for example, enter "A" by tapping once, "B" by tapping twice, or "C" by tapping 3 times.
 - Tap "DELETE" to delete a character.
 - Tap "CANCEL" to exit.
 - Tap "A/a/1" to select character input type from upper case letter, lower case letter, and number.
 - Tap ← or → to move one space to the left or right.
 - After setting, tap "SET".
- 9 After tapping "DETECT/MAIL" or "VIDEO MAIL" depending on the function in use, tap "SET".

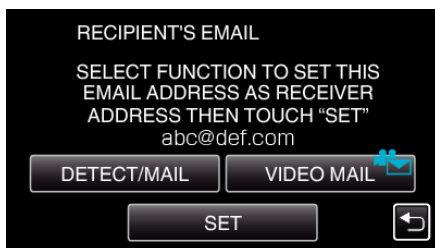

- An icon (📧) appears after tapping "DETECT/MAIL", and the recipient's e-mail address for the Detect/Mail.
- An icon (📹) appears after tapping "VIDEO MAIL", and the recipient's e-mail address for the VIDEO MAIL.
- To cancel, press the icon one more time.

Memo : _____

- Up to 8 e-mail addresses can be registered as recipients.

Caution : _____

- When setting another person as the recipient, be sure to obtain his/her consent in advance.
- Check whether notifications indicating errors have been sent to the sender's e-mail address. (Make use of a computer or similar devices as it is not possible to check from the camera.)

If no notifications are received: Refer to "Unable to send e-mails." and adjust the settings accordingly.

If notifications are received: Check the content of the notification.

***Note**

Do not continue sending e-mails with the same settings if you receive error notifications. Depending on the provider, you may be marked as a sender of spam (junk mail).

Setting the Detection Method of this Camera (DETECT/MAIL SETTING)

Sets the detection method to start recording.

- 1 Tap "MENU".
(Operation on this camera)



- The top menu appears.

- 2 Tap the "Wi-Fi" (Wi-Fi icon).
(Operation on this camera)

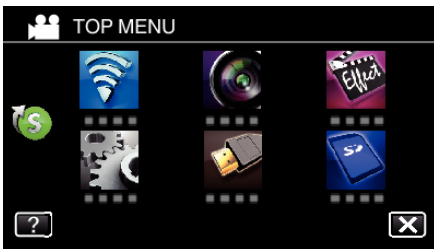

- 3 Tap "DETECT/MAIL" (DETECT/MAIL icon).
(Operation on this camera)



- 4 Tap "DETECTION METHOD".
(Operation on this camera)

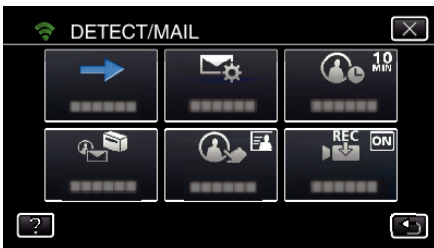

- 5 Tap "MOTION DETECTION" or "FACE DETECTION" to make a selection.

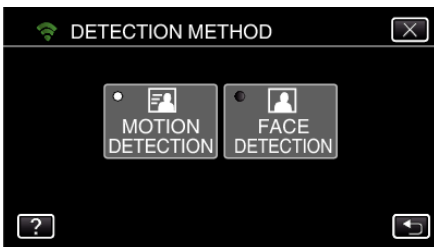

- Select "MOTION DETECTION" to start recording upon detection of subject's movements.
- Select "FACE DETECTION" to start recording upon detection of human faces.

Setting the Detection Interval of this Camera (DETECT/MAIL SETTING)

Sets the time period to enable detection again after the previous one.

- 1 Tap "MENU".
(Operation on this camera)



- The top menu appears.

- 2 Tap the "Wi-Fi" (Wi-Fi icon).
(Operation on this camera)

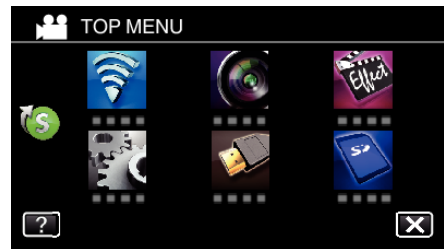

- 3 Tap "DETECT/MAIL" (DETECT/MAIL icon).
(Operation on this camera)

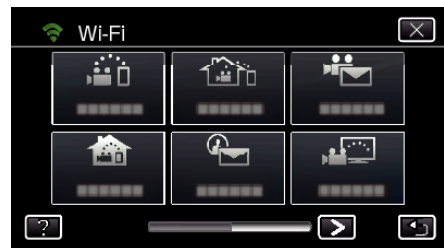

- 4 Tap "DETECTION INTERVAL".
(Operation on this camera)

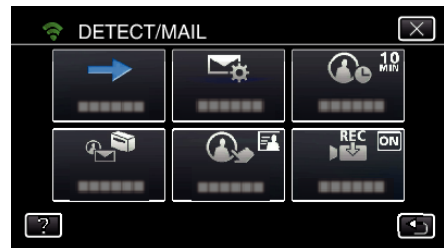

- 5 Tap the desired detection interval.

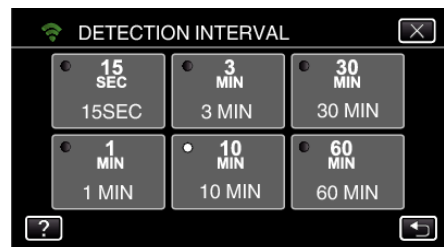

- Set the interval to perform detection. By default, it is set to 10 minutes.

Setting Self Recording on this Camera (DETECT/MAIL SETTING)

Sets whether to record videos on this camera during detection.

- 1 Tap "MENU".
(Operation on this camera)

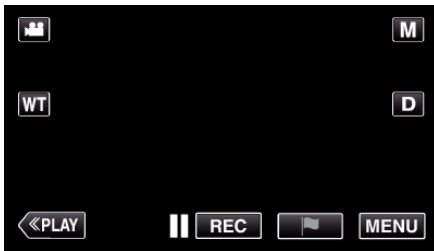

- The top menu appears.

- 2 Tap the "Wi-Fi" (Wi-Fi icon).
(Operation on this camera)

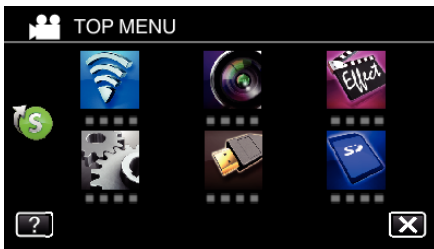

- 3 Tap "DETECT/MAIL" (DETECT/MAIL icon).
(Operation on this camera)



- 4 Tap "SELF RECORDING".
(Operation on this camera)

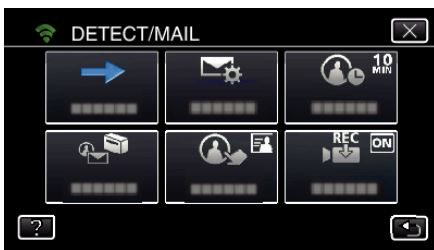

- 5 Tap "ON" or "OFF" to make a selection.

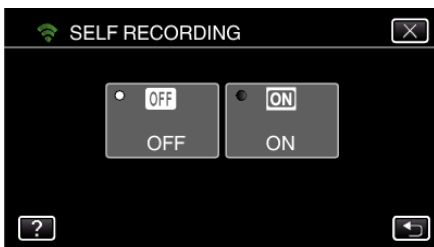

- Select "ON" to record videos on this camera.
- Select "OFF" not to record videos on this camera.

Registering the Access Points of the Camera to Connect (ACCESS POINTS)

There are 4 ways to register the access points (wireless LAN router) for connection.

Wi-Fi Protected Setup (WPS) Registration	This is the easiest way of registration. Authentication method and wireless LAN setup are performed automatically in WPS, allowing easy registration of connection settings between devices.
Search and Register	A search is conducted to locate access points. Select and register an access point from the list of search results.
Manual Registration	Enter the name and authentication method manually to register an access point.
WPS PIN Registration	Enter the WPS PIN code of the camera to the access point to register.

Memo :

- By registering multiple access points, you can change connection to another access point by tapping on the desired one from the list.

■ Wi-Fi Protected Setup (WPS) Registration

- 1 Tap "MENU".
(Operation on this camera)

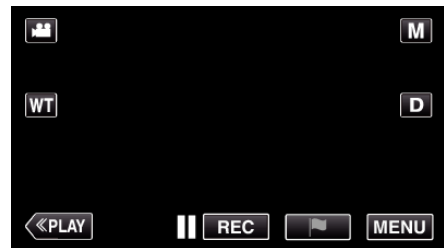

- The top menu appears.

- 2 Tap the "Wi-Fi" (Wi-Fi icon).
(Operation on this camera)

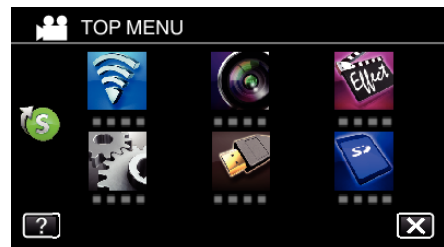

- 3 Tap > on the lower right of the screen.
(Operation on this camera)



- 4 Tap "COMMON Wi-Fi SETTING".
(Operation on this camera)

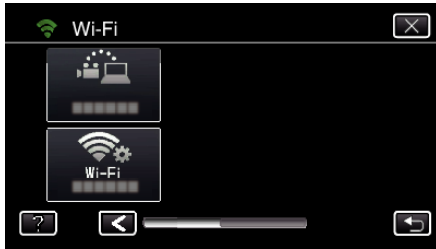

- 5 Tap "ACCESS POINTS".
(Operation on this camera)



- 6 Tap "ADD".
(Operation on this camera)



- 7 Tap "EZ REGISTRATION WPS".
(Operation on this camera)

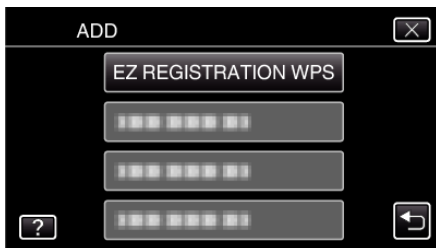

- 8 Activate WPS of the access point (wireless LAN router) within 2 minutes.
 - To activate WPS, refer to the instruction manual of the device in use.

- 9 After registration is complete, tap "OK" on the camera's screen.
(Operation on this camera)



■ Search and Register

- 1 Tap "MENU".
(Operation on this camera)



- The top menu appears.

- 2 Tap the "Wi-Fi" (Wi-Fi icon).
(Operation on this camera)

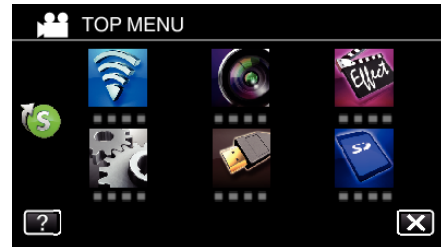

- 3 Tap > on the lower right of the screen.
(Operation on this camera)



- 4 Tap "COMMON Wi-Fi SETTING".
(Operation on this camera)



- 5 Tap "ACCESS POINTS".
(Operation on this camera)

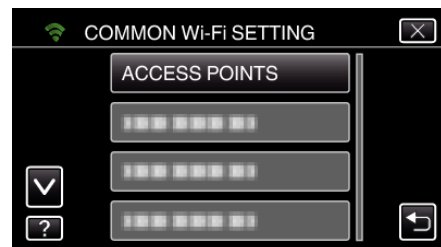

- 6 Tap "ADD".
(Operation on this camera)



- 7 Tap "SEARCH".
(Operation on this camera)

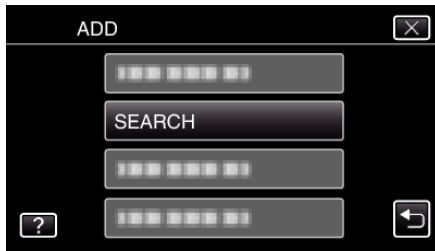

- The search results appear on the camera's screen.
- 8 Tap the name (SSID) of the desired access point from the list of search results.
(Operation on this camera)

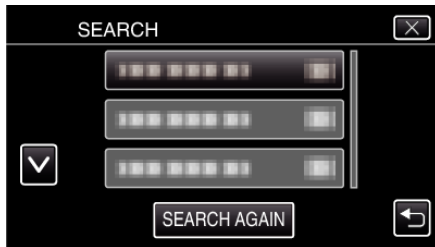

- 9 Register a password.
(Operation on this camera)



- Tap on the on-screen keyboard to enter characters. The character changes with every tap. "ABC", for example, enter "A" by tapping once, "B" by tapping twice, or "C" by tapping 3 times.
 - Tap "DELETE" to delete a character.
 - Tap "CANCEL" to exit.
 - Tap "A/a/1" to select character input type from upper case letter, lower case letter, and number.
 - Tap ← or → to move one space to the left or right.
 - The password is not required if the wireless LAN router is not security protected.
- 10 After registration is complete, tap "OK" on the camera's screen.
(Operation on this camera)



Manual Registration

- 1 Tap "MENU".
(Operation on this camera)



- The top menu appears.
- 2 Tap the "Wi-Fi" (Wi-Fi) icon.
(Operation on this camera)

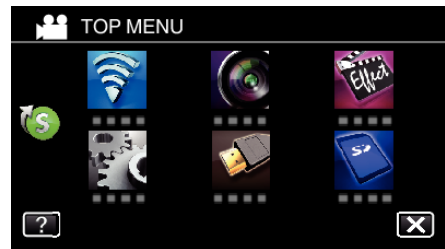

- 3 Tap > on the lower right of the screen.
(Operation on this camera)



- 4 Tap "COMMON Wi-Fi SETTING".
(Operation on this camera)



- 5 Tap "ACCESS POINTS".
(Operation on this camera)

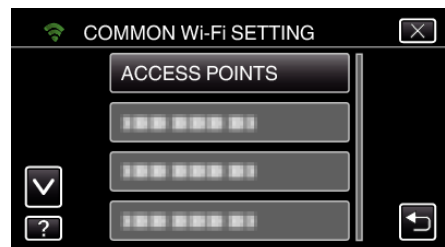

- 6 Tap "ADD".
(Operation on this camera)



- 7 Tap "MANUAL".
(Operation on this camera)

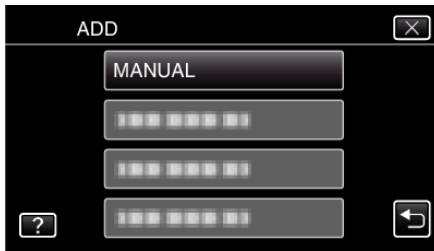

- 8 Enter the name (SSID) of the access point (wireless LAN router) and tap "SET".
(Operation on this camera)



- Tap on the on-screen keyboard to enter characters. The character changes with every tap. "ABC", for example, enter "A" by tapping once, "B" by tapping twice, or "C" by tapping 3 times.
- Tap "DELETE" to delete a character.
- Tap "CANCEL" to exit.
- Tap "A/a/1" to select character input type from upper case letter, lower case letter, and number.
- Tap ← or → to move one space to the left or right.

- 9 Select the type of authentication method (security).
(Operation on this camera)

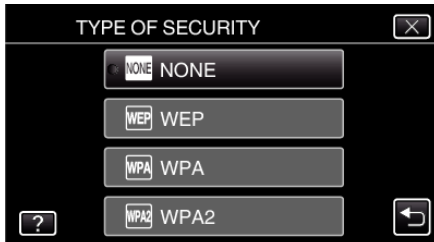

- Select according to the setting of your router.

- 10 When authentication method is not set to "NONE", enter a password and tap "SET".
(Operation on this camera)



- Tap on the on-screen keyboard to enter characters. The character changes with every tap. "ABC", for example, enter "A" by tapping once, "B" by tapping twice, or "C" by tapping 3 times.
- Tap "DELETE" to delete a character.
- Tap "CANCEL" to exit.
- Tap "A/a/1" to select character input type from upper case letter, lower case letter, and number.
- Tap ← or → to move one space to the left or right.

- 11 After registration is complete, tap "OK" on the camera's screen.
(Operation on this camera)

■ WPS PIN Registration

- 1 Tap "MENU".
(Operation on this camera)



- The top menu appears.

- 2 Tap the "Wi-Fi" (Wi-Fi) icon.
(Operation on this camera)

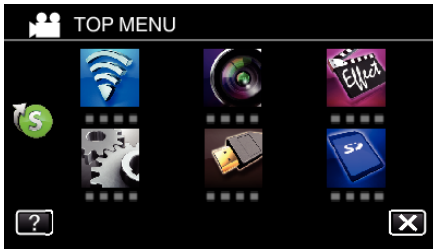

- 3 Tap > on the lower right of the screen.
(Operation on this camera)



- 4 Tap "COMMON Wi-Fi SETTING".
(Operation on this camera)



- 5 Tap "ACCESS POINTS".
(Operation on this camera)

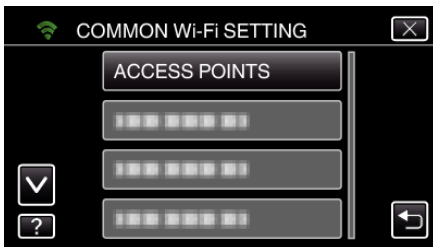

- 6 Tap "ADD".
(Operation on this camera)

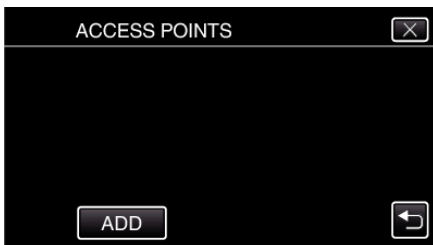

- 7 Tap "WPS PIN".
(Operation on this camera)

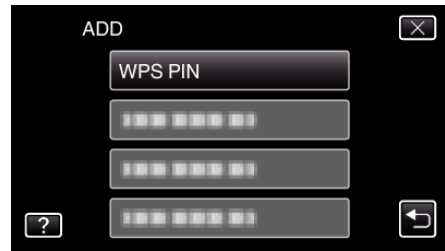

- The PIN code appears.

- 8 Enter the PIN code displayed on the camera to the access point (wireless LAN router).
 - For details on how to enter the PIN code, refer to the instruction manual of the device in use.

- 9 Tap "START".
(Operation on this camera)



- Tap "START" after entering PIN code to the wireless LAN router. (Connection cannot be established if "START" is tapped before entering the code.)

- 10 After registration is complete, tap "OK" on the camera's screen.
(Operation on this camera)



Editing LAN Settings of Access Points (Wireless LAN Router)

Change accordingly such as when you want to fix the IP address for the camera.

- 1 Tap "MENU".
(Operation on this camera)



- The top menu appears.

- 2 Tap the "Wi-Fi" (Wi-Fi icon).
(Operation on this camera)

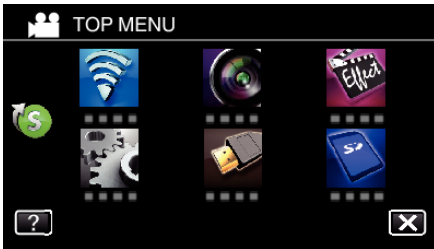

- 3 Tap > on the lower right of the screen.
(Operation on this camera)



- 4 Tap "COMMON Wi-Fi SETTING".
(Operation on this camera)



- 5 Tap "ACCESS POINTS".
(Operation on this camera)

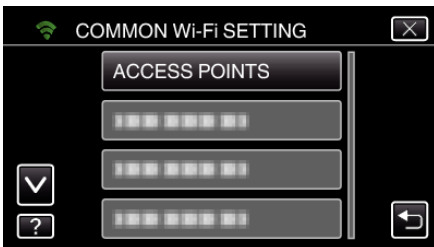

- 6 Tap "LAN SETTINGS".
(Operation on this camera)

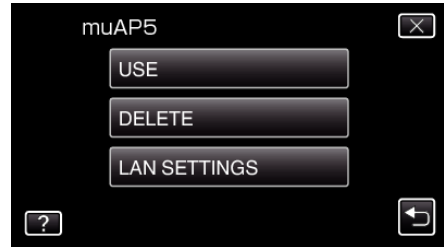

- Tap "USE" to use the selected access point.
- Tap "DELETE" to delete the registered access point.

- 7 Perform the LAN settings. (when "DHCP" is set to "OFF")
(Operation on this camera)

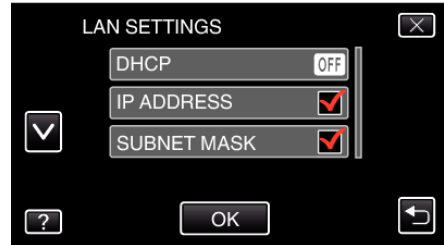

- After setting, tap "OK".
- LAN settings comprise of the following items.

DHCP	ON: Obtains IP address from the DHCP server automatically. OFF: Settings of "IP ADDRESS", "SUBNET MASK", "DEFAULT GATEWAY", "PRIMARY DNS", and "SECONDARY DNS" are required.
IP ADDRESS	Enter the IP address.
SUBNET MASK	Enter the subnet mask.
DEFAULT GATEWAY	Enter the default gateway.
PRIMARY DNS / SECONDARY DNS	Enter the IP addresses of the primary and secondary DNS servers.

Setting the Password (DIRECT MONITORING)

Sets the password for direct monitoring. (8 to 32 characters)

- 1 Tap "MENU".
(Operation on this camera)

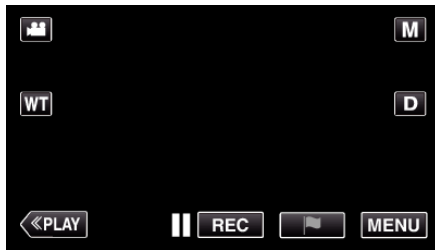

- The top menu appears.

- 2 Tap the "Wi-Fi" (Wi-Fi icon) icon.
(Operation on this camera)

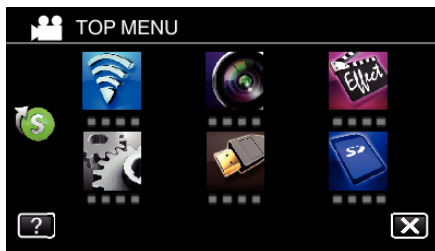

- 3 Tap the "DIRECT MONITORING" (lock icon) icon in the "Wi-Fi" menu.
(Operation on this camera)



- 4 Tap "PASSWORD".
(Operation on this camera)



- 5 Register a password.
(Operation on this camera)

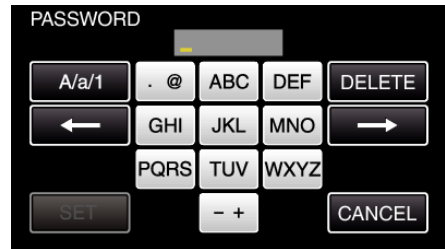

- Tap on the on-screen keyboard to enter characters. The character changes with every tap. "ABC", for example, enter "A" by tapping once, "B" by tapping twice, or "C" by tapping 3 times.
 - Tap "DELETE" to delete a character.
 - Tap "CANCEL" to exit.
 - Tap "A/a/1" to select character input type from upper case letter, lower case letter, and number.
 - Tap ← or → to move one space to the left or right.
 - After setting, tap "SET".
- 6 Tap "SET".
(Operation on this camera)
 - Settings will not be saved until "SET" is tapped.

Enabling the MAC Address Filter (TV MONITORING)

By enabling "MAC ADDRESS FILTER", Everio can be searched from the device (TV monitor); the MAC address of the device needs to be registered to Everio in advance.

- 1 Tap "MENU".
(Operation on this camera)

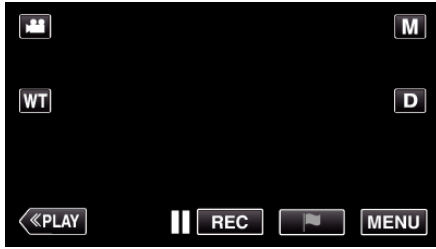

- The top menu appears.

- 2 Tap the "Wi-Fi" (Wi-Fi icon).
(Operation on this camera)

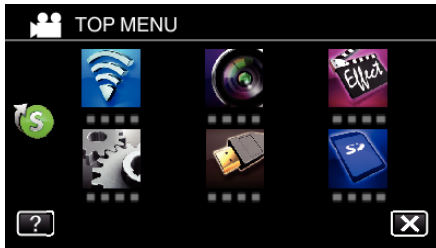

- 3 Tap "TV MONITORING".



- 4 Tap "MAC ADDRESS FILTER".

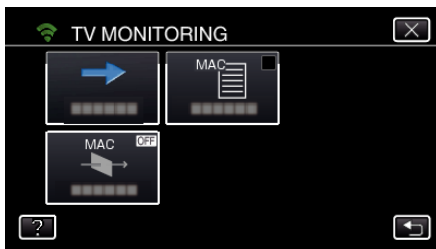

- 5 Select "ON" or "OFF".

Memo :

- If "MAC ADDRESS FILTER" is enabled while no MAC address is registered, Everio can not be searched from all the devices.

Registering the MAC Address (TV MONITORING)

Register the MAC address of the TV monitor to Everio.

- 1 Tap "MENU".
(Operation on this camera)



- The top menu appears.

- 2 Tap the "Wi-Fi" (Wi-Fi icon).
(Operation on this camera)



- 3 Tap "TV MONITORING".



- 4 Tap "MAC ADDRESS LIST".

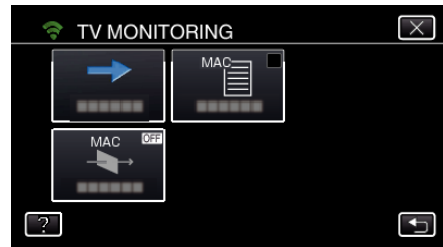

- 5 Tap "ADD".

- 6 Enter the MAC address of the TV monitor.

- Tap on the on-screen keyboard to enter characters.
- Tap "DELETE" to delete a character.
- Tap "CANCEL" to exit.
- Tap "A/a/1" to change the characters.
- Tap ← or → to move one space to the left or right.
- After setting, tap "SET".
- For details on checking the MAC address for registration, refer to the instruction manual of the device in use.

Checking the MAC Address of this Camera

Displays the MAC address of the camera.

- 1 Tap "MENU".
(Operation on this camera)



- The top menu appears.

- 2 Tap the "Wi-Fi" (Wi-Fi icon).
(Operation on this camera)

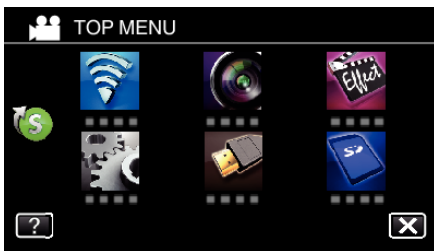

- 3 Tap > on the lower right of the screen.
(Operation on this camera)

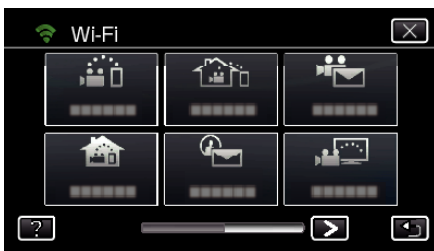

- 4 Tap "COMMON Wi-Fi SETTING".
(Operation on this camera)

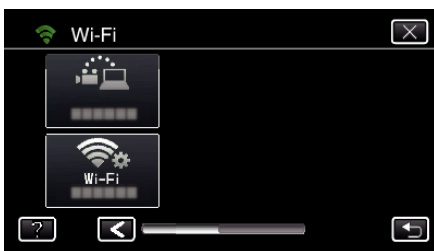

- 5 Tap "MAC ADDRESS".
(Operation on this camera)



- The MAC address of the camera appears.
(The above shows the address during direct connection, while the below shows the MAC address when connected to an access point.)
- After checking, tap "SET".

Protecting the Network Settings with a Password

Sets a password to lock and protect the network settings.

- 1 Tap "MENU".
(Operation on this camera)



- The top menu appears.

- 2 Tap the "Wi-Fi" (Wi-Fi icon).
(Operation on this camera)

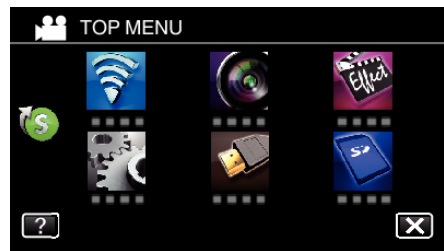

- 3 Tap > on the lower right of the screen.
(Operation on this camera)



- 4 Tap "COMMON Wi-Fi SETTING".
(Operation on this camera)



- 5 Tap "LOCK SETTINGS".
(Operation on this camera)

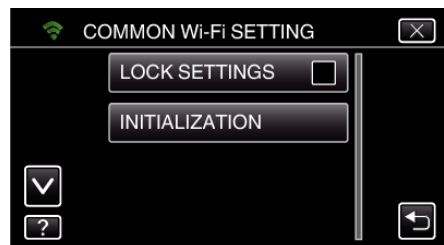

- 6 Set a password (up to 4 characters).
(Operation on this camera)

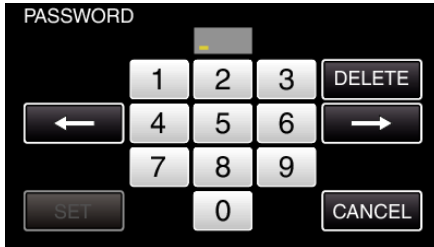

- Enter the 4-digit numbers.
- Tap “DELETE” to delete a character.
- Tap “CANCEL” to exit.
- Tap ← or → to move one space to the left or right.
- After setting, tap “SET”.

Initializing the Wi-Fi Settings

Returns the Wi-Fi settings to their default values.

- 1 Tap “MENU”.
(Operation on this camera)



- The top menu appears.

- 2 Tap the “Wi-Fi” (📶) icon.
(Operation on this camera)

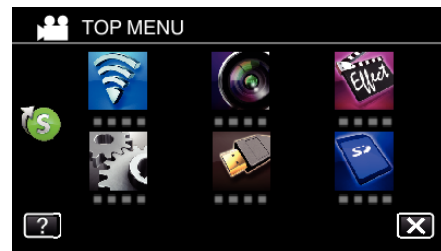

- 3 Tap > on the lower right of the screen.
(Operation on this camera)

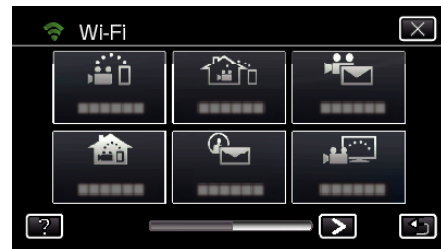

- 4 Tap “COMMON Wi-Fi SETTING”.
(Operation on this camera)



- 5 Tap “INITIALIZATION”.
(Operation on this camera)

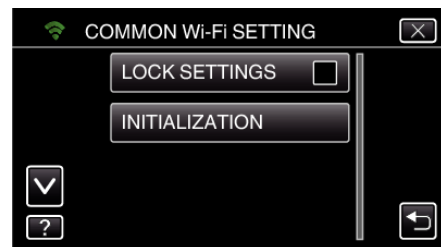

- 6 Tap “YES”.
(Operation on this camera)



- To cancel, tap “NO”.
- When “YES” is tapped, the network settings return to their default values.

Changing the Panning Speed

Change the operation speed of the pan cradle (sold separately) via smartphone.

Select either of the 2: “HIGH SPEED” or “LOW SPEED”.

- For details on how to use a pan cradle, refer to the following.

“Using the Pan Cradle (Sold Separately)” (p. 131)

■ Change the setting via smartphone

- 1 Tap .

Confirm that the camera and a smartphone are connected via Wi-Fi, and the monitor screen is displayed on the smartphone.

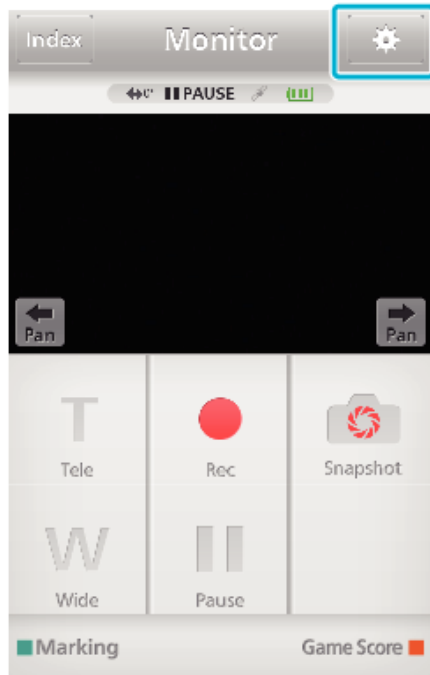

- 2 Tap “PAN OPERATION SPEED”.



- 3 Tap “HIGH SPEED” or “LOW SPEED”.



Using Smartphone Applications

- By installing the “Everio sync. 2” smartphone software, images on the camera can be checked from a distance, and recording videos/still images and zooming operation can be performed.
- You can also send images recorded by the camera to the smartphone via Wi-Fi, to enjoy the recorded images on your smartphone or tablet.

Installing Smartphone Applications



■ Android Smartphone

- 1 Tap “PLAY STORE” on the application list.
- 2 Search for the “Everio sync. 2” application.
- 3 Tap on the “Everio sync. 2” application.
 - The detailed information of the application is displayed.
- 4 Tap “INSTALL”.
 - For applications that access data or functions of this unit, a screen that shows the data or functions that will be used is displayed.
- 5 Confirm the content and tap “DOWNLOAD”.
 - Downloading starts.

Deleting the Application

- 1 Tap “PLAY STORE” on the application list.
 - 2 Press the menu button and tap “My apps”.
- A list of previously downloaded applications is displayed.
- 3 Tap on the “Everio sync. 2” application.
 - 4 Tap “Uninstall”, then tap “OK”.

Memo :

The specifications of Google Play are subject to changes without prior notice.

For operating details, refer to the help file of Google Play.

■ iPhone/iPad/iPod touch

- 1 Tap “App Store” on the home screen.
- 2 Search for the “Everio sync. 2” application.
- 3 Tap on the “Everio sync. 2” application.
 - The detailed information of the application is displayed.
- 4 Tap “FREE”→“INSTALL”.
 - Enter your password on the password entry screen.
 - Downloading starts.
 - The downloaded application will be added to the home screen automatically.

Deleting the Application

- 1 Press and hold the “Everio sync. 2” application on the home screen.
- 2 Tap X to confirm the deletion.

Memo :

The specifications of App Store™ are subject to changes without prior notice.

For operating details, refer to the help file of App Store™.

Operating the Smartphone Applications

- Indications on the screen
“Indications on the Screen” (p. 156)
- Transferring videos

“Transferring Videos (AVCHD format)” (p. 160)

“Transferring Videos (iFrame format)” (p. 163)

- Transferring still images
“Transferring Still Images” (p. 165)
- Changing the settings
“Smartphone Application Settings” (p. 167)

Indications on the Screen

■ Initial Screen

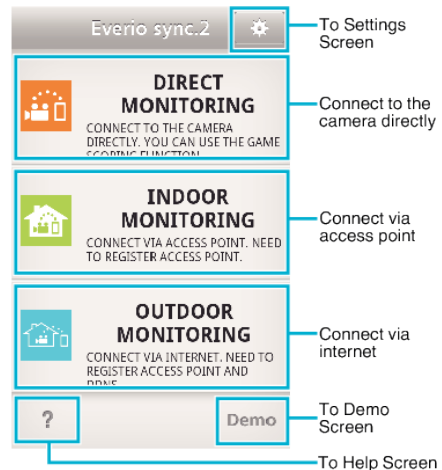

■ Recording Screen

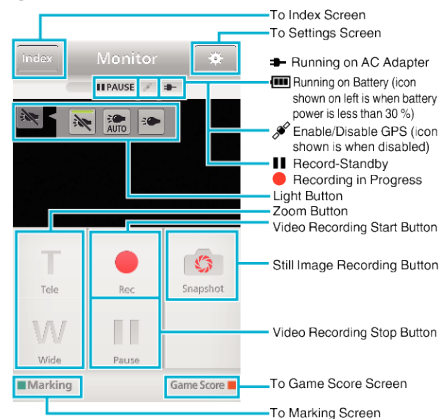

■ Index Screen (AVCHD Video/iFrame Video/Still image)

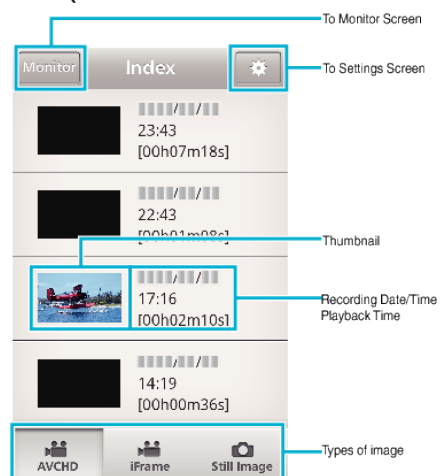

Transfer Screen

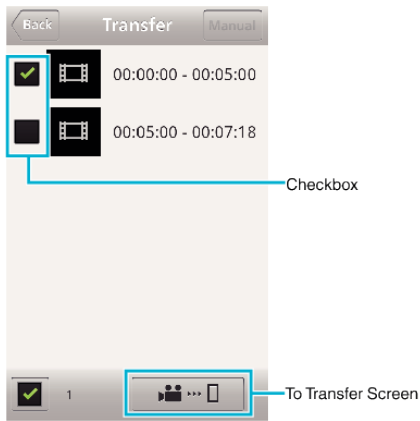

Game Score Screen



Caution :

- "Everio sync. 2" for iPhone/iPad cannot be used when the iPhone/iPad is connected to the mobile phone network. To make use of this feature, connect to the camera or an access point via Wi-Fi.

Using the Markings

Enter the mark to make it easy to find the scene later.

Common for Android and iOS

- 1 Tap "Marking" while recording the video.

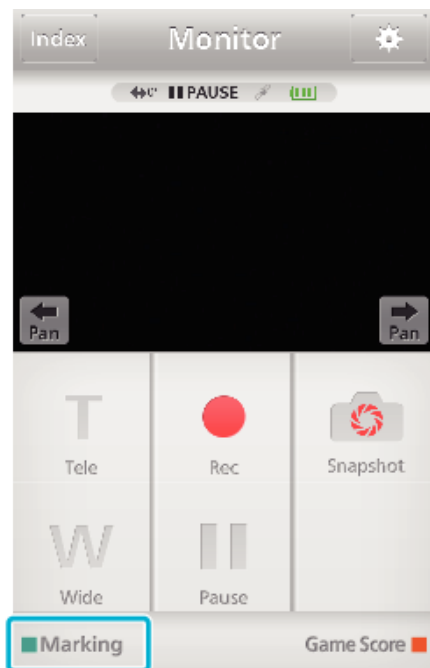

- 2 Tap the mark icon (🚩) at the scene you want to mark.



- Once a scene is marked, the next mark won't be made within 5 seconds.
- Tap "Monitor" to return to the monitor screen.

Screen display of the camera while marking

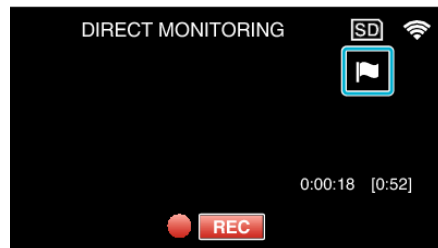

- The mark icon is displayed when a scene is marked.

Using the Game Score

The scores of various sport games can be recorded with video images. Also, the recorded position can be marked to make it easy to find the scenes you want to view later.

■ Common for Android and iOS

1 Tap "Game Score".

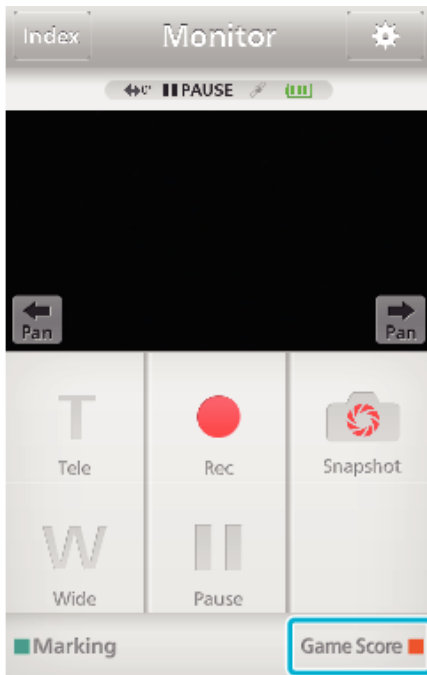

2 Tap the scorecard.



• Proceed to step 5 to keep the team settings unchanged.

3 Tap "TEAM SELECTION".

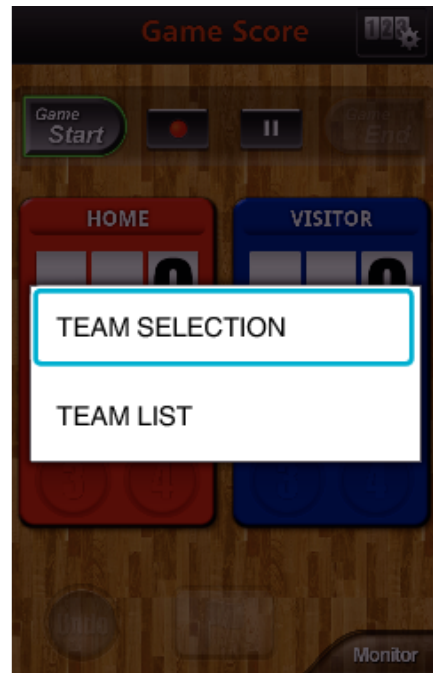

• Tap "TEAM LIST" to change the team name and color, and to add a team.

4 Select the team, then tap "OK".

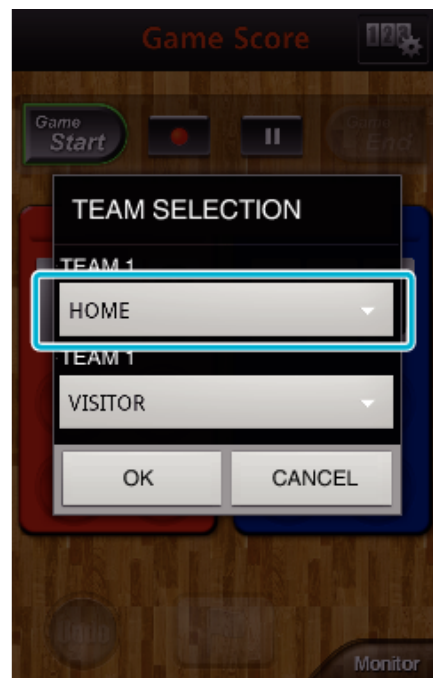

5 Tap ● to start recording the video.



- 6 When the game is started, tap “Game Start”.



- 7 Tap the number when the score is added.



- Tap the number button of the scored team.
- To modify the score, tap the scorecard.
- Tap the “Undo” button to cancel the latest score entry.
- When the score is registered, next entry cannot be made for 5 seconds.

- 8 Mark the favorite scenes.



- Mark the favorite scenes by tapping the flag icon (🚩).
- Once a scene is marked, the next mark won't be made within 5 seconds.

- 9 When the game is ended, tap “Game End”.



- Tap "OK" if "DO YOU WANT TO EXIT?" appears.
- After the end of the game, video recording is carried on until recording is stopped.
- Tap "Monitor" to return to the monitor screen in Step 1.

Memo :

- Team name and color, the background of the screen can be set prior to recording.
- Select the score button depending on the type of the games.
- The next score won't be registered within 5 seconds after the marking operation. But the score can be registered right after the marking operation by changing the game score setting.

"Game Score Settings" (p. 168)

Screen display of the camera while recording the game score



- 1 Team name and score
Team name can be set prior to recording. (use alphabets and numbers)

"Game Score Settings" (p. 168)

- 2 Game score recording icon

Transferring Videos (AVCHD format)

Transfer videos recorded in AVCHD format to the smartphone.

- The video to be forwarded is converted to the following format.

Item	Details	
System	MP4	
Video	Codec	H. 264/MPEG-4 AVC Baseline Profile
	Resolution * Bit rate is indicated in ()	1280X720 (3.6Mbps) 640X360 (1Mbps)
	Frame rate	25p
Audio	Coding system	AAC
	Sampling rate	48kHz
	Bit	16 bit
	Number of channels	2 ch

- 1 Start "Everio sync. 2" on the smartphone.



- Start the application after confirming that the smartphone is connected to this camera.

- 2 Select the connection type to the camera.



- Tap the current connection type.
- Recording screen appears.

- 3 Tap "Index".

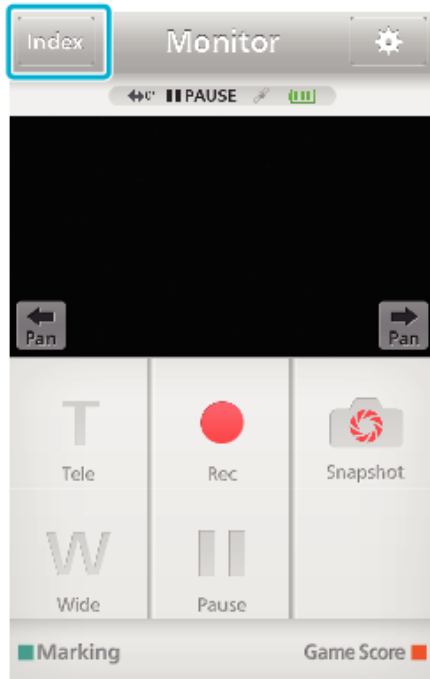

4 In the index screen, tap the desired images to transfer.



- Confirm that the “AVCHD” tab is indicated in the lower part of the screen.

5 Files are displayed as a split files by certain lengths of time. Enter the check mark (1) to the files to transfer, and tap the transfer mark icon (2) on the lower right.

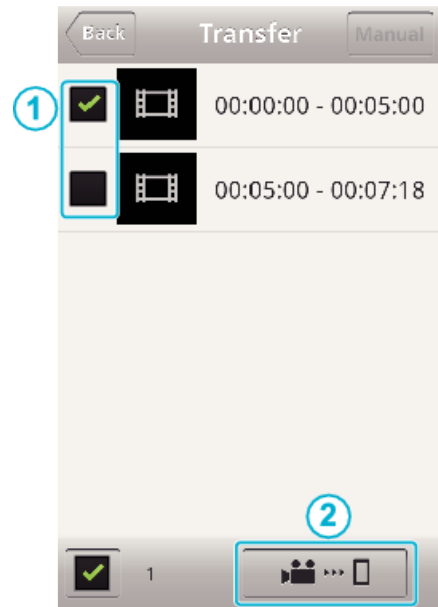

- Number of the selected image files is indicated next to the check mark in lower left.
- To set the length of video you are transferring, refer to the below instructions.
“Smartphone Application Settings” (p. 167)

6 Tap “TRANSFER”.

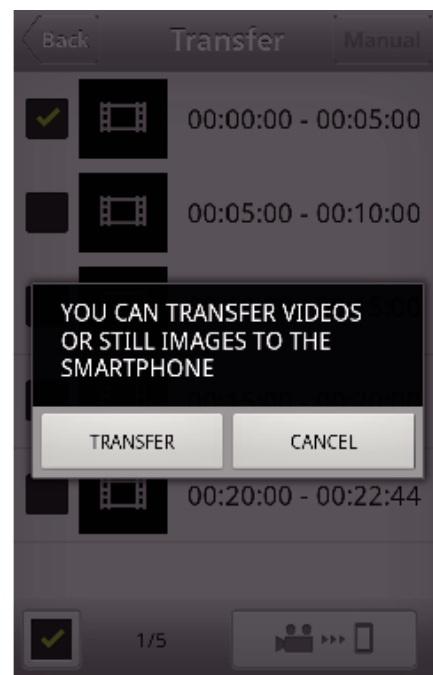

- Tap “CANCEL” to cancel the operation.

7 “TRANSFER” starts.

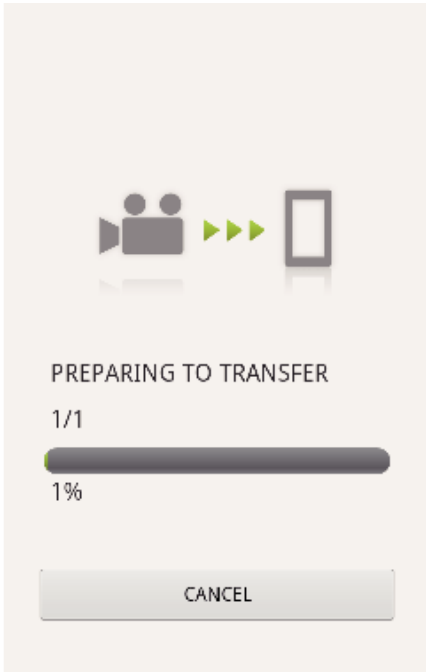

- Tap "CANCEL" to cancel the operation.

8 After transferring is complete, tap "OK".

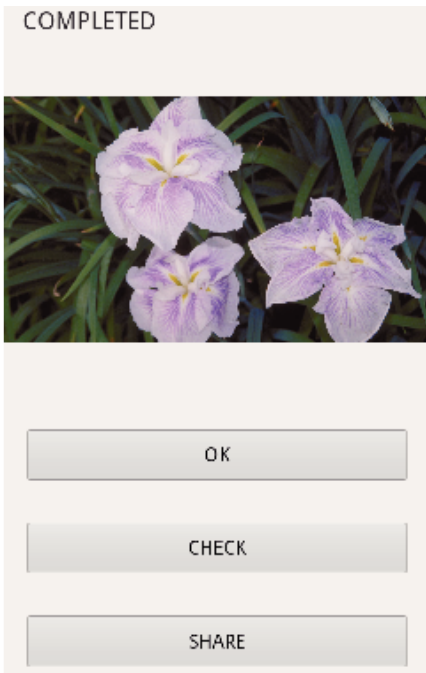

- To play back and check the video, tap "CHECK". (Android only)
- To upload the video, tap "SHARE". (Android only)
Tap the desired service, then proceed to the uploading process.
To make use of a service, it is necessary to perform registration beforehand.

■ Transferring manually

You can set the length of transferred video.

- 1 Tap "MANUAL" in step 5.
- 2 At the start point, enter the starting time of the video.
Specify the lengths of the video by using the slider bar. (10 to 300 sec)
- 3 After confirming the setting, tap "TRANSFER", and then tap "TRANSFER" one more time.

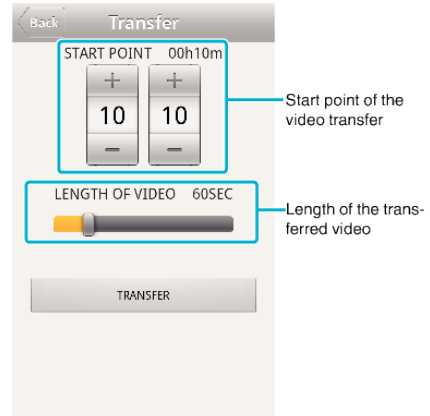

- Tap "+" "-" to set the start point of the video transfer (minutes/seconds).
- Length of the transferred video can be adjusted by using the slider bar.
- The longer the length of the transferred video is set, the longer it takes to transfer the video.

Transferring Videos (iFrame format)

Transfer videos recorded in iFrame format to the smartphone. (Depending on the smartphone in use, videos may not be played back.)

- Transferred videos are sent in the original file format.

1 Start “Everio sync. 2” on the smartphone.



- Start the application after confirming that the smartphone is connected to this camera.

2 Select the connection type to the camera.



- Tap the current connection type.
- Recording screen appears.

3 Tap “Index”.

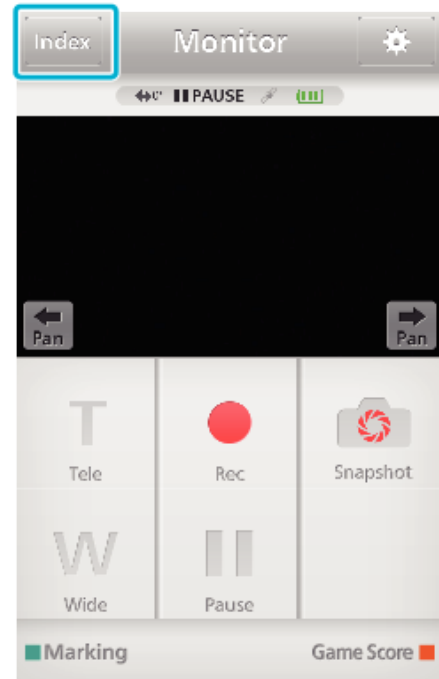

4 Select “iFrame” from the tabs in the lower part of the screen.



- Tap “Monitor” to return to the monitor screen.
- Tap ⚙️ to move to the setting screen.

5 In the index screen, tap the desired images to transfer.



- Tap "Monitor" to return to the monitor screen.
- Tap to move to the setting screen.

6 Tap "TRANSFER".

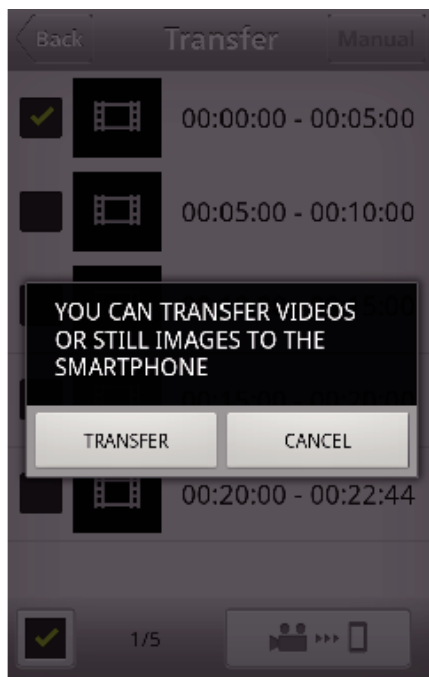

- Tap "CANCEL" to cancel the operation.

7 "TRANSFER" starts.

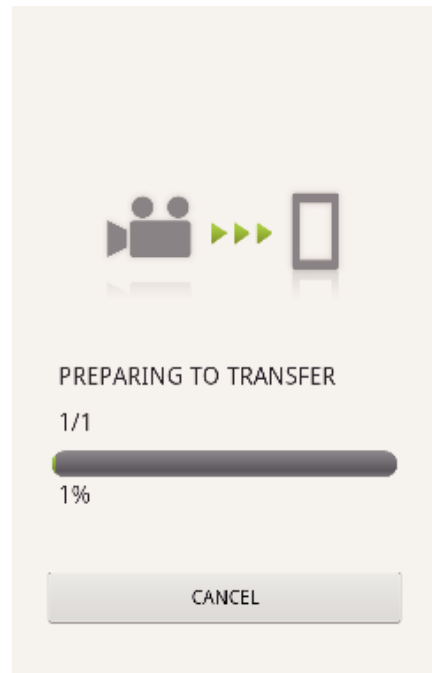

- Tap "CANCEL" to cancel the operation.

8 After transferring is complete, tap "OK".

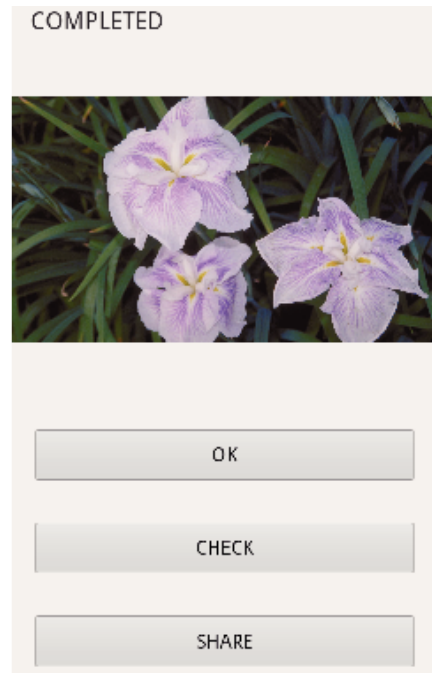

- To play back and check the video, tap "CHECK". (Android only)
- To upload the video, tap "SHARE". (Android only)
Tap the desired service, then proceed to the uploading process. To make use of a service, it is necessary to perform registration beforehand.

Transferring Still Images

You can transfer recorded still images to your smartphone.

If the aspect ratio of the original still image is 4:3, the image is reduced by 1600X1200 when transferred.

If the aspect ratio of the original still image is 16:9, the image is reduced by 1920X1080 when transferred.

- 1 Start "Everio sync. 2" on the smartphone.



- Start the application after confirming that the smartphone is connected to this camera.

- 2 Select the connection type to the camera.



- Tap the current connection type.
- Recording screen appears.

- 3 Tap "Index".

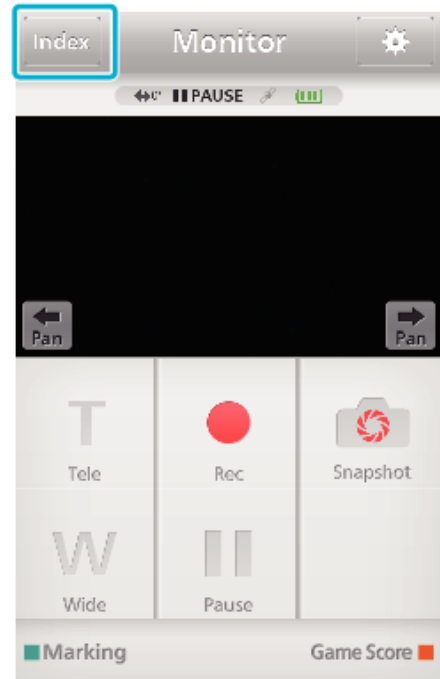



- 4 Select the "Still Image" tab in the lower part of the screen, and tap the index screen.

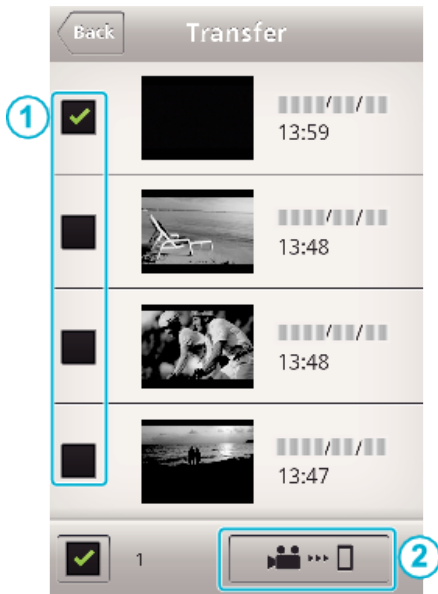

- Tap "Monitor" to return to the monitor screen.
- Tap ⚙️ to move to the setting screen.

- 5 Enter the check in the checkbox (①) to the still images to transfer, and tap the transfer mark icon (②) on the lower right.



- Tap "Monitor" to return to the monitor screen.
- Tap  to move to the setting screen.

6 Tap "TRANSFER".

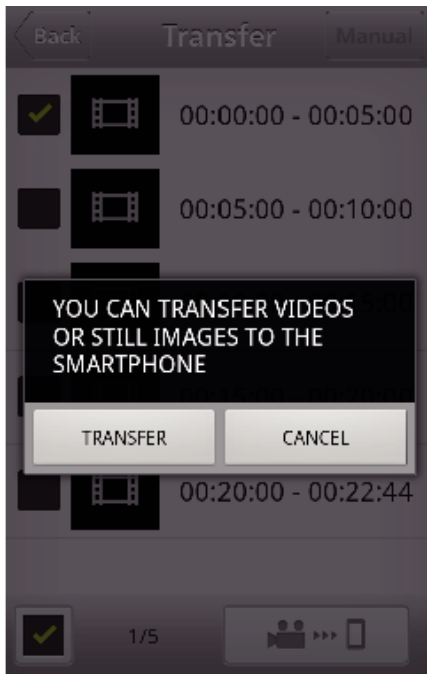

- Tap "CANCEL" to cancel the operation.

7 "TRANSFER" starts.

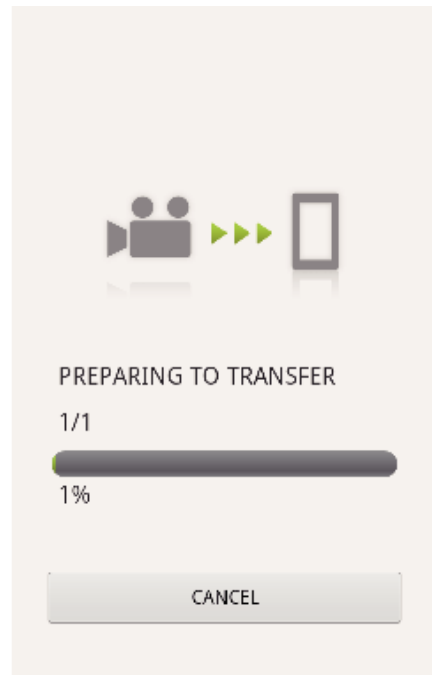

- Tap "CANCEL" to cancel the operation.

8 After transferring is complete, tap "OK".

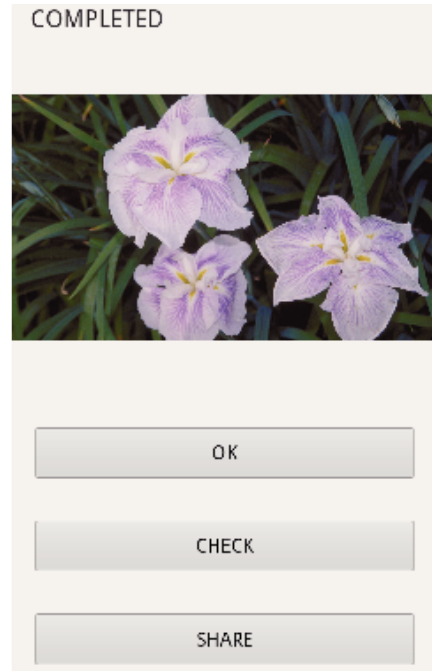

- To play back and check the still image, tap "CHECK". (Android only)
- To upload the still image, tap "SHARE". (Android only)
Tap the desired service, then proceed to the uploading process.
To make use of a service, it is necessary to perform registration beforehand.

Smartphone Application Settings

You can change the settings of the smartphone applications.

Common for Android and iOS

1 Tap .

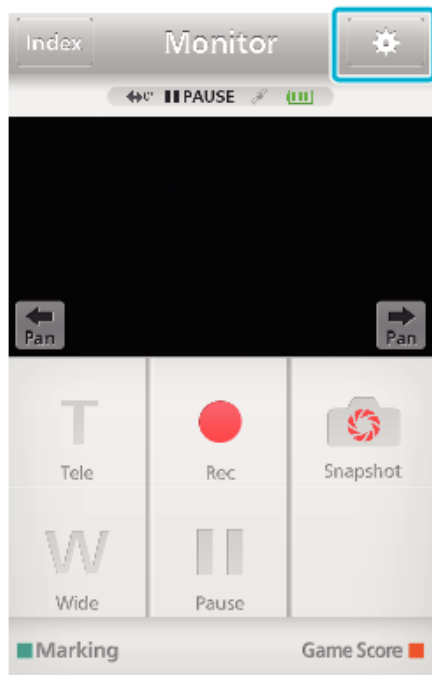

2 Tap the desired setting.

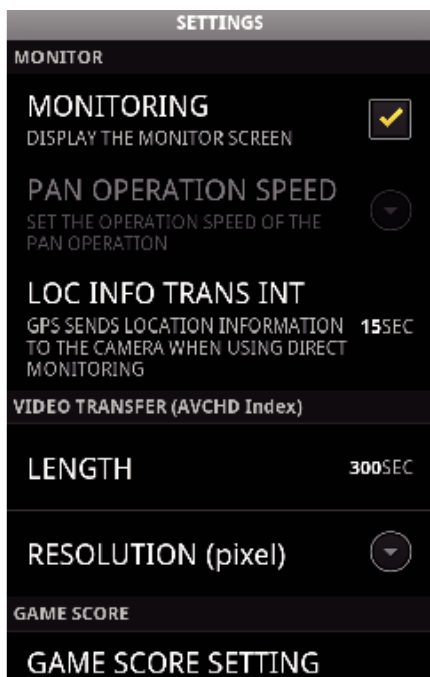

Item	Details
MONITORING	Turns on/off the monitoring function of the screen. (Enter a check mark to set to "ON")
PAN OPERATION SPEED	Select the panning speed of the pan cradle (optional) from high speed/low speed.
LOC INFO TRANS INT	Select the time interval for obtaining the GPS location information while the direct monitoring is in use. (Off - 15 SEC)
VID LENGTH TO TRANS	Set the length of video being transferred to the smartphone. (10 - 300SEC) Available for videos in AVCHD format only.
VID SIZE TO TRANS	Select the resolution of the video being transferred to the smartphone. ("1280x720" or "640x360") Available for videos in AVCHD format only.
GAME SCORE SETTING	Enter the recording methods of the game score, as well as the team information. "Game Score Settings" (p. 168)
URL	Enter the URL of the camera that is connected to the smartphone via wireless network.
HTTP AUTHORIZATION	Set the user name and the password for INDOOR MONITORING/OUTDOOR MONITORING. The default username is "everio" (fixed) and the password is "0000". (can be changed from camera)
CHANGE BACKGROUND COLOR	Select the background.
NOT TO SLEEP MODE	Set to prevent the smartphone from entering into the sleep mode while the application is in use. (Enter a check mark to deactivate the sleep mode.)
HELP	Displays the help file.
LICENSE AGREEMENT	Displays the license agreement of the software. (Android only)

Memo :

- When connecting to INDOOR MONITORING/OUTDOOR MONITORING, you will be prompted to enter the URL or HTTP authorization if they are not entered or entered incorrectly.

Game Score Settings

Enter the recording methods of the game score, as well as the team information.

■ Common for Android and iOS

1 Tap .

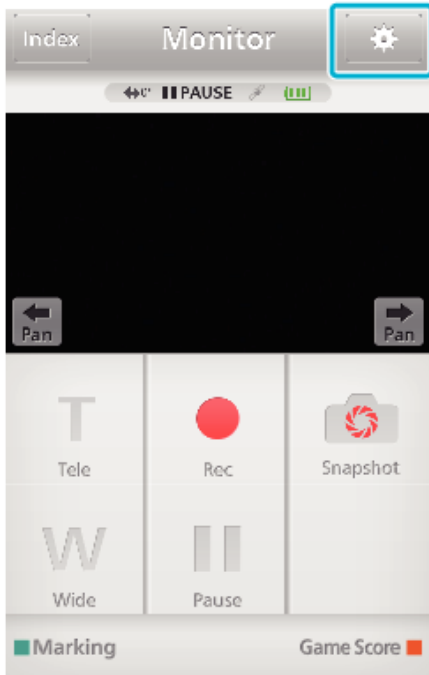

2 Tap "GAME SCORE SETTING".



3 Tap the desired setting.

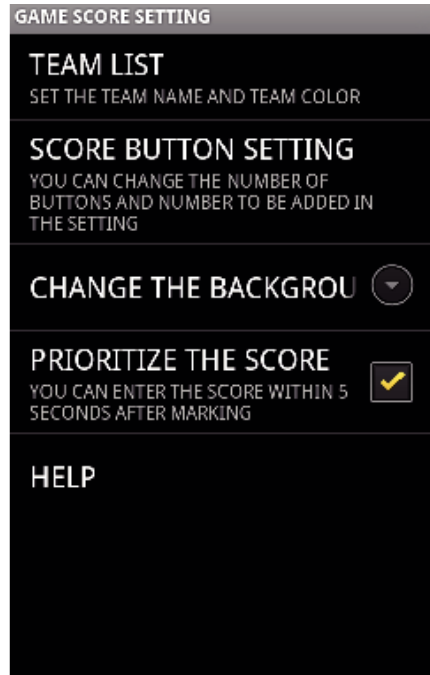

Item	Details
TEAM LIST	Set the team name and the color. To display "HOME" and "VISITOR", tap ①"TEAM LIST". ②"TEAM NAME" and "TEAM COLOR" can be set by tapping each button. ③ Select "TEAM NAME" to display the screen for entering the team name. Tap the column to enter the team name, and press "OK". ④Select "TEAM COLOR" by tapping the desired color from the color palette. Tap the + button to add a new team.
SCORE BUTTON SETTING	Tap "BUTTON SETTING" to select up to 4 buttons. Each number indicates the score that can be added once. Select the button(s) depending on the type of the games.  (1 button) (2 button) (3 button) (4 button)
CHANGE BACKGROUND COLOR	Set the background color of the game score screen.
PRIORITIZE THE SCORE	The score can be entered within 5 seconds after the mark operation by selecting the checkbox. However, the marked position is changed when the score is registered.
HELP	Displays the help file.

Memo :

- When registering the team name, the " " mark being entered by the smartphone is displayed as " \" (backslash) on this camera.

Using the Wi-Fi Function from a Web Browser

You can connect to the camera and make use of the Wi-Fi function from the web browser of a computer.

- Indications on the screen
- “Indications on the Screen” (p. 169)

Indications on the Screen

■ Recording Screen

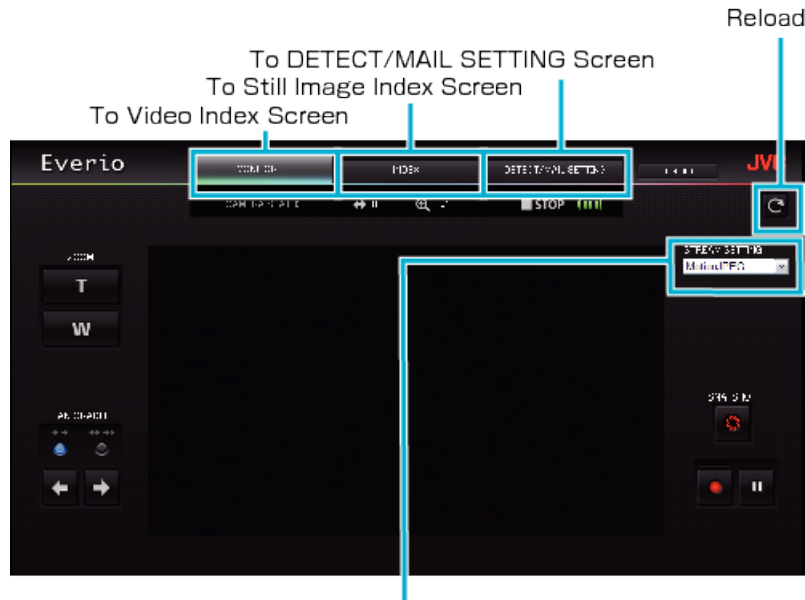

Stream Format Selection (click “SET” to apply) Select the video format when monitoring from a browser.

MotionJPEG	Full HD: 1920x1080 / MPEG-2 TS format
Full HD	SD: 720x576 / MPEG-2 TS format
SD	MotionJPEG: 640x360 / MotionJPEG format
MotionJPEG	

Memo :

- The full screen button is not displayed when the stream format is MotionJPEG.

Caution :

- Features of the stream format are as follows:
 - Full HD/SD (MPEG-2 TS format)
 - Sound of the camera can be checked from the browser.
 - Recording operations cannot be performed from the browser.
 - MotionJPEG
 - Sound of the camera cannot be played back from the browser.
 - Recording and zoom operations can be performed from the browser.
- The monitor's image stops automatically after monitoring is performed continuously for 12 hours in Full HD or SD. (To resume, press the reload button)
- To use Full HD or SD, it is necessary to install Media Player 12 in advance.
- Lagging of the screen may be caused by the network speed or computer performance.
- If lagging is severe, reload the screen regularly. (It may take some time for the screen to be displayed after reloading.)
- For Full HD, make use of a computer with the following system requirements.
 - CPU Intel Core 2 Duo 2 GHz or higher
 - 2 GB memory or higher

■ Video Index Screen (Thumbnail Display) (AVCHD)

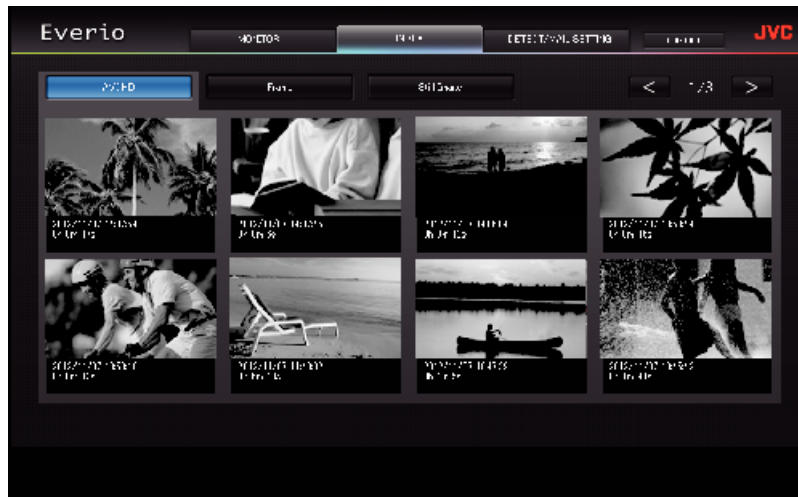

■ Video Index Screen (Thumbnail Display) (iFrame)

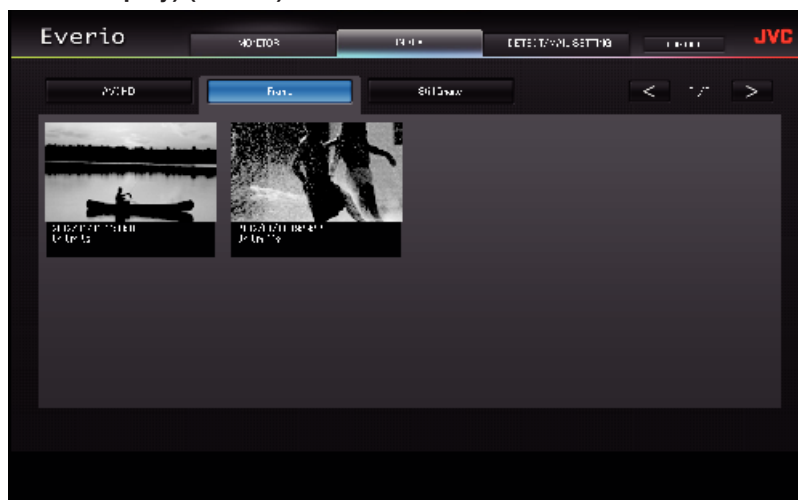

- To download a video, click on the thumbnail.

■ Still Image Index Screen (Thumbnail Display)

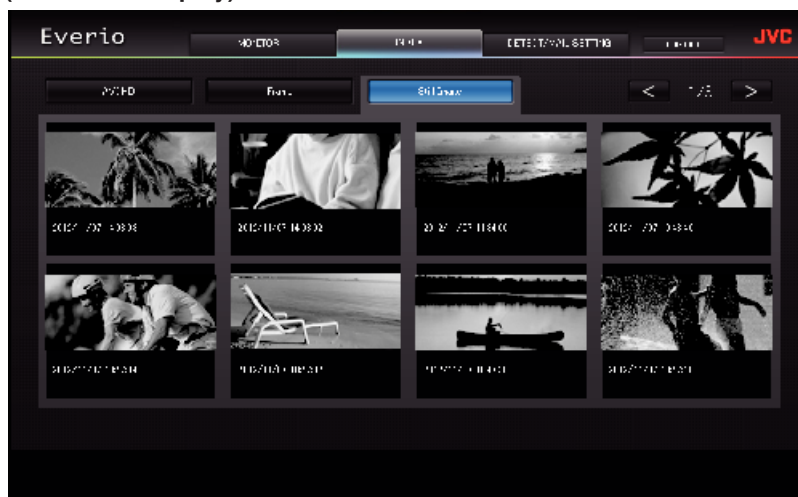

- To download a still image, click on the thumbnail.

■ DETECT/MAIL SETTING Screen

Notification mail settings such as detection method and recipient's e-mail address can be changed even when the camera is out of reach.

Registered e-mail addresses of recipients in Everio (Up to 8)

*A check mark appears on the selected address.



Notification Mail Settings

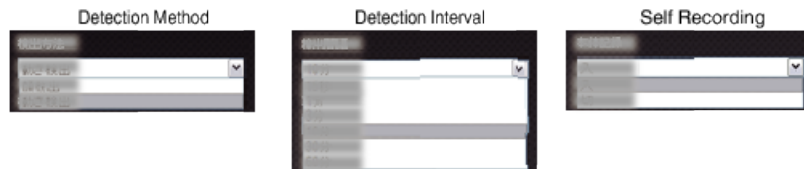

(click "REG." to apply)

Troubleshooting

Direct Monitoring

Trouble	Action
Unable to connect to camera. (URL required)	<ul style="list-style-type: none"> • Check whether the Wi-Fi connection is established successfully. • Check whether Wi-Fi is connected to "DIRECT-**EVERIO". • Check whether the smartphone (or computer) is connected to the camera. • Try again after powering off and on the camera and the terminal (smartphone or computer).
Unable to browse internet on the computer when it is connected to the camera.	<ul style="list-style-type: none"> • The camera operates as an access point during direct monitoring. Most computers (or smartphones) cannot be connected to multiple access points at the same time. As such, internet browsing becomes temporarily unavailable if the computer (or smartphone) has been connected to the internet via wireless LAN. • Reconnect the computer to the wireless LAN router that is usually used for internet connection. If the computer connects to the camera unintentionally, remove the camera connection from the computer. (The registered name is "DIRECT-**EVERIO".) • Stop direct monitoring on the camera.
Video or audio is interrupted or delayed	<ul style="list-style-type: none"> • If the network speed is slow, videos and audio sound may be interrupted, or delay may become significant. • (For web browser) Lagging may become significant due to the performance of the computer. If the stream format is set to "Full HD", change to "SD" or "Motion-JPEG" and try again. <p>"Wi-Fi Specifications" (☞ p. 176)</p> <ul style="list-style-type: none"> • (For web browser) If lagging is severe, reload the screen regularly. • (For smartphone) Try to change the place and time to locate an environment with good signal strength.
The unit turns off automatically.	<ul style="list-style-type: none"> • To prevent the situation of forgetting to turn off the power, this unit will turn off automatically after 10 days of continuous usage.
Unable to set focus.	<ul style="list-style-type: none"> • When not monitoring from a smartphone (or computer), the focus of the camera is fixed. • Even when monitoring from a smartphone (or computer), the focus of the camera will be fixed if not operated for more than 3 hours. (Focus works again when the camera is operated.)
Connection gets disconnected, or a "UNABLE TO CONNECT" message is displayed	<ul style="list-style-type: none"> • Establish connection again at a place with good signal strength. Transmission speed may drop, or connection may fail if the devices are placed too far away from each other, when there are objects in between, or when microwave ovens or other wireless devices are in use. • If connection cannot be established again, restart the terminal (smartphone or computer). • If the camera is too far away from the smartphone (or computer), connection for direct monitoring may be difficult to be established depending on the environment. In this case, connect via an access point (wireless LAN router).

Access Point (Wireless LAN Router)

Trouble	Action
Unable to find an access point (wireless LAN router).	<ul style="list-style-type: none"> • Check whether the distance from the access point (wireless LAN router) is too far, or whether there are shielding materials in between. • If the access point (wireless LAN router) in use goes into the SSID stealth mode, perform manual registration or disable the stealth mode temporarily before registering. • In an environment with multiple access points, you may not be able to find the desired access point through searching. In this case, add the access point manually.
Unable to connect to access point (wireless LAN router).	<ul style="list-style-type: none"> • Check that the password is correct. • For manual connection, check that the SSID or authentication method is correct.
Unsure of which access point (wireless LAN router) to use.	<ul style="list-style-type: none"> • If the settings of the access point (wireless LAN router) have never been changed from their default values, check the following. <ul style="list-style-type: none"> - Check whether an adhesive label indicating the initial settings is attached to the body of the access point (wireless LAN router). - Check for the default settings in the instruction manual of the access point (wireless LAN router).
Unsure of password for the access point (wireless LAN router).	Refer to the instruction manual of the access point (wireless LAN router) in use.
Unable to connect via Wi-Fi Protected Setup (WPS).	<ul style="list-style-type: none"> • Simple connection methods other than WPS are not supported. Conduct a search for the access point to connect. • Turn off the power of the camera, then try again.

INDOOR MONITORING (connection at home)

Trouble	Action
Unable to connect to camera. (URL required)	<ul style="list-style-type: none"> • Check whether the Wi-Fi connection is established successfully. • Check to ensure that the camera and the terminal (smartphone or computer) are connected to the same access point. • Try again after powering off and on the camera and the terminal (smartphone or computer).
Unsure of URL to access from a web browser.	<ul style="list-style-type: none"> • After INDOOR MONITORING is started, tap "CAMERA NETWORK INFO." shown on the camera's screen. Enter the address as shown in "URL(LAN):" into the web browser to access it.
No image and sound when accessing from a web browser.	<ul style="list-style-type: none"> • If you have installed third-party video players, images and sounds may not be played back properly. • If the stream format is set to "Motion-JPEG" when transferring to the web browser, no sound will be output from the browser. • If recording of the video is in progress, no sound will be output from the browser.
Unable to access the entered URL. (cannot be found)	<ul style="list-style-type: none"> • Check that the camera is properly connected to an access point (wireless LAN router). (Wi-Fi appears on the camera's screen.) • Check that the computer is properly connected to an access point (wireless LAN router). Connection should be possible if it is connected to the internet. • Check that the URL is correct.
Unable to access the entered URL. (password required)	<ul style="list-style-type: none"> • Enter your username and password. The username is "everio" (fixed) and the default password is "0000" (can be changed).
Video or audio is interrupted or delayed	<ul style="list-style-type: none"> • If the network speed is slow, videos and audio sound may be interrupted, or delay may become significant. • (For web browser) Lagging may become significant due to the performance of the computer. If the stream format is set to "Full HD", change to "SD" or "Motion-JPEG" and try again. "Wi-Fi Specifications" (p. 176) • (For web browser) If lagging is severe, reload the screen regularly. • (For smartphone) Try to change the place and time to locate an environment with good signal strength.
The unit turns off automatically.	<ul style="list-style-type: none"> • To prevent the situation of forgetting to turn off the power, this unit will turn off automatically after 10 days of continuous usage.
Unable to set focus.	<ul style="list-style-type: none"> • When not monitoring from a smartphone (or computer), the focus of the camera is fixed. • Even when monitoring from a smartphone (or computer), the focus of the camera will be fixed if not operated for more than 3 hours. (Focus works again when the camera is operated.)
Connection gets disconnected, or a "UNABLE TO CONNECT" message is displayed	<ul style="list-style-type: none"> • Establish connection again at a place with good signal strength. Transmission speed may drop, or connection may fail if the devices are placed too far away from each other, when there are objects in between, or when microwave ovens or other wireless devices are in use. • If connection cannot be established again, restart the terminal (smartphone or computer).
Screen does not refresh or remains black	<ul style="list-style-type: none"> • Check if the camera and the access point are properly connected. Images cannot be detected on the terminal (smartphone or computer) if the camera is disconnected from the access point halfway through.

OUTDOOR MONITORING (connection from the Internet)

Trouble	Action
Unsure of URL to access from a web browser.	<ul style="list-style-type: none"> After OUTDOOR MONITORING is started, tap "CAMERA NETWORK INFO." shown on the camera's screen. Enter the address as shown in "URL(WAN):" into the web browser to access it.
The URL (WAN) does not appear in the network information.	<ul style="list-style-type: none"> The URL (WAN) will not appear if dynamic DNS is not set on the camera. To set dynamic DNS, perform the following steps. <ol style="list-style-type: none"> Obtain an account with JVC dynamic DNS service using your computer. Log in to JVC DNS and obtain the dynamic DNS service. Set the obtained dynamic DNS username and password on the camera. *Only the JVC dynamic DNS service can be set on this camera. The URL (WAN) will not appear if dynamic DNS is not set on the camera. To set dynamic DNS, perform the following steps. <ol style="list-style-type: none"> Obtain an account with JVC dynamic DNS service using your computer. https://dd3.jvckenwood.com/user/ Log in to JVC DNS and obtain the dynamic DNS service. Set the obtained dynamic DNS username and password on the camera. *Only the JVC dynamic DNS service can be set on this camera.
Unable to access the entered URL. (cannot be found)	<ul style="list-style-type: none"> This function cannot be used in an environment with two or more routers. Check that the dynamic DNS username and password are correct. The router in use is not compatible with UPnP, or UPnP is turned off. Check the instruction manual of the router in use, and turn on UPnP. The "UPnP" of the camera is set to "OFF". (By default, it is set to "ON".) Set "UPnP" to "ON". Depending on the terms of service with your provider, it may not be possible to obtain a global IP address. "Confirming global IP address" (☞ p. 120) Check whether a terminal that uses port 80 (such as web servers) has been set in the network, or if a specific terminal has been set to use port 80 on the router. In such case, change the "HTTP Port" of the camera. "Changing the HTTP Port (DIRECT MONITORING/INDOOR MONITORING/OUTDOOR MONITORING)" (☞ p. 137) Try again after powering off and on the camera and the terminal (smartphone or computer).
Video or audio is interrupted or delayed	<ul style="list-style-type: none"> If the network speed is slow, videos and audio sound may be interrupted, or delay may become significant. (For web browser) Lagging may become significant due to the performance of the computer. If the stream format is set to "Full HD", change to "SD" or "Motion-JPEG" and try again. "Wi-Fi Specifications" (☞ p. 176) (For web browser) If lagging is severe, reload the screen regularly. (For smartphone) Try to change the place and time to locate an environment with good signal strength.
The unit turns off automatically.	<ul style="list-style-type: none"> To prevent the situation of forgetting to turn off the power, this unit will turn off automatically after 10 days of continuous usage.
Unable to set focus.	<ul style="list-style-type: none"> When not monitoring from a smartphone (or computer), the focus of the camera is fixed. Even when monitoring from a smartphone (or computer), the focus of the camera will be fixed if not operated for more than 3 hours. (Focus works again when the camera is operated.)
Connection gets disconnected, or a "UNABLE TO CONNECT" message is displayed	<ul style="list-style-type: none"> Establish connection again at a place with good signal strength. Transmission speed may drop, or connection may fail if the devices are placed too far away from each other, when there are objects in between, or when microwave ovens or other wireless devices are in use. If connection cannot be established again, restart the terminal (smartphone or computer).
Screen does not refresh or remains black	<ul style="list-style-type: none"> Check if the camera and the access point are properly connected. Images cannot be detected on the terminal (smartphone or computer) if the camera is disconnected from the access point halfway through.
"XUPnP" is displayed.	<p>This appears when UPnP has failed.</p> <ul style="list-style-type: none"> Check whether the wireless LAN router in use is compatible with UPnP. (Refer to the instruction manual of the wireless LAN router in use, or consult the manufacturer of the router.) When the wireless LAN router in use is compatible with UPnP, turn on the UPnP function. If the icon does not disappear even when the UPnP function is enabled, turn off and on the power of the wireless LAN router in use as well as the camera, then try again.
Unable to connect although "XUPnP" is displayed.	<ul style="list-style-type: none"> When "UPnP" is set to "OFF", "XUPnP" will not appear. In such cases, set "UPnP" to "ON". When port 80 has been used by other devices via UPnP, connection cannot be established. Reconnect the camera.

- When the “HTTP Port” of the camera (set to “80” by default) is used by another device, connection cannot be established. Change the “HTTP Port” of the camera.
- “Changing the HTTP Port (DIRECT MONITORING/INDOOR MONITORING/OUTDOOR MONITORING)”
( p. 137)

E-mail (Notification Mail, Video Mail)

Trouble	Action
Unable to send e-mails.	<ul style="list-style-type: none"> • Check that the settings of the e-mail server are correct. • Check that the settings of the sender's e-mail address are correct. • Check that the username and password are correct. • If you are using an e-mail service that is not from your provider, it may be necessary to change the SMTP settings. • Some free e-mail services from web browsers or e-mail softwares (SMTP) may have default SMTP settings that do not allow e-mails to be sent. Change the SMTP settings to allow sending of e-mails before use.
Sent e-mails are not received.	<ul style="list-style-type: none"> • Check whether notifications indicating errors have been sent to the sender's e-mail address. (Make use of a computer or similar devices as it is not possible to check from the camera.) - If no notifications are received: Refer to “Unable to send e-mails.” and adjust the settings accordingly. - If notifications are received: Check the content of the notification. <p>*Note: Do not continue sending e-mails with the same settings if you receive error notifications. Depending on the provider, you may be marked as a sender of spam (junk mail).</p>
Unable to attach images to e-mails.	<ul style="list-style-type: none"> • Depending on the provider, some attached files may be deleted. Make use of other free e-mail services.
The unit turns off automatically.	<ul style="list-style-type: none"> • To prevent the situation of forgetting to turn off the power, this unit will turn off automatically after 10 days of continuous usage.
Unable to set focus.	<p>(For DETECT/MAIL SETTING)</p> <ul style="list-style-type: none"> • While on standby for notification mails, the focus is fixed. Perform the camera settings first, then enable notification mails. Focus may not be set correctly if the notification mails start before camera settings are made. In this case, disable notification mails temporarily, then enable it again.

Vide/Still Image Transmission

Trouble	Action
Unable to transfer videos and still images to smartphone (or computer).	<ul style="list-style-type: none"> • Check the amount of remaining free space in the destination medium (smartphone or computer).

Wi-Fi Specifications

Wi-Fi Specifications

Item	Details
Wireless LAN Standard	IEEE802.11b/g/n (2.4GHz band)
Wi-Fi security	Encryption: WEP, WPA, WPA2 *WPA and WPA2 are supported only by the personal mode (PSK).

DIRECT MONITORING / INDOOR MONITORING / OUTDOOR MONITORING

■ When Using Everio sync. 2

Item	Details
Supported Terminals	<p>iPhone/iPad/iPod touch: iOS 5.1 or later Android: Android 2.3 or later</p> <ul style="list-style-type: none"> There is no guarantee that the operations will work with all terminals. "Everio sync. 2" for iPhone/iPad cannot be used when the iPhone/iPad is connected to the mobile phone network. To make use of this feature, connect to the camera or an access point via Wi-Fi. A network environment with a minimum line speed of about 5.3 Mbps is recommended for both the camera sending the data and the smartphone terminal receiving the data. If the network speed is too low, video images may appear jumpy, or audio sound may be interrupted or delayed.
Monitor Screen	<p>Video: JPEG 640x360 max. 12.5 fps Audio: linear PCM 8kHz 16 bits 1ch</p>
Video Transmission	<p>Video: MP4-compliant H.264 Baseline Profile 640x360 or 1280x720 25p Audio: AAC 48kHz 16 bits 2ch</p>
Still Image Transmission	JPEG format

■ When Using Web Browser

Item	Details
Operating Environment	<p>Windows 7: Internet Explorer 9 or a later version, and Windows Media Player 12 or a later version are installed</p> <ul style="list-style-type: none"> For Full HD, make use of a computer with the following system requirements. <ul style="list-style-type: none"> CPU: Intel Core 2 Duo 2 GHz or higher Memory: 2 GB or higher A network environment with the following line speed is recommended for both the camera sending the data and the PC receiving the data. <ul style="list-style-type: none"> MotionJPEG: approx. 1.7 Mbps or higher Full HD: approx. 10 Mbps or higher SD: approx. 3 Mbps or higher <p>If the network speed is too low, video images may appear jumpy, or audio sound may be interrupted or delayed.</p>
Monitor Screen	<ul style="list-style-type: none"> MotionJPEG Video: JPEG 640x360 max. 5 fps Audio: nil Full HD Video: MPEG-2 TS compliant H.264 High Profile 1920x1080 50i Audio: AAC 48kHz 16 bits 2ch SD Video: MPEG-2 TS compliant H.264 Main Profile 720x576 50i Audio: AAC 48kHz 16 bits 2ch
Video Transmission	MPEG-2TS format (no conversion)
Still Image Transmission	JPEG format (no conversion)

VIDEO MAIL

Item	Details
Video	MP4-compliant H.264 Baseline Profile 640x360 25p

Audio	AAC 48kHz 16 bits 2ch
Time	Max. 15 seconds

DETECT/MAIL

Item	Details
Still Image Transmission	JPEG 640x360

DIRECT MONITORING

You can monitor images being captured by Everio to your smartphone or PC. While you are busy, you can monitor your baby who is sleeping in the room next door.

INDOOR MONITORING

Images being captured by Everio can be set to your PC or smartphone when your children return home, via the wireless LAN router.

OUTDOOR MONITORING

Images being captured by Everio can be sent to the grandparents' PC or smartphone, by the wireless LAN (Wi-Fi spot) via the Internet.

DETECT/MAIL

When your child returns home while you are away, a still image is sent to you by e-mail.

VIDEO MAIL

Let's send video messages (Good morning, Good night) to your father or husband who is on the business trip.

TV MONITORING

A DLNA compatible TV may be used to display and play back the images.

DIRECT MONITORING

- **Setting (Once setting is done, start from the “Regular Operation” below)**

Create a QR code.

- **Enter values in the required items for direct monitoring.**

- Password: set a password to connect this camera to the device by direct monitoring. (8 to 63 characters (64 characters in case of hexadecimal))
- Enforced Group Owner: setting used to enable a connection with a device that does not support Wi-Fi Direct. Normally set to “ON”.
- HTTP Port: Normally set to “80”.

Display the screen for reading the QR code.

- 1 Tap “MENU”.
(Operation on this camera)



- The top menu appears.

- 2 Tap the “Wi-Fi” (Wi-Fi icon).
(Operation on this camera)

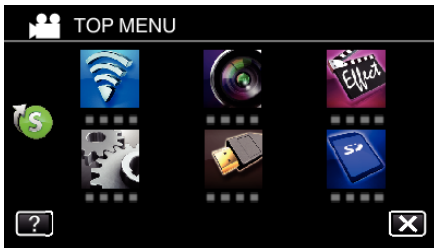

- 3 Tap > on the lower right of the screen.
(Operation on this camera)

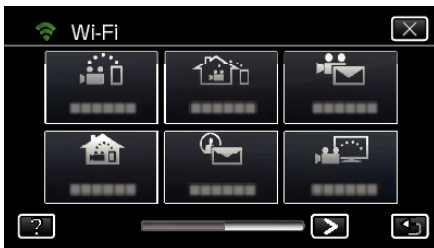

- 4 Tap “COMMON Wi-Fi SETTING”.
(Operation on this camera)



- 5 Tap “SET FROM QR CODE”.

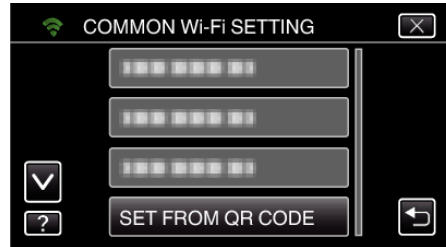

- 6 Tap “EXECUTE”.



Read a QR code.

- 1 Read a QR code.
(Operation on this camera)

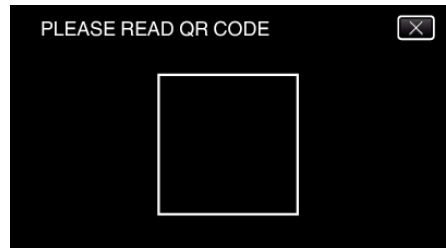

- 2 Tap “YES”.

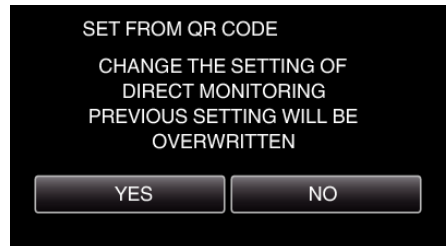

- 3 Tap “OK”.

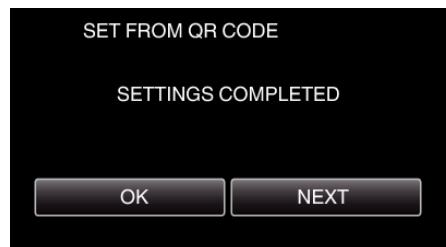

- Tap “NEXT” to return to the screen to read the QR code.
- Set contents are saved.

Regular Operation

Connecting the Smartphone to the Camera Wirelessly

Connection by entering the Wi-Fi password

- 1 Tap "MENU".
(Operation on this camera)
Set the camera to the recording mode.

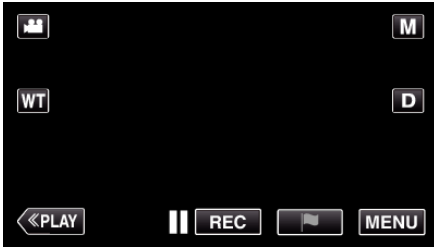

- The top menu appears.

- 2 Tap the "Wi-Fi" (Wi-Fi icon).
(Operation on this camera)

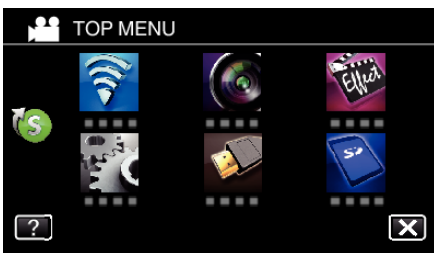

- 3 Tap the "DIRECT MONITORING" (Wi-Fi icon) icon in the "Wi-Fi" menu.
(Operation on this camera)



- 4 Tap "START" (right arrow).
(Operation on this camera)



- When iFrame is selected for "VIDEO REC FORMAT", the following display appears and recording mode is switched to the 50i mode in AVCHD.
- This display disappears automatically after approximately 3 seconds, but disappears immediately if the screen is tapped.



- 5 Check the SSID and the PASS being displayed on the screen of the camera.



- 6 Select the SSID in step 5 from the Wi-Fi network selection screen of your smartphone, and enter the PASS on the password screen.
(Operation on the smartphone (or computer))



- For details on connecting your smartphone (or computer) to a Wi-Fi network, please refer to the instruction manual of the phone terminal in use.

- 7 A connection is established and Wi-Fi appears on the camera's screen.



Connection by Wi-Fi Protected Setup (WPS)

- 1 Tap "MENU".
(Operation on this camera)
Set the camera to the recording mode.

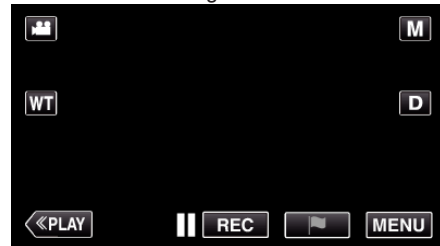

- The top menu appears.

- 2 Tap the "Wi-Fi" (Wi-Fi icon).
(Operation on this camera)



- 3 Tap the "DIRECT MONITORING" (Wi-Fi icon) icon in the "Wi-Fi" menu.
(Operation on this camera)

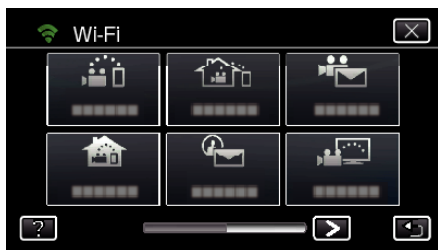

4 Tap "START" (→).
(Operation on this camera)



- When iFrame is selected for "VIDEO REC FORMAT", the following display appears and recording mode is switched to the 50i mode in AVCHD.
- This display disappears automatically after approximately 3 seconds, but disappears immediately if the screen is tapped.



5 Tap "WPS".
(Operation on this camera)



6 Activate WPS on the smartphone (or computer) within 2 minutes.
(Operation on the smartphone (or computer))



- To activate WPS, refer to the instruction manual of the device in use.

7 A connection is established and  appears on the camera's screen.



Monitoring the Images from a Smartphone (or Computer)

Smartphone (Android / iPhone)

Memo : _____

- Prior to use this function, a smartphone application needs to be installed on the smartphone.
- "Installing Smartphone Applications" (☞ p. 156)

1 Start "Everio sync. 2" on the smartphone after setting DIRECT MONITORING.



2 Tap "DIRECT MONITORING".



3 The recording screen is displayed.

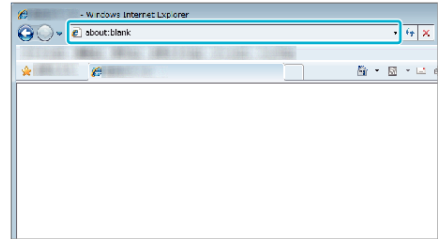

4 Operate from a smartphone



- How to operate from a smartphone
“Using Smartphone Applications” (p. 156)

■ Computer (Windows 7)

- 1 Tap the URL button shown on the camera’s screen.
(displayed when the computer and the camera are connected wirelessly.)



- The URL for the computer to connect to appears.

- 2 Check the URL being displayed on the camera screen, which starts from “http://”.



- After checking the URL, tap “QUIT” to return to the previous screen.

- 3 Start Internet Explorer (web browser) on the computer and enter the URL.

INDOOR MONITORING

- **Setting (Once setting is done, start from the “Regular Operation” below)**

Create a QR code.

- **Enter values in the required items for indoor monitoring.**

- Password: set a password to connect this camera to the device via access point. (Not more than 8 characters)
- HTTP Port: Normally set to “80”.

Display the screen for reading the QR code.

- 1 Tap “MENU”.
(Operation on this camera)



- The top menu appears.

- 2 Tap the “Wi-Fi” (📶) icon.
(Operation on this camera)

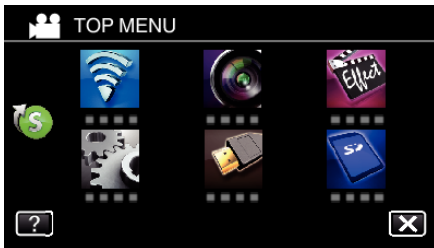

- 3 Tap > on the lower right of the screen.
(Operation on this camera)

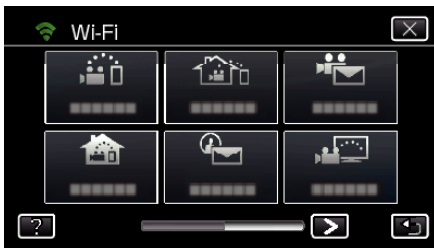

- 4 Tap “COMMON Wi-Fi SETTING”.
(Operation on this camera)



- 5 Tap “SET FROM QR CODE”.



- 6 Tap “EXECUTE”.



Read a QR code.

- 1 Read a QR code.
(Operation on this camera)

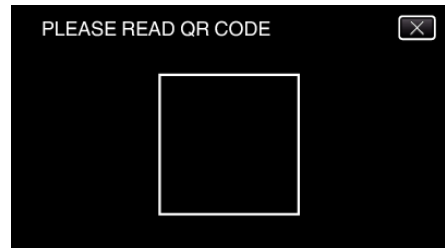

- 2 Tap “YES”.

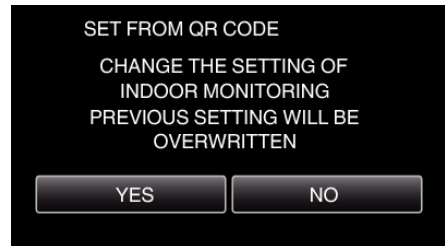

- 3 Tap “OK”.

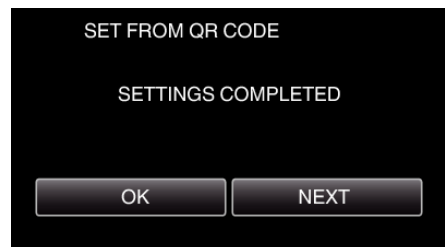

- Tap “NEXT” to return to the screen to read the QR code.
- Set contents are saved.

Registering the access points (wireless LAN router) to this unit

■ Wi-Fi Protected Setup (WPS) Registration

- 1 Tap “MENU”.
(Operation on this camera)



- The top menu appears.

2 Tap the “Wi-Fi” (Wi-Fi icon).
(Operation on this camera)

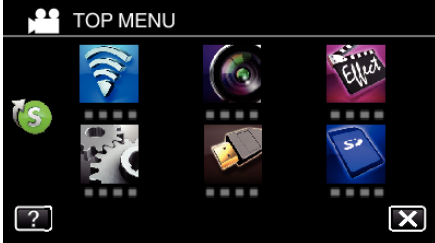

3 Tap > on the lower right of the screen.
(Operation on this camera)

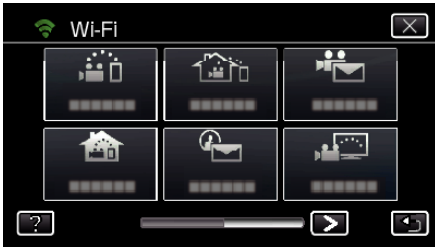

4 Tap “COMMON Wi-Fi SETTING”.
(Operation on this camera)

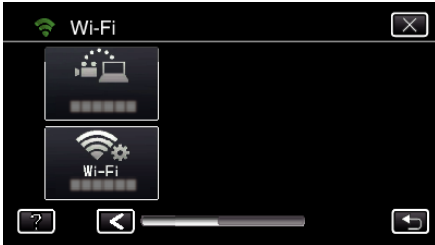

5 Tap “ACCESS POINTS”.
(Operation on this camera)



6 Tap “ADD”.
(Operation on this camera)



7 Tap “EZ REGISTRATION WPS”.
(Operation on this camera)

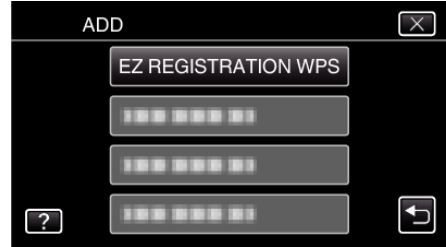

- 8 Activate WPS of the access point (wireless LAN router) within 2 minutes.
 - To activate WPS, refer to the instruction manual of the device in use.
- 9 After registration is complete, tap “OK” on the camera’s screen.
(Operation on this camera)



■ Search the access point, and select from the list.

Set the name (SSID) of the access point (wireless LAN router) and the password beforehand.

1 Tap “MENU”.
(Operation on this camera)



- The top menu appears.

2 Tap the “Wi-Fi” (Wi-Fi icon).
(Operation on this camera)

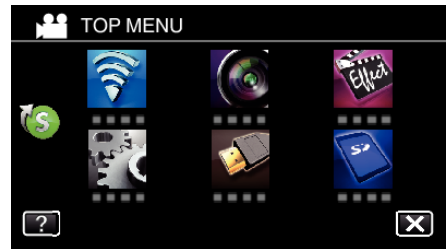

3 Tap > on the lower right of the screen.
(Operation on this camera)

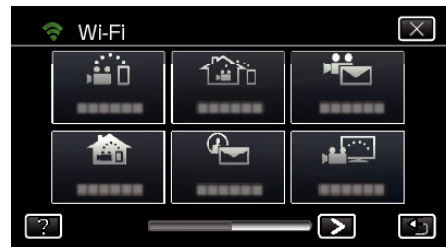

4 Tap “COMMON Wi-Fi SETTING”.
(Operation on this camera)



- 5 Tap "ACCESS POINTS".
(Operation on this camera)

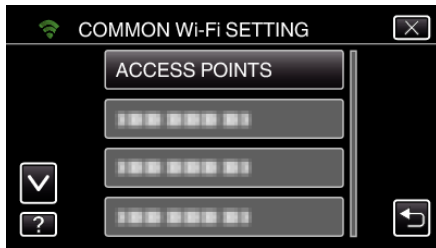

- 6 Tap "ADD".
(Operation on this camera)



- 7 Tap "SEARCH".
(Operation on this camera)

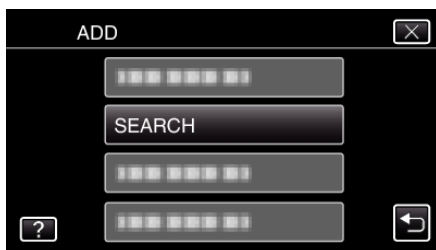

- The search results appear on the camera's screen.

- 8 Tap the name (SSID) of the desired access point from the list of search results.
(Operation on this camera)

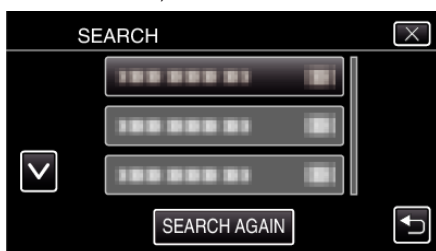

- 9 Register a password.
(Operation on this camera)



- Tap on the on-screen keyboard to enter characters. The character changes with every tap.

"ABC", for example, enter "A" by tapping once, "B" by tapping twice, or "C" by tapping 3 times.

- Tap "DELETE" to delete a character.
- Tap "CANCEL" to exit.
- Tap "A/a/1" to select character input type from upper case letter, lower case letter, and number.
- Tap ← or → to move one space to the left or right.
- The password is not required if the wireless LAN router is not security protected.

- 10 After registration is complete, tap "OK" on the camera's screen.
(Operation on this camera)



- Other methods, such as "Manual Registration" and "WPS PIN Registration" are also available. Refer to the following link for details. "Registering the Access Points of the Camera to Connect (ACCESS POINTS)" (p. 145)

Connecting the smartphone (or computer) to the access point (wireless LAN router)

- Connect the smartphone (or computer) to the access point (wireless LAN router) at home.
- This setting is unnecessary if the smartphone (or computer) has already been connected to the access point (wireless LAN router) at home.

Regular Operation

Monitoring the images by connecting the smartphone and the camera

Operation on this camera

- 1 Tap "MENU".
(Operation on this camera)

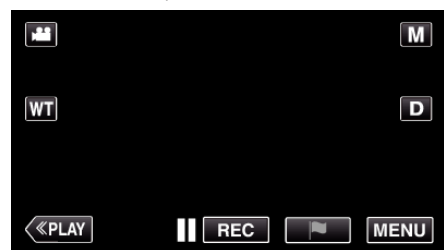

- The top menu appears.

- 2 Tap the "Wi-Fi" icon.
(Operation on this camera)

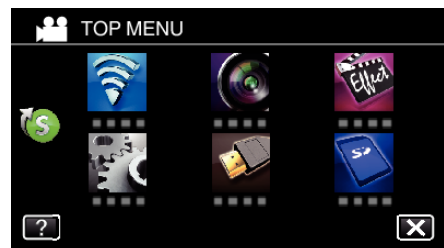

- 3 Tap "INDOOR MONITORING" (house icon).
(Operation on this camera)

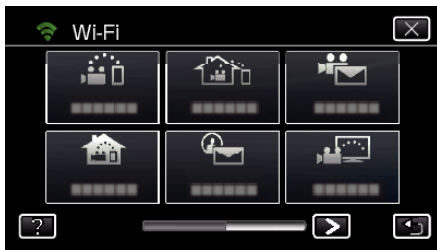

- 4 Tap "START" (→).
(Operation on this camera)

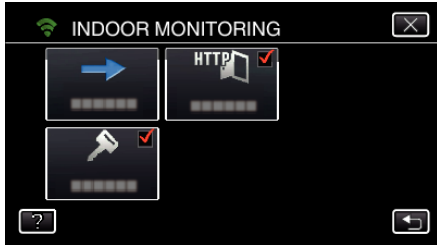

- 5 Start making a connection.
(Operation on this camera)

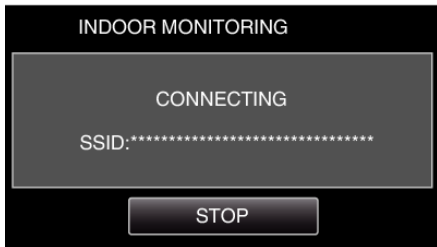

- Name (SSID) of the access point (wireless LAN router) in connection is displayed.

- 6 The following is displayed when the camera is connected to the access point.



- Tap "URL" to display the URL required for connecting the camera from browser.

■ Operation on the smartphone

Memo : _____
 • Prior to use this function, a smartphone application needs to be installed on the smartphone.
 "Installing Smartphone Applications" (☞ p. 156)

- 1 Start "Everio sync. 2" on the smartphone after setting "INDOOR MONITORING".



- Tap "START" in INDOOR MONITORING on the camera to start.

- 2 Tap "INDOOR MONITORING".



- 3 The recording screen is displayed.

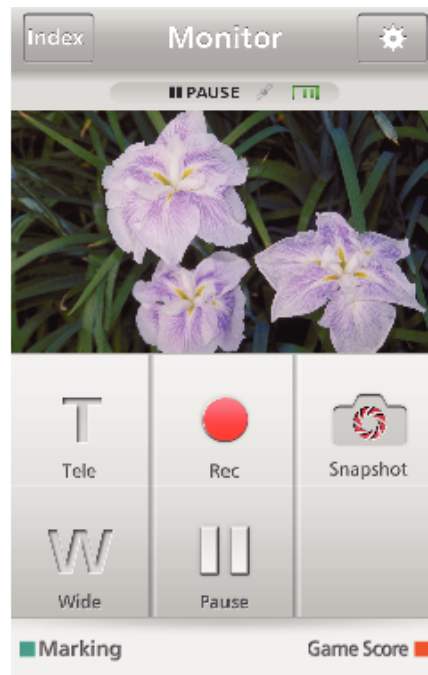

- How to operate from a smartphone
 "Using Smartphone Applications" (☞ p. 156)

■ Monitoring from the computer (Windows7)

- 1 Tap the URL button shown on the camera's screen.
 (displayed when the computer and the camera are connected wirelessly.)



- The URL for the computer to connect to appears.

- 2 Check the URL being displayed on the camera screen, which starts from "http://".



- After checking the URL, tap “QUIT” to return to the previous screen.

- 3 Start Internet Explorer (web browser) on the computer and enter the URL.

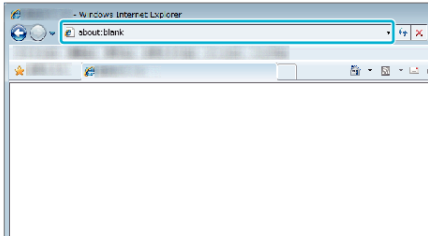

- 4 Log in with your username and password.
 - The username is “everio” and the default password is “0000”.
 “Changing the Settings” (☞ p. 134)
 - Operations from the Web browser
 “Using the Wi-Fi Function from a Web Browser” (☞ p. 169)

OUTDOOR MONITORING

- **Setting (Once setting is done, start from the “Regular Operation” below)**

Obtaining a Dynamic DNS Account

By obtaining a dynamic DNS account, this unit may be used on the web as usual even if the IP address changes when making an access to this unit via internet.

- Only the JVC dynamic DNS service can be set on this camera.

To obtain (register) an account, perform the following steps.

- 1 Access the following URL from a browser and register for an account. (Operation on a computer or smartphone)
<https://dd3.jvckenwood.com/user/>
 Set your e-mail address as the username.
- 2 Check that you have received a confirmation e-mail to the address used in registration, and access the URL stated in the e-mail. (Operation on a computer or smartphone)
- 3 Set the username and password used in registration on the camera. (Operation on this camera)
 “Setting Dynamic DNS on this Camera (OUTDOOR MONITORING)”
 (☞ p. 139)
- 4 Execute OUTDOOR MONITORING. (Operation on this camera)
 If “OUTDOOR MONITORING” is executed while dynamic DNS settings are enabled, the camera will access the dynamic DNS server.
- 5 Tap “CAMERA NETWORK INFO.” to check that the URL (WAN) is displayed. (Registration complete)
 “Image Monitoring via the Internet (OUTDOOR MONITORING)”
 (☞ p. 120)

Caution :

- Registration will be canceled if you do not access the dynamic DNS server from the camera within 3 days.
 Perform the registration again in this case.
- Registration will not be complete if the username and password set on this camera are incorrect. Be sure to check that they are correct.
- Successful registration will be canceled too if you do not access the dynamic DNS server for 1 year.

Create a QR code.

- **Enter values in the required items for outdoor monitoring.**

- Password: set a password to connect this camera to the device via access point. (Not more than 8 characters)
- DDNS: Set the connection environment to the internet. Normally set to “ON”.
- User name (DDNS): set an user name for the obtained DDNS account.
- Password (DDNS): set a password for the obtained DDNS account.
- UPnP: Set to “ON” if the UPnP protocol may be used to connect the device to the network.
- HTTP Port: Set the port number for connecting to the internet. Normally set to “80”.

Display the screen for reading the QR code.

- 1 Tap “MENU”.
- (Operation on this camera)

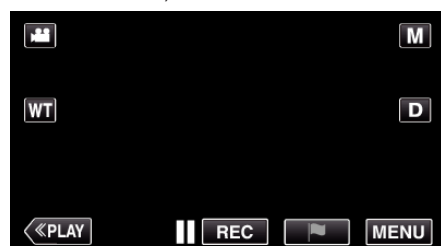

- The top menu appears.

- 2 Tap the "Wi-Fi" (📶) icon.
(Operation on this camera)

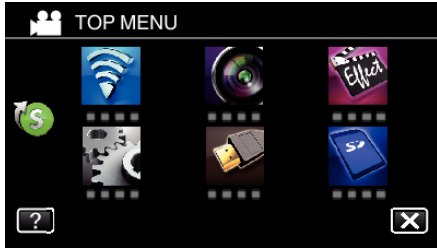

- 3 Tap > on the lower right of the screen.
(Operation on this camera)



- 4 Tap "COMMON Wi-Fi SETTING".
(Operation on this camera)

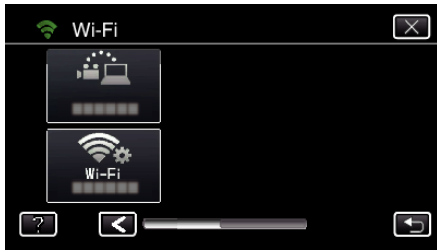

- 5 Tap "SET FROM QR CODE".

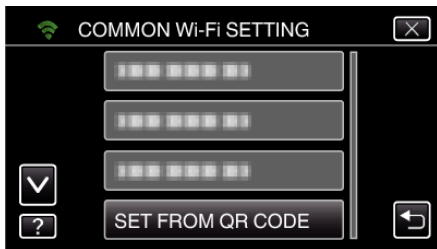

- 6 Tap "EXECUTE".



Read a QR code.

- 1 Read a QR code.
(Operation on this camera)

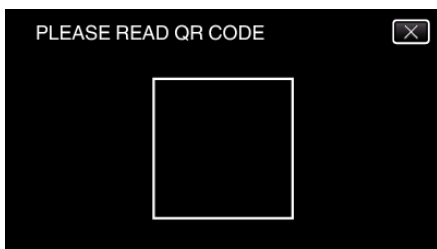

- 2 Tap "YES".



- 3 Tap "OK".

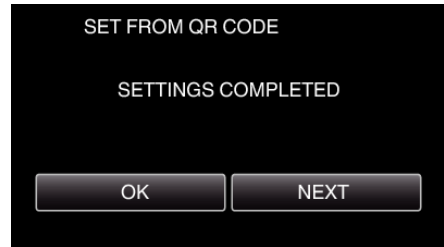

- Tap "NEXT" to return to the screen to read the QR code.
- Set contents are saved.

Registering the access points (wireless LAN router) to this unit

■ Wi-Fi Protected Setup (WPS) Registration

- 1 Tap "MENU".
(Operation on this camera)



- The top menu appears.

- 2 Tap the "Wi-Fi" (📶) icon.
(Operation on this camera)

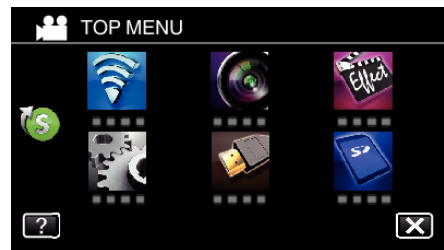

- 3 Tap > on the lower right of the screen.
(Operation on this camera)

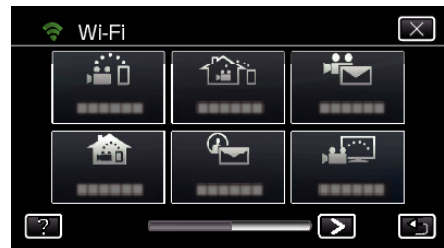

- 4 Tap "COMMON Wi-Fi SETTING".
(Operation on this camera)



- 5 Tap "ACCESS POINTS".
(Operation on this camera)

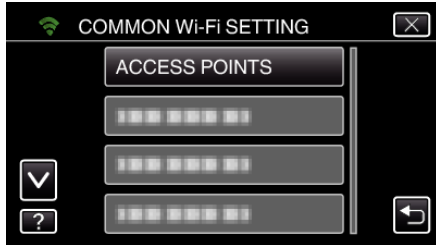

- 6 Tap "ADD".
(Operation on this camera)



- 7 Tap "EZ REGISTRATION WPS".
(Operation on this camera)

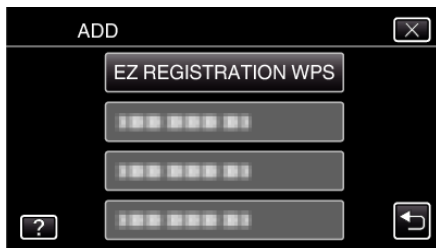

- 8 Activate WPS of the access point (wireless LAN router) within 2 minutes.
 - To activate WPS, refer to the instruction manual of the device in use.
- 9 After registration is complete, tap "OK" on the camera's screen.
(Operation on this camera)



■ Search the access point, and select from the list.

Set the name (SSID) of the access point (wireless LAN router) and the password beforehand.

- 1 Tap "MENU".
(Operation on this camera)



- The top menu appears.
- 2 Tap the "Wi-Fi" (Wi-Fi icon).
(Operation on this camera)

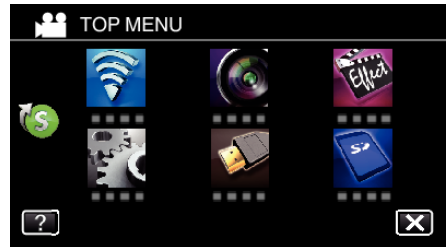

- 3 Tap > on the lower right of the screen.
(Operation on this camera)

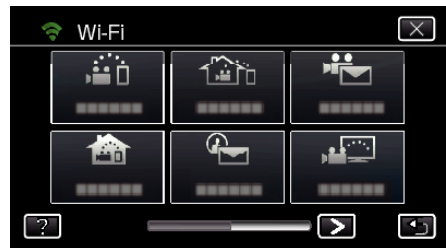

- 4 Tap "COMMON Wi-Fi SETTING".
(Operation on this camera)



- 5 Tap "ACCESS POINTS".
(Operation on this camera)

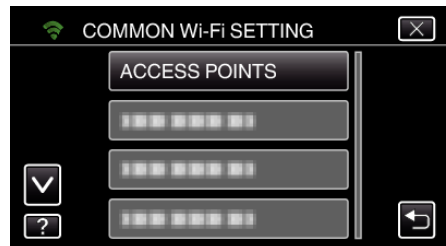

- 6 Tap "ADD".
(Operation on this camera)



- 7 Tap "SEARCH".
(Operation on this camera)

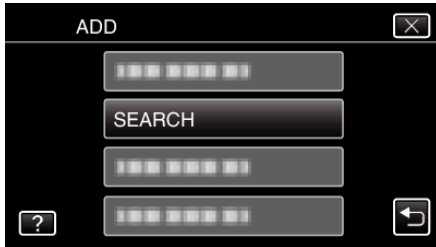

- The search results appear on the camera's screen.

- 8 Tap the name (SSID) of the desired access point from the list of search results.
(Operation on this camera)

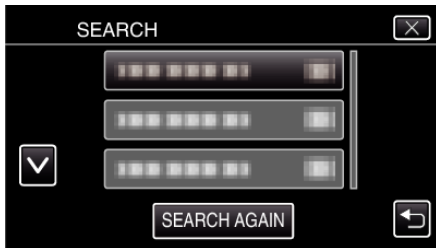

- 9 Register a password.
(Operation on this camera)



- Tap on the on-screen keyboard to enter characters. The character changes with every tap. "ABC", for example, enter "A" by tapping once, "B" by tapping twice, or "C" by tapping 3 times.
- Tap "DELETE" to delete a character.
- Tap "CANCEL" to exit.
- Tap "A/a/1" to select character input type from upper case letter, lower case letter, and number.
- Tap ← or → to move one space to the left or right.
- The password is not required if the wireless LAN router is not security protected.

- 10 After registration is complete, tap "OK" on the camera's screen.
(Operation on this camera)



- Other methods, such as "Manual Registration" and "WPS PIN Registration" are also available. Refer to the following link for details. "Registering the Access Points of the Camera to Connect (ACCESS POINTS)" (p. 145)

Regular Operation

Connect this camera to a smartphone (or computer).

- 1 Tap "MENU".
(Operation on this camera)



- The top menu appears.

- 2 Tap the "Wi-Fi" (Wi-Fi icon).
(Operation on this camera)

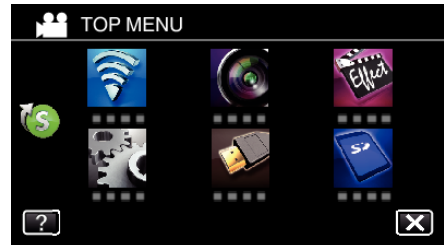

- 3 Tap "OUTDOOR MONITORING" (house with Wi-Fi icon).
(Operation on this camera)



- 4 Tap "START" (right arrow icon).
(Operation on this camera)

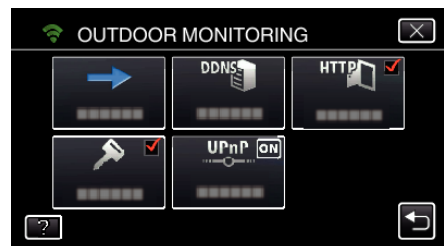

- 5 Start making a connection.
(Operation on this camera)



- Name (SSID) of the access point (wireless LAN router) in connection is displayed.

- 6 The following is displayed when the camera is connected to the access point.



- The URL (WAN) for the smartphone to connect to appears.

(Does not appear if DDNS is not set or set incorrectly.)

- “XUPnP” is displayed when UPnP cannot be used.

7 Check the URL (WAN).



- After checking the URL, tap “QUIT” to return to the previous screen.
- “XUPnP” is displayed when UPnP cannot be used.

Operation on the smartphone

Memo :

- Prior to use this function, a smartphone application needs to be installed on the smartphone.

“Installing Smartphone Applications” (p. 156)

1 Start “Everio sync. 2” on the smartphone after setting OUTDOOR MONITORING.



- Tap “START” in OUTDOOR MONITORING on the camera to start.

2 Tap “OUTDOOR MONITORING”.



3 Log in with your username and password.
(if authentication cannot be achieved)

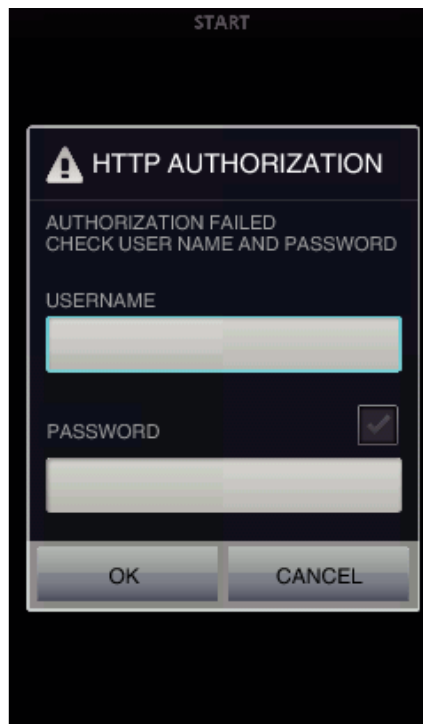

- The username is “everio” and the default password is “0000”.
“Changing the Settings” (p. 134)

4 The recording screen is displayed.

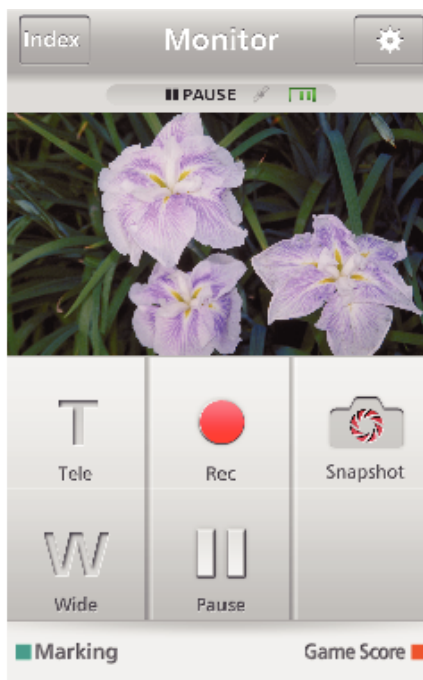

5 Operate from a smartphone



- How to operate from a smartphone
“Using Smartphone Applications” (p. 156)

■ Monitoring from the computer (Windows7)

- 1 On the Internet Explorer (web browser), enter the URL (WAN) that is checked by "Operation on this camera".

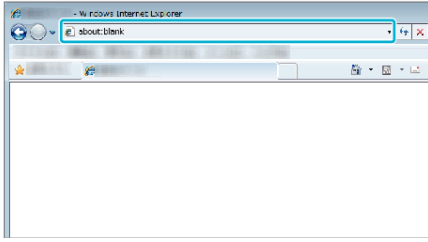

- 2 Log in with your username and password.
 - The username is "everio" and the default password is "0000".
 - "Changing the Settings" (E p. 134)
 - Operations from the Web browser

DETECT/MAIL

■ Setting (Once setting is done, start from the "Regular Operation" below)

Create a QR code.

Memo :

- Perform operations in step 2 and 3 after creating a QR code, and read the QR code one by one by the camera.

■ Enter values in the required items for setting the recipient's e-mail address.

- E-mail address: set the recipient's e-mail address.
- E-mail function: set the function of the e-mail that is transmitted to the recipient's e-mail address.
- Up to 8 e-mail addresses can be set.
- Start reading from (1) if multiple e-mail addresses are set. Click the number or "<", ">".

■ Enter values in the required items for setting the sender's e-mail address.

- E-mail address: set the sender's e-mail address.

■ Enter values in the required items for setting the e-mail server (SMTP server).

- SMTP server: set the name of the e-mail server (SMTP server) from which an e-mail account is obtained.
- SMTP port number: set according to the condition when the e-mail account is obtained. Normally set to "25".
- SMTP authentication method: set according to the condition when the e-mail account is obtained.
- User name: set if the SMTP authentication method is set to other than "None". (same as the registered user name (account name) when the e-mail account is obtained)
- Password: set if the SMTP authentication method is set to other than "None". (same as the registered password when the e-mail account is obtained)

■ Enter values in the required items for setting notification mails.

- Detection method: set the detection method of when to start recording video for notification e-mails.
- Detecting interval: select the time period to enable detection again after the previous one.
- Self recording: specify whether to save the detected video on the camera (ON) or not (OFF).

Display the screen for reading the QR code.

- 1 Tap "MENU".
(Operation on this camera)



- The top menu appears.
- 2 Tap the "Wi-Fi" (Wi-Fi icon).
(Operation on this camera)

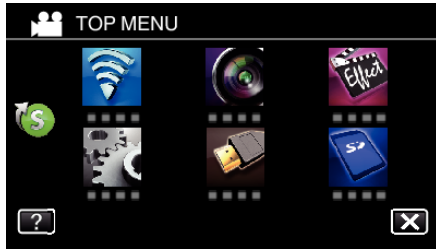

- Tap > on the lower right of the screen.
(Operation on this camera)



- Tap "COMMON Wi-Fi SETTING".
(Operation on this camera)

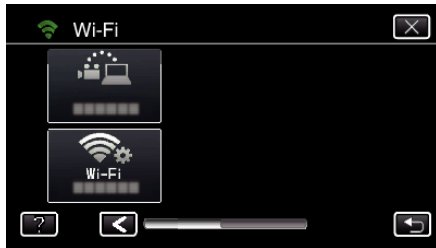

- Tap "SET FROM QR CODE".



- Tap "EXECUTE".



Read a QR code.

- Read a QR code.
(Operation on this camera)

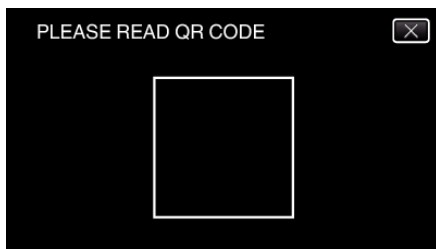

- Tap "YES".

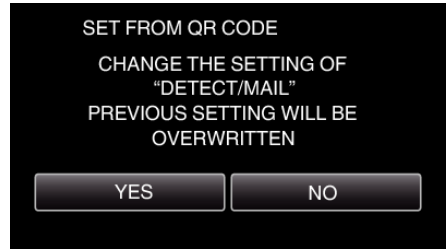

- Contents of the screen vary depending on the QR code that is read by this unit.

- Tap "OK".

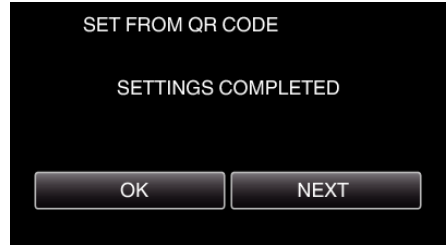

- Tap "NEXT" to return to the screen to read the QR code.
- Set contents are saved.

Registering the access points (wireless LAN router) to this unit

■ Wi-Fi Protected Setup (WPS) Registration

- Tap "MENU".
(Operation on this camera)

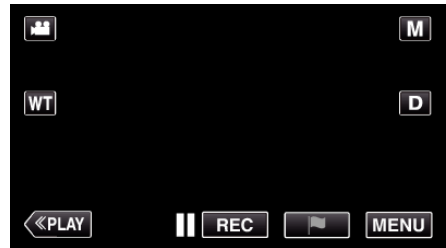

- The top menu appears.

- Tap the "Wi-Fi" (Wi-Fi icon).
(Operation on this camera)

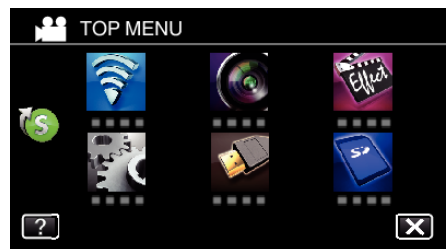

- Tap > on the lower right of the screen.
(Operation on this camera)

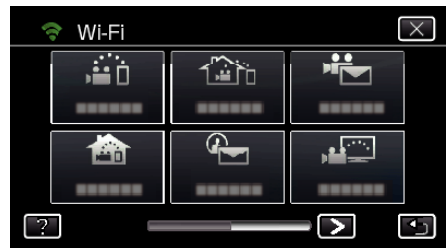

- Tap "COMMON Wi-Fi SETTING".
(Operation on this camera)

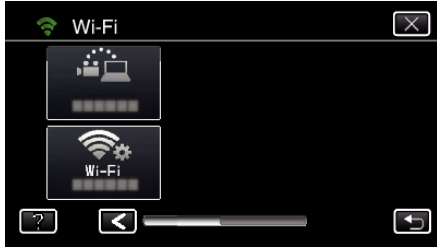

- 5 Tap "ACCESS POINTS".
(Operation on this camera)



- 6 Tap "ADD".
(Operation on this camera)



- 7 Tap "EZ REGISTRATION WPS".
(Operation on this camera)

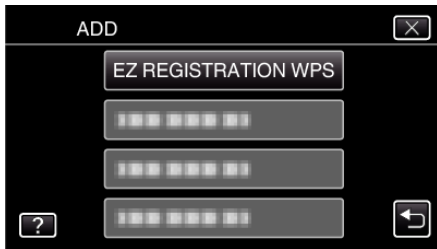

- 8 Activate WPS of the access point (wireless LAN router) within 2 minutes.
 - To activate WPS, refer to the instruction manual of the device in use.

- 9 After registration is complete, tap "OK" on the camera's screen.
(Operation on this camera)



■ Search the access point, and select from the list.

Set the name (SSID) of the access point (wireless LAN router) and the password beforehand.

- 1 Tap "MENU".
(Operation on this camera)



- The top menu appears.

- 2 Tap the "Wi-Fi" (Wi-Fi icon).
(Operation on this camera)

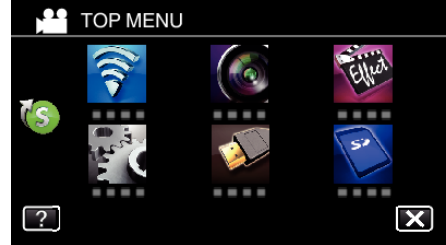

- 3 Tap > on the lower right of the screen.
(Operation on this camera)



- 4 Tap "COMMON Wi-Fi SETTING".
(Operation on this camera)

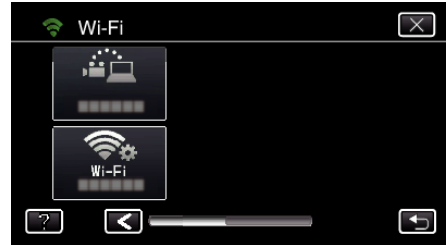

- 5 Tap "ACCESS POINTS".
(Operation on this camera)

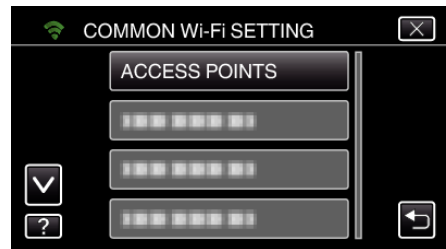

- 6 Tap "ADD".
(Operation on this camera)



- 7 Tap "SEARCH".
(Operation on this camera)

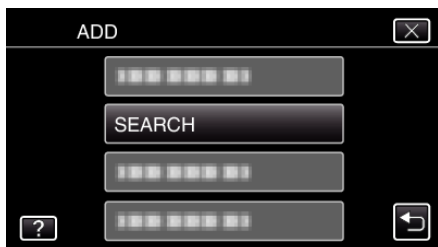

- The search results appear on the camera's screen.

8 Tap the name (SSID) of the desired access point from the list of search results.
(Operation on this camera)

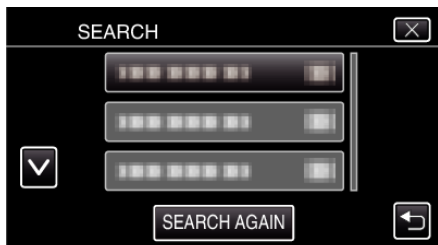

9 Register a password.
(Operation on this camera)



- Tap on the on-screen keyboard to enter characters. The character changes with every tap. "ABC", for example, enter "A" by tapping once, "B" by tapping twice, or "C" by tapping 3 times.
- Tap "DELETE" to delete a character.
- Tap "CANCEL" to exit.
- Tap "A/a/1" to select character input type from upper case letter, lower case letter, and number.
- Tap ← or → to move one space to the left or right.
- The password is not required if the wireless LAN router is not security protected.

10 After registration is complete, tap "OK" on the camera's screen.
(Operation on this camera)



- Other methods, such as "Manual Registration" and "WPS PIN Registration" are also available. Refer to the following link for details. "Registering the Access Points of the Camera to Connect (ACCESS POINTS)" (p. 145)

■ Regular Operation

Sending a Notification Mail.

1 Tap "MENU".
Set the camera to the recording mode.

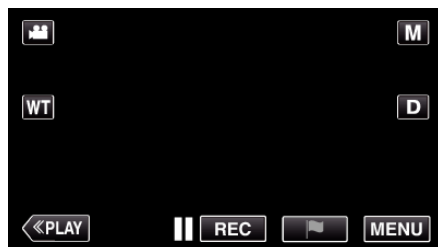

- The top menu appears.

2 Tap the "Wi-Fi" (Wi-Fi) icon.

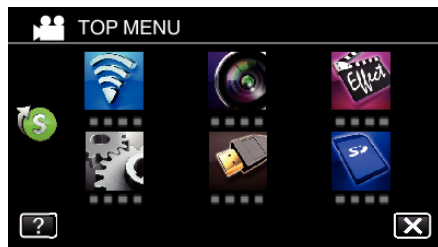

3 Tap "DETECT/MAIL" (DETECT/MAIL).



4 Tap "DETECT/MAIL ATTN.".



5 Select "DETECT/MAIL ATTN.", then tap ↩.

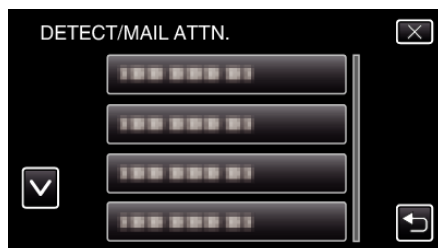

- To display the ↩ icon, tap the e-mail address.
- To cancel the e-mail address, press the icon one more time.
- Up to 8 e-mail addresses can be selected.

6 Tap "START" (START).

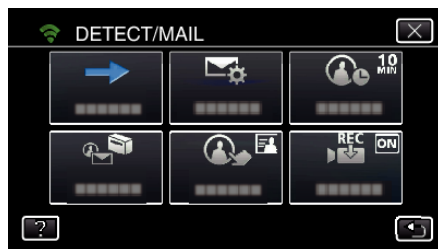

7 Start making a connection.

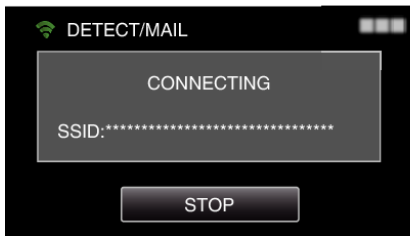

8 DETECT/MAIL detection standby



- Detection is suspended for the first 5 seconds.

9 DETECT/MAIL detection in progress (an e-mail is automatically sent out after detection is completed)



- The "PHOTO" icon appears on the screen for about 2 seconds upon detection.
- Images are captured automatically when moving subjects or human faces appear on the camera's screen. (The PHOTO icon appears on the screen upon detection.)
- The captured still images will be sent via e-mail to the selected recipients.

10 Detection suspended



- Until the next detection is made, detection is suspended for the pre-set length of time.
 - "DETECTION INTERVAL" can be selected from 15 seconds, 1 minute, 3 minutes, 10 minutes, 30 minutes and 60 minutes.
- "Setting the Detection Interval of this Camera (DETECT/MAIL SETTING)" (p. 144)

Check the incoming e-mail.

VIDEO MAIL

■ Setting (Once setting is done, start from the "Regular Operation" below)

Create a QR code.

Memo :

- Perform operations in step 2 and 3 after creating a QR code, and read the QR code one by one by the camera.

■ Enter values in the required items for setting the recipient's e-mail address.

- E-mail address: set the recipient's e-mail address.
- E-mail function: set the function of the e-mail that is transmitted to the recipient's e-mail address.
- Up to 8 e-mail addresses can be set.
- Start reading from (1) if multiple e-mail addresses are set. Click the number or "<", ">".

■ Enter values in the required items for setting the sender's e-mail address.

- E-mail address: set the sender's e-mail address.

■ Enter values in the required items for setting the e-mail server (SMTP server).

- SMTP server: set the name of the e-mail server (SMTP server) from which an e-mail account is obtained.
- SMTP port number: set according to the condition when the e-mail account is obtained. Normally set to "25".
- SMTP authentication method: set according to the condition when the e-mail account is obtained.
- User name: set if the SMTP authentication method is set to other than "None". (same as the registered user name (account name) when the e-mail account is obtained)
- Password: set if the SMTP authentication method is set to other than "None". (same as the registered password when the e-mail account is obtained)

Display the screen for reading the QR code.

1 Tap "MENU".
(Operation on this camera)

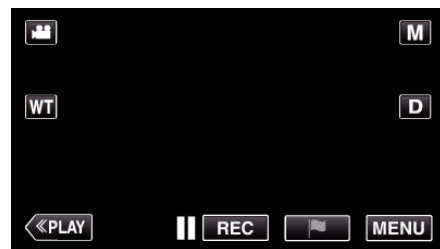

- The top menu appears.

2 Tap the "Wi-Fi" (Wi-Fi icon).
(Operation on this camera)

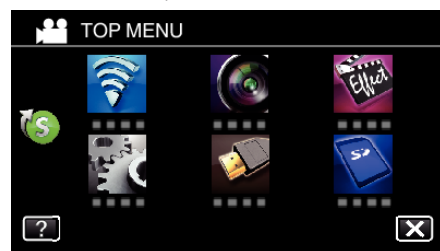

3 Tap > on the lower right of the screen.
(Operation on this camera)

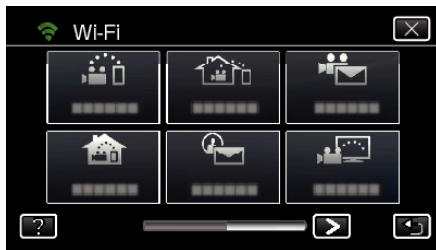

- 4 Tap "COMMON Wi-Fi SETTING".
(Operation on this camera)

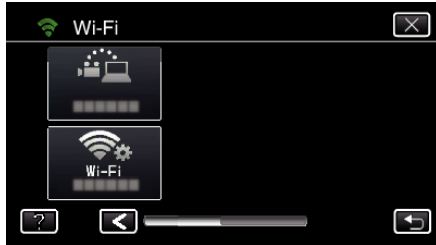

- 5 Tap "SET FROM QR CODE".

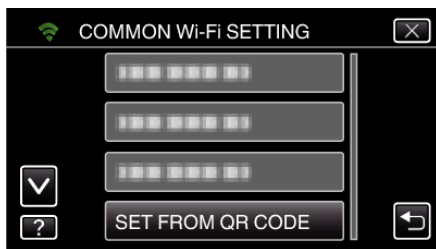

- 6 Tap "EXECUTE".

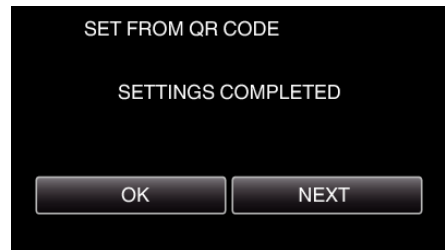

- Tap "NEXT" to return to the screen to read the QR code.
- Set contents are saved.

Registering the access points (wireless LAN router) to this unit

■ Wi-Fi Protected Setup (WPS) Registration

- 1 Tap "MENU".
(Operation on this camera)

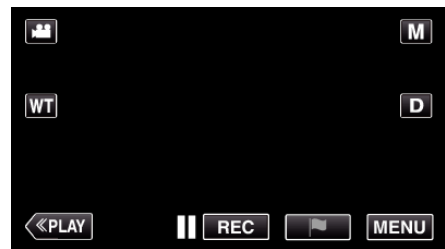

- The top menu appears.

- 2 Tap the "Wi-Fi" (Wi-Fi icon).
(Operation on this camera)

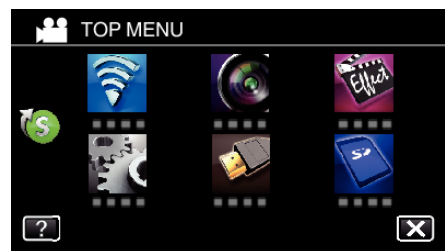

- 3 Tap > on the lower right of the screen.
(Operation on this camera)



- 4 Tap "COMMON Wi-Fi SETTING".
(Operation on this camera)



- 5 Tap "ACCESS POINTS".
(Operation on this camera)

Read a QR code.

- 1 Read a QR code.
(Operation on this camera)

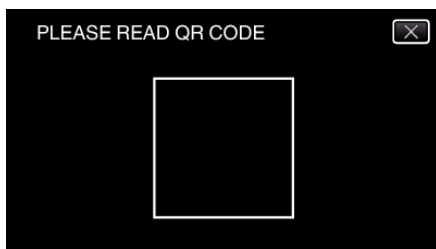

- 2 Tap "YES".

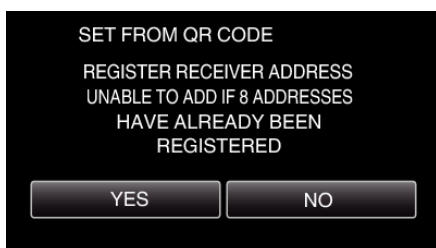

- Contents of the screen vary depending on the QR code that is read by this unit.

- 3 Tap "OK".

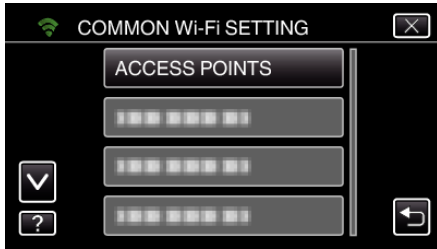

- 6 Tap "ADD".
(Operation on this camera)

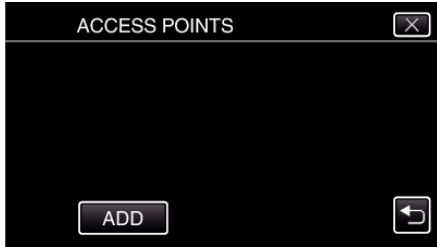

- 7 Tap "EZ REGISTRATION WPS".
(Operation on this camera)

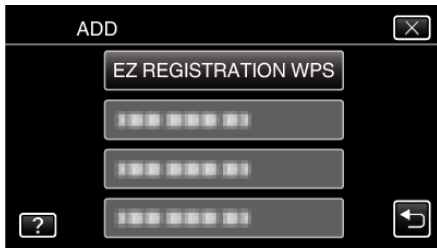

- 8 Activate WPS of the access point (wireless LAN router) within 2 minutes.
• To activate WPS, refer to the instruction manual of the device in use.
- 9 After registration is complete, tap "OK" on the camera's screen.
(Operation on this camera)



■ Search the access point, and select from the list.

Set the name (SSID) of the access point (wireless LAN router) and the password beforehand.

- 1 Tap "MENU".
(Operation on this camera)



- The top menu appears.
- 2 Tap the "Wi-Fi" (Wi-Fi icon).
(Operation on this camera)

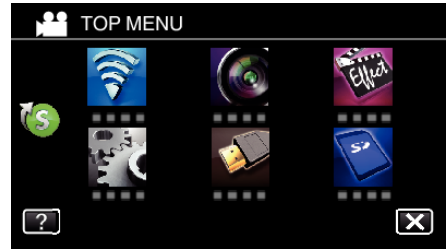

- 3 Tap > on the lower right of the screen.
(Operation on this camera)



- 4 Tap "COMMON Wi-Fi SETTING".
(Operation on this camera)



- 5 Tap "ACCESS POINTS".
(Operation on this camera)

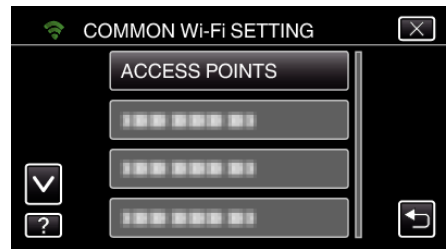

- 6 Tap "ADD".
(Operation on this camera)



- 7 Tap "SEARCH".
(Operation on this camera)

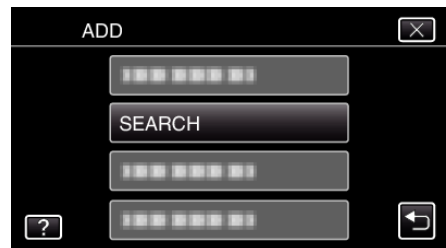

- The search results appear on the camera's screen.
- 8 Tap the name (SSID) of the desired access point from the list of search results.
(Operation on this camera)

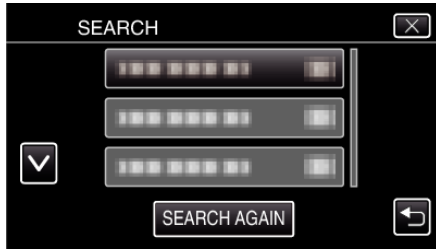

9 Register a password.
(Operation on this camera)

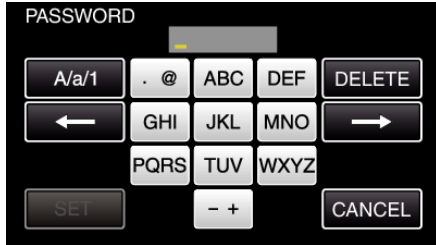

- Tap on the on-screen keyboard to enter characters. The character changes with every tap. "ABC", for example, enter "A" by tapping once, "B" by tapping twice, or "C" by tapping 3 times.
- Tap "DELETE" to delete a character.
- Tap "CANCEL" to exit.
- Tap "A/a/1" to select character input type from upper case letter, lower case letter, and number.
- Tap ← or → to move one space to the left or right.
- The password is not required if the wireless LAN router is not security protected.

10 After registration is complete, tap "OK" on the camera's screen.
(Operation on this camera)



- Other methods, such as "Manual Registration" and "WPS PIN Registration" are also available. Refer to the following link for details. "Registering the Access Points of the Camera to Connect (ACCESS POINTS)" (p. 145)

■ Regular Operation

Record videos to send a video mail.

1 Tap "MENU".
Set the camera to the recording mode.

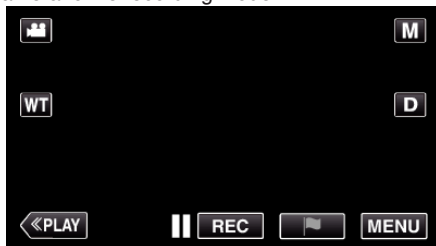

- The top menu appears.

2 Tap the "Wi-Fi" (Wi-Fi icon) icon.

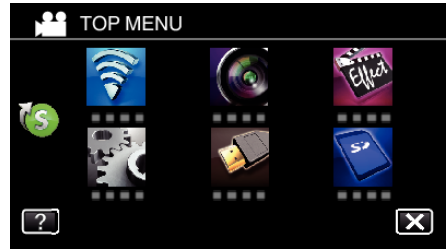

3 Tap "VIDEO MAIL" (video mail icon).

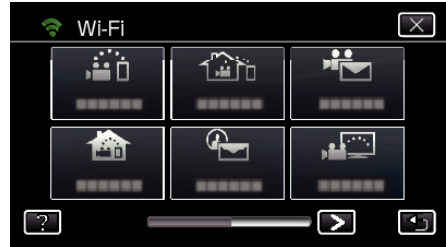

4 Tap "VIDEO MAIL ADDRESS".

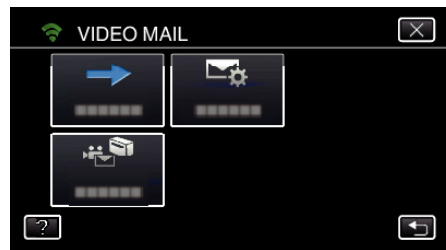

5 Select "VIDEO MAIL ADDRESS", then tap ↻.

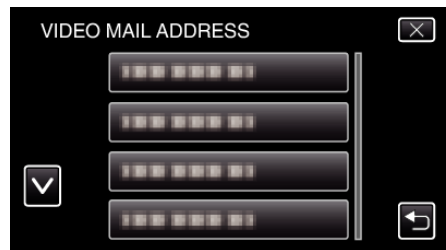

- To display the e-mail icon, tap the e-mail address.
- To cancel the e-mail address, press the icon one more time.
- Up to 8 e-mail addresses can be selected.

6 Tap "START" (START/STOP icon).

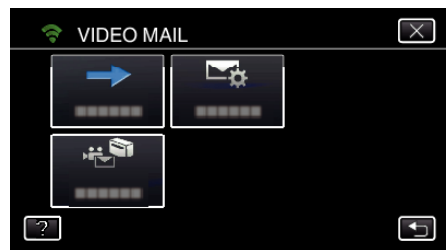

7 Press the START/STOP button to start recording.

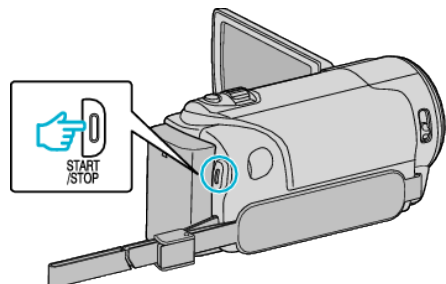

- Or, tap the REC on screen.

8 Recording starts after the 5-second countdown.



- You can allow the recording to be performed for 15 seconds or press the START/STOP button to stop.

9 Tap "SEND".



- Sending of the video mail starts.
- To check the file, tap "PLAY TO CHECK".
- When it is complete, tap "OK".

Check the incoming e-mail.

TV MONITORING

■ **Setting (Once setting is done, start from the "Regular Operation" below)**

Create a QR code.

■ **Enter values in the required items for the TV monitor.**

- MAC address filter: set to "ON" if monitoring images with a specific TV device.
- Add the MAC address: register the physical address when monitoring images with a specific TV device. (Up to 8 addresses can be registered)

Display the screen for reading the QR code.

1 Tap "MENU".
(Operation on this camera)



- The top menu appears.

2 Tap the "Wi-Fi" (Wi-Fi icon).
(Operation on this camera)

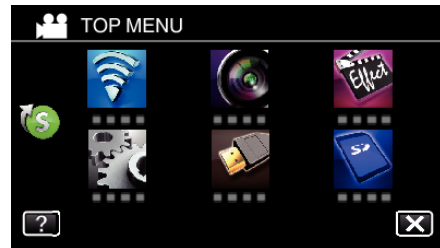

3 Tap > on the lower right of the screen.
(Operation on this camera)



4 Tap "COMMON Wi-Fi SETTING".
(Operation on this camera)

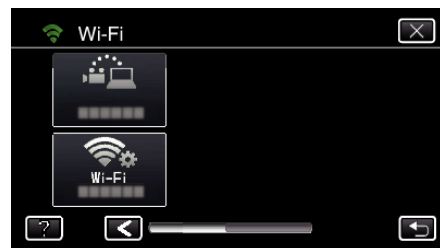

5 Tap "SET FROM QR CODE".



6 Tap "EXECUTE".



Read a QR code.

1 Read a QR code.
(Operation on this camera)

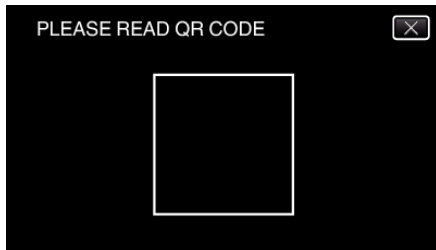

2 Tap "YES".

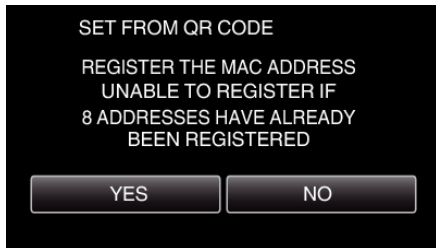

3 Tap "OK".

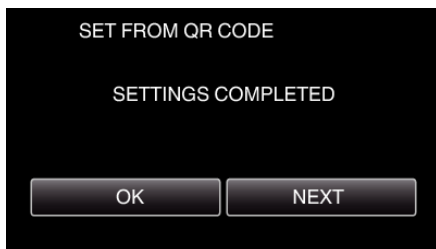

- Tap "NEXT" to return to the screen to read the QR code.
- Set contents are saved.

Registering the access points (wireless LAN router) to this unit

■ Wi-Fi Protected Setup (WPS) Registration

1 Tap "MENU".
(Operation on this camera)



- The top menu appears.

2 Tap the "Wi-Fi" (Wi-Fi icon).
(Operation on this camera)

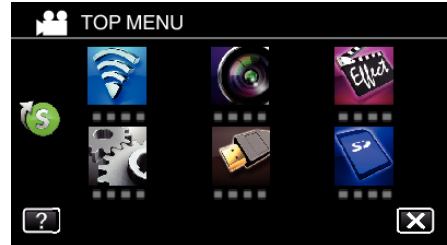

3 Tap > on the lower right of the screen.
(Operation on this camera)



4 Tap "COMMON Wi-Fi SETTING".
(Operation on this camera)



5 Tap "ACCESS POINTS".
(Operation on this camera)

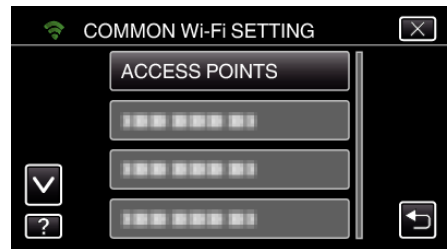

6 Tap "ADD".
(Operation on this camera)



7 Tap "EZ REGISTRATION WPS".
(Operation on this camera)

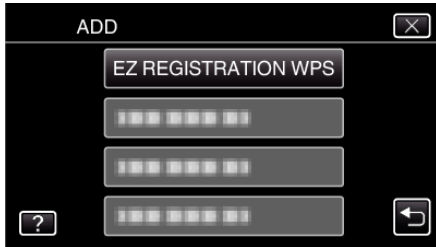

- 8 Activate WPS of the access point (wireless LAN router) within 2 minutes.
 - To activate WPS, refer to the instruction manual of the device in use.
- 9 After registration is complete, tap "OK" on the camera's screen. (Operation on this camera)



■ Search the access point, and select from the list.

Set the name (SSID) of the access point (wireless LAN router) and the password beforehand.

- 1 Tap "MENU". (Operation on this camera)

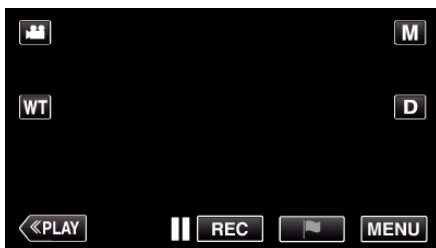

- The top menu appears.

- 2 Tap the "Wi-Fi" (Wi-Fi icon) icon. (Operation on this camera)

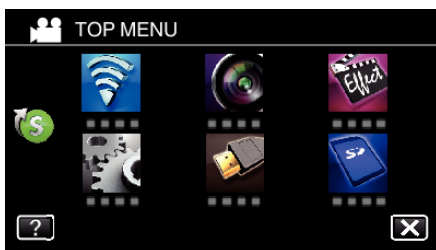

- 3 Tap > on the lower right of the screen. (Operation on this camera)



- 4 Tap "COMMON Wi-Fi SETTING". (Operation on this camera)

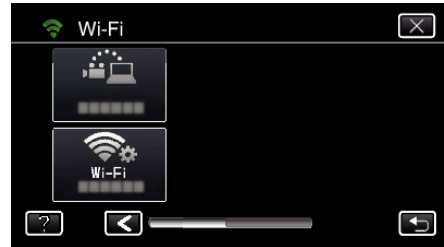

- 5 Tap "ACCESS POINTS". (Operation on this camera)

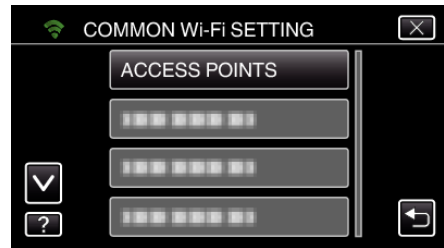

- 6 Tap "ADD". (Operation on this camera)



- 7 Tap "SEARCH". (Operation on this camera)

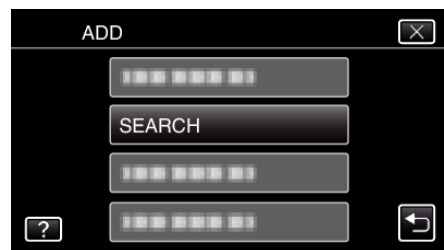

- The search results appear on the camera's screen.

- 8 Tap the name (SSID) of the desired access point from the list of search results. (Operation on this camera)

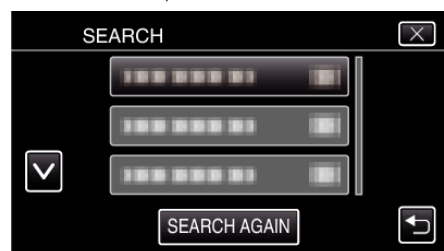

- 9 Register a password. (Operation on this camera)



- Tap on the on-screen keyboard to enter characters. The character changes with every tap.

“ABC”, for example, enter “A” by tapping once, “B” by tapping twice, or “C” by tapping 3 times.

- Tap “DELETE” to delete a character.
- Tap “CANCEL” to exit.
- Tap “A/a/1” to select character input type from upper case letter, lower case letter, and number.
- Tap ← or → to move one space to the left or right.
- The password is not required if the wireless LAN router is not security protected.

10 After registration is complete, tap “OK” on the camera’s screen.
(Operation on this camera)



- Other methods, such as “Manual Registration” and “WPS PIN Registration” are also available. Refer to the following link for details. “Registering the Access Points of the Camera to Connect (ACCESS POINTS)” (p. 145)

■ Regular Operation

Connect the TV to the access point.

- Connect the DLNA compatible TV to the access point (this function is available for a connection via cables as well)
- For details on connecting your TV to a Wi-Fi network, please refer to the instruction manual of the TV in use.

Connecting This Camera to the TV

1 Tap “MENU”.
(Operation on this camera)

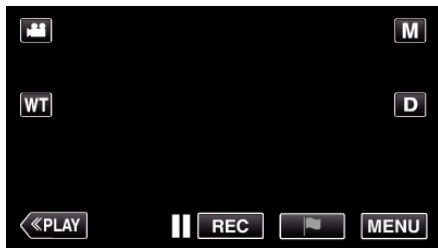

- The top menu appears.

2 Tap the “Wi-Fi” (Wi-Fi icon).
(Operation on this camera)

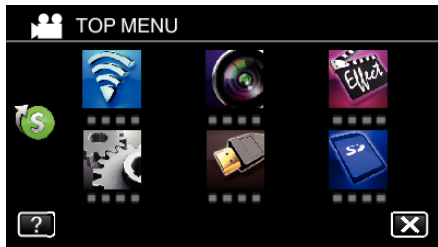

3 Tap “TV MONITORING” (TV icon).
(Operation on this camera)



4 Tap “START” (→).
(Operation on this camera)

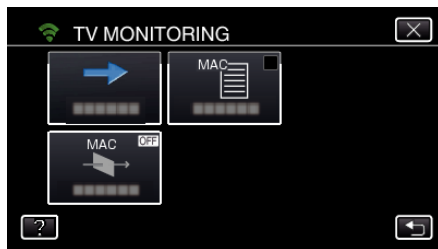

5 Start making a connection.
(Operation on this camera)

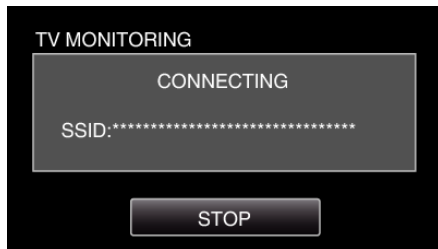

6 Connection in progress



7 After the connection is completed, wait for the DLNA device to start up.
(Operation on this camera)

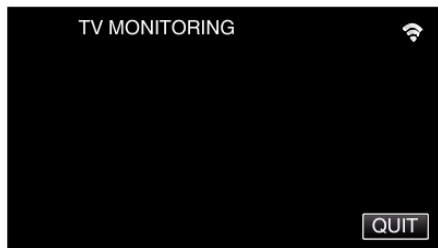

- If a considerable number of videos/still images are recorded in the camera, it may take some time to start.

8 Images appear on the monitor of the DLNA device
(Operation on DLNA device)



- From the following instructions, perform operations on the DLNA device. For details on using the TV, refer to the instruction manual of the TV in use.

Memo :

- If no image is displayed during TV monitoring, tap “STOP” to start from step 1.
- If the DLNA compatible TV in use cannot detect Everio, tap “STOP” to start from the step 1 again.

Operating the Menu

There are two types of menus in this unit.

- TOP MENU: Menu that contains all the items specific to the video recording, still image recording, video playback, and still image playback modes respectively.
- SHORTCUT MENU: Menu that contains the recommended functions for video/still image recording.

Operating the Top Menu

You can configure various settings using the menu.

*The following is a screen of the model with Wi-Fi functions.

- 1 Tap "MENU".



- The top menu appears.
- The menu differs according to the mode in use.

- 2 Tap the desired menu.

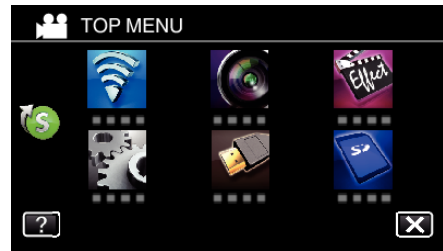

- 3 Tap the desired setting.

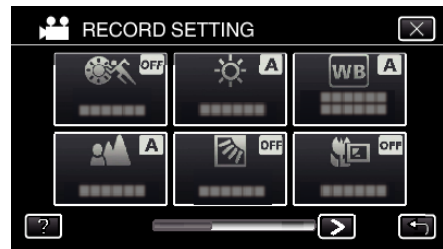

Memo :

- To display the previous/next menu
Tap < or >.
- To exit the screen
Tap X (quit).
- To display the help file
Tap ? (help) and tap the item.
Help file may not be available for some items.

Operating the Shortcut Menu



You can configure various settings of the recommended functions in the video/still image recording mode using the shortcut menu.

*The following is a screen of the model with Wi-Fi functions.

- 1 Tap "MENU".



- 2 Tap the shortcut icon (S).

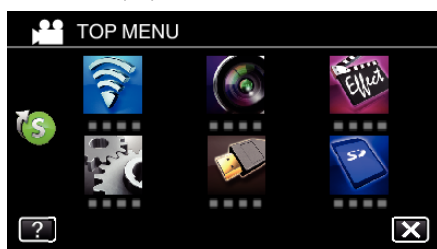

- The shortcut menu appears.

- 3 Tap the desired menu and setting.

<Shortcut Menu During Video Recording Mode>



- Allows settings of "EASY STORAGE", "ANIMATION EFFECT", "DECORATE FACE EFFECT", "SMILE SHOT", "SMILE%/NAME DISPLAY" and "BACKLIGHT COMP. (manual mode only)".

<Shortcut Menu During Still Image Recording Mode>

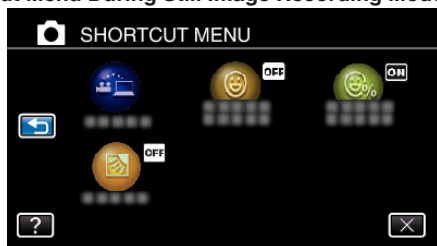

- Allows settings of "EASY STORAGE", "SMILE SHOT", "SMILE%/NAME DISPLAY" and "BACKLIGHT COMP. (manual mode only)".

Memo :

- To return to the top menu

Tap ↵ (return).

- To exit the screen

Tap × (quit).

- To display the help file

Tap ? (help) and tap the item.

RECORD SETTING Menu (video)



SCENE SELECT

Settings to suit the shooting condition can be selected.

“Shooting According to Scene (Subject)” (☞ p. 34)

*Displayed only in the manual recording mode.

FOCUS

Focus can be adjusted manually.

“Adjusting Focus Manually” (☞ p. 35)

*Displayed only in the manual recording mode.

BRIGHTNESS ADJUST

Adjusts the overall brightness of the screen.

“Adjusting Brightness” (☞ p. 36)

*Displayed only in the manual recording mode.

BACKLIGHT COMP.

Corrects the image when the subject appears dark due to backlight.

“Setting Backlight Compensation” (☞ p. 37)

*Displayed only in the manual recording mode.

WHITE BALANCE

Adjusts the color according to the light source.

“Setting White Balance” (☞ p. 38)

*Displayed only in the manual recording mode.

TELE MACRO

Enables close-up shots when using the telephoto (T) end of the zoom.

“Taking Close-up Shots” (☞ p. 39)

*Displayed only in the manual recording mode.

TOUCH PRIORITY AE/AF

Automatically adjusts focus and brightness based on the subjects' faces or selected area.

“Capturing Subjects Clearly (TOUCH PRIORITY AE/AF)” (☞ p. 46)

LIGHT

Turns on/off the light.

Setting	Details
OFF	Does not light up.
AUTO	Lights up automatically when the surrounding is dark.
ON	Lights up at all times.

GAIN UP

Makes the subject appear bright automatically when recording in dark places.

Setting	Details
OFF	Deactivates the function.
ON	Electrically brightens the scene when it is dark.
AUTO SLOW-SHUTTER	Slows down the shutter speed to brighten the scene when it is dark.

Memo :

- Although “AUTO SLOW-SHUTTER” brightens the scene more than “ON”, movements of the subject may become unnatural.

WIND CUT

Reduces the noise caused by wind.

Setting	Details
OFF	Deactivates the function.
ON	Activates the function.
AUTO	Activate the function automatically.

SHUTTER MODE

Continuous shooting settings can be adjusted.

Setting	Details
RECORD ONE SHOT	Records one still image.
CONTINUOUS SHOOTING	Records still images continuously while the SNAPSHOT button is pressed.

Memo :

- The size of the still image that is captured in the video mode is 1,920 x 1,080.
- Some SD cards may not support continuous shooting.
- The continuous shooting speed will drop if this function is used repeatedly.

SMILE SHOT

Automatically captures a still image upon detection of a smile.

“Capturing Smiles Automatically (SMILE SHOT)” (p. 47)

SMILE%/NAME DISPLAY

Displays the names and smile levels (%) when faces are detected.

“Setting SMILE%/NAME DISPLAY” (p. 52)

PET SHOT

Automatically captures a still image upon detection of the face of a pet, such as dogs or cats.

“Capturing Pets Automatically (PET SHOT)” (p. 48)

VIDEO REC FORMAT (GZ-EX315)

Select the recording format from “AVCHD”, or “iFrame” which is suitable for importing to “iMovie”.

Setting	Details
AVCHD	Records in AVCHD format.
iFrame	Record in iFrame format, which is suitable for importing to iMovie.

Memo :

- iFrame is a recording format to be handled by the Mac computer. Operation on the Windows PC is not guaranteed.

VIDEO QUALITY

Sets the video quality.

Setting	Details
(if the video recording format is AVCHD)	
UXP	Enables recording in the best picture quality. • Applies to Blu-ray discs only. Videos taken in high-definition quality cannot be saved to DVDs.
XP	Enables recording in high picture quality.
SP	Enables recording in standard quality.
EP	Enables long recordings.
SSW	Enables recording in SD quality.
SEW	Enables recording in SD quality for a long period of time.

Settings Menu

(If the video recording format is iFrame) (GZ-EX315)	
iFrame(1280x720)	Records videos that are suitable for editing in 1280x720 resolution.
iFrame(960x540)	Records videos that are suitable for editing in 960x540 resolution.

Memo :

- Set to “UXP” or “XP” mode when recording fast-moving scenes or scenes with extreme changes of brightness to avoid noise.
- You can change to the desired “VIDEO QUALITY” by tapping on it from the remaining recording time display.

ZOOM

Sets the maximum zoom ratio.

Setting	Details
40x	Enables recording with 1 - 40x optical zoom. Set this when digital zoom is not desired.
60x DYNAMIC (55x DYNAMIC)	Enables recording with 1 - 40x optical zoom and 41 - 60x dynamic zoom, when the image stabilizer is in normal mode or set to off. (Enables recording with 1 - 40x optical zoom and 41 - 55x dynamic zoom, when the image stabilizer is in active mode, or when the camera is set to the iFrame mode*.)
120x DIGITAL (110x DIGITAL)	Enables recording with 1 - 40x optical zoom and 41 - 120x digital zoom, when the camera is set to the AVCHD mode. (Enables recording with 1 - 40x optical zoom and 41 - 110x digital zoom, when the camera is set to the iFrame mode*.)
200x DIGITAL	Enables recording with 1 - 40x optical zoom and 41 - 200x digital zoom.

*GZ-EX315

Memo :

- When digital zoom is used, the image becomes grainy as it is digitally enlarged.
- The angle of view changes when the image stabilizer is turned on or off.

ZOOM MIC

Sets the zoom microphone.

Setting	Details
OFF	Deactivates the zoom microphone.
ON	Records audio sounds in the same direction as the zoom operation.

MIC LEVEL

Make the adjustments such that “MIC LEVEL” does not turn red.

Setting	Details
OFF	Hides display of microphone input level.
ON	Shows display of microphone input level.

MIC LEVEL SETTING

Sets the microphone level.

Make the adjustments such that “MIC LEVEL” does not turn red.

Setting	Details
+2	Increases the microphone input level.
+1	Increases the microphone input level slightly.
0	The microphone input level is not changed.
-1	Decreases the microphone input level slightly.
-2	Decreases the microphone input level.

K2 TECHNOLOGY

Reduces the degradation of sound quality caused by digital signal processing, and records a sound quality close to the original.

Setting	Details
OFF	Deactivates K2 TECHNOLOGY.
ON	Activates K2 TECHNOLOGY.

SPECIAL RECORDING Menu (video)



HIGH SPEED RECORDING

You can record videos in slow-motion by increasing the recording speed to emphasize the movements, and play back the slow-motion video smoothly. This is a handy function for checking movements, such as golf swings.
“Slow-motion (High-speed) Recording” (☞ p. 55)

TIME-LAPSE RECORDING

This function enables the changes of a scene that occur slowly over a long period to be shown within a short time by taking frames of it at a certain interval. This is useful for making observations such as the opening of a flower bud.
“Recording at Intervals (TIME-LAPSE RECORDING)” (☞ p. 56)

STOP-MOTION REC

By pressing the SNAPSHOT button, 2 frames of still images are recorded, and stop-motion videos are created by piecing these images together.
“Recording Stop-Motion Videos (STOP-MOTION REC)” (☞ p. 58)

AUTO REC

Starts recording automatically by sensing the changes in subject’s movement (brightness) within the red frame displayed on the LCD monitor.
“Recording Automatically by Sensing Movements (AUTO REC)” (☞ p. 59)

ANIMATION EFFECT

Records videos with animation effects.
“Recording with Animation Effects (ANIMATION EFFECT)” (☞ p. 41)

DECORATE FACE EFFECT

Detects faces and enables decorations such as crowns or sunglasses to be added.
“Recording with Face Decorations (DECORATE FACE EFFECT)” (☞ p. 43)

STAMP

Records videos with various decorative stamps.
“Recording with Decorative Stamps (STAMP)” (☞ p. 44)

HANDWRITING EFFECT

Records videos with your personal handwriting or drawing.
If the writings and drawings appear to be misaligned, correct the touch position.
“Recording with Personal Handwriting (HANDWRITING EFFECT)” (☞ p. 45)

DATE/TIME RECORDING

You can record videos together with the date and time.
Set this when you want to save the file with date and time display.
(The date and time cannot be deleted after recording.)
“Recording Videos with Date and Time” (☞ p. 62)

RECORD SETTING Menu (still image)



SCENE SELECT

Settings to suit the shooting condition can be selected.

“Shooting According to Scene (Subject)” (☞ p. 34)

*Displayed only in the manual recording mode.

FOCUS

Focus can be adjusted manually.

“Adjusting Focus Manually” (☞ p. 35)

*Displayed only in the manual recording mode.

BRIGHTNESS ADJUST

Adjusts the overall brightness of the screen.

“Adjusting Brightness” (☞ p. 36)

*Displayed only in the manual recording mode.

BACKLIGHT COMP.

Corrects the image when the subject appears dark due to backlight.

“Setting Backlight Compensation” (☞ p. 37)

*Displayed only in the manual recording mode.

WHITE BALANCE

Adjusts the color according to the light source.

“Setting White Balance” (☞ p. 38)

*Displayed only in the manual recording mode.

TELE MACRO

Enables close-up shots when using the telephoto (T) end of the zoom.

“Taking Close-up Shots” (☞ p. 39)

*Displayed only in the manual recording mode.

TOUCH PRIORITY AE/AF

Automatically adjusts focus and brightness based on the subjects' faces or selected area.

“Capturing Subjects Clearly (TOUCH PRIORITY AE/AF)” (☞ p. 46)

SELF-TIMER

Use this when taking a group photo.

“Taking Group Shots (Self-timer)” (☞ p. 60)

GAIN UP

Makes the subject appear bright automatically when recording in dark places.

Setting	Details
OFF	Deactivates the function.
ON	Electrically brightens the scene when it is dark.

Memo :

- Setting can be adjusted separately for videos.

“GAIN UP (Video)” (☞ p. 206)

SHUTTER MODE

Continuous shooting settings can be adjusted.

Setting	Details
RECORD ONE SHOT	Records one still image.
CONTINUOUS SHOOTING	Records still images continuously while the SNAPSHOT button is pressed.

Settings Menu

Memo :

- Some SD cards may not support continuous shooting.
 - The continuous shooting speed will drop if this function is used repeatedly.
-

SMILE SHOT

Automatically captures a still image upon detection of a smile.
“Capturing Smiles Automatically (SMILE SHOT)” (☞ p. 47)

SMILE%/NAME DISPLAY

Displays the names and smile levels (%) when faces are detected.
“Setting SMILE%/NAME DISPLAY” (☞ p. 52)

PET SHOT

Automatically captures a still image upon detection of the face of a pet, such as dogs or cats.
“Capturing Pets Automatically (PET SHOT)” (☞ p. 48)

IMAGE SIZE

Sets the image size (number of pixels) for still images.

Setting	Details
3840X2160(8M) 1920X1080(2M)	Takes still images with aspect ratio 16:9. <ul style="list-style-type: none">• The sides of still images recorded in 16:9 aspect ratio may be cut off when printed.
1440X1080(1.5M) 640X480(0.3M)	Takes still images with aspect ratio 4:3.

SPECIAL RECORDING Menu (still image)**AUTO REC**

Starts recording automatically by sensing the changes in subject's movement (changes in brightness) within the red frame displayed on the LCD monitor.
"Recording Automatically by Sensing Movements (AUTO REC)" (p. 59)

PLAYBACK SETTING Menu (video)



SEARCH DATE

Narrows down the video index screen according to recording dates.
“Searching for a Specific Video/Still Image by Date” (☞ p. 78)

DISPLAY DATE/TIME

Sets whether to display the recording date and time during video playback.

Setting	Details
OFF	Does not display the date and time during playback.
ON	Displays the date and time during playback.

DIGEST PLAYBACK

Plays back a digest of the recorded videos.
“DIGEST PLAYBACK” (☞ p. 73)

PLAYBACK PLAYLIST

Plays back the playlists that you have created.
“PLAYBACK PLAYLIST” (☞ p. 74)

PLAYBACK OTHER FILE

Plays videos with defective management information.
“PLAYBACK OTHER FILE” (☞ p. 75)

EDIT Menu (video)



PROTECT/CANCEL

Protects files from being deleted accidentally.

“Protecting/Releasing Protection of the Currently Displayed File” (☞ p. 83)

“Protecting/Releasing Protection of Selected Files” (☞ p. 84)

EDIT PLAYLIST

A list in which your favorite videos are arranged is called a playlist.

By creating a playlist, you can play back only your favorite videos in the order you like.

The original video file remains even when it is registered to a playlist.

“Creating Playlists with Selected Files” (☞ p. 86)

“Creating Playlists by Date” (☞ p. 88)

“Editing Playlists” (☞ p. 89)

TRIMMING

Select the required part of a video and save it as a new video file.

The original video remains in its existing location.

“Capturing a Required Part in the Video (TRIMMING)” (☞ p. 85)

PLAYBACK SETTING Menu (still image)



SEARCH DATE

Narrows down the still image index screen according to recording dates.
“Searching for a Specific Video/Still Image by Date” (☞ p. 78)

SLIDE SHOW EFFECTS

Sets the transition effects in slideshow playback.

Setting	Details
SLIDE	Switches the screen by sliding in from right to left.
BLINDS	Switches the screen by dividing into vertical strips.
CHECKERBOARD	Switches the screen by changing through a checkered pattern.
RANDOM	Switches the screen with a random effect from SLIDE, “BLINDS”, and “CHECKERBOARD”.

Memo :

- Slideshow effects are not available when playing back still images in external devices (such as USB external hard disk drives).
-

EDIT Menu (still image)



PROTECT/CANCEL

Protects files from being deleted accidentally.

“Protecting/Releasing Protection of the Currently Displayed File” (⌘ p. 83)

“Protecting/Releasing Protection of Selected Files” (⌘ p. 84)

SETUP (video/still image)



Mobile User Guide

Displays the QR code to access the Mobile User Guide.

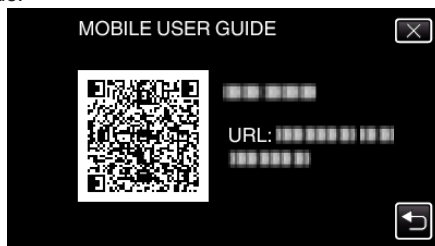

- The portal site appears when the QR code has been read correctly.
Select the model name of your camera to display its Mobile User Guide.

Memo :

- To read the QR code, a relevant application is required. Enter the URL in the internet browser manually if the QR code cannot be read.
- The Mobile User Guide is supported by Android devices and iPhone. You can view it on standard browsers such as Google Chrome (Android) and Mobile Safari (iPhone).
- QR Code is a registered trademark of Denso Wave Incorporated.

CLOCK ADJUST

Resets the current time or sets to the local time when using this unit overseas.

“Clock Setting” (☞ p. 20)

“Setting the Clock to Local Time when Traveling” (☞ p. 24)

“Setting Daylight Saving Time” (☞ p. 24)

DATE DISPLAY STYLE

Sets the order of year, month, day and the time display format (24H/12H).

Sorting Order	Time Display
month.day.year	12h
year.month.day	24h
day.month.year	-

LANGUAGE

The language on the display can be changed.

“Changing the Display Language” (☞ p. 22)

FACE REGISTRATION (recording only)

Registers the faces of people who are often shot with this unit.

“Registering Human Face Personal Authentication Information” (☞ p. 50)

MONITOR BRIGHTNESS

Sets the brightness of the LCD monitor.

Setting	Details
AUTO	Sets the brightness automatically to “4” when using outdoors and to “3” when using indoors.
4	Brightens the backlight of the monitor regardless of the surrounding conditions.
3	Sets to the standard brightness.
2	Darkens the backlight of the monitor regardless of the surrounding conditions.
1	Sets to dim brightness. Helps to save battery life when selected.

OPERATION SOUND

Turns on or off the operation sound.

Setting	Details
OFF	Turns off the operation sound.
ON	Turns on the operation sound.

AUTO POWER OFF

Prevents the situation of forgetting to turn off the power when this is set.

Setting	Details
OFF	Power is not turned off even if this unit is not operated for 5 minutes.
ON	Turns off the power automatically if this unit is not operated for 5 minutes.

Memo :

- When using battery, power is turned off automatically if this unit is not operated for 5 minutes.
- When using the AC adapter, this unit goes into standby mode.

QUICK RESTART

Enables the power to turn on quickly when the LCD monitor is opened again within 5 minutes.

Setting	Details
OFF	Deactivates the function.
ON	Enables the power to turn on quickly when the LCD monitor is opened again within 5 minutes.

Memo :

- The power consumption within 5 minutes after the LCD monitor is closed is reduced.

DEMO MODE

Plays a demonstration of the special features of this unit.

Setting	Details
OFF	Deactivates the function.
ON	Plays a demonstration of the special features of this unit.

Memo :

- This mode is not available in the playback mode.
- "SMILE%/NAME DISPLAY" is set to "ON" when the demo mode is activated.

"Setting SMILE%/NAME DISPLAY" (☞ p. 52)

TOUCH SCREEN ADJUST

Adjusts the response position of the buttons on the touch screen.

"Adjusting the Touch Panel" (☞ p. 17)

FACTORY PRESET

Returns all the settings to their default values.

FIRMWARE UPDATE

Updates the functions of this unit to the latest version.

For details, refer to the JVC homepage.

(When no program to update the software of this unit is available, nothing will be provided on the homepage.)

<http://www3.jvckenwood.com/english/support/index.html>

PC SOFTWARE UPDATE (GZ-E307/GZ-E305)

Updates the built-in PC software of this unit to the latest version.

For details, refer to the JVC homepage.

(When no program to update the computer software is available, nothing will be provided on the homepage.)

<http://www3.jvckenwood.com/english/support/index.html>

OPEN SOURCE LICENSES (recording only) (GZ-EX315)

Displays the open source software licenses that are used in this unit.

CONNECTION SETTINGS (video/still image)



DISPLAY ON TV

Displays icons and date/time on a TV screen.

Setting	Details
OFF	Does not display icons and date/time on TV.
ON	Displays icons and date/time on TV.

VIDEO OUTPUT

Sets the aspect ratio (16:9 or 4:3) according to the connecting TV.

Setting	Details
4:3	Select this when connecting to a conventional TV (4:3).
16:9	Select this when connecting to a widescreen TV (16:9).

HDMI OUTPUT

Sets the output from the HDMI connector of this unit when it is connected to a TV.

Setting	Details
AUTO	It is recommended to select "AUTO" usually.
576p	Select this when the video is not output in "AUTO" correctly.

HDMI CONTROL

Sets whether to link operations with an HDMI-CEC compliant TV.

Setting	Details
OFF	Turns off linked operations.
ON	Turns on linked operations.

AV TERMINAL (GZ-EX315)

Set the output connector of PAN CRADLE.

Setting	Details
AV	Set this when the output is made via the AV connector.
PAN CRADLE	Set this to use the Pan Cradle.

MEDIA SETTINGS (video/still image)



FORMAT SD CARD

Deletes all files on the SD card.

Setting	Details
FILE	Deletes all files on the SD card.
FILE + MANAGEMENT NO	Deletes all files on the SD card and resets the folder and file numbers to "1".

Caution :

- Not available for selection when no SD card is inserted.
 - All data on the SD card will be deleted when it is formatted.
Copy all files on the SD card to a computer before formatting.
 - Make sure that the battery pack is fully charged or connect the AC adapter as the formatting process may take some time.
-

USB CONNECTION MENU

Displayed when connecting the AC adapter after this unit is connected via USB.

■ GZ-EX315

PLAYBACK ON PC

- Displays videos recorded by this unit by using the LoLoFit for Everio.
“Installing the Provided Software” (☞ p. 95)
- Saves videos recorded by this unit on your computer without using the provided software.
“Backing Up Files Without Using Provided Software” (☞ p. 99)
“Copying to Mac Computer” (☞ p. 109)

CREATE DISC

Save videos recorded by this unit on a disc by using the BD/DVD drive on your computer and the LoLoFit for Everio.
To create a Blu-ray disc, purchase a paid version of LoLoFit for Everio.
<http://loilo.tv/us/product/33/page/27>

DIRECT DISC

Save videos recorded by this unit on a disc by using the BD/DVD drive on your computer.
To create a Blu-ray disc, purchase a paid version of LoLoFit for Everio.
<http://loilo.tv/us/product/33/page/27>

UPLOAD

Upload videos recorded by this unit to website for sharing files by using the LoLoFit for Everio.

BACK UP

Backup videos recorded by this unit to your computer by using the LoLoFit for Everio.
“Backing Up Files” (☞ p. 96)

Memo :

- Before making backup, load the SD card in which the videos are stored on this unit.
- After backing up your files using the provided software, they cannot be restored to this unit.
- Delete unwanted videos before making backup.
It takes time to back up many videos.
“Deleting Unwanted Files” (☞ p. 82)

■ GZ-E307/GZ-E305

PLAYBACK ON PC

- Displays videos recorded by this unit by using the Everio MediaBrowser 4.
“Installing the Provided Software (Built-in)” (☞ p. 102)
- Saves videos recorded by this unit on your computer without using the provided software.
“Backing Up Files Without Using Provided Software” (☞ p. 107)
“Copying to Mac Computer” (☞ p. 109)

CREATE DISC

Save videos recorded by this unit on a disc by using the BD/DVD drive on your computer and the Everio MediaBrowser 4.

DIRECT DISC

Save videos recorded by this unit on a disc by using the BD/DVD drive on your computer.

UPLOAD

Upload videos recorded by this unit to website for sharing files by using the Everio MediaBrowser 4.

BACK UP

Backup videos recorded by this unit to your computer using the Everio MediaBrowser 4.
“Backing Up All Files” (☞ p. 103)

Memo :

- Before making backup, load the SD card in which the videos are stored on this unit.
- After backing up your files using the provided software, they cannot be restored to this unit.
- Delete unwanted videos before making backup.
It takes time to back up many videos.
“Deleting Unwanted Files” (☞ p. 82)

Front

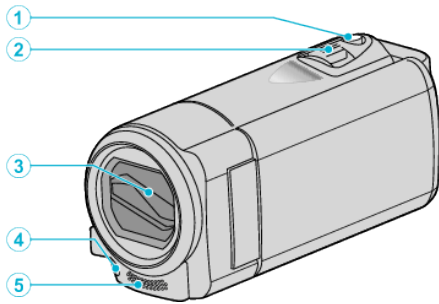

1 SNAPSHOT (Still Image Recording) Button

- Takes a still image.

2 Zoom/Volume Lever

- During shooting: Adjusts the shooting range.
- During playback (index screen): Moves to the next or previous page.
- During video playback: Adjusts the volume.

3 Lens Cover

- Do not touch the lens and lens cover.
- Do not cover the lens with your fingers during recording.

4 Light

- Turn on the light when shooting in dark places.

“LIGHT” (☞ p. 206)

5 Stereo Microphone

- Do not cover the microphone with your fingers during video recording.

Rear

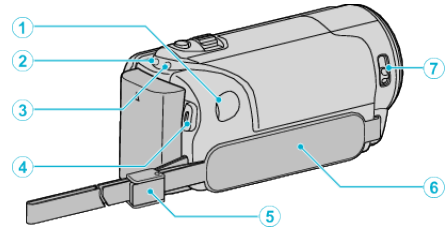

1 DC Connector

- Connects to an AC adapter to charge the battery.

2 ACCESS (Access) Lamp

- Lights up/blinks during recording or playback.
- Do not remove the battery pack, AC adapter, or SD card.

3 POWER/CHARGE (Power/Charge) Lamp

- Lights up: Power "ON"
- Blinks: Charging in progress
- Goes out: Charging finished

4 START/STOP (Video Recording) Button

- Starts/stops video recording.

5 Strap Lock

6 Grip Belt

- Pass your hand through the grip belt to hold this unit firmly.

“Grip Adjustment” (☞ p. 15)

7 Lens Cover Switch

- Opens and closes the lens cover.

Bottom

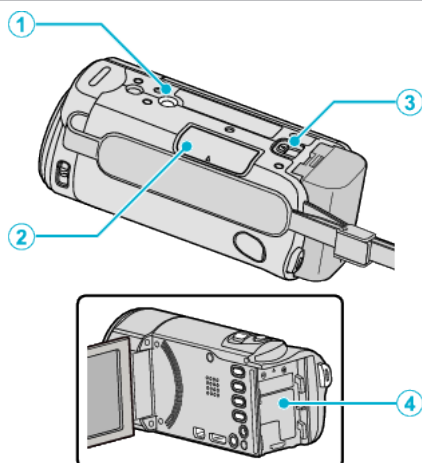
1 Tripod Mounting Hole

“Tripod Mounting” (☞ p. 23)

2 SD Card Slot

- Insert an optional SD card.

“Inserting an SD Card” (☞ p. 15)

3 Battery Release Lever

“Charging the Battery Pack” (☞ p. 14)

4 Battery Mount

Interior

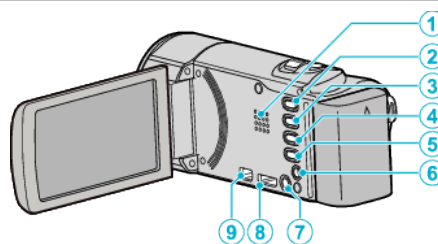
1 Speaker

- Outputs audio sound during video playback.

2  (Video/Still Image) Button

- Switches between video and still image modes.

3 SILENT Button

- Press and hold the SILENT button to turn on the Silent mode. The Silent mode can be cancelled by holding down the button again.

“Using the Silent Mode” (☞ p. 28)

4  (Image Stabilizer) Button

- The setting of image stabilizer changes with every press while video recording is stopped.

“Reducing Camera Shake” (☞ p. 54)

5 INFO (Information) Button

- Recording: Displays the remaining time (for video only) and battery power.
- Playback: Displays file information such as recording date.

6 AV Connector

- Connects to the AV connector of a TV, etc.

7  (Power) Button

- Press and hold to turn the power on/off while the LCD monitor is opened.

8 HDMI mini connector

- Connects to TV using an HDMI mini cable.

9 USB Connector

- Connects to computer using a USB cable.

LCD Monitor

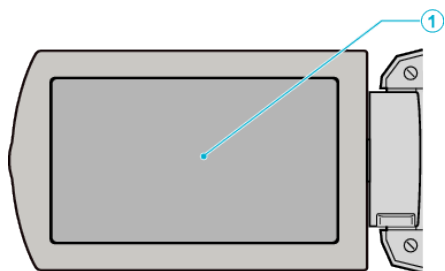

1 LCD Monitor

- Turns the power on/off by opening and closing.
- Enables self-portraits to be taken by rotating the monitor.

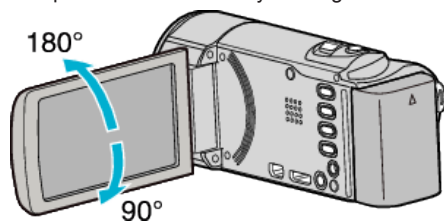

“Using the Touch Screen” (☞ p. 17)

“Names of Buttons and Functions on the LCD Monitor” (☞ p. 18)

Caution :

- Do not press against the surface with force or subject it to strong impact. Doing so may damage or break the screen.

Common Recording Indications

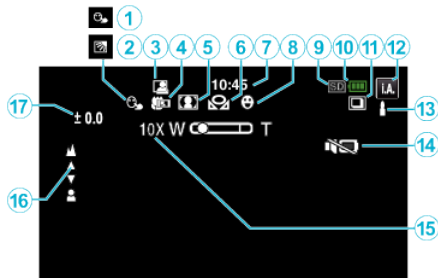

1 TOUCH PRIORITY AE/AF

“Capturing Subjects Clearly (TOUCH PRIORITY AE/AF)” (☞ p. 46)

2 Backlight Compensation

“Setting Backlight Compensation” (☞ p. 37)

3 Auto REC

“Recording Automatically by Sensing Movements (AUTO REC)” (☞ p. 59)

4 Tele Macro

“Taking Close-up Shots” (☞ p. 39)

5 Scene Select

“Shooting According to Scene (Subject)” (☞ p. 34)

6 WHITE BALANCE

“Setting White Balance” (☞ p. 38)

7 Time

“Clock Setting” (☞ p. 20)

8 SMILE SHOT

“Capturing Smiles Automatically (SMILE SHOT)” (☞ p. 47)

9 Media

10 Battery Indicator

“Checking the Remaining Recording Time” (☞ p. 63)

11 CONTINUOUS SHOOTING

“SHUTTER MODE (Video)” (☞ p. 207)

“SHUTTER MODE (Still Image)” (☞ p. 211)

12 Recording Mode

“Taking Videos in Auto Mode” (☞ p. 26)

“Manual Recording” (☞ p. 32)

13 Setting Scenes of Intelligent Auto

- Displays scenes detected automatically in the Intelligent Auto function. Multiple scenes may be detected.

“Scenes of Intelligent Auto” (☞ p. 27)

14 SILENT MODE

“Using the Silent Mode” (☞ p. 28)

15 Zoom

“ZOOM” (☞ p. 208)

16 Focus

“Adjusting Focus Manually” (☞ p. 35)

17 Brightness

“Adjusting Brightness” (☞ p. 36)

Video Recording

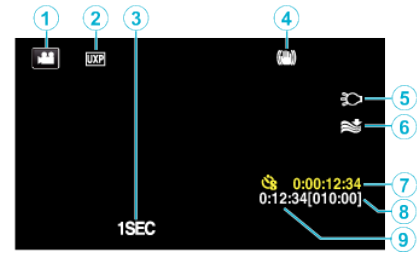

1 Video Mode

- Switches between video and still image modes.

2 Video Quality

“VIDEO QUALITY” (☞ p. 207)

3 TIME-LAPSE RECORDING(1SEC)

“Recording at Intervals (TIME-LAPSE RECORDING)” (☞ p. 56)

4 Image Stabilizer

“Reducing Camera Shake” (☞ p. 54)

5 Light

“LIGHT” (☞ p. 206)

6 Wind Cut

“WIND CUT” (☞ p. 207)

7 Time-Lapse Recording Counter

“Recording at Intervals (TIME-LAPSE RECORDING)” (☞ p. 56)

8 Remaining Recording Time

“Checking the Remaining Recording Time” (☞ p. 63)

9 Scene Counter

Still Image Recording

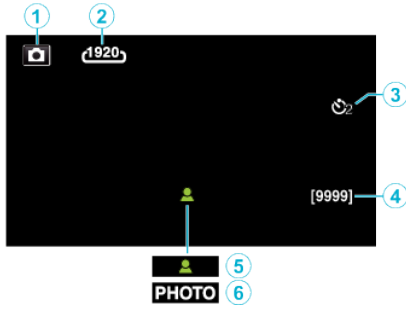

1 Still Image Mode

- Switches between video and still image modes.

2 Image Size

“IMAGE SIZE” (☞ p. 212)

3 Self-Timer

“Taking Group Shots (Self-timer)” (☞ p. 60)

4 Remaining Number of Shots

“Checking the Remaining Recording Time” (☞ p. 64)

5 Focus

6 Recording in Progress

Video Playback

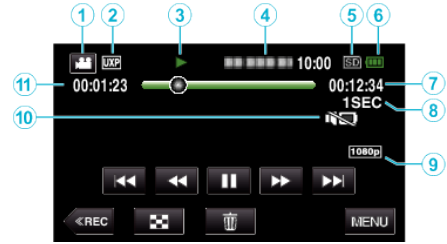

1 Video Mode

- Switches between video and still image modes.

2 Video Quality

“VIDEO QUALITY” (☞ p. 207)

3 Operation Indicator

“Operation Buttons for Video Playback” (☞ p. 67)

4 Date/Time

- Displays the recording date and time.

5 Media

6 Battery Indicator

“Checking the Remaining Recording Time” (☞ p. 63)

7 Playback Time

8 Time-Lapse Playback

“Time-Lapse Setting” (☞ p. 57)

9 1080p Output

“HDMI OUTPUT” (☞ p. 221)

10 SILENT MODE

“Using the Silent Mode” (☞ p. 28)

11 Scene Counter

Still Image Playback

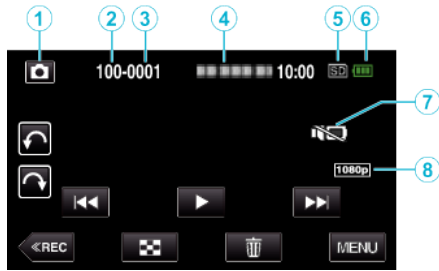

① Still Image Mode

- Switches between video and still image modes.

② Folder Number

③ File Number

④ Date/Time

- Displays the recording date and time.

⑤ Media

⑥ Battery Indicator

“Checking the Remaining Recording Time” (☞ p. 63)

⑦ SILENT MODE

“Using the Silent Mode” (☞ p. 28)

⑧ 1080p Output

“HDMI OUTPUT” (☞ p. 221)

When the unit is not working properly

Turning Off the Power

- 1 Close the LCD monitor.

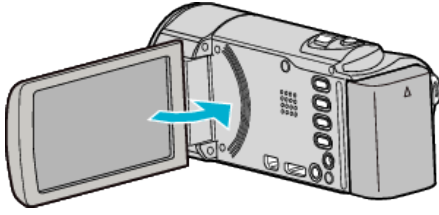

- 2 Remove the AC adapter and battery pack from this unit, reattach them, open the LCD monitor and this unit powers on automatically. (Reset complete)

Battery Pack

Unable to turn on the power when using the battery pack.

Recharge the battery pack.

“Charging the Battery Pack” (☞ p. 14)

Check whether the terminals are dirty.

If the terminal of this unit or the battery pack is dirty, wipe it with a cotton swab or something similar.

If you use any other battery packs besides JVC battery packs, safety and performance cannot be guaranteed. Be sure to use JVC battery packs.

Short usage time even after charging.

Battery deterioration occurs when a battery pack is charged repeatedly.

Replace the battery pack with a new one.

“Optional Accessories” (☞ p. 25)

Unable to charge the battery pack.

When the battery pack is fully charged, the lamp does not flash.

Check whether the terminals are dirty.

If the terminal of this unit or the battery pack is dirty, wipe it with a cotton swab or something similar.

Using a non-original AC adapter may result in damage to this unit. Be sure to use an original AC adapter.

The remaining battery display is not correct.

Remaining battery power is not displayed when the AC adapter is connected.

If this unit is used for long periods of time in high or low temperatures, or if the battery pack is repeatedly charged, the amount of remaining battery may not be displayed correctly.

Recording

Recording cannot be performed.

Check the  /  button.

“Interior” (☞ p. 225)

When there are multiple light sources and depending on the shooting conditions, exposure and focus may not be adjusted correctly in the Intelligent Auto mode. In this case, adjust the settings manually.

“Adjusting Focus Manually” (☞ p. 35)

Recording stops automatically.

Recording stops automatically as it cannot be performed for 12 or more consecutive hours according to specifications. (It may take some time to resume recording.)

Turn off this unit, wait for a while, and turn it on again. (This unit stops automatically to protect the circuit when the temperature rises.)

The continuous shooting speed of still images is slow.

The continuous shooting speed will drop if this function is used repeatedly. Continuous shooting speed may drop depending on the SD card or under certain recording conditions.

The focus is not adjusted automatically.

If you are recording in a dark place or a subject that has no contrast between dark and light, adjust the focus manually.

“Adjusting Focus Manually” (☞ p. 35)

Wipe the lens with a lens cleaning cloth.

Cancel manual focus on the manual recording menu.

“Adjusting Focus Manually” (☞ p. 35)

Zoom does not work.

Digital zoom is not available in the still image recording mode.

Zoom operation is not available in time-lapse recording. (Simultaneous still image recording and image stabilizer are also not available.)

To use digital zoom, set “ZOOM” in the menu accordingly.

“ZOOM” (☞ p. 208)

Mosaic-type noise occurs when recording scenes with fast movements or extreme changes in brightness.

Set the “VIDEO QUALITY” to “UXP” or “XP” for recording.

“VIDEO QUALITY” (☞ p. 207)

SD Card

Cannot insert the SD card.

Make sure not to insert the SD card in the wrong direction.
“Inserting an SD Card” (☞ p. 15)

Unable to copy to SD card.

To use SD cards that have been used on other devices, it is necessary to format (initialize) the SD card using “FORMAT SD CARD” from media settings.
“FORMAT SD CARD” (☞ p. 222)

Playback

Sound or video is interrupted.

Sometimes playback is interrupted at the connecting section between two scenes. This is not a malfunction.

There is no sound.

When the Silent mode is used, operation and playback sounds will not be output. Turn off the Silent mode.
“Using the Silent Mode” (☞ p. 28)
Set “OPERATION SOUND” in the common menu to “ON”.
“OPERATION SOUND” (☞ p. 219)
Audio sound is not recorded for videos taken in HIGH SPEED RECORDING/TIME-LAPSE RECORDING.
“Slow-motion (High-speed) Recording” (☞ p. 55)
“Recording at Intervals (TIME-LAPSE RECORDING)” (☞ p. 56)

The same image is displayed for a long time.

Use a high speed SD card (Class 4 or higher).
“Types of Usable SD Card” (☞ p. 16)
Clean the terminals of the SD card with a dry cotton swab or something similar.
Execute “FORMAT SD CARD” in the “MEDIA SETTINGS” menu. (All data will be deleted.)
“FORMAT SD CARD” (☞ p. 222)

The motion is choppy.

Use a high speed SD card (Class 4 or higher).
“Types of Usable SD Card” (☞ p. 16)
Clean the terminals of the SD card with a dry cotton swab or something similar.
Execute “FORMAT SD CARD” in the MEDIA SETTINGS menu. (All data will be deleted.)
“FORMAT SD CARD” (☞ p. 222)
Verify the system requirements of your computer when using LoiLoFit for Everio to play back. (GZ-EX315)
“Verifying System Requirements (Guideline)” (☞ p. 94)
Verify the system requirements of your computer when using Everio MediaBrowser 4 to play back. (GZ-E307/GZ-E305)
“Verifying System Requirements (Guideline)” (☞ p. 101)

Cannot find a recorded file.

Cancel the date search function.
“Searching for a Specific Video/Still Image by Date” (☞ p. 78)
Select “PLAYBACK OTHER FILE” in the menu. (Video files that have damaged management information can be played back.)
“PLAYBACK OTHER FILE” (☞ p. 75)

Images do not appear on the TV properly.

Disconnect the cable and connect again.
“Connecting via the HDMI Mini Connector” (☞ p. 80)
Turn off and on this unit again.

Images are projected vertically on the TV.

Set “VIDEO OUTPUT” in the “MEDIA SETTINGS” menu to “4:3”.
“VIDEO OUTPUT” (☞ p. 221)
Adjust the TV's screen accordingly.

The image displayed on TV is too small.

Set “VIDEO OUTPUT” in the “MEDIA SETTINGS” menu to “16:9”.
“VIDEO OUTPUT” (☞ p. 221)

When connected to the TV via the HDMI mini cable, proper images and sounds are not output.

Images and sounds may not be output properly depending on the TV connected. In such cases, perform the following operations.
① Disconnect the HDMI mini cable and connect it again.
② Turn off and on this unit again.

“Connecting via the HDMI Mini Connector” (☞ p. 80)

Editing/Copying

Unable to delete file.

Files (videos/still images) that are protected cannot be deleted. Release protection before deleting the file.
“Protecting Files” (☞ p. 83)

BACK-UP menu does not disappear.

While the USB cable is connected, the “BACK UP” menu is displayed.

Computer

Unable to copy files to the computer's HDD.

If the provided software LoiLoFit for Everio is not installed, some functions may not work properly.

"Installing the Provided Software" (☞ p. 95)

Before making backup, make sure that enough free space is left in the computer's hard disk (HDD).

Unable to copy files to DVD or Blu-ray disc with a PC.

To record to discs, a recordable DVD or Blu-ray drive is required for the computer in use.

Cannot upload the file to YouTube.

Check if you have created an account with YouTube. (You need a YouTube account to upload files to YouTube.)

Changing videos to the file format for uploading cannot be performed on this unit.

Refer to the help file of the provided software LoiLoFit for Everio (GZ-EX315)

Refer to the help file of the provided software Everio MediaBrowser 4 (GZ-E307/GZ-E305)

I am using a Mac computer.

Copy the files to a Mac computer using the following method.

"Copying to Mac Computer" (☞ p. 109)

The computer cannot recognize the SDXC card.

Confirm and update the OS of your computer.

"When your computer cannot recognize the SDXC card" (☞ p. 16)

Screen/Image

The LCD monitor is difficult to see.

The LCD monitor may be difficult to see if used in bright areas such as under direct sunlight.

A band or a ball of bright light appears on the LCD monitor.

Change the direction of this unit to prevent the light source from coming into view. (A band or a ball of bright light may appear when there is a bright light source near this unit, but this is not a malfunction.)

The recorded subject is too dark.

Use backlight compensation when the background is bright and the subject is dark.

"Setting Backlight Compensation" (☞ p. 37)

Use "NIGHTALIVE" in SCENE SELECT.

"Shooting According to Scene (Subject)" (☞ p. 34)

Use "GAIN UP" in the menu.

"GAIN UP" (☞ p. 206)

Set "BRIGHTNESS ADJUST" in the recording menu to the "+" side.

"Adjusting Brightness" (☞ p. 36)

The recorded subject is too bright.

Set the backlight compensation to "OFF" if it is being used.

"Setting Backlight Compensation" (☞ p. 37)

Set "BRIGHTNESS ADJUST" in the recording menu to the "-" side.

"Adjusting Brightness" (☞ p. 36)

The color looks strange. (Too bluish, too reddish, etc.)

Wait for a while until natural colors are achieved. (It may take some time for white balance to be adjusted.)

Set "WHITE BALANCE" in the recording menu to "MANUAL". Select from "FINE"/"CLOUD"/"HALOGEN"/"MARINE:BLUE"/"MARINE:GREEN"

according to the light source.

Select "MWB" and adjust accordingly.

Set "WHITE BALANCE" in the recording menu to "MANUAL". Select from "FINE"/"CLOUD"/"HALOGEN" according to the light source. Select "MWB"

and adjust accordingly.

"Setting White Balance" (☞ p. 38)

The color looks different.

Set "WHITE BALANCE" in the recording menu accordingly.

"Setting White Balance" (☞ p. 38)

There are bright or dark spots on the screen.

While the LCD monitor screen has more than 99.99% effective pixels, 0.01% of the pixels may be bright spots (red, blue, green) or dark spots. This is not a malfunction. The spots will not be recorded.

Other Problems

The buttons on the touch screen do not work.

Tap the buttons on the touch screen with your fingers or the stylus pen. The buttons may not respond if you touch them with your fingernails or with gloves on.

Save the recorded data before requesting service.

① Connect to computer using a USB cable.

The "SELECT DEVICE" menu appears.

② Press and hold the START/STOP button for more than 2 seconds.

The "PLAYBACK ON PC" appears.

Operations are to be performed on the computer after the screen switches.

The image is grainy.

When digital zoom is used, the image becomes grainy as it is digitally enlarged.

This unit heats up.

This is not a malfunction. (This unit may become warm when used for a long time.) Stop using the unit if it gets too warm.

The language on the display changed.

It may occur when you connect this unit to a TV with different language setting using an HDMI mini cable.

"Operating in Conjunction with TV via HDMI" (☞ p. 81)

When connected to the TV via the HDMI mini cable, proper images and sounds are not output.

Images and sounds may not be output properly depending on the TV connected. In such cases, perform the following operations.

① Disconnect the HDMI mini cable and connect it again.

② Turn off and on this unit again.

"Connecting via the HDMI Mini Connector" (☞ p. 80)

HDMI-CEC functions do not work properly, and the TV does not work in conjunction with this unit.

TVs may operate differently depending on the specifications, even if they are HDMI-CEC compliant. Therefore, the HDMI-CEC functions of this unit cannot be guaranteed to operate in combination with all the TVs. In such cases, set "HDMI CONTROL" to "OFF".

"HDMI CONTROL" (☞ p. 221)

The unit operates slowly when switching between video mode and still image mode, or when switching the power on or off.

It is recommended that you copy all videos and still images onto your computer, and erase the files from this unit. (If there are many recorded files on this unit, it takes time for the unit to respond.)

This unit does not function properly and error messages appear.

This unit is a microcomputer-controlled device. Electrostatic discharge, external noise and interference (from a TV, a radio, etc.) might prevent it from functioning properly. In such a case, turn off the power, then remove the AC adapter and battery pack. This unit will be reset.

Operation disabled since the POWER/CHARGE lamp and the ACCESS lamp are blinking

After closing the LCD monitor, remove power source (battery and AC adapter). Then, attach the battery and AC adapter again, and turn on the power by opening the LCD monitor. If these operations won't solve the problem, contact your JVC dealer or the JVC service center.

Disclaimer

- We shall not be held responsible for loss of recorded contents when recording videos/audio or playback cannot be operated due to malfunctions in this unit, provided parts, or SD card.

- Once deleted, recorded contents (data), including data loss due to malfunctions in this unit, cannot be restored. Please be forewarned.

- JVC will not be responsible for any lost data. Please be forewarned.
- In order for quality improvement, defective recording medium is subject to be analyzed. Therefore, it may not be returned.

Error Message?

CHECK LENS COVER

Open the lens cover.

SET DATE/TIME!

Connect the AC adapter, charge the battery for more than 24 hours and set the clock. (If the message still appears, the clock battery is exhausted.)

Consult your nearest JVC dealer.)

“Clock Setting” (☞ p. 20)

COMMUNICATION ERROR

Reconnect the USB cable.

Turn off this unit and the devices connected to it, and turn them on again.

Reattach the battery pack.

Turn off and on this unit again.

MEMORY CARD ERROR!

Check that the card is supported by this unit.

“Types of Usable SD Card” (☞ p. 16)

Turn off and on this unit again.

Remove the AC adapter and battery pack, then remove and re-insert the SD card.

Remove any dirt from the SD card terminals.

If the above does not solve the problem, back up your files and execute

“FORMAT SD CARD” in the “COMMON” menu. (All data will be deleted.)

“FORMAT SD CARD” (☞ p. 222)

NOT FORMATTED

Select “OK”, then select “YES” on the “DO YOU WANT TO FORMAT?” screen.

RECORDING FAILURE

Turn off and on this unit again.

CANNOT TAKE MORE STILL IMAGES AT THIS TIME

Stop video recording before taking still images. (If the SD card is removed and inserted during video recording, still images cannot be recorded.)

PLAYBACK FAILED

Remove and re-insert the SD card.

“Inserting an SD Card” (☞ p. 15)

Remove any dirt from the SD card terminals.

Insert the SD card before turning on the power.

Do not subject this unit to any strong impact or vibration.

VIDEO MANAGEMENT FILE IS DAMAGED, RECOVERY IS REQUIRED TO RECORD/PLAYBACK, RECOVER?

Select “OK” to restore. (Videos that cannot be restored will not be displayed on the index screen, but you may be able to play them back using

“PLAYBACK OTHER FILE” in the menu.)

“PLAYBACK OTHER FILE” (☞ p. 75)

UNSUPPORTED SCENE!

Use files recorded with this unit. (Files recorded with other devices may not be playable.)

UNSUPPORTED FILE!

Use files recorded with this unit. (Files recorded with other devices may not be playable.)

THIS FILE IS PROTECTED

Switch off the “PROTECT/CANCEL” function in the “EDIT” menu.

“Protecting Files” (☞ p. 83)

CHECK CARD'S WRITE PROTECTION SWITCH

Set the write protect switch of the SD card to off.

INSUFFICIENT AVAILABLE SPACE

Delete files, or move files to a computer or other devices.

Replace the SD card with a new one.

RECORDABLE MANAGEMENT CAPACITY LEVEL HAS BEEN REACHED

① Move the files or folders to a computer or other device. (Back up your files.)

② Select “FILE + MANAGEMENT NO” in “FORMAT SD CARD” of the media settings menu. (All data on the SD card will be deleted.)

“FORMAT SD CARD” (☞ p. 222)

SCENE QUANTITY EXCEEDED LIMIT

① Move the files or folders to a computer or other device. (Back up your files.)

② Select “FILE + MANAGEMENT NO” in “FORMAT SD CARD” of the media settings menu. (All data on the SD card will be deleted.)

“FORMAT SD CARD” (☞ p. 222)

NUMBER OF FOLDERS OVERFLOW

① Move the files or folders to a computer or other device. (Back up your files.)

② Select “FILE + MANAGEMENT NO” in “FORMAT SD CARD” of the media settings menu. (All data on the SD card will be deleted.)

“FORMAT SD CARD” (☞ p. 222)

FILE QUANTITY LIMIT EXCEEDED

① Move the files or folders to a computer or other device. (Back up your files.)

② Select “FILE + MANAGEMENT NO” in “FORMAT SD CARD” of the media settings menu. (All data on the SD card will be deleted.)

“FORMAT SD CARD” (☞ p. 222)

PLAYLIST QUANTITY EXCEEDS LIMIT

Reduce the number of the playlist to 99 files or less. (Up to 99 playlists can be created.)

CANCELLED BECAUSE PLAYLIST AMOUNT EXCEEDED MAXIMUM LIMIT

When creating a DVD, reduce the number of playlists to be saved.

Reduce the number of videos to add to the playlist to 999 files.

“Creating Playlists from the Recorded Videos” (☞ p. 86)

PROCESSING CANCELLED DUE TO LIMITED SPACE FOR OPERATION

Reduce the number of videos to add to the playlist to 999 files.

“Creating Playlists from the Recorded Videos” (☞ p. 86)

RECORDING CANCELLED

Turn off and on this unit again.

Protect the unit from vibration and shock.

CAMERA TEMPERATURE IS HIGH PLEASE TURN CAMERA OFF TO ALLOW IT TO COOL DOWN PLEASE WAIT

Turn off the power of this unit, let and it cool down before turning on the power again.

POWER IS OFF, OR USB DEVICE IS UNSUPPORTED

Turn on the power of the connected USB device.

Connect the AC adapter to the DVD writer or BD writer (external Blu-ray drive).

Perform regular maintenance of this unit to enable it to be used for a long time.

Caution :

- Be sure to detach the battery pack, AC adapter, and power plug before performing any maintenance.

Camcorder

- Wipe this unit with a dry, soft cloth to remove any dirt.
- When it is extremely dirty, soak the cloth in a solution of neutral detergent, wipe the body with it, and then use a clean cloth to remove the detergent.

Caution :

- Do not use solvents such as benzene, thinner, or alcohol. Doing so may cause damage to the unit.
- When using a chemical cloth or cleaner, be sure to observe the warning labels and instructions of the product.
- Do not leave the device in contact with rubber or plastic products for a long time.

Lens/LCD Monitor

- Use a lens blower (commercially available) to remove any dust, and a cleaning cloth (commercially available) to wipe off any dirt.
Mold may form if the lens is left dirty.
- You can use a commercially available anti-reflection or protective film on the screen.
However, depending on the thickness of the film, operations on the touch screen may not be performed smoothly or the screen may darken slightly.

Camera

Item	Details
Power supply	Using AC adapter: DC 5.2 V Using battery pack: DC 3.6 V (GZ-EX315) Using battery pack: DC 3.5 V - 3.6 V (GZ-E307/GZ-E305)
Power consumption	2.3 W(GZ-EX315) 2.2 W(GZ-E307/GZ-E305) (MONITOR BRIGHTNESS: 3 (standard)) Rated Current Consumption: 1A
Dimensions (mm)	50 x 57 x 116 (W x H x D: excluding grip belt)
Mass	(GZ-EX315) Approx. 200 g (camera only), Approx. 240 g (including supplied battery pack) (GZ-E307) Approx. 195 g (camera only), Approx. 235 g (including supplied battery pack) (GZ-E305) Approx. 195 g (camera only), Approx. 225 g (including supplied battery pack)
Operating environment	Allowable operating temperature: 0°C to 40°C Allowable storage temperature: -20°C to 50°C Allowable relative humidity: 35 % to 80 %
Image pickup device	1/5.8" 2,510,000 pixels (CMOS, back-illuminated) device
Recording area (Video)	AVCHD mode 1,010,000 to 2,290,000 pixels (image stabilizer: off, dynamic zoom: ON) iFrame (GZ-EX315) 920,000 to 1,770,000 pixels (dynamic zoom: ON)
Recording area (Still image)	1,710,000 pixels (4:3) 2,290,000 pixels (16:9)
Lens	F1.8 - 6.3, f= 2.9 mm to 116.0 mm Video AVCHD mode 35 mm conversion: 40.5 mm to 2,430 mm (dynamic zoom: ON) 35 mm conversion: 40.5 mm to 1,620 mm (dynamic zoom: OFF) iFrame mode 35 mm conversion: 46.0 mm to 2,530 mm (dynamic zoom: ON) 35 mm conversion: 46.0 mm to 1,840 mm (dynamic zoom: OFF) Still Image 35 mm conversion: 49.5 mm to 1,980 mm (4:3) 35 mm conversion: 40.5 mm to 1,620 mm (16:9)
Lowest illumination	3 lux 1 lux (SCENE SELECT: NIGHTALIVE)
Zoom (during video recording)	Optical zoom: Up to 40x Dynamic zoom: Up to 60x Digital zoom: Up to 200x
Zoom (during still image recording)	Optical zoom: Up to 40x
LCD monitor	3.0", 230,000 pixels, color LCD
Recording media	SD/SDHC/SDXC card (commercially available) "Types of Usable SD Card" (p. 16)
Clock battery	Rechargeable battery

Connectors

Item	Details
HDMI output connector	HDMI mini connector
AV output connector	Video output: 1.0 V (p-p), 75 Ω Audio output: 300 mV (rms), 1 KΩ
USB connector	Mini USB Type B, USB 2.0 compliant

Video (AVCHD)

Item	Details
Recording/ Playback format	AVCHD standard Video: MPEG-4 AVC/H.264 Audio: Dolby Digital 2ch
Extension	.MTS
Signal system	PAL standard
Image quality (Video)	UXP 1920 x 1080 pixels Average Approximate 24 Mbps XP 1920 x 1080 pixels Average Approximate 17 Mbps SP 1920 x 1080 pixels Average Approximate 12 Mbps EP 1920 x 1080 pixels Average Approximate 4.8 Mbps SSW (16:9) 720 x 576 pixels (Interlaced) Average Approximate 6.2 Mbps SEW (16:9) 720 x 576 pixels (Interlaced) Average Approximate 3 Mbps
Sound quality (Audio)	48 kHz, 256 kbps

Video(iFrame)(GZ-EX315)

Item	Details
Recording/ Playback format	MP4 standard Video: MPEG-4 AVC/H.264 Audio: AAC (2ch)
Extension	.MP4
Signal system	PAL standard
Image quality (Video)	1280x720 1280 x 720 pixels Max 36 Mbps, average approx. 34 Mbps 960x540 960 x 540 pixels Max 28 Mbps, average approx. 26 Mbps
Sound quality (Audio)	48 kHz, average 128 kbps

Still Image

Item	Details
Recording format	JPEG standard
Extension	.JPG
Image size	“Approximate Number of Still Images (Unit: Number of Shots)” (p. 64)

AC Adapter (AC-V10M)

Item	Details
Power supply	AC 110 V to 240 V, 50 Hz/60 Hz
Output	DC 5.2 V, 1 A
Allowable operating temperature	0°C to 40°C (10°C to 35°C during charging)
Dimensions (mm)	83 x 28 x 40 (W x H x D: excluding cord and AC plug)
Mass	Approx. 77 g

Battery Pack (BN-VG108E) (GZ-E305)

Item	Details
Power voltage	3.5 V - 3.6 V
Capacity	860 mAh
Dimensions (mm)	31 x 21.5 x 43 (W x H x D)
Mass	Approx. 30 g

Battery Pack (BN-VG114E) (GZ-EX315/GZ-E307)

Item	Details
Power voltage	3.6 V
Capacity	1400 mAh
Dimensions (mm)	31 x 21.5 x 43 (W x H x D)
Mass	Approx. 40 g

Memo :

- The specifications and appearance of this product are subject to changes for further improvement without prior notice.

JVC