

JVC

CAMCORDER

Detailed User Guide

GZ-MS150

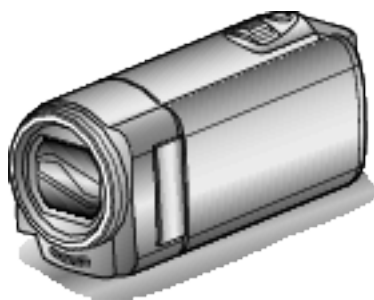

Everio

Table of Contents

Beginner's Guide	4
Charging	4
Recording	4
Playback	4
Shooting Tips	4
Holiday Season/Christmas	5
Wedding	6
Travel	7
Amusement Park	9

Getting Started

Key Features	10
Verifying the Accessories	11
Charging the Battery Pack	12
Charging with USB Cable	13
Grip Adjustment	14
Using as a Hand Strap	14
Inserting an SD Card	14
Types of Usable SD Card	15
Using an Eye-Fi Card	15
Turning On the Unit	16
Clock Setting	16
Resetting the Clock	17
Changing the Display Language	18
Holding this Unit	19
Tripod Mounting	19
Using this Unit Overseas	19
Charging the Battery Pack Overseas	19
Setting the Clock to Local Time when Traveling	20
Setting Daylight Saving Time	20
Optional Accessories	21

Recording

Taking Videos in Intelligent Auto Mode	22
Zooming	24
Manual Recording	24
Scene Selection	25
Adjusting Focus Manually	26
Adjusting Brightness	27
Setting White Balance	28
Setting Backlight Compensation	29
Taking Close-up Shots	30
Reducing Camera Shake	31
Capturing Human Subjects Clearly (Face Detection AE/AF)	31
Recording at Intervals (TIME-LAPSE RECORDING)	32
Recording Automatically by Sensing Movements (AUTO REC)	34
Remaining Recording Time/Battery Power	35

Playback

Playing Back Videos	37
Connecting to and Viewing on TV	39
Connecting via the AV Connector	39

Editing

Deleting Unwanted Files	40
Deleting the Currently Displayed File	40
Deleting Selected Files	41
Deleting All Files	42
Protecting Files	42
Protecting the Currently Displayed File	42
Protecting Selected Files	43
Protecting All Files	44
Releasing Protection of All Files	44

Copying

Dubbing Files by Connecting to a DVD Recorder or VCR	45
Creating a Disc Using a Connected Blu-ray Recorder	45
Copying to Windows PC	46
Verifying System Requirements (Guideline)	47
Installing the Provided Software	47
Backing Up All Files	48
Organizing Files	49
Backing Up Files Without Using Provided Software	50
List of Files and Folders	51
Copying to Mac Computer	51

Menu Settings

Operating the Menu	53
Recording Menu (Video)	54
FACE PRIORITY AE/AF	55
DIS	55
GAIN UP	56
WIND CUT	56
TIME-LAPSE RECORDING	56
AUTO REC	56
VIDEO QUALITY	57
ZOOM	57
CLOCK ADJUST	57
Manual Settings Menu	59
SCENE SELECT	59
FOCUS	59
BRIGHTNESS ADJUST	59
WHITE BALANCE	59
BACKLIGHT COMP.	59
TELE MACRO	59
Playback Menu (Video)	60
DELETE	61
PROTECT/CANCEL	61
CLOCK ADJUST	61
ON-SCREEN DISPLAY	61
Display Settings Menu	62
LANGUAGE	62
DATE DISPLAY STYLE	62
MONITOR BRIGHTNESS	63
Basic Settings Menu	64
DEMO MODE	64
OPERATION SOUND	65
AUTO POWER OFF	65
QUICK RESTART	66
UPDATE	66
FACTORY PRESET	66
Connection Settings Menu	67
DISPLAY ON TV	67
VIDEO OUTPUT	67
Media Settings Menu	68
FORMAT SD CARD	68

Names of Parts

Front	69
Rear	69
Bottom	70
Interior	70
LCD Monitor	71

Indications on the LCD monitor

Video Recording	71
Video Playback	72

Troubleshooting

Battery Pack	73
Recording	73
Card	74

Playback	74
Editing/Copying	75
Computer	75
Screen/Image	76
Other Problems	76
Error Message?	77

Maintenance 78

Specifications 79

Charging

- Refer to the operating instructions found in the animation on the Detailed User Guide.

Recording

- Refer to the operating instructions found in the animation on the Detailed User Guide.

Playback

- Refer to the operating instructions found in the animation on the Detailed User Guide.

Shooting Tips

Basic Way to Hold a Camcorder ~ Recording Stable Images ~



This is the standard way of shooting while standing up. Be sure to master this basic technique in order to achieve stable images.

■ [Getting Ready]

- 1 Open your feet to the width of your shoulders.
- 2 Keep the elbow of your right arm, which is holding the camcorder, close to your side.
- 3 Hold the LCD monitor with your left hand and adjust the angle accordingly.

Extending Your Hands to Shoot ~ High-Angle Shooting ~



Extend your hand when your subject is being hidden behind a crowd of people.

■ [Getting Ready]

- 1 Open your feet to the width of your shoulders.
- 2 Extend your right hand and hold the camcorder over your head.
- 3 Hold the LCD monitor with your left hand and adjust the angle accordingly.

Caution :

- Use this way of shooting only as a last resort as it is difficult to achieve stable images.
- Set to the wide angle as much as possible as the image will be prone to camera shake.
- Be considerate. Do not inconvenience the people around you.

Squatting and Shooting at Eye Level



Staying low is a common position to take when shooting small children. By recording from the eye level of the child, you can capture all his cute expressions clearly.

■ [Getting Ready]

- 1 Kneel down with your left knee while keeping your right foot on the ground.
- 2 Place the elbow of your right arm, which is holding the camcorder, on your right knee.
- 3 Hold the LCD monitor with your left hand and adjust the angle accordingly.

Panning

- Refer to the operating instructions found in the animation on the Detailed User Guide.

Use this method to shoot a wide angle of view.

■ [Getting Ready]

- 1 Shoot by rotating your body instead of moving your arms while keeping the basic way of holding a camcorder as stated above.
- 2 Stand facing the direction where the rotation will stop.
- 3 Twist your upper body to the direction where recording will start.
- 4 Press the start button and record for 2 seconds, then slowly twist back your body to face the front.
Record for another 2 seconds while facing the front, then press the stop button.
(The 90 degrees rotation should take about 5 seconds, giving the feeling of a slow motion.)

Holiday Season/Christmas

Record the happy Christmas celebration with your family!



Decorating the Tree and Preparing the Dinner

The decoration of tree and preparation of dinner are part of the joy of Christmas. Be sure to record these happy family times!

■ Decorating the tree



A tree is the most important thing to bring out the mood of Christmas. Simply the scene of all family members engaging in the decorating of a fir tree with various colorful ornaments is full of the feeling of happiness.

■ Preparing the Dinner



Record the scenes as everyone helps to prepare the feast of the night. You can film the mother who is cooking, the children who are helping, and of course, the process of making a cake!

Recording the Christmas Party



After all preparations, it is finally the Christmas party itself. Not only should you record the candle-blowing scene, but also the smiles of the family while being surrounded by good food, or even the father who is slightly drunk from champagne!

Finding the Presents



For children, the greatest joy of Christmas is receiving presents the next morning.

Their expression of delight when finding a present next to their pillow is a recording opportunity not to be missed. Get ready to shoot before the children wake up!

Wedding

Create an awesome wedding video for the bride and groom!



Discussing and Planning Before the Event

Before the day of the wedding reception, it is important to discuss with the bride and groom about various details such as the order of the ceremony and whether there are any entertainment programs or change of clothes. By understanding the preferences of the bride and groom, you will be able to shoot more appropriately.

■ Finding out the route of entrance



The highlight of a wedding reception is the entrance of the bride and groom. Find out which door they will enter from and the route they will take from the person-in-charge of the wedding hall in advance. Set up the tripod at a place where you can follow the couple using zoom without having to move around.

■ Number of times and timing of clothes-changing

Find out the timing of any changing of clothes so as to capture the scene well when the bride and groom enter again. You can also make use the time while the bride and groom are changing to record comments of well wishes from the guests.

Finding the Right Angle to Capture Both Bride and Groom

■ Composing the picture with the groom in front and the guests at the back



The main characters of a wedding are of course the bride and groom. Record their expressions clearly during the toast, speech, entertainment programs, and other scenes.

Another recommendation is to capture the face shots of the guests, then pan towards the groom. Picture composition containing the crowd of guests only lacks fun, so be sure to pay attention to the shooting angle and size.

Recording the Expressions and Comments of Guests

■ Setting the shot from eye level to chest level



You can record comments from the guest by going around asking, "Please say a few words for the bride and groom". This can be done at the guests' waiting room, when the bride and groom are changing, or during the entertainment programs.

Closing Up on the Bride's Face During the Thank You Speech

The climax of the event finally comes during the bride and groom's thank you speech and presentation of flowers. The touching words of appreciation from the bride and tears of joy from the parents are scenes that must not be missed.

Start by closing up on the bride's face using zoom. As the tears start to form in the bride's eyes, continue shooting for a little longer. Then, slowly zoom out to the wide angle to show the parents who are moved by the speech.

Advanced Operation with Two Camcorders

If video-editing is to be done, record using two camcorders so that a video with varying scenes can be created. You can try asking a close friend who has a camcorder at home.

Set the borrowed camcorder on a tripod to focus on taking close-up shots of the bride and groom. In this way, the other camcorder can be moved around to record other scenes, enabling an interesting video with changing scenes to be created through editing and compilation.

As most people own at least a digital camera nowadays, even if you are really unable to find an extra camcorder, inserting still pictures to the video at various points is also a good way to add variety. Do give it a try!

■ <Camcorder 1>

Closing up on the bride and groom all the time



■ <Camcorder 2>

Recording the congratulatory messages from friends at the same time



Travel

Capture all the good times of your domestic or overseas trips!



Bringing the Necessary Equipment

The necessary things to bring on a trip depends on your traveling purpose and the destination.

For overseas trips in particular, you have to think about what to bring in accordance to the local conditions.

Here are some suggestions for your consideration.

■ Camcorder

Think about how many hours of shooting you will usually perform in a day. Be sure to prepare enough recording medium especially for long overseas trips.

If you are recording in SD cards, get ready the sufficient number of cards, including some for backup.

■ Battery Pack

Prepare a battery pack that is ready for double the expected recording time in a day. For example, if you plan to record for 2 hours a day, prepare a battery pack that is ready for 4 hours (actual recording time).

For a day trip, you can prepare a battery with low capacity but for a long trip, do prepare a few batteries with high capacities.

■ AC Adapter

The JVC AC adapter supports voltages from 100 V to 240 V, and hence can be used anywhere in the world.

Bring along the adapter if you are traveling for a long time. Charge the battery pack while sleeping so that you can record with full battery power the next day.

■ Power Plug Adapter



The shape of the power plug varies according to countries. Be sure to check the shape of the power plug beforehand, and bring the appropriate power plug adapter.

“Charging the Battery Pack Overseas” (☞ p. 19)

■ Battery Charger



Recording cannot be performed when an AC adapter is connected to the camcorder for battery charging.

You can bring an additional battery charger to charge battery packs if you plan to use the camcorder for recording at night. You can also charge multiple battery packs by using both the battery charger and this camcorder at the same time.

■ Tripod



A tripod is an essential item to take stable images. Select an appropriate tripod in accordance to your purpose and style of traveling, such as a compact one to be used on a table or one that is at least 1 m tall.

Recording the Excitement Before Departure

It may be a little abrupt to start your travel video at the destination suddenly. Record also the preparations prior to departure if it is a family trip, or the time when everyone is gathered at the meeting place if you are traveling with your friends.

For overseas trips, taking a shot of the signs and displays at the airport of the flight you are taking may be useful for future reference.



Useful Shooting Techniques

Using Pan at the Places of Interest

Tourists spots with beautiful scenery or historical sites are places that you would certainly want to record.

To capture the magnificence of a scene which cannot be fitted into a single frame, try the panning technique.

Refer to the "Shooting Tips" found in this website on how to use panning effectively.

In addition, you may also like to take a shot of the signs or monuments that can often be found at the tourist spots.



Showing Everyone Having a Good Time

When taking a video, it is rather dull to shoot only the scenery or historical sites.

Talk about your feelings while recording the breath-taking scenery of an attraction so that it will be an interesting scene to view later.

Amusement Park

Take more shots of the smiling faces of everyone in the family!



■ <Without backlight compensation>



Taking Videos of Moving Subjects



■ <With backlight compensation>



Scenarios with changes in body movement are suitable for taking videos. This includes situations where there are rapid changes in facial expressions or voices of surprise and delight.

*Some amusement parks do not allow passengers to perform any recording. Be sure to check beforehand.

- [Examples] Merry-go-round, go kart, coffee cup, etc.

Inducing Responses by Calling Out



Videos with no waving of hands nor laughter are not only dull when you view them later, but also put the capability of the audio-recording function of the camcorder to a waste.

When recording, induce more reactions by enthusiastically waving your hands or shouting out "Is it fun?" and the like.

Advanced Operation with Backlight Compensation

It is useful to make use of backlight compensation when the subject's face is in backlight or when the expression cannot be seen clearly. Increase the brightness of the whole image by setting "BACKLIGHT COMP." if the faces appear too dark. Even the expressions of faces under shadows can be captured brightly and clearly.

"Setting Details" (☞ p. 29)





Key Features

Key features of your camcorder

- 1** i.AUTO (Intelligent Auto Recording): Detects 12 types of pre-set scenes
- 2** Digital Image Stabilizer
- 3** 40x Optical Zoom
- 4** Auto Recording: Automatically starts recording when subject enters the detecting area
- 5** Time-lapse Recording: Watch long hours of recording in a few seconds
- 6** Eye-Fi Card Ready: Upload Videos through your home Wi-Fi networks
- 7** USB and AV Out connectors

Verifying the Accessories

If any of the items are missing or defective, consult your JVC dealer or the nearest JVC service center.

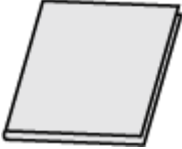
Illustration	Description
	<p>AC Adapter AC-V10M</p> <ul style="list-style-type: none"> Connects to this unit to charge the battery pack. It can also be used when recording or playing back videos indoors.
	<p>Battery Pack BN-VG107E</p> <ul style="list-style-type: none"> Attaches to this unit to supply power.
	<p>AV Cable</p> <ul style="list-style-type: none"> Connects this unit to a TV to play back recorded images on the TV.
	<p>USB Cable (Type A - Mini Type B)</p> <ul style="list-style-type: none"> Connects this unit to a computer.
	<p>CD-ROM</p> <ul style="list-style-type: none"> For installing the provided software LoiLoScope AX on a computer.
	<p>Basic User Guide</p> <ul style="list-style-type: none"> Read well and keep in a safe place where it can be accessed easily when necessary.

Memo :

- SD cards are sold separately.

“Types of Usable SD Card” (p. 15)

“Using an Eye-Fi Card” (p. 15)

- When using the AC adapter overseas, please prepare a commercially available converter plug for the country or region of visit.

“Charging the Battery Pack Overseas” (p. 19)

Charging the Battery Pack

Charge the battery pack immediately after purchase and when the remaining battery power is low.

The battery pack is not charged at the time of purchase.

1 Attach the battery pack.

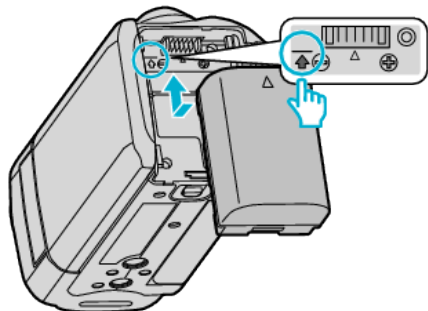

- Align the top of the battery with the mark on this unit, and slide in until the battery clicks into place.

2 Connect the AC adapter to the DC connector.

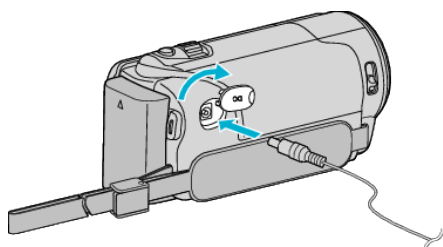

3 Plug in the power.

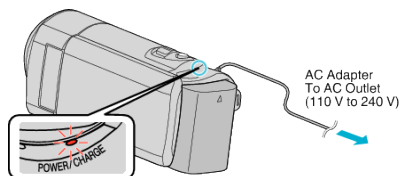

- The charging lamp blinks when charging is in progress. It goes out when charging is finished.

Caution :



Be sure to use JVC battery packs.

- If you use any other battery packs besides JVC battery packs, safety and performance cannot be guaranteed.
- Charging time: Approx. 1 h 50 m (using supplied battery pack)
The charging time is when the unit is used at 25°C. If the battery pack is charged outside the room temperature range of 10°C to 35°C, charging may take a longer time or it may not start.
The recordable and playable time may also be shortened under some usage conditions such as at low temperature.

Be sure to use the supplied JVC AC adapter.

- If you use any other AC adapters besides the supplied JVC AC adapter, malfunctions may occur.

Rechargeable Batteries :

- When using the battery in a low temperature environment (10°C or below), the operating time may be shortened, or it may not function properly. When using this unit outdoors in the winter weather, warm the battery, such as by placing it in the pocket, before attaching it. (Keep away from direct contact with a warm pack.)
- Do not expose the battery to excessive heat, such as direct sunlight or fire.
- After removing the battery, store it in a dry place between 15°C to 25°C.
- Keep a 30 % battery level () if the battery pack is not to be used for a long period of time. In addition, fully charge and then fully discharge the battery pack every 2 months, then continue to store it at a 30 % battery level ().

Memo :

- You can connect this unit to the AC adapter to record for long hours indoors.
(Battery charging begins when the LCD monitor is closed.)

- Charging is also possible with a USB cable.

“Charging with USB Cable” ( p. 13)

Detaching the Battery Pack

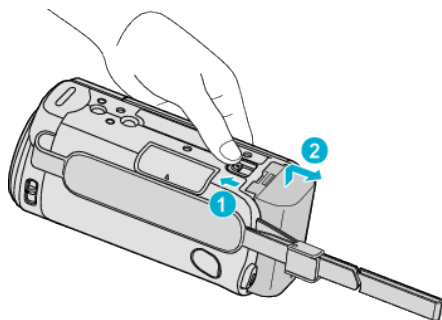

- Slide the battery release lever to detach the battery from this unit.

Approximate Battery Charging Time (Using AC Adapter)

Battery Pack	Charging Time
BN-VG107E (Supplied)	1 h 50 m
BN-VG114E	2 h 30 m
BN-VG121E	3 h 30 m
BN-VG138E	6 h 10 m

- When the battery life is reached, the recording time becomes shorter even if the battery pack is fully charged.
(Replace the battery pack with a new one.)

* The charging time is when the unit is used at 25°C. If the battery pack is charged outside the room temperature range of 10°C to 35°C, charging may take a longer time or it may not start. The recordable and playable time may also be shortened under some usage conditions such as at low temperature. "Approximate Recording Time (Using Battery)" (p. 36)

Charging with USB Cable

- 1 Close the LCD monitor to turn off the camcorder and disconnect the AC adapter as well as battery pack from the camcorder.
- 2 Turn on the computer and connect the USB cable to the camcorder.

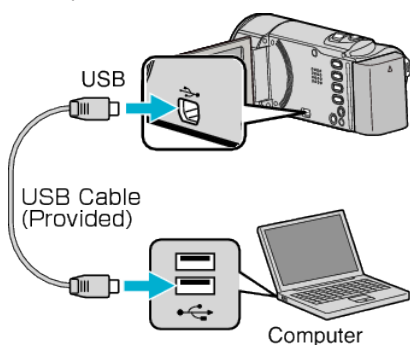

- Do not attach the battery pack before connecting the USB cable.
- 3 Attach the battery pack.
 - The charging lamp blinks when charging is in progress.
It goes out when charging is finished.

Memo :

- USB charging is not possible while the AC adapter is connected to the camcorder.
- Do not turn off or set the computer to sleep mode during charging (the charging will stop).
- With some types of computers, charging is possible even when the computer is turned off. Refer to the instruction manual of the computer or consult its manufacturer.
- Charging is also possible with an optional USB AC adapter (AC-V10L). If you use any other USB AC adapters besides JVC AC adapters, safety and performance cannot be guaranteed.
- If charging does not start, detach the battery pack and try again from step 1.

- You cannot record or play back videos while the camcorder is connected to a computer. Disconnect the USB cable after charging.

Approximate Battery Charging Time (Using USB Cable)

Battery Pack	Charging Time
BN-VG107E (Supplied)	9 h 30 m
BN-VG114E	18 h 30 m
BN-VG121E	25 h
BN-VG138E	45 h 30 m

Grip Adjustment

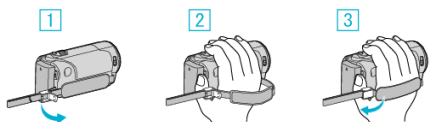

- 1 Open the lever on the strap lock
- 2 Adjust the length of the belt
- 3 Close the lever

Caution :

- Be sure to fasten the grip belt properly.
If the belt is loose, this unit may drop and result in injuries or damages.

Using as a Hand Strap

Adjust the length of the belt and loop it around your wrist.

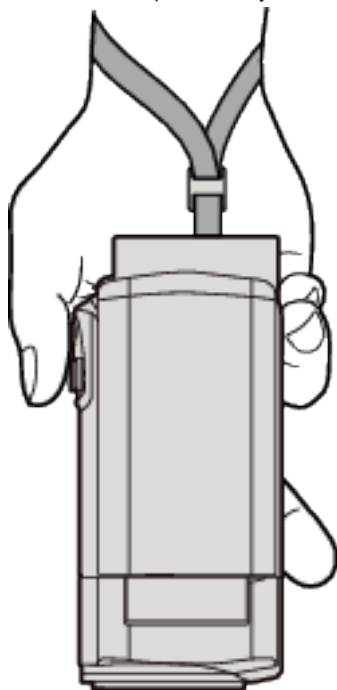

Inserting an SD Card

Insert a commercially available SD card before recording.
 “Types of Usable SD Card” (☞ p. 15)
 “Using an Eye-Fi Card” (☞ p. 15)
 “Approximate Video Recording Time” (☞ p. 36)

- 1 Close the LCD monitor.

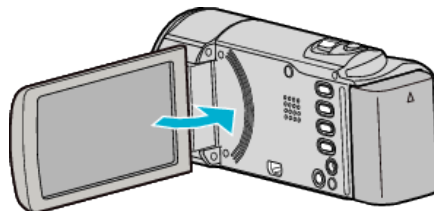

- 2 Open the cover.

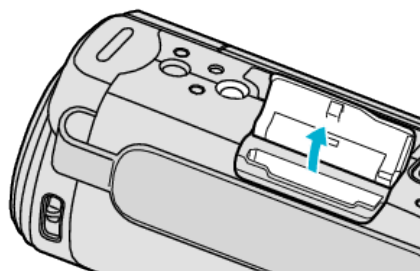

- 3 Insert an SD card.

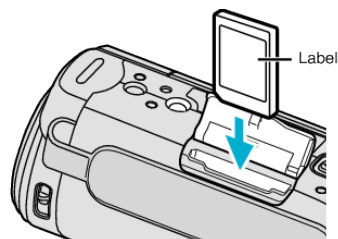

- Insert with the label facing outward.

Warning

- Make sure not to insert the card in the wrong direction. It may cause damage to the unit and card.
- Turn off the power of this unit before inserting or removing a card.
- Do not touch the metal contact area when inserting the card.

Memo :

- To use cards that have been used on other devices, it is necessary to format (initialize) the card using “FORMAT SD CARD” from media settings.

“FORMAT SD CARD” (☞ p. 68)

Removing the Card

Push the SD card inward once, then pull it out straight.

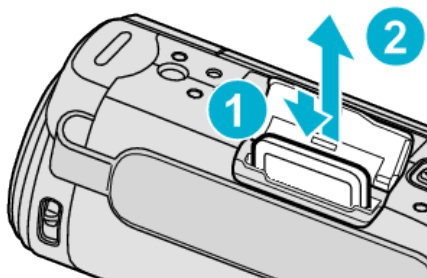

Types of Usable SD Card

The following SD cards can be used on this unit. Operations are confirmed on the SD cards from the following manufacturers.

- Panasonic
- TOSHIBA
- SanDisk

SDHC Card



- Use a Class 4 or higher compatible SDHC card (4 GB to 32 GB) for video recording.
- You can also use a Class 10 compliant SDHC/SDXC card.

SDXC Card



- Use a Class 4 or higher compatible SDXC card (Max. 64 GB).

Memo :

- Using SD cards (including SDHC/SDXC cards) other than those specified above may result in recording failure or data loss.
- Class 4 and Class 6 are guaranteed to have a minimum transfer rate of 4 MB/s and 6 MB/s respectively during reading or writing of data.
- To protect the data, do not touch the terminals of the SD card.

When your computer cannot recognize the SDXC card

Confirm and update the OS of your computer.

Windows XP / Windows XP SP1	Necessary to update to SP2 or higher.
Windows XP SP2 / Windows XP SP3	Necessary to download the update software. (KB955704) http://www.microsoft.com/downloads/details.aspx?FamilyID=1cbe3906-ddd1-4ca2-b727-c2dff5e30f61&displaylang=en
Windows Vista	Necessary to update to SP1 or higher.
Mac OS	Not compatible.

Using an Eye-Fi Card

Eye-Fi is an SD memory card with wireless LAN function. Using an Eye-Fi card, you can transfer videos to a computer or the web. (A broadband wireless LAN environment is required.) Use of Eye-Fi card may be illegal and prohibited in countries and regions where it has not been approved by competent authorities. Please contact Eye-Fi support for the details of approved countries and regions.

Types of Cards

The following Eye-Fi cards can be used on this unit.

- Eye-Fi X2 Series
- Eye-Fi Connect X2
- Eye-Fi Explore X2
- Eye-Fi Pro X2

Video files cannot be transferred without the Eye-Fi X2 series.

Using the Eye-Fi Card

Make settings on the Eye-Fi card with Eye-Fi Center. For how to install and operate the Eye-Fi Center, refer to its instruction manual.

- Recorded videos are automatically transferred. (The files already transferred earlier are not transferred again.)

Memo :

- You cannot transfer files during the recording mode, editing and formatting of the card.
- You cannot transfer video files larger than 2 GB. (as of December, 2010)
- Transfer may take long or be interrupted depending on the connection conditions.

Icon	Description
	Eye-Fi setting OFF (depends on Eye-Fi Center setting)
	Identifying the Eye-Fi card
	Ready for transfer from the Eye-Fi card
	Transferring from the Eye-Fi card (animated)

- We recommend using the AC adapter when transferring files of large size.
- If it doesn't operate properly, first make use of Eye-Fi Helper to confirm that the settings of the Eye-Fi card are correct. In addition, try the data transfer by inserting the Eye-Fi card into other equipment such as a computer.
- Do not use the camcorder in places where wireless use is prohibited such as on a plane.
- Before deleting a file, check that you have transferred it to a computer or uploaded it to a video sharing website.
- For the latest information on the Eye-Fi card, refer to the website of Eye-Fi, Inc.

<http://www.eye.fi/>

Turning On the Unit

You can turn the power of this unit on/off by opening or closing the LCD monitor.

- 1 Open the LCD monitor.

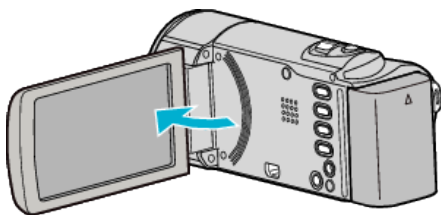

- The unit turns on.
- When the LCD monitor is closed, the unit turns off.

Clock Setting

The "SET DATE/TIME!" screen appears when you turn on this unit for the first time after purchase, when it has not been used for a long time, or when the clock is not set yet.

Set the clock before recording.

Memo : _____

To select/move cursor towards up/left or down/right, press the button UP/< or DOWN/>.

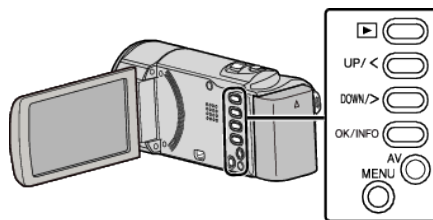

- 1 Open the LCD monitor.

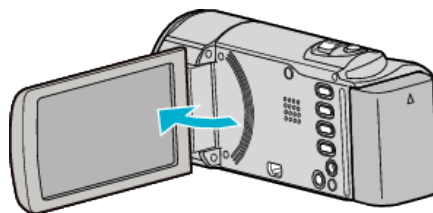

- The unit turns on.
- When the LCD monitor is closed, the unit turns off.

- 2 Select "YES" and press OK when "SET DATE/TIME!" is displayed.



- Press UP/< or DOWN/> to move the cursor.

- 3 Set the date and time.

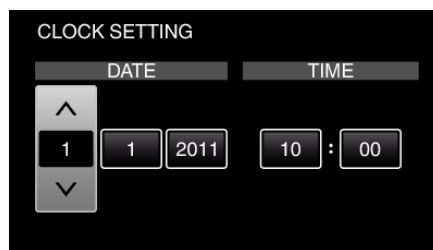

- Press UP/< or DOWN/> to adjust the setting value and press OK to confirm it. The cursor moves to the next item.
- Repeat this step to input the year, month, day, hour, and minute.
- To cancel and return to the previous screen, press MENU.

- 4 Press UP/< or DOWN/> to select the region where you live and press OK.

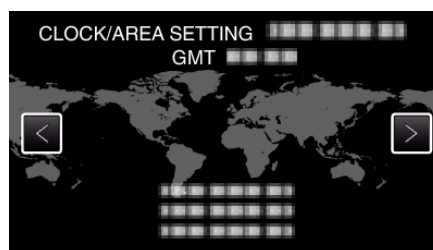

- The city name and time difference are displayed.
- To cancel and return to the previous screen, press MENU.

Memo : _____

- The clock can be reset again later.

“Resetting the Clock” (☞ p. 17)

- When using this unit overseas, you can set it to the local time for recording.
- “Setting the Clock to Local Time when Traveling” (☞ p. 20)
- “SET DATE/TIME!” is displayed when you turn on this unit after it has not been used for a prolonged period.
Connect the AC adapter for more than 24 hours to charge the internal clock battery of this unit before setting the clock.

“Charging the Battery Pack” (☞ p. 12)

- You can turn on or off the clock display during playback mode.

“ON-SCREEN DISPLAY” (☞ p. 61)

Resetting the Clock

Set the clock with “CLOCK ADJUST” from the menu.

Memo :

To select/move cursor towards up/left or down/right, press the button UP/< or DOWN/>.

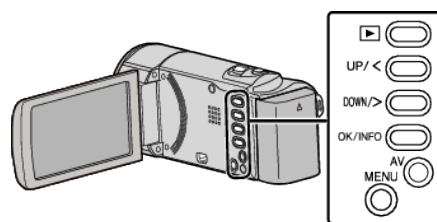

- 1 Press MENU.

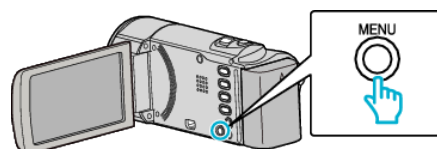

- 2 Select “CLOCK ADJUST” and press OK.

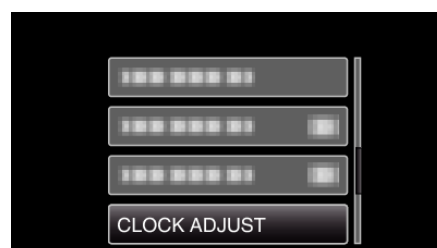

- Press UP/< or DOWN/> to move the cursor.
- To cancel and return to the previous screen, press MENU.

- 3 Select “CLOCK SETTING” and press OK.

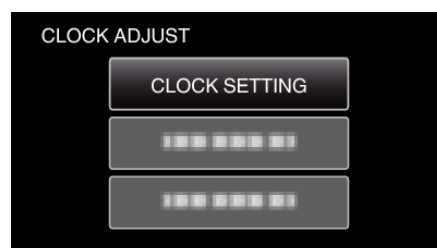

- Press UP/< or DOWN/> to move the cursor.
- To cancel and return to the previous screen, press MENU.

- 4 Set the date and time.

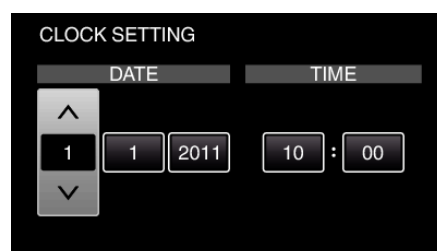

- Press UP/< or DOWN/> to adjust the setting value and press OK to confirm it. The cursor moves to the next item.
- Repeat this step to input the year, month, day, hour, and minute.
- To cancel and return to the previous screen, press MENU.

- 5 Press UP/< or DOWN/> to select the region where you live and press OK.

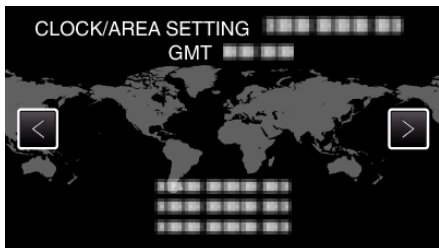

- The city name and time difference are displayed.
- To cancel and return to the previous screen, press MENU.

Changing the Display Language

The language on the display can be changed.

Memo :

To select/move cursor towards up/left or down/right, press the button UP/< or DOWN/>.

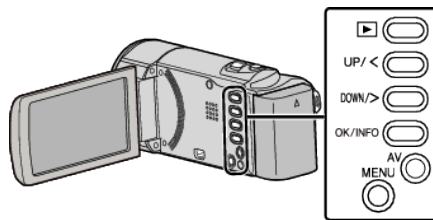

1 Press MENU.

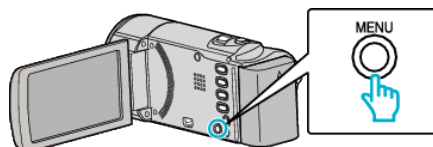

2 Select "DISPLAY SETTINGS" and press OK.

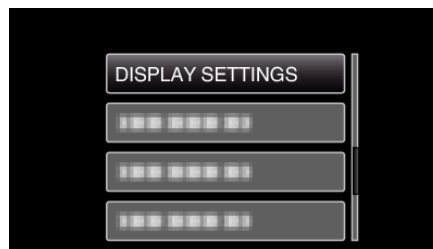

- Press UP/< or DOWN/> to move the cursor.
- To cancel and return to the previous screen, press MENU.

3 Select "LANGUAGE" and press OK.

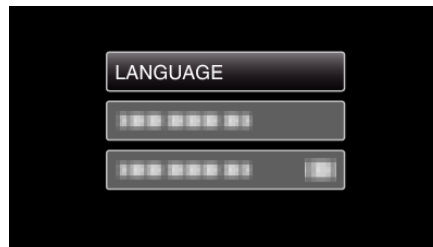

- Press UP/< or DOWN/> to move the cursor.
- To cancel and return to the previous screen, press MENU.

4 Select the desired language and press OK.



- Press UP/< or DOWN/> to move the cursor.
- To cancel and return to the previous screen, press MENU.

Holding this Unit

When holding this unit, keep your elbows close to your sides to prevent camera shake.



Caution : _____

- Be careful not to drop this unit during transportation.
- Guardians should pay close attention when this unit is being used by children.

Memo : _____

- If camera shake is excessive, use the digital image stabilizer.

“Reducing Camera Shake” (p. 31)

Tripod Mounting

This unit can be mounted on a tripod (or monopod). This is useful for preventing camera shake and recording from the same position.

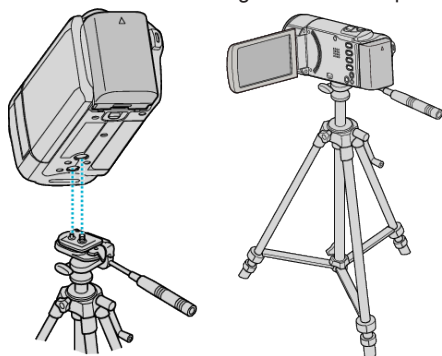

- To prevent this unit from falling off, check the tripod mounting screw holes and positioning holes on the unit carefully before mounting, and turn the screws until they are fastened firmly.

Caution : _____

- To prevent injuries or damages which may result if this unit falls off, read the instruction manual of the tripod (or monopod) to be used and make sure that it is securely attached.

Memo : _____

- It is recommended to use a tripod or monopod when recording in conditions prone to camera shake (such as in dark places or when zoomed to the telephoto end).
- Set the digital image stabilizer to (OFF) when using a tripod for recording.

“Reducing Camera Shake” (p. 31)

Using this Unit Overseas

The shape of the power outlet varies according to countries and regions. To charge the battery pack, you need a converter plug that matches the shape of the outlet.

“Charging the Battery Pack Overseas” (p. 19)

Change the date and time display to the local time by selecting your travel destination in “AREA SETTING” of “CLOCK ADJUST”.

“Setting the Clock to Local Time when Traveling” (p. 20)

When “ON” is selected in “DST SETTING” of “CLOCK ADJUST”, the time is set 1 hour ahead.

“Setting Daylight Saving Time” (p. 20)

Charging the Battery Pack Overseas

The shape of the power outlet varies according to countries and regions. To charge the battery pack, you need a converter plug that matches the shape of the outlet.

A	B	BF	C	O

North America	Europe	Oceania	Middle East
United States A	Iceland C	Australia O	Israel C
Canada A	Ireland C	Guam A	Iran C
Mexico A	United Kingdom B, BF	Tahiti C	Kuwait B, C
	Italy C	Tonga O	Jordan B, BF
Asia	Austria C	New Zealand O	
India B, C, BF	Netherlands C	Fiji O	Africa
Indonesia C	Canary Islands C		Algeria A, B, BF, C
Singapore B, BF	Greece C	Latin	Egypt B, BF, C
Sri Lanka B, C, BF	Switzerland C	Argentina O	Guinea C
Thailand A, BF, C	Sweden C	Colombia A	Kenya B, C
South Korea A, C	Spain A, C	Jamaica A	Zambia B, BF
China A, B, BF, C, O	Denmark C	Chile B, C	Tanzania B, BF
Japan A	Germany C	Haiti A	Republic of South Africa B, C, BF
Nepal C	Norway C	Panama A	Mozambique C
Pakistan B, C	Hungary C	Bahamas A	Morocco C
Bangladesh C	Finland C	Puerto Rico A	
Philippines A, BF, O	France C	Brazil A, C	
Vietnam A, C	Belgium C	Venezuela A	
Hong Kong Special Administrative Region B, BF	Poland B, C	Peru A, C	
Macau Special Administrative Region B, C	Portugal B, C		
Malaysia B, BF, C	Romania C		

Setting the Clock to Local Time when Traveling

Change the date and time display to the local time by selecting your travel destination in "AREA SETTING" of "CLOCK ADJUST". Restore the region settings after you returned from the trip.

Memo :
To select/move cursor towards up/left or down/right, press the button UP/< or DOWN/>.

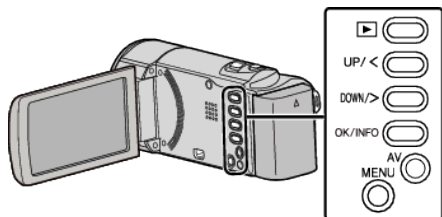

1 Press MENU.

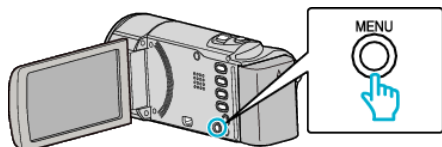

2 Select "CLOCK ADJUST" and press OK.



- Press UP/< or DOWN/> to move the cursor.
- To cancel and return to the previous screen, press MENU.

3 Select "AREA SETTING" and press OK.



- Press UP/< or DOWN/> to move the cursor.
- To cancel and return to the previous screen, press MENU.

4 Press UP/< or DOWN/> to select the area you are traveling to and press OK.

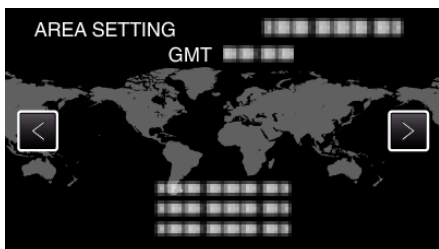

- The city name and time difference are displayed.
- To cancel and return to the previous screen, press MENU.

Memo :
• Setting "AREA SETTING" changes the clock time such that time difference is accounted for.
After returning to your country, re-select the region that was set initially to restore the original clock settings.

Setting Daylight Saving Time

When "ON" is selected in "DST SETTING" of "CLOCK ADJUST", the time is set 1 hour ahead.

Memo :
To select/move cursor towards up/left or down/right, press the button UP/< or DOWN/>.

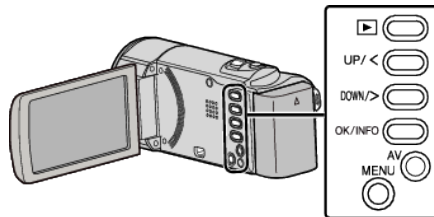

1 Press MENU.

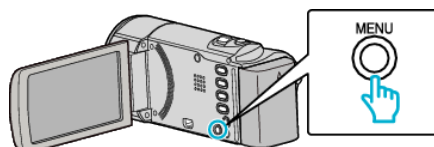

2 Select "CLOCK ADJUST" and press OK.

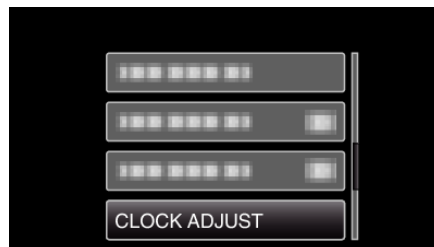

- Press UP/< or DOWN/> to move the cursor.
- To cancel and return to the previous screen, press MENU.

3 Select "DST SETTING" and press OK.

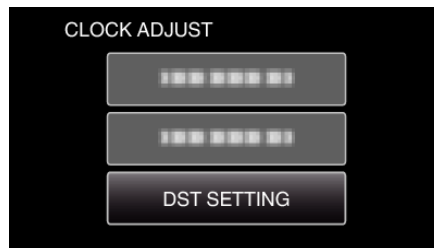

- Press UP/< or DOWN/> to move the cursor.
- To cancel and return to the previous screen, press MENU.

4 Press UP/< or DOWN/> to set daylight saving time and press OK.

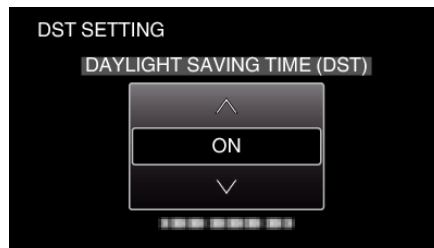

- To cancel and return to the previous screen, press MENU.

Memo :
• What is daylight saving time?
Daylight saving time is the system of setting the clock 1 hour ahead for a fixed period in summer. It is used mainly in the Western countries.
• Restore the daylight saving time settings after you returned from the trip.

Optional Accessories

You can record for a longer time by using the optional battery pack.

Product Name	Description
Battery Pack <ul style="list-style-type: none"> ● BN-VG114E ● BN-VG121E ● BN-VG138E 	<ul style="list-style-type: none"> ● Provides a longer recording time than the battery pack that comes with this unit. It can also be used as a spare battery pack.
Battery Charger <ul style="list-style-type: none"> ● AA-VG1 	<ul style="list-style-type: none"> ● Enables the battery pack to be charged without using this unit.

Memo : _____

- For more information, refer to the catalog.
- BN-VG107E is the same battery pack that comes with this unit.
- File copying by connecting this unit to a DVD writer is not supported.

Approximate Recording Time (Using Battery)

Battery Pack	Actual Recording Time	Continuous Recording Time
BN-VG107E (Supplied)	40 m (35 m)	1 h 5 m (1 h)
BN-VG114E	1 h 15 m (1 h 5 m)	2 h 10 m (1 h 55 m)
BN-VG121E	1 h 55 m (1 h 40 m)	3 h 15 m (2 h 55 m)
BN-VG138E	3 h 20 m (3 h)	5 h 45 m (5 h 20 m)

- The above are values when "MONITOR BRIGHTNESS" is set to "3" (standard).
(): Values when "MONITOR BRIGHTNESS" is set to "4" (brighter)
- The actual recording time may be shorter if zooming is used or if recording is stopped repeatedly.
(It is recommended to prepare battery packs ready for three times the expected recording time.)
- When the battery life is reached, the recording time becomes shorter even if the battery pack is fully charged.
(Replace the battery pack with a new one.)

Taking Videos in Intelligent Auto Mode

You can record without worrying about the setting details by using the Intelligent Auto mode. Settings such as exposure and focus will be adjusted automatically to suit the shooting conditions.

- In case of specific shooting scenes such as backlight (☀️), night view (🌙), person (👤) etc., its icon is displayed on the screen.
- Before recording an important scene, it is recommended to conduct a trial recording.

Memo :

To select/move cursor towards up/left or down/right, press the button UP/< or DOWN/>.

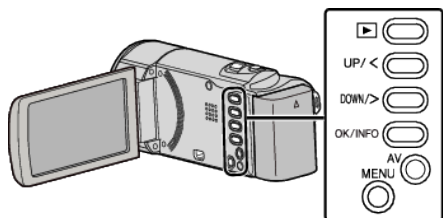

1 Open the lens cover.

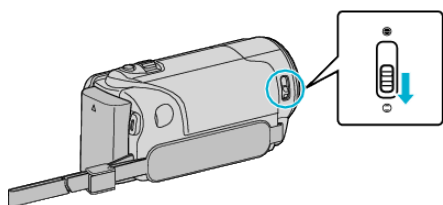

2 Open the LCD monitor.

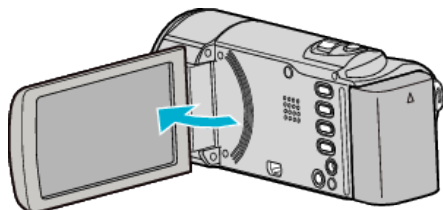

- The unit turns on and the video mode icon appears.
- When the LCD monitor is closed, the unit turns off.

3 Check if the recording mode is Intelligent Auto.

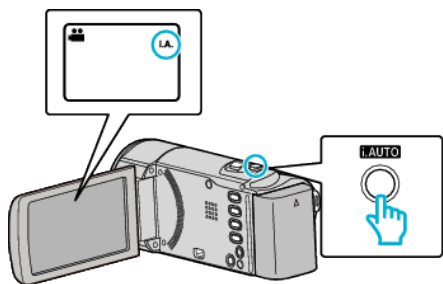

- If the mode is **M** Manual, press the i.AUTO button to switch. The mode changes between Intelligent Auto and Manual with every press.

4 Start recording.

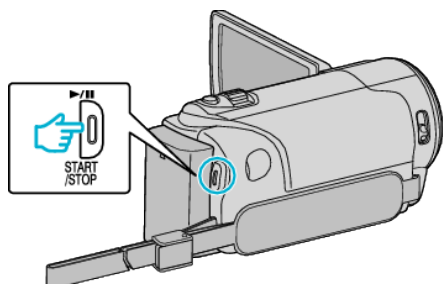





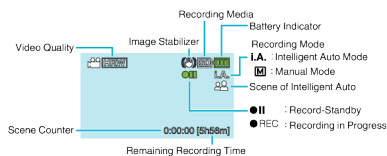







- Press again to stop.

Indications During Video Recording



Display Icon	Description
Recording Mode	Press the i.AUTO button to switch the recording mode between i.A. (Intelligent Auto) and M (Manual).
Video Quality	Displays the icon of the “VIDEO QUALITY” setting selected in the recording menu. “VIDEO QUALITY” (☞ p. 57)
Remaining Recording Time	Displays the remaining time for video recording.
● REC Recording in Progress	Appears when video recording is in progress.
● Record-Standby	Appears when video recording is paused.
Scene Counter (Recorded Time)	Displays the elapsed time of the video that is currently being recorded.
Recording Media	Displays the icon of the recording media.
Battery Indicator	Displays the approximate remaining battery power. Details of the battery power can be displayed by pressing the OK/INFO button. “Remaining Recording Time/Battery Power” (☞ p. 35)
Image Stabilizer	Sets whether to reduce camera shake. “Reducing Camera Shake” (☞ p. 31)

■ Scenes of Intelligent Auto

Display Icon	Description
	Closes up on the subject while the background is blurred.
	Focuses on both person and background when the zoom lever is adjusted to the wide angle (W) end.
	Focuses at a far distance and captures a sharp image.
	Captures the subject without raising sensitivity nor using flash when the surrounding is dark.
	Reproduces the night scene at a shutter speed that is lower than usual.
	Reproduces the blue color of sky and sea vividly without darkening the subject due to strong sunlight from the background.
	Focuses on a near object and reproduces its colors vividly.
	Reproduces the green color of trees vividly.
	Reproduces the glowing colors of sunset.
	Adjusts settings so that the subject does not appear too dark due to backlight.
	Uses flash so that a person appears clearly and reproduces the colors of the background vividly.
	Focuses on a near object and reproduces its colors vividly while using flash.

Memo :

- Scenes can be detected according to the shooting conditions and automatically adjusted in Intelligent Auto mode.
- Some functions may not work properly depending on the shooting conditions.

Useful Settings for Recording

- The aspect ratio for recording can be switched between 16:9 and 4:3.
“VIDEO QUALITY” (☞ p. 57)
- When “QUICK RESTART” is set to “ON”, this unit turns on immediately if you open the LCD monitor within 5 minutes after the power is turned off by closing the monitor.
“QUICK RESTART” (☞ p. 66)
- When “AUTO POWER OFF” is set to “ON”, this unit turns itself off automatically to conserve power when it is not operated for 5 minutes. (only when using the battery pack)
“AUTO POWER OFF” (☞ p. 65)
- When “FACE PRIORITY AE/AF” is set to “ON” (default setting), this unit detects faces and automatically adjusts its brightness and focus to record the faces more clearly.
“Capturing Human Subjects Clearly (Face Detection AE/AF)” (☞ p. 31)

Caution :

- Do not expose the lens to direct sunlight.
- Do not use this unit in the rain, snow, or places with high humidity like the bathroom.
- Do not use this unit in places subject to excessive humidity or dust, as well as places exposed to steam or smoke directly.
- Do not remove the battery pack, AC adapter, or SD card when the access lamp is lighted. The recorded data may become unreadable.
- Make a backup of important recorded data.
It is recommended to copy your important recorded data to a DVD or other recording media for storage.
JVC will not be responsible for any lost data.

Memo :

- Check the remaining recording time in the media before you start shooting. If there is not enough space, move (copy) the data to a computer or disc.
- Do not forget to make copies after recording!
- Recording stops automatically as it cannot be performed for 12 or more consecutive hours according to specifications. (It may take some time to resume recording.)
- For long recordings, the file is split into two or more files if the size exceeds 4 GB.
- You can connect this unit to the AC adapter to record for long hours indoors.

Zooming

The angle of view can be adjusted using zoom.

- Use the W end (wide angle end) to shoot a wider field of view.
- Use the T end (telephoto end) to magnify the subject for shooting.

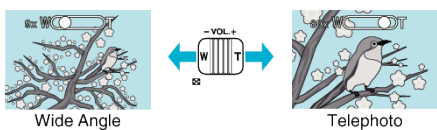

Memo :

- You can expand the zoom area without degrading the image quality by using dynamic zoom.
- When digital zoom is used, the image becomes grainy as it is digitally enlarged.
- The zoom ratio range can be changed.

“ZOOM” (p. 57)

Manual Recording

You can adjust settings, such as brightness, by using the manual mode.

Memo :

To select/move cursor towards up/left or down/right, press the button UP/< or DOWN/>.

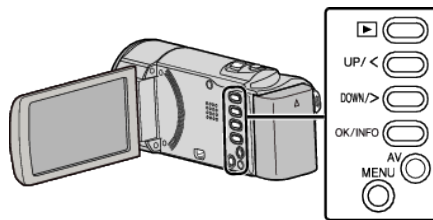

- 1 Open the lens cover.

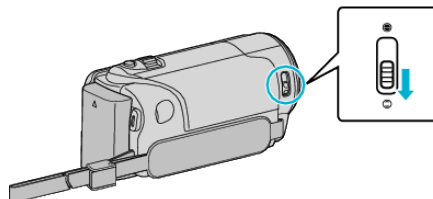

- 2 Open the LCD monitor.

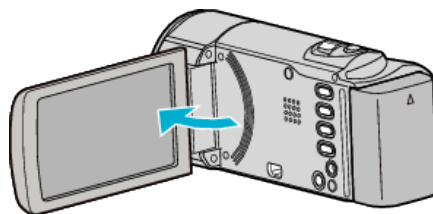

- 3 Select the Manual recording mode.

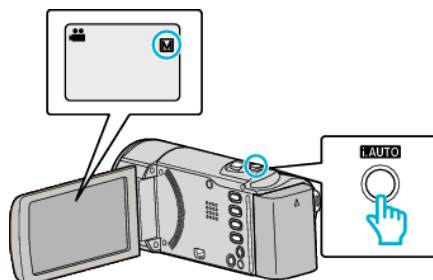

- If the mode is Intelligent Auto, press the i.AUTO button to switch. The mode changes between Intelligent Auto and Manual with every press.

- 4 Start recording.

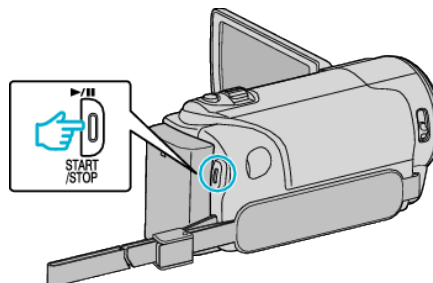

- Press again to stop.

Memo :

- The manual settings are displayed only in the manual mode.

Manual Recording Menu

The following items can be set.

Name	Description
SCENE SELECT	<ul style="list-style-type: none"> Recordings that suit the shooting conditions can be performed easily. "Scene Selection" (☞ p. 25)
FOCUS	<ul style="list-style-type: none"> Use manual focus if the subject is not focused automatically. "Adjusting Focus Manually" (☞ p. 26)
BRIGHTNESS ADJUST	<ul style="list-style-type: none"> Overall brightness on the screen can be adjusted. Use this when recording in a dark or bright location. "Adjusting Brightness" (☞ p. 27)
WHITE BALANCE	<ul style="list-style-type: none"> Overall color on the screen can be adjusted. Use this when the color on the screen appears differently from the actual color. "Setting White Balance" (☞ p. 28)
BACKLIGHT COMP.	<ul style="list-style-type: none"> Corrects the image when the subject appears dark due to backlight. Use this when shooting against the light. "Setting Backlight Compensation" (☞ p. 29)
TELE MACRO	<ul style="list-style-type: none"> Use this to take close-up (macro) shots of the subject. "Taking Close-up Shots" (☞ p. 30)

Scene Selection

Common scenes that are often encountered can be recorded with the most suitable settings.

Memo :

To select/move cursor towards up/left or down/right, press the button UP/< or DOWN/>.

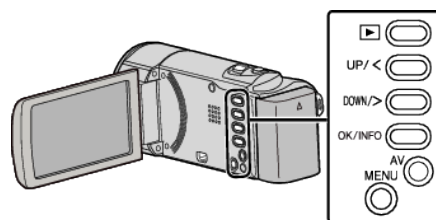

1 Press MENU.

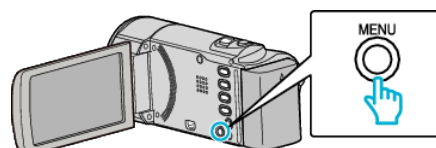

2 Select "MANUAL SETTING" and press OK.

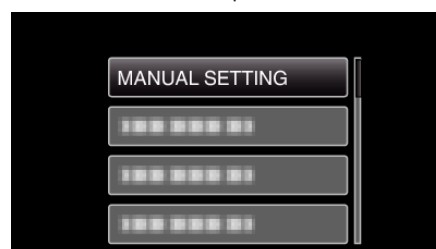



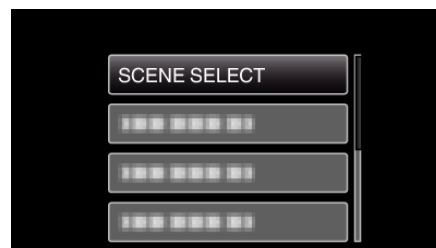

3 Select "SCENE SELECT" and press OK.

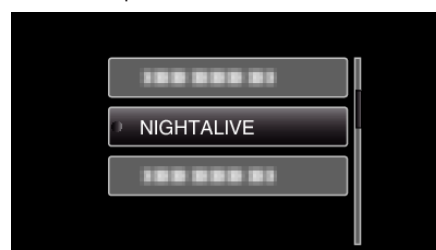

4 Select the scene and press OK.

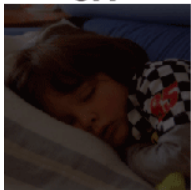
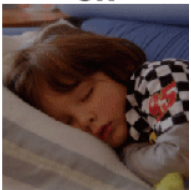

*The image is only an impression.

Setting	Effect
 NIGHTALIVE	Increases gain and brightens the scene automatically using a slow shutter when the surrounding is dark. To prevent camera shake, use a tripod. <div style="display: flex; justify-content: space-around;"> <div style="text-align: center;"> <p>OFF</p>  </div> <div style="text-align: center;"> <p>ON</p>  </div> </div>
 SPOTLIGHT	Prevents the human subject from appearing too bright under light. <div style="display: flex; justify-content: space-around;"> <div style="text-align: center;"> <p>OFF</p>  </div> <div style="text-align: center;"> <p>ON</p>  </div> </div>

Adjusting Focus Manually

Set this when the focus is not clear in Intelligent Auto or when manual focusing is desired.

Memo :

To select/move cursor towards up/left or down/right, press the button UP/< or DOWN/>.

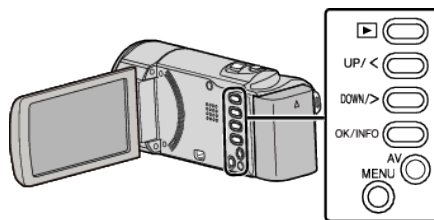

1 Press MENU.

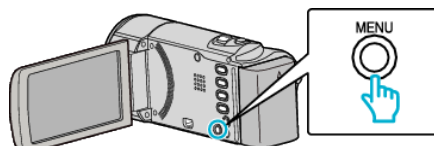

2 Select "MANUAL SETTING" and press OK.

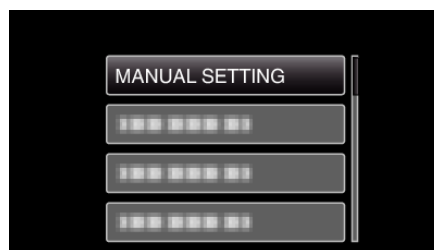

3 Select "FOCUS" and press OK.

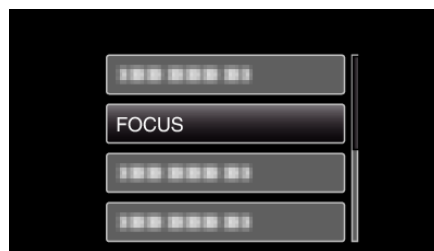

4 Select "MANUAL" and press OK.

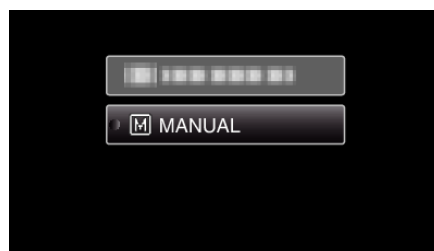

5 Adjust the focus with the UP/< and DOWN/> buttons.



- Press UP/< to focus on a distant subject.
- Press DOWN/> to focus on a near subject.

6 Press OK to confirm.

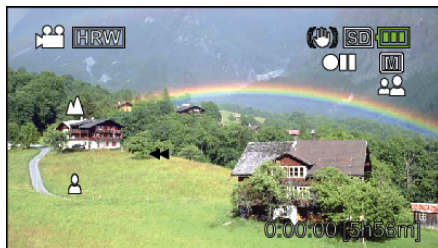
**Memo :**

- A subject that is focused at the telephoto (T) end remains in focus when it is zoomed out to the wide angle (W) end.

Adjusting Brightness

You can adjust the brightness to your preferred level.

Memo :

To select/move cursor towards up/left or down/right, press the button UP/< or DOWN/>.

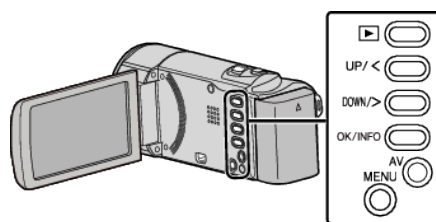

- 1 Press MENU.

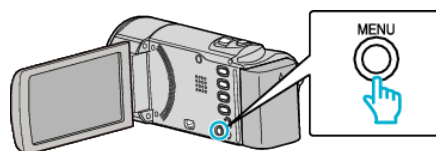

- 2 Select "MANUAL SETTING" and press OK.

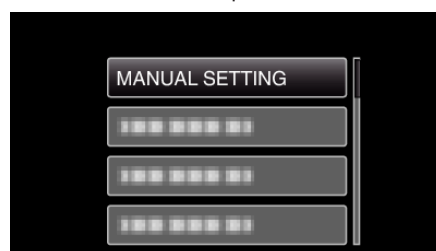

- 3 Select "BRIGHTNESS ADJUST" and press OK.

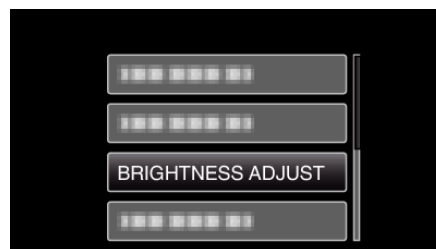

- 4 Select "MANUAL" and press OK.

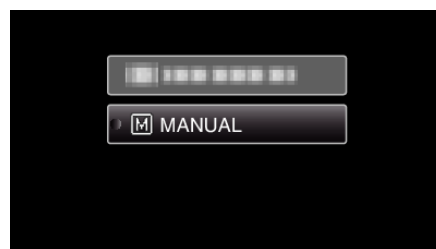

- 5 Select the brightness value with the UP/< and DOWN/> buttons.



- Compensation range during video recording: -6 to +6
 - Press UP/< to increase the brightness.
 - Press DOWN/> to decrease the brightness.
- 6 Press OK to confirm.

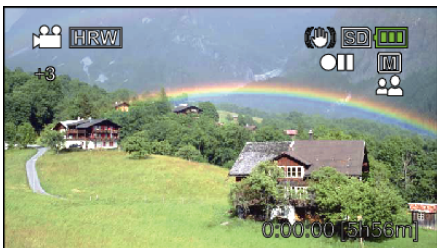

Setting White Balance

You can set the color tone to suit the light source.

Memo :

To select/move cursor towards up/left or down/right, press the button UP/< or DOWN/>.

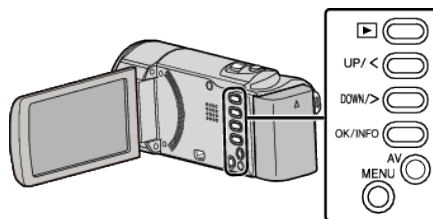

1 Press MENU.

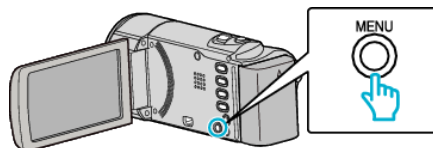

2 Select "MANUAL SETTING" and press OK.

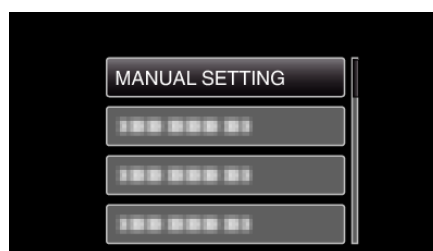

3 Select "WHITE BALANCE" and press OK.

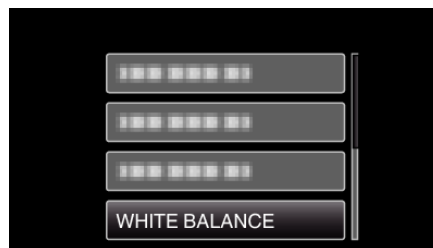

4 Select the white balance setting and press OK.

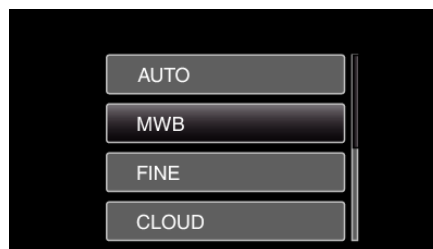

Setting	Details
AUTO	Adjusts automatically to the natural colors.
MWB	Use this when the problem of unnatural colors is not resolved.
FINE	Set this when shooting outdoors on a sunny day.
CLOUD	Set this when shooting on a cloudy day or inside a shade.
HALOGEN	Set this when shooting under illumination such as a video light.

Using MWB

1 Hold a sheet of plain white paper in front of the lens so that the white paper fills the screen.

- 2 Select "MWB" and keep pressing OK.
 - The cursor blinks.
- 3 Release OK after the menu disappears.

Setting Backlight Compensation

You can correct the image when the subject appears too dark due to backlight.

Memo : _____
 To select/move cursor towards up/left or down/right, press the button UP/< or DOWN/>.

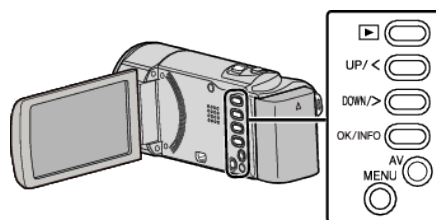

- 1 Press MENU.

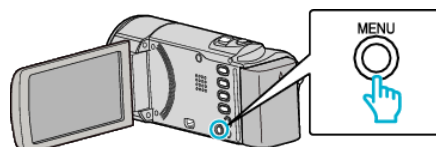

- 2 Select "MANUAL SETTING" and press OK.

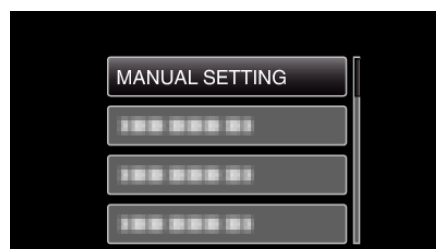

- 3 Select "BACKLIGHT COMP." and press OK.

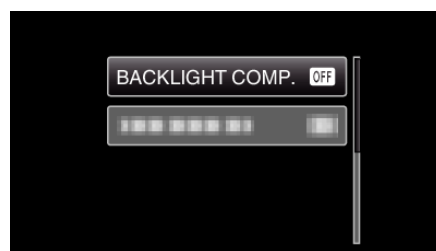

- 4 Select "ON" and press OK.

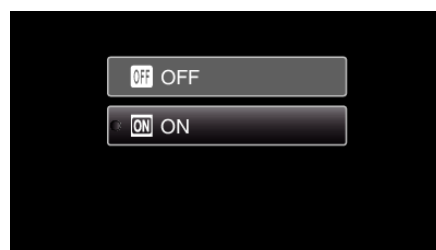

Taking Close-up Shots

You can take close-up shots of an object using the tele macro function.



*The image is only an impression.

Memo :

To select/move cursor towards up/left or down/right, press the button UP/< or DOWN/>.

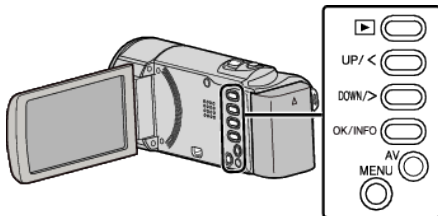

1 Press MENU.

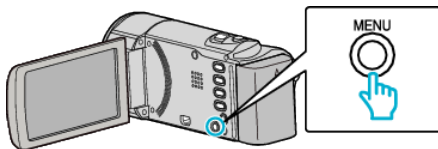

2 Select "MANUAL SETTING" and press OK.

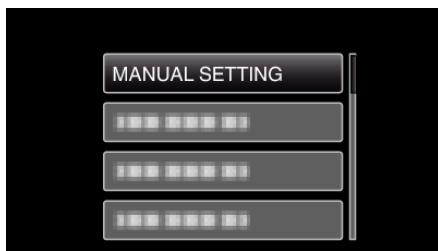

3 Select "TELE MACRO" and press OK.



4 Select "ON" and press OK.

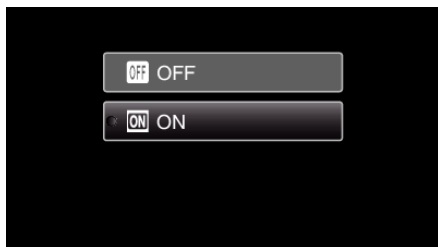

Caution :

- When you are not taking close-up shots, set "TELE MACRO" to "OFF". Otherwise, the image may be blur.

Setting	Details
OFF	Enables close-up shots up to 1 m at the telephoto (T) end. Enables close-up shots up to 5 cm at the wide angle (W) end.
ON	Enables close-up shots up to 50 cm at the telephoto (T) end. Enables close-up shots up to 5 cm at the wide angle (W) end.

Reducing Camera Shake

When the image stabilizer is set, camera shake during recording can be effectively reduced.

Memo : _____
 To select/move cursor towards up/left or down/right, press the button UP/< or DOWN/>.

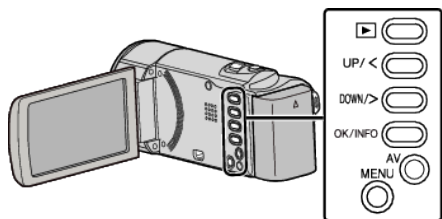

1 Press MENU.

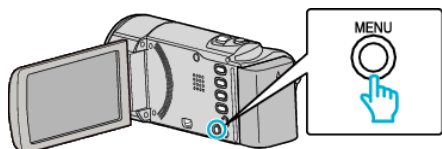

2 Select "DIS" (image stabilizer) and press OK.

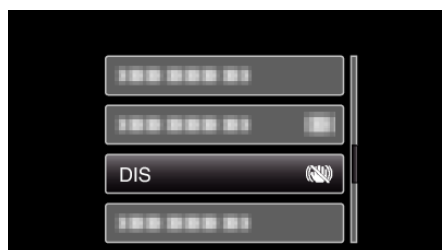

3 Select "ON" or "ON (AIS)" to activate the image stabilizer and press OK.



Display	Setting
OFF	Deactivates image stabilizer.
ON	Reduces camera shake under normal shooting conditions.
ON (AIS)	Reduces camera shake more effectively when shooting bright scenes on the wide angle end. Only on the wide angle end (approx. 5x).

Memo : _____

- It is recommended to set the image stabilizer to "OFF" when shooting a subject of little movement with the unit on a tripod.
- Complete stabilization may not be possible if camera shake is excessive.
- This setting is effective for video recording only.

Capturing Human Subjects Clearly (Face Detection AE/AF)

"FACE PRIORITY AE/AF" automatically adjusts the detected face with appropriate focus and brightness.

Memo : _____
 To select/move cursor towards up/left or down/right, press the button UP/< or DOWN/>.

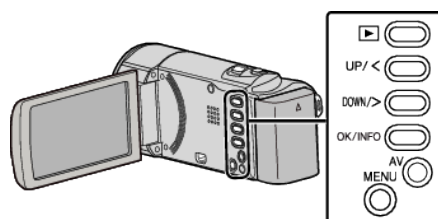

1 Press MENU.

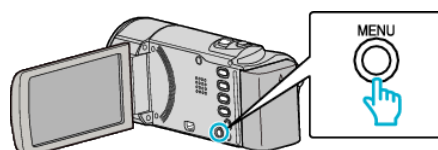

2 Select "FACE PRIORITY AE/AF" and press OK.

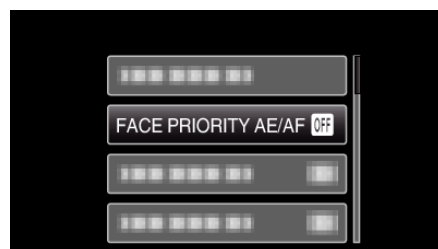

3 Select "ON" and press OK.

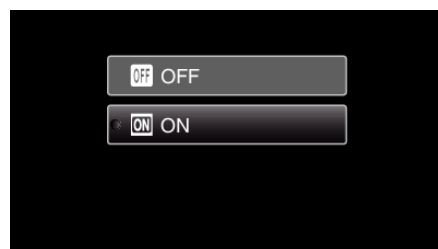

4 Point the camera toward the human subject.



- A frame appears around the face of the subject, and the focus and brightness are automatically adjusted.
- If multiple faces are detected, the face that is closest to the camera will be focused.

5 Start recording.

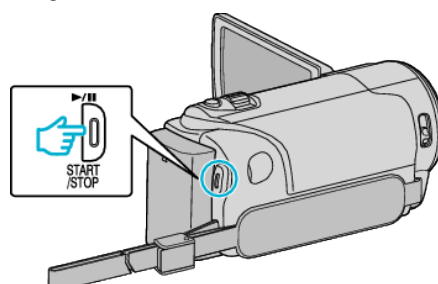

Caution :

- When “FACE PRIORITY AE/AF” is set to “ON”, the following settings will change.
 - If “SCENE SELECT” is set to “SPOTLIGHT”, it will be switched to “OFF”.
 - If “FOCUS” is set to “MANUAL”, it will be switched to “AUTO”.
 - If “BACKLIGHT COMP.” is set to “ON”, it will be switched to “OFF”.
- When the following settings are made, “FACE PRIORITY AE/AF” will switch to “OFF”.
 - When “SCENE SELECT” is set to “SPOTLIGHT”
 - When “FOCUS” is set to “MANUAL”
 - When “BACKLIGHT COMP.” is set to “ON”

Memo :

- The camera is able to detect up to 16 faces.
- Some faces may not be detected depending on the shooting environment.
- If appropriate results cannot be obtained, record with “FACE PRIORITY AE/AF” set to “OFF”.

Recording at Intervals (TIME-LAPSE RECORDING)

Enables the changes of a scene that occur slowly over a long period to be shown within a short time by taking frames of it at a certain interval. This is useful for making observations such as the opening of a flower bud.

Memo :

To select/move cursor towards up/left or down/right, press the button UP/< or DOWN/>.

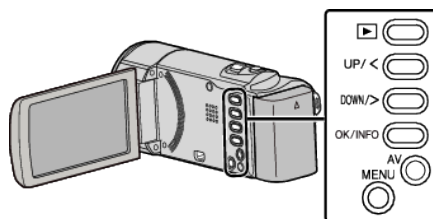

1 Press MENU.

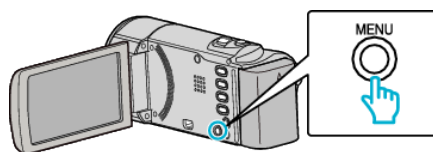

2 Select “TIME-LAPSE RECORDING” and press OK.

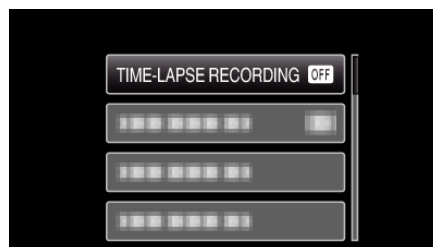

3 Select a recording interval (1 to 80 seconds) and press OK.



- The greater the number of seconds, the longer the recording interval.

4 Start recording.

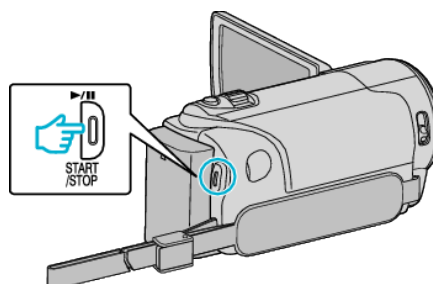

- A frame is taken at intervals of the selected period.
- When the recording interval is set to “20SEC INTERVAL” or higher, this unit switches to the power-saving mode between recordings. At the next point to record, the power-saving mode will be turned off and recording will start automatically.
- Press the START/STOP button again to stop recording.

Indications During Time-Lapse Recording

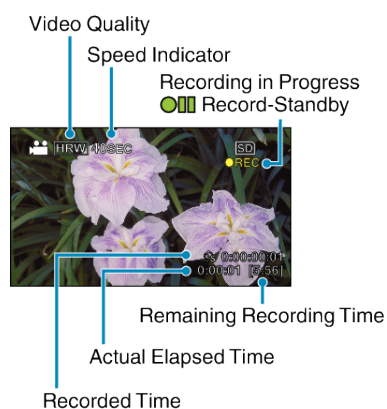

Display	Description
Speed Indicator	Displays the recording interval that is set.
Video Quality	Displays the icon of the video quality that is set.
Remaining Recording Time	Remaining time left to record with the currently selected video quality.
Recording in Progress	Appears when video recording is in progress. When in the power-saving mode, it blinks.
Record-Standby	Appears when video recording is paused.
Actual Elapsed Time	Displays the actual elapsed time after recording starts.
Recorded Time	Displays the actual recorded time of the video. Recorded time increases in units of frames.

Time-Lapse Setting

The greater the number of seconds, the longer the recording interval.

Setting	Details
OFF	Deactivates the function.
1SEC INTERVAL	Takes a frame at 1-second intervals. Recorded videos will be played back at 30 times speed.
2SEC INTERVAL	Takes a frame at 2-second intervals. Recorded videos will be played back at 60 times speed.
5SEC INTERVAL	Takes a frame at 5-second intervals. Recorded videos will be played back at 150 times speed.
10SEC INTERVAL	Takes a frame at 10-second intervals. Recorded videos will be played back at 300 times speed.
20SEC INTERVAL	Takes a frame at 20-second intervals. Recorded videos will be played back at 600 times speed.
40SEC INTERVAL	Takes a frame at 40-second intervals. Recorded videos will be played back at 1 200 times speed.
80SEC INTERVAL	Takes a frame at 80-second intervals. Recorded videos will be played back at 2 400 times speed.

Caution :

- Audio cannot be recorded during time-lapse recording.
- Zooming, face priority AE/AF, and image stabilizer are not available in time-lapse recording.
- When recording is stopped with the recorded time less than "0:00:00:14", the video will not be saved.

Memo :

- Settings of time-lapse recording are not saved when the power is turned off.
- Recording stops automatically 99 hours after it is started.
- Make use of a tripod and AC adapter for time-lapse recordings with long intervals.
It is also recommended to fix the focus and white balance manually.

"Tripod Mounting" (☞ p. 19)

"Adjusting Focus Manually" (☞ p. 26)

"Setting White Balance" (☞ p. 28)

Recording Automatically by Sensing Movements (AUTO REC)

This function enables the unit to record automatically by sensing the changes in subject's movement (brightness) within the red frame displayed on the LCD monitor. (AUTO REC)

Memo : _____

To select/move cursor towards up/left or down/right, press the button UP/< or DOWN/>.

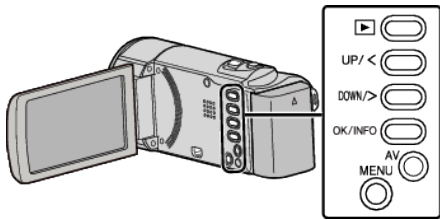

1 Compose the picture according to the subject.

- Adjust the angle of view with the zoom, etc.

2 Press MENU.

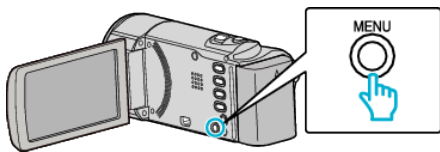

3 Select "AUTO REC" and press OK.

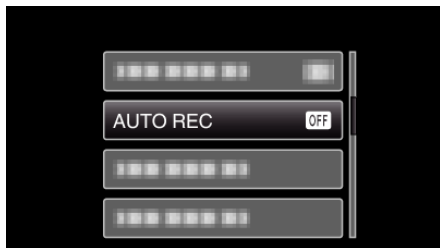

4 Select "ON" and press OK.

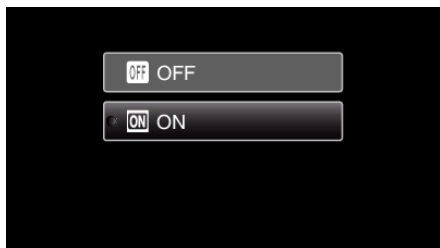

5 Recording starts automatically when the subject within the red frame moves.



- A red frame appears 2 seconds after the menu display disappears.
- For video recording, recording continues while there are still movements of the subject (changes in brightness) within the red frame. When there are no more movements of the subject (changes in brightness) within the red frame, recording will stop in 5 seconds.
- To stop video recording manually, press the START/STOP button. However, as the "AUTO REC" setting remains at "ON" even after the video recording is stopped, recording starts again when movements of the subject (changes in brightness) are detected within the red frame. To cancel "AUTO REC", set it to "OFF".

- The only manual recording setting available is "TELE MACRO". The rest are all set to "AUTO".
- Digital zoom and image stabilizer are not available after "AUTO REC" is set.
- "AUTO REC" cannot be used together with "TIME-LAPSE RECORDING". When both are set, priority is given to "TIME-LAPSE RECORDING".
- The auto power off and power-saving modes are not available after "AUTO REC" is set.

Memo : _____

- Recording stops when there are no changes for 5 seconds during video recording.
- Recording may not start when the movements of the subject within the red frame are too fast or the changes in brightness are too small.
- Recording may start due to changes in brightness even if there is no movement within the red frame.
- While zooming, recording cannot be started.

Caution : _____

Remaining Recording Time/Battery Power

You can check the remaining video recording time on the SD card as well as the remaining battery power.

Memo :

To select/move cursor towards up/left or down/right, press the button UP/< or DOWN/>.

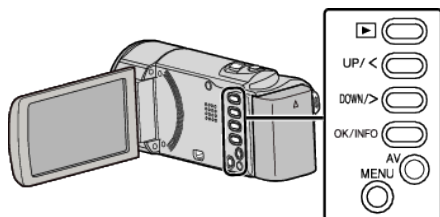

- 1 Open the LCD monitor.

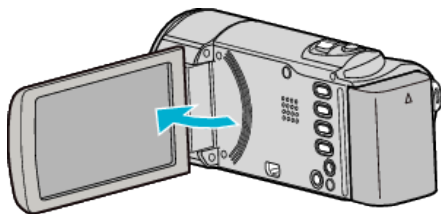

- 2 Press OK/INFO.

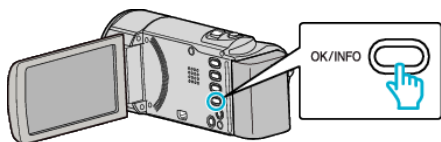

- 3 Display the remaining recording time.



- To display the remaining battery power, press OK/INFO.
- To exit the display, press MENU.

- 4 Display the remaining battery power.

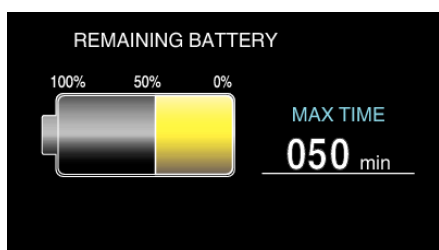

- To exit the display, press OK/INFO.
- Remaining battery power will not be displayed when the AC adapter is connected.

Memo :

- You can change the video quality from the remaining recording time display. Select the video quality with the UP/< and DOWN/> buttons and press OK.

Recording

Approximate Video Recording Time

Quality	SDHC/SDXC Card					
	4 GB	8 GB	16 GB	32 GB	48 GB	64 GB
HR/HRW	1 h	2 h	4 h	8 h 10 m	12 h 10 m	16 h 30 m
SR/SRW	2 h	4 h 10 m	8 h 30 m	17 h 20 m	25 h 30 m	34 h 30 m

- The actual recording time may shorten depending on the shooting environment.

Approximate Recording Time (Using Battery)

Battery Pack	Actual Recording Time	Continuous Recording Time
BN-VG107E (Supplied)	40 m (35 m)	1 h 5 m (1 h)
BN-VG114E	1 h 15 m (1 h 5 m)	2 h 10 m (1 h 55 m)
BN-VG121E	1 h 55 m (1 h 40 m)	3 h 15 m (2 h 55 m)
BN-VG138E	3 h 20 m (3 h)	5 h 45 m (5 h 20 m)

- The above are values when "MONITOR BRIGHTNESS" is set to "3" (standard).
(): Values when "MONITOR BRIGHTNESS" is set to "4" (brighter)
- The actual recording time may be shorter if zooming is used or if recording is stopped repeatedly.
(It is recommended to prepare battery packs ready for three times the expected recording time.)

Playing Back Videos

You can select and play back the recorded videos from an index screen (thumbnail display).

- 1 Select the playback mode.

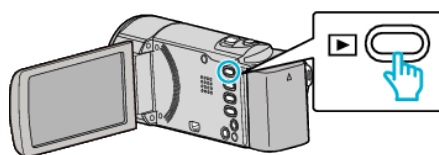

- Press again to return to the recording mode.

- 2 Select the desired video and press OK or .

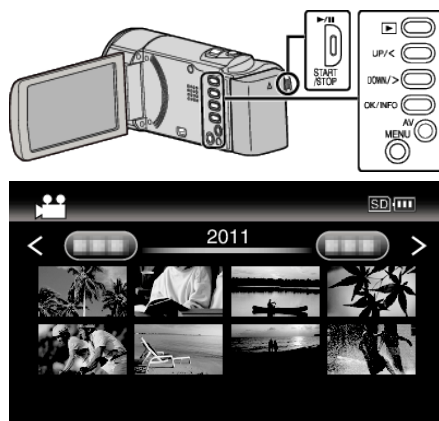

- Press the button to stop (pause) playback.
- To return to the index screen, slide along the (zoom) lever while playback is paused.
- To move to the next page on the index screen, slide along the (zoom) lever.

Operation Buttons/Levers for Video Playback

During Index Screen Display

Operation Button/Lever	Description
UP/< DOWN/>	Select/move cursor
OK/INFO 	Play back video
Zoom T/W	Move to the next or previous page

During Video Playback

Operation Button/Lever	During Video Playback	During Video Pause
	Pause	Playback
Zoom	-	Stop (returns to thumbnail display)
Zoom T / Vol.+	Increases volume level	-
Zoom W / Vol.-	Decreases volume level	-
UP/<*	Reverse search	Frame-by-frame playback in reverse direction
DOWN/>*	Forward search	Frame-by-frame playback in forward direction

*Press and hold to start slow playback.

Caution :

- Make a backup of important recorded data.
It is recommended to copy your important recorded data to a DVD or other recording media for storage.
JVC will not be responsible for any lost data.

Adjusting the Volume of Videos

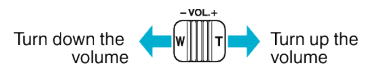

Checking the Recording Date and Other Information

You can display the recording date and duration of the selected file.

- 1 Pause playback.
- 2 Press OK/INFO.

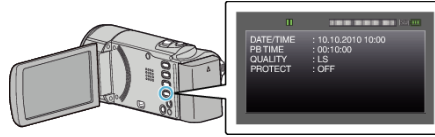

Connecting to and Viewing on TV

You can connect this unit to a TV for playback. The image quality on TV varies with the type of TV and the connecting cable. Select the connector that best suits your TV.

- Refer also to the instruction manual of the TV in use.
- “Connecting via the AV Connector” (☞ p. 39)

Unnatural Displays on TV

Trouble	Action
Images are projected vertically on the TV.	<ul style="list-style-type: none"> • Set “VIDEO OUTPUT” in the “CONNECTION SETTINGS” menu to “4:3”. • “VIDEO OUTPUT” (☞ p. 67)
Images are projected horizontally on the TV.	<ul style="list-style-type: none"> • Adjust the TV's screen accordingly.

Connecting via the AV Connector

By connecting the supplied AV cable to the AV connector, videos can be played back on a TV.

- Refer also to the instruction manual of the TV in use.

Memo :

To select/move cursor towards up/left or down/right, press the button UP/< or DOWN/>.

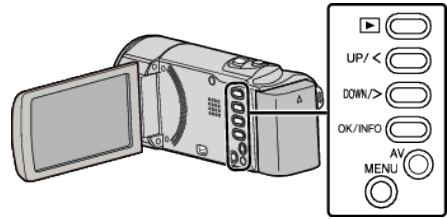

- 1 Connect to a TV.

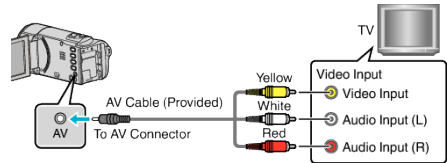

- 2 Connect the AC adapter to this unit.

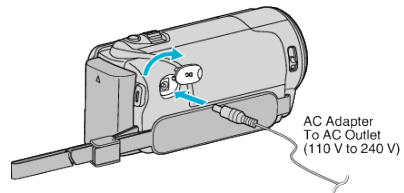

- This unit powers on automatically when the AC adapter is connected.

- 3 Press the external input button on the TV to switch to the input from this unit via the connected connector.

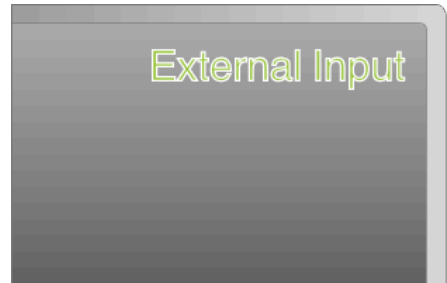

- 4 Play back a file.



“Playing Back Videos” (☞ p. 37)

Memo :

- To play back with date/time display, set “DISPLAY ON TV” in the “CONNECTION SETTINGS” menu to “ON”.

“DISPLAY ON TV” (☞ p. 67)

- For questions about the TV or method of connection, contact your TV's manufacturer.

Deleting Unwanted Files

Delete unwanted videos when the space in the recording media is running out.

The capacity of the recording media can be restored after deleting the files.

“Deleting the Currently Displayed File” (p. 40)

“Deleting Selected Files” (p. 41)

“Deleting All Files” (p. 42)

Memo :

- Deleted files cannot be restored.
- Files that are protected cannot be deleted.
Release protection before deleting the file.

“Protecting Files” (p. 42)

- Be sure to back up important files on a computer.

“Backing Up All Files” (p. 48)

Deleting the Currently Displayed File

Deletes the currently displayed file.

Memo :

To select/move cursor towards up/left or down/right, press the button UP/< or DOWN/>.

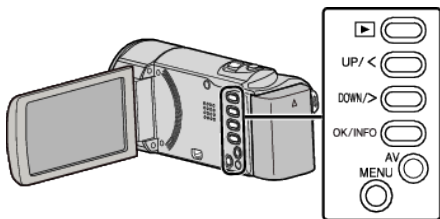

Caution :

- Deleted files cannot be restored.

1 Select the playback mode.

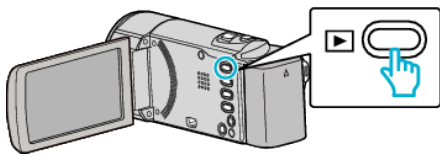

2 Press MENU.

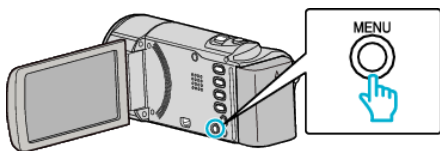

3 Select “DELETE” and press OK.

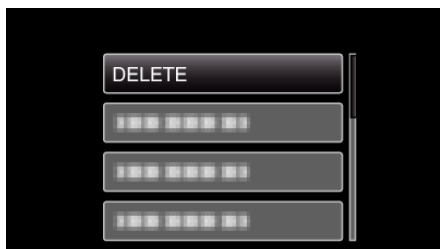

4 Select “CURRENT” and press OK.

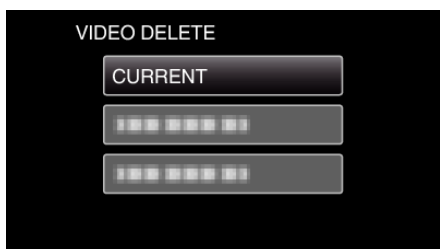

5 Check that it is the file to delete, select “YES” and press OK.

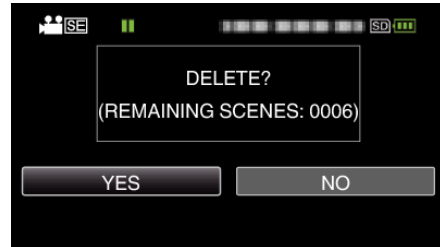

- The file to delete appears on this screen.
- Press the zoom lever to select the previous or next file.
- After deleting, press MENU.

Memo :

- Files that are protected cannot be deleted.
Release protection before deleting the file.

“Protecting Files” (p. 42)

Deleting Selected Files

Deletes the selected files.

Memo : _____

To select/move cursor towards up/left or down/right, press the button UP/< or DOWN/>.

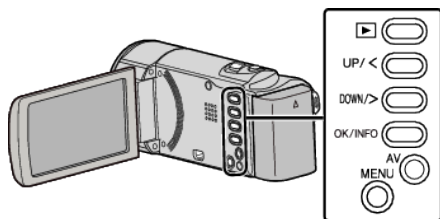

Caution : _____

- Deleted files cannot be restored.

1 Select the playback mode.

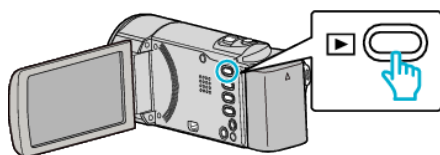

2 Press MENU.

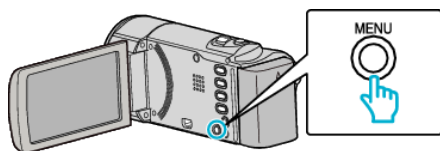

3 Select "DELETE" and press OK.

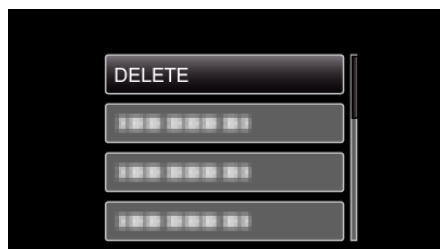

4 Select "FILE SELECT" and press OK.

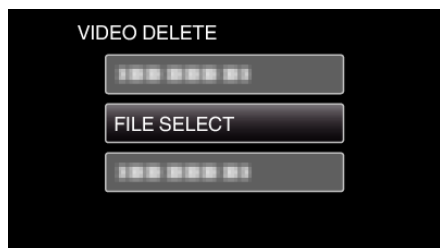

5 Select the files to delete and press OK.



- Press UP/< or DOWN/> to select files.
- A delete mark appears on the selected file. To remove the delete mark, press OK again.
- To move to the next page on the index screen, slide along the (zoom) lever.

6 After selecting all the files to delete, press MENU.

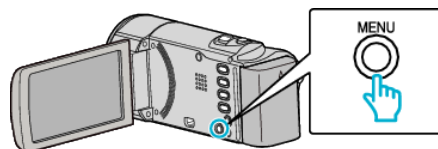

7 Select "EXECUTE" and press OK.

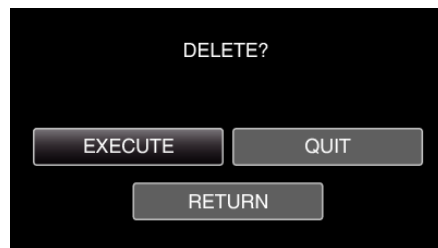

- After deleting, press OK.
- To cancel the deletion, select "QUIT" and press OK.
- To return to the previous screen, select "RETURN" and press OK.

Memo : _____

- Files that are protected cannot be deleted. Release protection before deleting the file.

"Protecting Files" (p. 42)

Deleting All Files

Deletes all files.

Memo : _____

To select/move cursor towards up/left or down/right, press the button UP/< or DOWN/>.

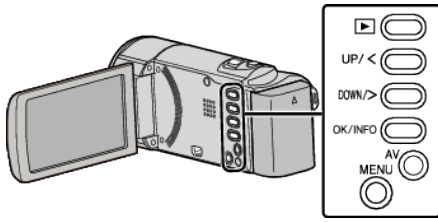

Caution : _____

- Deleted files cannot be restored.

1 Select the playback mode.

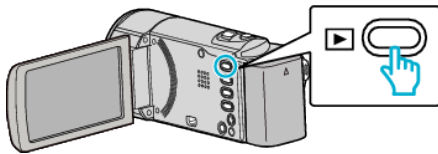

2 Press MENU.

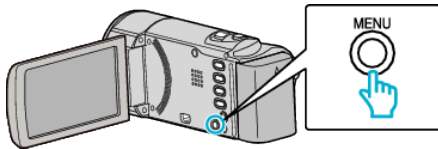

3 Select "DELETE" and press OK.

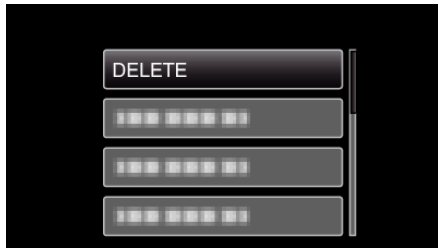

4 Select "DELETE ALL" and press OK.

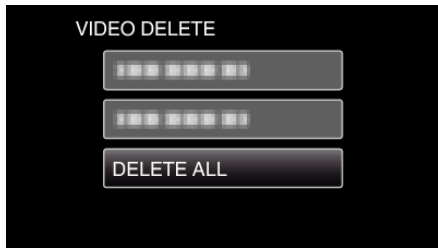

5 Select "YES" and press OK.



- After deleting, press OK.
- To cancel the deletion, select "NO" and press OK.

Memo : _____

- Files that are protected cannot be deleted.
Release protection before deleting the file.

"Protecting Files" (p. 42)

Protecting Files

Prevent important videos from being deleted accidentally by protecting them.

"Protecting the Currently Displayed File" (p. 42)

"Protecting Selected Files" (p. 43)

"Protecting All Files" (p. 44)

"Releasing Protection of All Files" (p. 44)

Caution : _____

- When the recording media is formatted, even the protected files will be deleted.

Protecting the Currently Displayed File

Protects or releases protection of the currently displayed file.

Memo : _____

To select/move cursor towards up/left or down/right, press the button UP/< or DOWN/>.

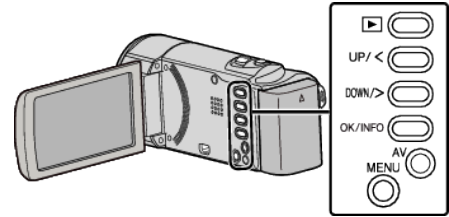

1 Select the playback mode.

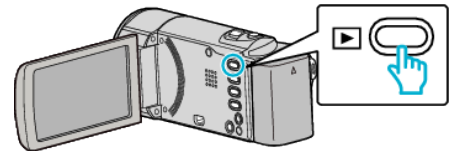

2 Press MENU.

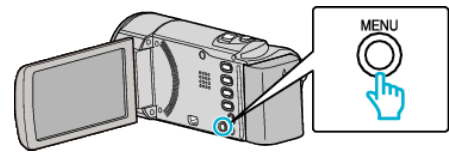

3 Select "PROTECT/CANCEL" and press OK.

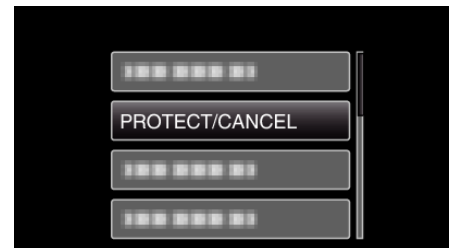

4 Select "CURRENT" and press OK.

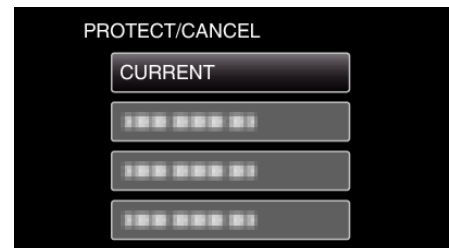

5 Check that it is the file to protect, select "YES" and press OK.



- The file to protect appears on this screen.
- To cancel the protection, select "NO" and press OK.
- Press the zoom lever to select the previous or next file.
- After setting, press OK.
- To exit the screen, press MENU.

Protecting Selected Files

Protects or releases protection of the selected files.

Memo :

To select/move cursor towards up/left or down/right, press the button UP/< or DOWN/>.

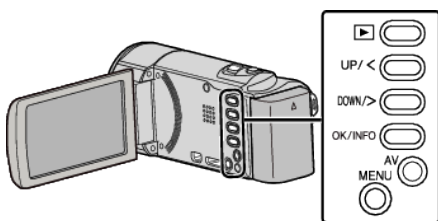

- 1 Select the playback mode.

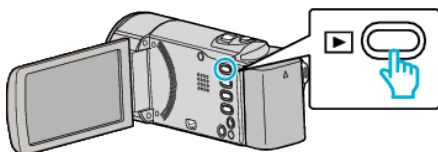

- 2 Press MENU.

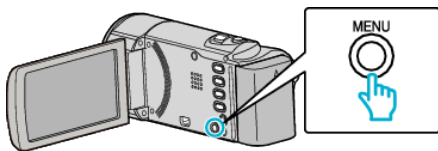

- 3 Select "PROTECT/CANCEL" and press OK.

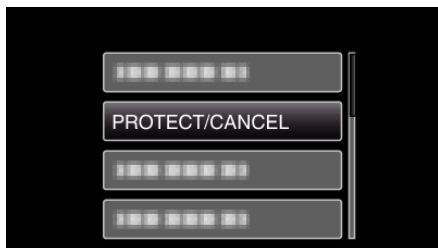





- 4 Select "FILE SELECT" and press OK.



- To exit, press MENU, select "YES" and press OK.

- 5 Select the files to protect or release protection of and press OK.



- A protect mark  appears on the selected file. To remove the protect mark , press OK again.
- To move to the next page on the index screen, slide along the  (zoom) lever.
- If the transmission mode of Eye-Fi Helper is set to "Share Selected Files Only" or "Transmit Selected Files Only",  will be displayed.

- 6 After selecting all the files to protect or release protection of, press MENU.

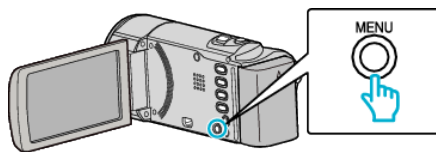

- 7 Select "YES" and press OK.

- To cancel the protection, select "NO" and press OK.

Protecting All Files

Protects all files.

Memo :

To select/move cursor towards up/left or down/right, press the button UP/< or DOWN/>.

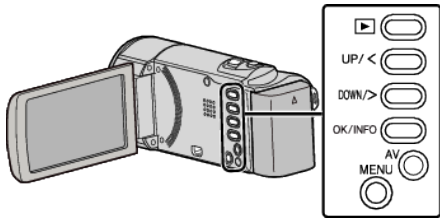

1 Select the playback mode.

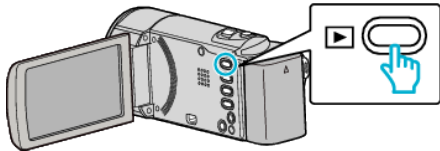

2 Press MENU.

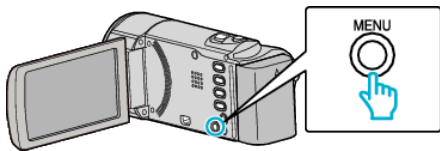

3 Select "PROTECT/CANCEL" and press OK.

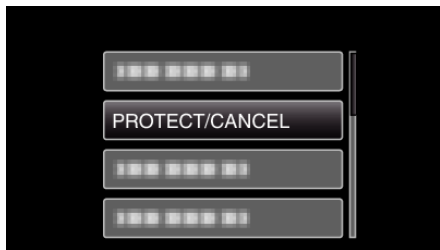

4 Select "PROTECT ALL" and press OK.



5 Select "YES" and press OK.

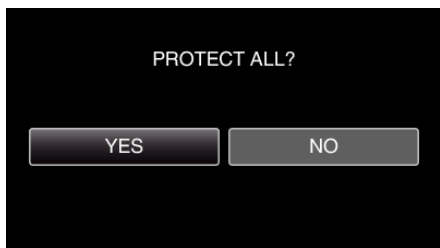

- After setting, press OK.

Releasing Protection of All Files

Releases protection of all files.

Memo :

To select/move cursor towards up/left or down/right, press the button UP/< or DOWN/>.

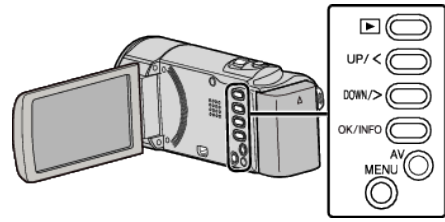

1 Select the playback mode.

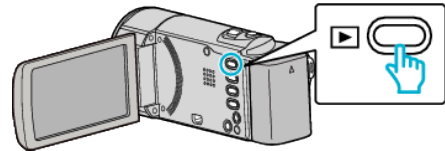

2 Press MENU.

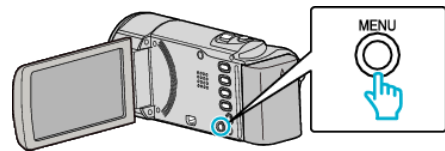

3 Select "PROTECT/CANCEL" and press OK.

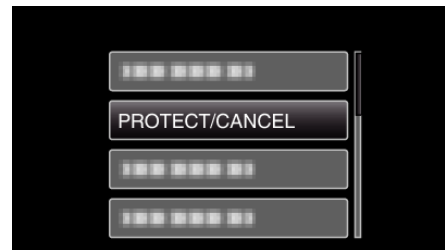

4 Select "CANCEL ALL" and press OK.

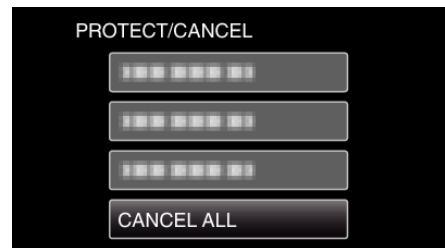

5 Select "YES" and press OK.



- After protection is released, press OK.

Dubbing Files by Connecting to a DVD Recorder or VCR

You can dub videos in standard quality by connecting to a DVD recorder or VCR.

- Refer also to the instruction manuals of the TV, DVD recorder, VCR, etc.

1 Connect to a VCR/DVD recorder.

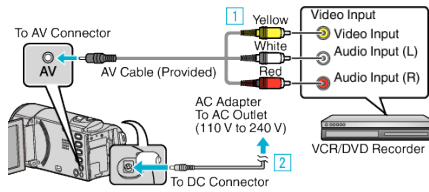

- 1 Connect using the provided AV cable.
- 2 Connect the AC adapter to this unit.

- This unit powers on automatically when the AC adapter is connected.
- Be sure to use the supplied JVC AC adapter.

2 Select the playback mode.

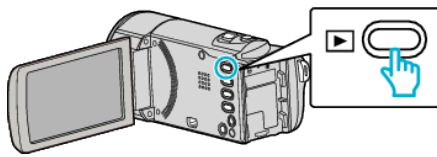

3 Prepare the TV/VCR for recording.

- Switch to a compatible external input.
- Insert a DVD-R or video tape.

4 Prepare this unit for playback.

- Set "VIDEO OUTPUT" in the "CONNECTION SETTINGS" menu to the aspect ratio ("4:3" or "16:9") of the connecting TV.

"VIDEO OUTPUT" (p. 67)

- To include the date during dubbing, set "DISPLAY ON TV" in the "CONNECTION SETTINGS" menu to "ON".
Set "ON-SCREEN DISPLAY" in the playback menu to "ON".

"DISPLAY ON TV" (p. 67)

"ON-SCREEN DISPLAY" (p. 61)

5 Start recording.

- Start playback on this unit and press the record button on the recorder.
- "Playing Back Videos" (p. 37)
- After playback is complete, stop the recording.

Caution :

- File copying by connecting this unit to a DVD writer is not supported.

Creating a Disc Using a Connected Blu-ray Recorder

You can create discs using a Blu-ray recorder by connecting it to this unit using a USB cable.

Memo :

To select/move cursor towards up/left or down/right, press the button UP/< or DOWN/>.

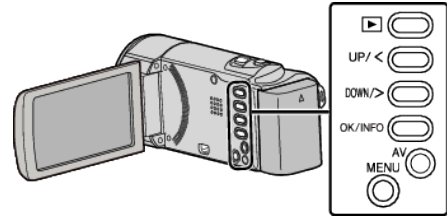

1 Open the LCD monitor.

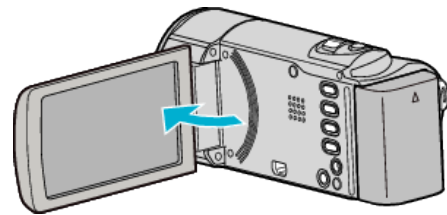

2 Connect to a Blu-ray recorder.

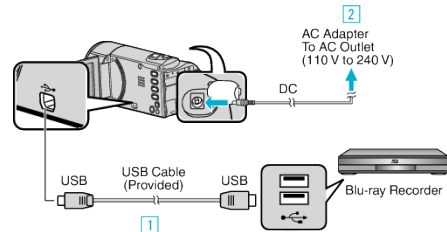

- 1 Connect using the provided USB cable.
- 2 Connect the AC adapter to this unit.

- This unit powers on automatically when the AC adapter is connected.
- Be sure to use the supplied JVC AC adapter.
- 3 The "SELECT DEVICE" menu appears.

3 Select "CONNECT TO OTHER" and press OK.



4 Perform dubbing on the Blu-ray recorder.

- Refer also to the instruction manual of the Blu-ray recorder.

Memo :

- Refer also to the following website.

<http://www.jvc-victor.co.jp/dvmain/>

Copying to Windows PC

You can copy files to a computer using the provided software.

DVDs can also be created using the computer's DVD drive.

If the provided software is not installed, this unit will be recognized as an external storage when connected.

Memo :

- To record to discs, a recordable DVD drive is required for the computer in use.

Trouble with Using the Provided Software LoLoScope AX

Customer Support Information

- LoLo Inc. Homepage:

<http://loilo.tv/product/15>

- For details on how to upload to YouTube or how to record videos to discs:

<http://loilo.tv/product/support/22>



Verifying System Requirements (Guideline)

Right-click on “Computer” (or “My Computer”) in the “Start” menu and select “Properties” to check the following items.

Windows Vista/Windows 7

- Refer to the operating instructions found in the animation on the Detailed User Guide.

Windows XP

- Refer to the operating instructions found in the animation on the Detailed User Guide.

	Windows Vista/Windows 7	Windows XP
OS	Windows Vista 32/64-bit Home Basic or Home Premium (Pre-installed versions only) Service Pack 2 Windows 7 32/64-bit Home Premium (Pre-installed versions only)	Windows XP Home Edition or Professional (Pre-installed versions only) Service Pack 3
CPU	Intel Core 2 Duo, CPU 1.6 GHz or higher (Intel Core 2 Duo, CPU 2 GHz or higher recommended)	Intel Core 2 Duo, CPU 1.6 GHz or higher (Intel Core 2 Duo, CPU 2 GHz or higher recommended)
RAM	At least 2 GB	At least 2 GB

Other requirements

Graphic: Intel 945 or higher recommended, NVIDIA GeForce 6000 series or higher recommended, ATI Radeon 9600 or higher recommended

Memo : _____

- If your PC does not meet the above system requirements, operations of the provided software cannot be guaranteed.
- For more information, contact your PC's manufacturer.

Installing the Provided Software

You can display the recorded images in folder bar interface and perform simple editing using the provided software.

- Refer to the operating instructions found in the animation on the Detailed User Guide.

Copying

Backing Up All Files

Before making backup, make sure that enough free space is left in the computer's hard disk (HDD).

Memo : To select/move cursor towards up/left or down/right, press the button UP/< or DOWN/>.

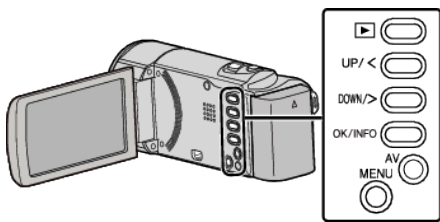

1 Open the LCD monitor.

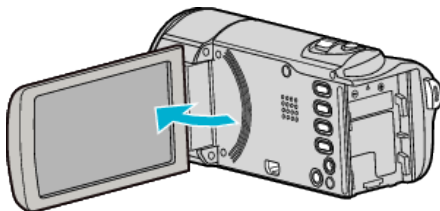

2 Connect the USB cable and the AC adapter.

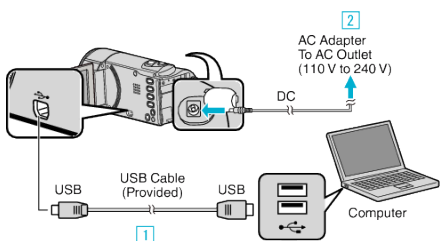

1 Connect using the provided USB cable.

2 Connect the AC adapter to this unit.

- This unit powers on automatically when the AC adapter is connected.
- Be sure to use the supplied JVC AC adapter.
- The provided software LoiLoScope AX starts up on the computer. The subsequent operations are to be performed on the computer.

3 Select the files to back up.

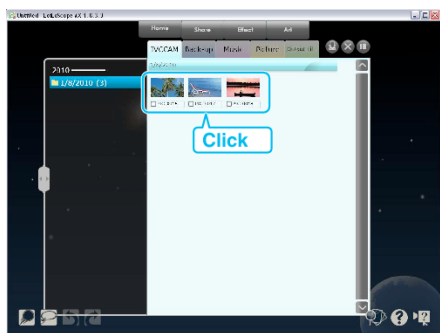

4 Select "Back-up".

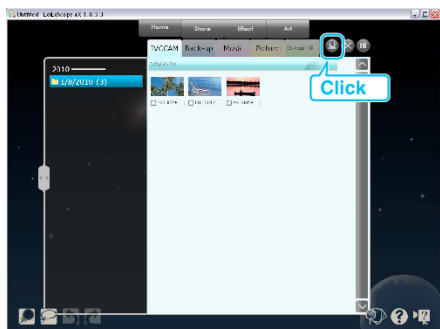

5 Start backup.

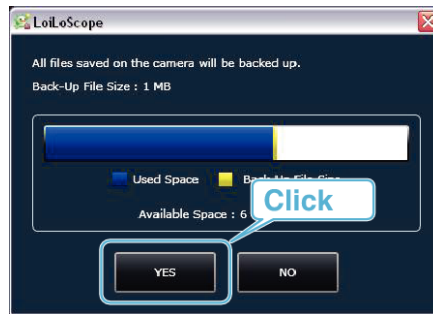

- Backup starts.

Memo :

- Before making backup, load the SD card in which the videos are stored on this unit.
- After backing up your files using the provided software, they cannot be restored to this unit.
- If you encounter any problems with the provided software LoiLoScope AX, please consult the "Customer Support Information".

Homepage	http://loilo.tv/product/15
----------	---

- Delete unwanted videos before making backup. It takes time to back up many videos.

"Deleting Unwanted Files" (p. 40)

Disconnecting this Unit from Computer

1 Click "Safely Remove Hardware and Eject Media".

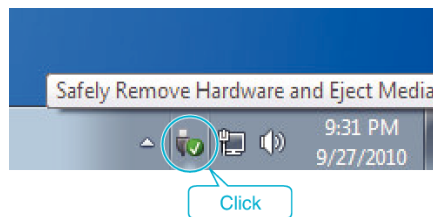

2 Click "Safely Remove USB Mass Storage Device".

3 (For Windows Vista) Click "OK".

4 Disconnect the USB cable and close the LCD monitor.

Organizing Files

After backing up your files, organize them by adding labels such as “Family Trip” or “Athletic Meet”. This is useful not only for creating discs, but for viewing the files too.

Homepage	http://loilo.tv/product/15
----------	---

- 1 Double-click on the LoLoScope AX icon.
 - The provided software starts up.



- 2 Display the files to organize.

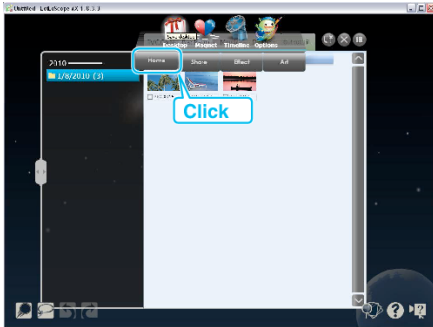

- 3 Create a user list.

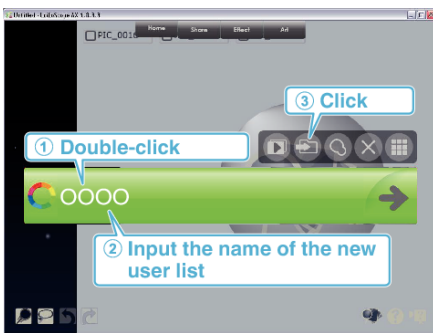
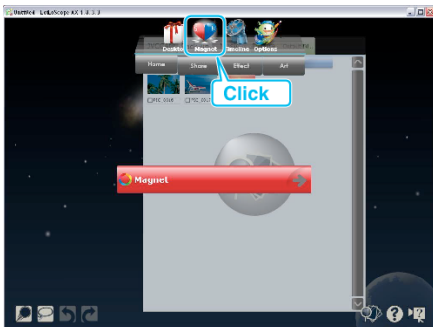

- A new user list is added to the user list library.

- 4 Register files to the created user list.



Memo :

- If you encounter any problems with the provided software LoLoScope AX, please consult the “Customer Support Information”.

Backing Up Files Without Using Provided Software

Copy the files to a computer using the following method.

Memo :

To select/move cursor towards up/left or down/right, press the button UP/< or DOWN/>.

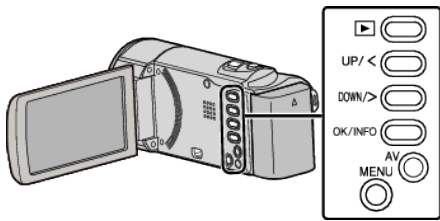

1 Open the LCD monitor.

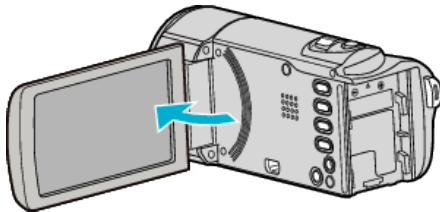

2 Connect the USB cable and the AC adapter.

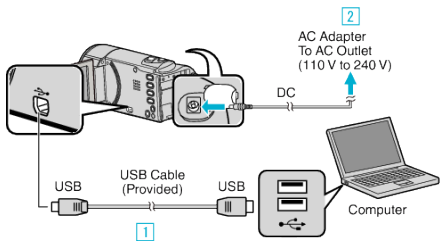

1 Connect using the provided USB cable.

2 Connect the AC adapter to this unit.

- This unit powers on automatically when the AC adapter is connected.
- Be sure to use the supplied JVC AC adapter.

3 The "SELECT DEVICE" menu appears.

3 Select "CONNECT TO PC" and press OK.



- Press UP/< or DOWN/> to move the cursor.

4 Select "PLAYBACK ON PC" and press OK.

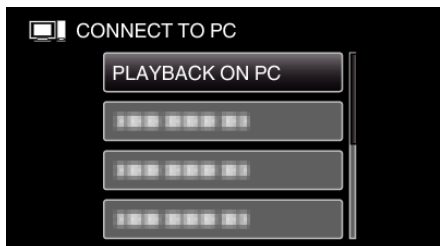

- Press UP/< or DOWN/> to move the cursor.
- To cancel and return to the previous screen, press MENU.
- Close the LoiLoScope AX program, if it starts.
- The subsequent operations are to be performed on the computer.

5 Select "Computer" (Windows Vista) / "My Computer" (Windows XP) / "Computer" (Windows 7) from the "Start" menu, then click on the "JVCCAM_MEM" or "JVCCAM_SD" icon.

- Open the folder with the desired files.
- "List of Files and Folders" (p. 51)

6 Copy the files to any folder in the computer (desktop, etc).

Caution :

- When the folders or files are deleted/moved/renamed in the computer, they cannot be played back on this unit anymore.

Memo :

- To edit/view the files, use a software that supports MP4 SD (video) files.
- The above operations on computer may vary with the system used.

Disconnecting this Unit from Computer

1 Click "Safely Remove Hardware and Eject Media".



2 Click "Safely Remove USB Mass Storage Device".

3 (For Windows Vista) Click "OK".

4 Disconnect the USB cable and close the LCD monitor.

List of Files and Folders

Folders and files are created in the SD card as shown below. They are created only when necessary.

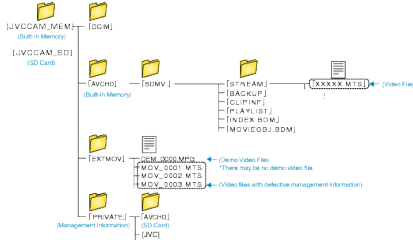

Caution :

- When the folders or files are deleted/moved/rename in the computer, they cannot be played back on this unit anymore.

Copying to Mac Computer

Copy the files to a Mac computer using the following method.

Memo :

To select/move cursor towards up/left or down/right, press the button UP/< or DOWN/>.

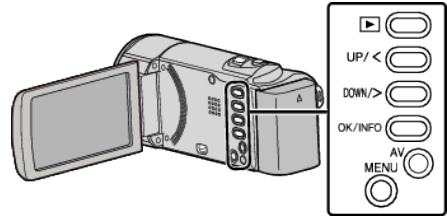

1 Open the LCD monitor.

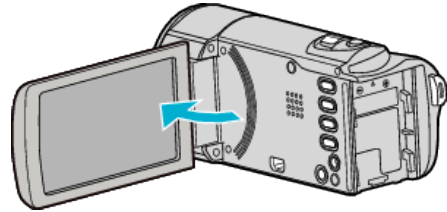

2 Connect the USB cable and the AC adapter.

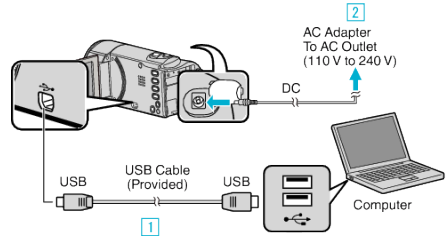

1 Connect using the provided USB cable.

2 Connect the AC adapter to this unit.

- This unit powers on automatically when the AC adapter is connected.
- Be sure to use the supplied JVC AC adapter.
- 3 The “SELECT DEVICE” menu appears.
- The provided software is not required for this process.

3 Select “CONNECT TO PC” and press OK.



- Press UP/< or DOWN/> to move the cursor.

4 Select “PLAYBACK ON PC” and press OK.

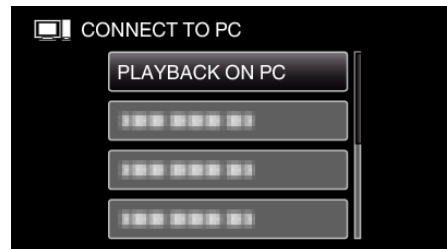

- Press UP/< or DOWN/> to move the cursor.
- To cancel and return to the previous screen, press MENU.
- Close the LoiLoScope AX program, if it starts.
- The subsequent operations are to be performed on the computer.

5 Click on the “JVCCAM_MEM” or “JVCCAM_SD” icon on the desktop.

- The folder opens.

6 Click on the column display icon.

Copying

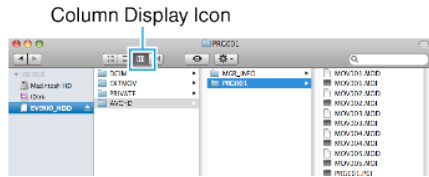

- Open the folder with the desired files.

“List of Files and Folders” (p. 51)

- 7 Copy the files to any folder in the computer (desktop, etc).

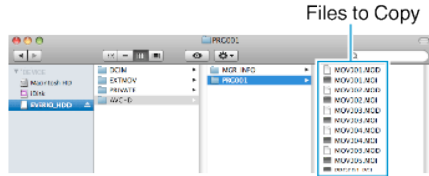

Caution :

- When the folders or files are deleted/moved/renamed in the computer, they cannot be played back on this unit anymore.
- MP4 files that are copied to a Mac computer cannot be imported to iMovie. To use MP4 files with iMovie, import the files using iMovie.

Memo :

- To edit/view the files, use a software that supports MP4 SD (video) files.
- When removing this unit from the computer, drag and drop the “JVCCAM_MEM” or “JVCCAM_SD” icon on the desktop to the trash bin.

iMovie

You can import files from this unit to a computer using Apple's iMovie '08, '09 or '11.

To verify the system requirements, select “About This Mac” from the Apple menu. You can determine the operating system version, processor and amount of memory.

- For the latest information on iMovie, refer to the Apple website.
- For details on how to use iMovie, refer to the help file of the software.
- There is no guarantee that the operations will work with all computer environments.

Operating the Menu

Use the operation buttons to set the menu.

- The menu differs according to the mode in use.

Memo :

To select/move cursor towards up/left or down/right, press the button UP/< or DOWN/>.

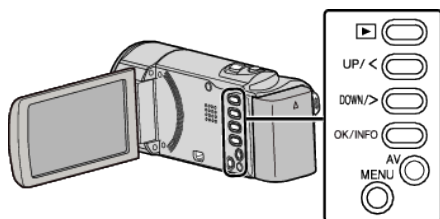

- 1 Press MENU.

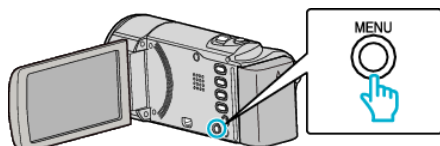

- 2 Select the desired menu and press OK.

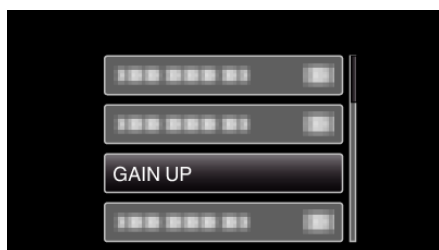

- 3 Select the desired setting and press OK.

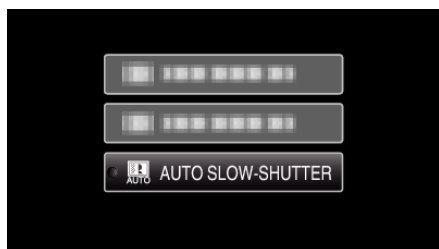

Memo :

- To return to the previous screen, press MENU.

Returning All Settings to Default:

- Set using "FACTORY PRESET" in the basic settings menu.

"FACTORY PRESET" (p. 66)

Recording Menu (Video)

You can adjust various settings, such as brightness and white balance, to suit the subject or purpose. You can also change settings such as picture quality and gain.

Setting	Details
MANUAL SETTING	Recording settings can be adjusted manually. <ul style="list-style-type: none"> They are displayed only when recording in the manual mode. “Manual Recording” (☞ p. 24)
FACE PRIORITY AE/AF	Detects faces and adjusts the brightness and focus automatically. “Capturing Human Subjects Clearly (Face Detection AE/AF)” (☞ p. 31)
DIS	Camera shake during recording can be effectively reduced. “Reducing Camera Shake” (☞ p. 31)
GAIN UP	Makes the subject appear bright automatically when recording in dark places. “GAIN UP” (☞ p. 56)
WIND CUT	Reduces the noise caused by wind. “WIND CUT” (☞ p. 56)
TIME-LAPSE RECORDING	Enables the changes of a scene that occur slowly over a long period to be shown within a short time by taking frames of it at a certain interval. “Recording at Intervals (TIME-LAPSE RECORDING)” (☞ p. 32)
AUTO REC	This function enables the unit to record automatically by sensing the changes in subject’s movement (brightness) within the red frame displayed on the LCD monitor. “Recording Automatically by Sensing Movements (AUTO REC)” (☞ p. 34)
VIDEO QUALITY	Sets the video quality. “VIDEO QUALITY” (☞ p. 57)
ZOOM	Sets the maximum zoom ratio. “ZOOM” (☞ p. 57)
CLOCK ADJUST	Resets the current time or sets to the local time when using this unit overseas. “CLOCK ADJUST” (☞ p. 57)

FACE PRIORITY AE/AF

Detects faces and adjusts the brightness and focus automatically.

Operating Details

“Capturing Human Subjects Clearly (Face Detection AE/AF)” (☞ p. 31)

DIS

Camera shake during recording can be effectively reduced.

Operating Details

“Reducing Camera Shake” (☞ p. 31)

Menu Settings

GAIN UP

Makes the subject appear bright automatically when recording in dark places.

Setting	Details
OFF	Deactivates the function.
ON	Electrically brightens the scene when it is dark.
AUTO SLOW-SHUTTER	Automatically brightens the scene when it is dark.

Memo :

- Although "AUTO SLOW-SHUTTER" brightens the scene more than "ON", movements of the subject may become unnatural.

Displaying the Item

Memo :

To select/move cursor towards up/left or down/right, press the button UP/< or DOWN/>.

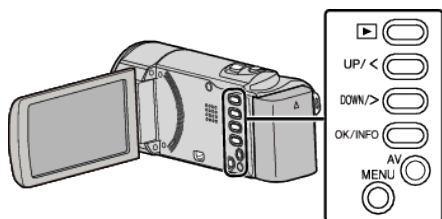

- 1 Press MENU.

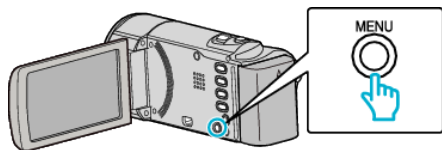

- 2 Select "GAIN UP" and press OK.

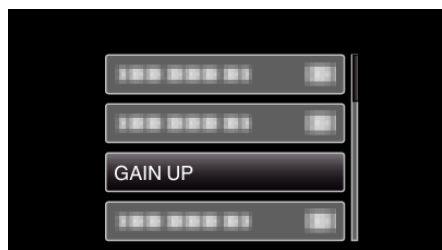

WIND CUT

Reduces the noise caused by wind.

Setting	Details
OFF	Deactivates the function.
ON	Activates the function.

Displaying the Item

Memo :

To select/move cursor towards up/left or down/right, press the button UP/< or DOWN/>.

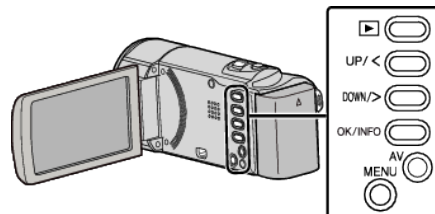

- 1 Press MENU.

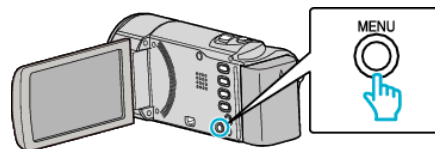

- 2 Select "WIND CUT" and press OK.



TIME-LAPSE RECORDING

Enables the changes of a scene that occur slowly over a long period to be shown within a short time by taking frames of it at a certain interval.

This is useful for making observations such as the opening of a flower bud.

Operating Details

"Recording at Intervals (TIME-LAPSE RECORDING)" (p. 32)

AUTO REC

Starts/stops recording automatically by sensing the changes in subject's movement (brightness) within the red frame displayed on the LCD monitor.

Operating Details

"Recording Automatically by Sensing Movements (AUTO REC)" (p. 34)

VIDEO QUALITY

Sets the video quality.

Setting	Details	
HRW	720 x 576 pixels 50i	Records in standard definition (16:9).
SRW	720 x 576 pixels 50i	For long recordings in standard definition (16:9).
HR	720 x 576 pixels 50i	Records in standard quality (4:3).
SR	720 x 576 pixels 50i	For long recordings in standard quality (4:3).

Memo : _____

- You can change the video quality from the remaining recording time display. Select the video quality with the UP/< and DOWN/> buttons and press OK.

Displaying the Item

Memo : _____

To select/move cursor towards up/left or down/right, press the button UP/< or DOWN/>.

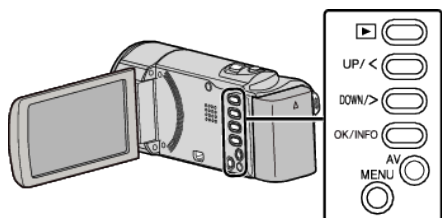

1 Press MENU.

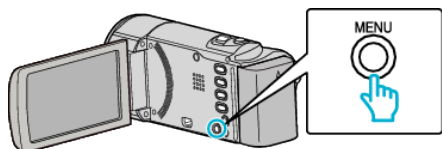

2 Select "VIDEO QUALITY" and press OK.

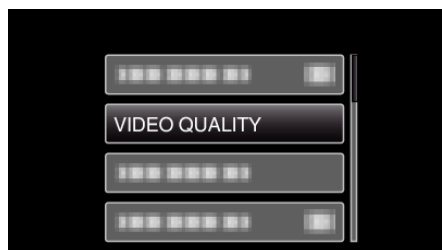

ZOOM

Sets the maximum zoom ratio.

Setting	Details	
40x/OPTICAL	Enables zooming up to 40x.	
70x/DYNAMIC	Enables zooming up to 70x.	
60x/DYNAMIC	Enables zooming up to 60x.	
200x/DIGITAL	Enables zooming up to 200x.	

Memo : _____

- "70x/DYNAMIC" is available only when "VIDEO QUALITY" is set to "HRW" or "SRW".
- "60x/DYNAMIC" is available only when "VIDEO QUALITY" is set to "HR" or "SR".
- You can expand the zoom area without degrading the image quality by using dynamic zoom.
- When digital zoom is used, the image becomes grainy as it is digitally enlarged.

Displaying the Item

Memo : _____

To select/move cursor towards up/left or down/right, press the button UP/< or DOWN/>.

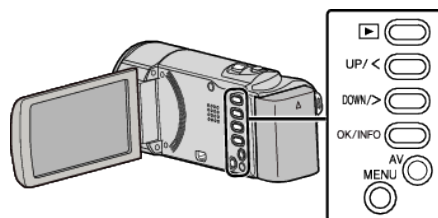

1 Press MENU.

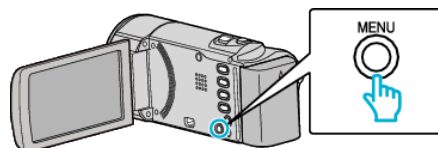

2 Select "ZOOM" and press OK.

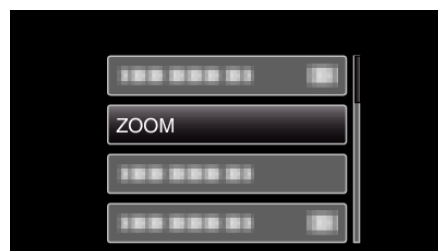

CLOCK ADJUST

Resets the current time or sets to the local time when using this unit overseas.

Setting	Details	
CLOCK SETTING	Resets the current time or changes the settings. "Resetting the Clock" (p. 17)	
AREA SETTING	Sets to the local time when using this unit overseas simply by selecting the destination. "Setting the Clock to Local Time when Traveling" (p. 20)	
DST SETTING	Sets whether daylight saving time is observed at the travel destination. "Setting Daylight Saving Time" (p. 20)	

Memo : _____

Menu Settings

- Daylight saving time is the system of setting the clock 1 hour ahead for a fixed period in summer.
It is used mainly in the Western countries.
-

Displaying the Item

Memo :

To select/move cursor towards up/left or down/right, press the button UP/< or DOWN/>.

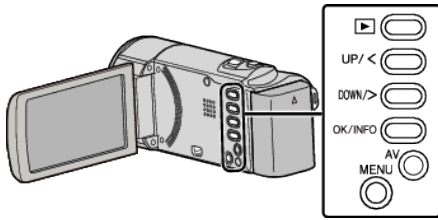

- 1 Press MENU.

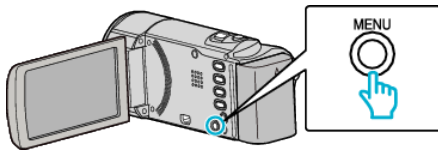

- 2 Select "CLOCK ADJUST" and press OK.

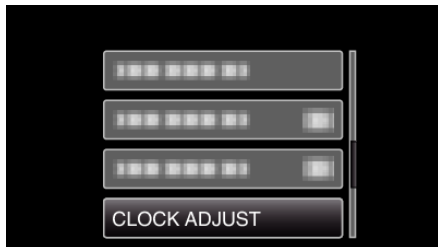

Manual Settings Menu

Recording settings can be adjusted manually.

Memo :

- They are displayed only when recording in the manual mode.

Setting	Details
SCENE SELECT	Settings to suit the shooting condition can be selected. "Scene Selection" (☞ p. 25)
FOCUS	Focus can be adjusted manually. "Adjusting Focus Manually" (☞ p. 26)
BRIGHTNESS ADJUST	Adjusts the overall brightness of the screen. "Adjusting Brightness" (☞ p. 27)
WHITE BALANCE	Adjusts the color according to the light source. "Setting White Balance" (☞ p. 28)
BACKLIGHT COMP.	Corrects the image when the subject appears dark due to backlight. "Setting Backlight Compensation" (☞ p. 29)
TELE MACRO	Enables close-up shots when using the telephoto (T) end of the zoom. "Taking Close-up Shots" (☞ p. 30)

SCENE SELECT

Settings to suit the shooting condition can be selected.

Operating Details

"Scene Selection" (☞ p. 25)

FOCUS

Focus can be adjusted manually.

Operating Details

"Adjusting Focus Manually" (☞ p. 26)

BRIGHTNESS ADJUST

Adjusts the overall brightness of the screen.

Operating Details

"Adjusting Brightness" (☞ p. 27)

WHITE BALANCE

Adjusts the color according to the light source.

Operating Details

"Setting White Balance" (☞ p. 28)

BACKLIGHT COMP.

Corrects the image when the subject appears dark due to backlight.

Operating Details

"Setting Backlight Compensation" (☞ p. 29)

TELE MACRO

Enables close-up shots when using the telephoto (T) end of the zoom.

Operating Details

"Taking Close-up Shots" (☞ p. 30)

Playback Menu (Video)

You can delete or look for specific videos.

Setting	Details
DELETE	Deletes unwanted videos. “Deleting the Currently Displayed File” (p. 40) “Deleting Selected Files” (p. 41) “Deleting All Files” (p. 42)
PROTECT/CANCEL	Protects files from being deleted accidentally. “Protecting the Currently Displayed File” (p. 42) “Protecting Selected Files” (p. 43) “Protecting All Files” (p. 44) “Releasing Protection of All Files” (p. 44)
CLOCK ADJUST	Resets the current time or sets to the local time when using this unit overseas. “CLOCK ADJUST” (p. 61)
ON-SCREEN DISPLAY	Sets whether to show on-screen displays such as icons during playback. “ON-SCREEN DISPLAY” (p. 61)

DELETE

Deletes unwanted videos.

Operating Details

“Deleting the Currently Displayed File” (p. 40)

“Deleting Selected Files” (p. 41)

“Deleting All Files” (p. 42)

PROTECT/CANCEL

Protects files from being deleted accidentally.

Operating Details

“Protecting the Currently Displayed File” (p. 42)

“Protecting Selected Files” (p. 43)

“Protecting All Files” (p. 44)

“Releasing Protection of All Files” (p. 44)

CLOCK ADJUST

Resets the current time or sets to the local time when using this unit overseas.

Setting	Details
CLOCK SETTING	Resets the current time or changes the settings. “Resetting the Clock” (p. 17)
AREA SETTING	Sets to the local time when using this unit overseas simply by selecting the destination. “Setting the Clock to Local Time when Traveling” (p. 20)
DST SETTING	Sets whether daylight saving time is observed at the travel destination. “Setting Daylight Saving Time” (p. 20)

Memo :

- Daylight saving time is the system of setting the clock 1 hour ahead for a fixed period in summer. It is used mainly in the Western countries.

Displaying the Item

Memo :

To select/move cursor towards up/left or down/right, press the button UP/< or DOWN/>.

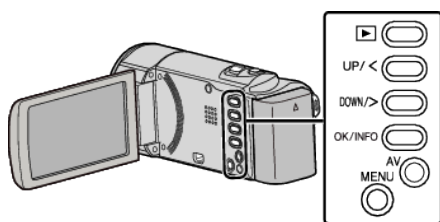

1 Press MENU.

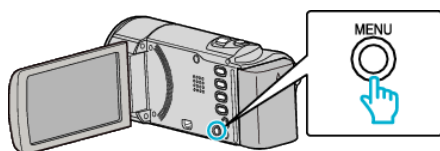

2 Select “CLOCK ADJUST” and press OK.

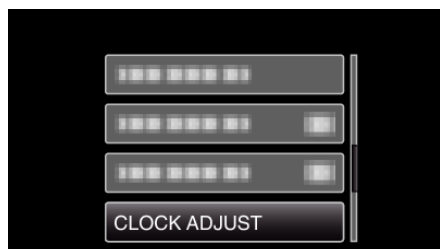

Setting	Details
OFF	No display at all.
ON	Displays everything.

Displaying the Item

Memo :

To select/move cursor towards up/left or down/right, press the button UP/< or DOWN/>.

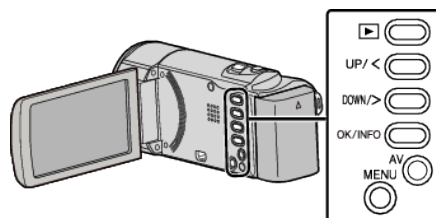

1 Press MENU.

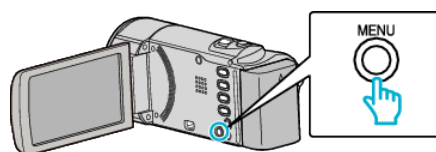

2 Select “ON-SCREEN DISPLAY” and press OK.

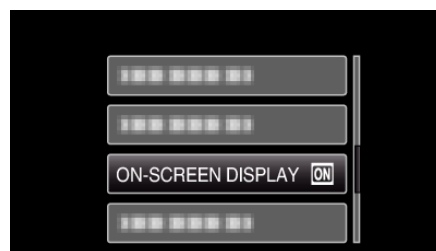

ON-SCREEN DISPLAY

Sets whether to show on-screen displays such as icons during playback.

Display Settings Menu

You can adjust various display settings such as the LCD monitor's brightness, etc.

Setting	Details
LANGUAGE	The language on the display can be changed. "Changing the Display Language" (☞ p. 18)
DATE DISPLAY STYLE	Sets the order of year, month, day and the time display format (24H/12H). "DATE DISPLAY STYLE" (☞ p. 62)
MONITOR BRIGHTNESS	Sets the brightness of the LCD monitor. "MONITOR BRIGHTNESS" (☞ p. 63)

LANGUAGE

The language on the display can be changed.

Operating Details

"Changing the Display Language" (☞ p. 18)

- For date display, set to any format from "month.day.year", "year.month.day", and "day.month.year".
- For time display, set to any format from "12h" and "24h".
- Press UP/< or DOWN/> to move the cursor.
- After setting, press OK.

DATE DISPLAY STYLE

Sets the order of year, month, day and the time display format (24H/12H).

Memo :

To select/move cursor towards up/left or down/right, press the button UP/< or DOWN/>.

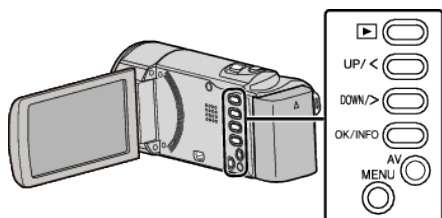

1 Press MENU.

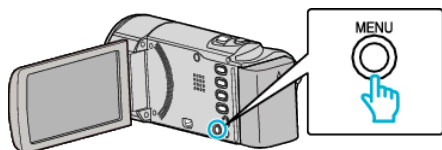

2 Select "DISPLAY SETTINGS" and press OK.

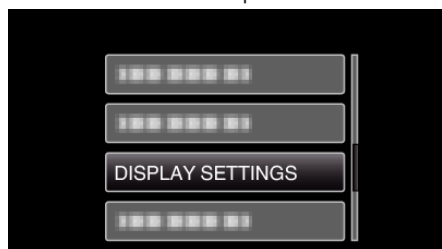

3 Select "DATE DISPLAY STYLE" and press OK.

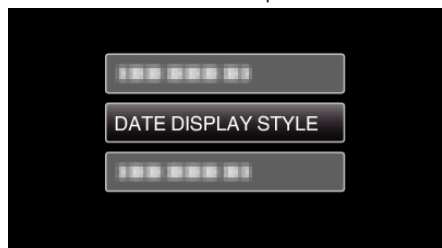

4 Set the style of date and time display.

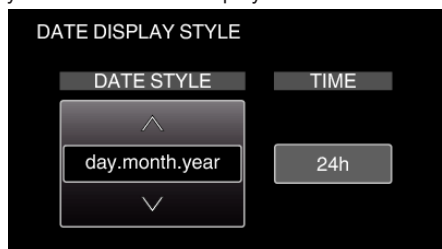

Clock Set Style

The clock set style of this unit varies with the models.

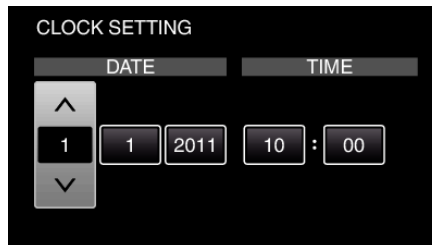
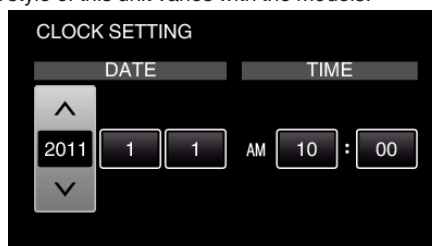

- The order of "Year, Month, Day, Time" changes according to the date display style.

MONITOR BRIGHTNESS

Sets the brightness of the LCD monitor.

Setting	Details
4	Brightens the backlight of the monitor regardless of the surrounding conditions.
3	Sets to the standard brightness.
2	Darkens the backlight of the monitor regardless of the surrounding conditions.
1	Sets to dim brightness. Helps to save battery life when selected.
AUTO	Sets the brightness automatically to "4" when using outdoors and to "3" when using indoors.

Displaying the Item

Memo : _____

To select/move cursor towards up/left or down/right, press the button UP/< or DOWN/>.

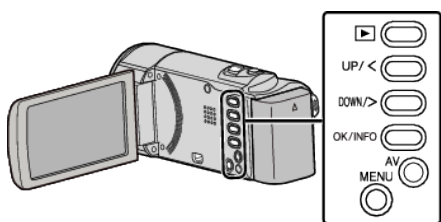

1 Press MENU.

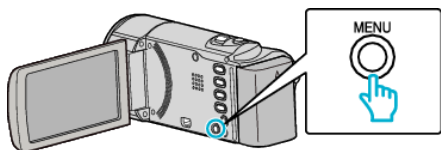

2 Select "DISPLAY SETTINGS" and press OK.

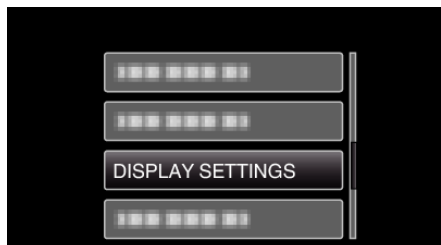

3 Select "MONITOR BRIGHTNESS" and press OK.

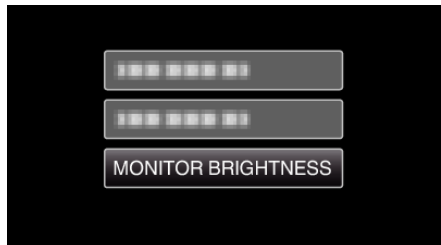

Basic Settings Menu

You can adjust various camera settings such as operation sound, etc.

Setting	Details
DEMO MODE	Introduces the special features of this unit in digest form. “DEMO MODE” (☞ p. 64)
AUTO POWER OFF	Prevents the situation of forgetting to turn off the power when this is set. “AUTO POWER OFF” (☞ p. 65)
OPERATION SOUND	Turns on or off the operation sound. “OPERATION SOUND” (☞ p. 65)
QUICK RESTART	Reduces the power consumption within 5 minutes after the LCD monitor is closed to 1/3 of that used during recording. “QUICK RESTART” (☞ p. 66)
UPDATE	Updates the functions of this unit to the latest version. “UPDATE” (☞ p. 66)
FACTORY PRESET	Returns all the settings to their default values. “FACTORY PRESET” (☞ p. 66)

DEMO MODE

Plays a demonstration of the special features of this unit.

Setting	Details
OFF	Deactivates the function.
ON	Plays a demonstration of the special features of this unit.

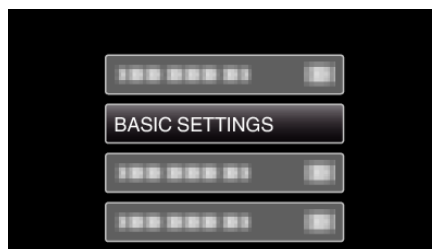

3 Select “DEMO MODE” and press OK.

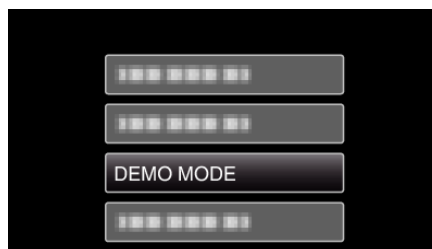

Displaying Demo Mode

- 1 Remove the battery pack and SD card.
- 2 Connect the AC adapter.
- 3 Open the LCD monitor and the unit powers on automatically.

- Demonstration starts playing after 3 minutes.
- To stop playback, press OK.

Memo :

- This mode is not available in the playback mode.

Displaying the Item

Memo :

To select/move cursor towards up/left or down/right, press the button UP/< or DOWN/>.

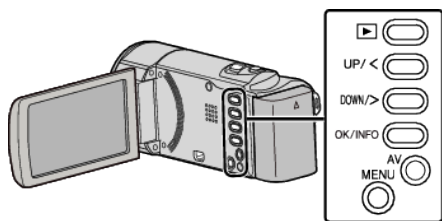

1 Press MENU.

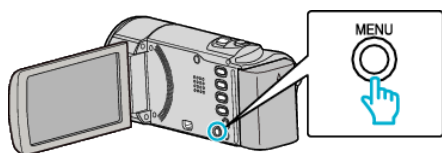

2 Select “BASIC SETTINGS” and press OK.

OPERATION SOUND

Turns on or off the operation sound.

Setting	Details
OFF	Turns off the operation sound.
ON	Turns on the operation sound.

Displaying the Item

Memo : _____

To select/move cursor towards up/left or down/right, press the button UP/< or DOWN/>.

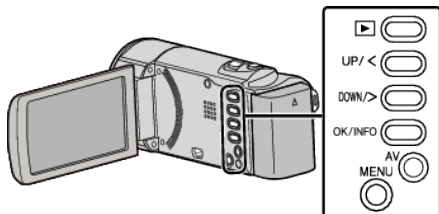

1 Press MENU.

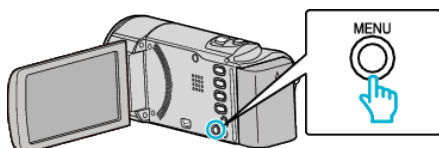

2 Select "BASIC SETTINGS" and press OK.

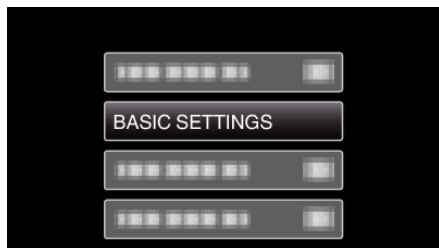

3 Select "OPERATION SOUND" and press OK.

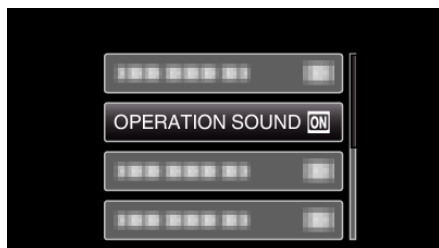

AUTO POWER OFF

Prevents the situation of forgetting to turn off the power when this is set.

Setting	Details
OFF	Power is not turned off even if this unit is not operated for 5 minutes.
ON	Turns off the power automatically if this unit is not operated for 5 minutes.

Memo : _____

- When using battery, power is turned off automatically if this unit is not operated for 5 minutes.
- When using the AC adapter, this unit goes into standby mode.

Displaying the Item

Memo : _____

To select/move cursor towards up/left or down/right, press the button UP/< or DOWN/>.

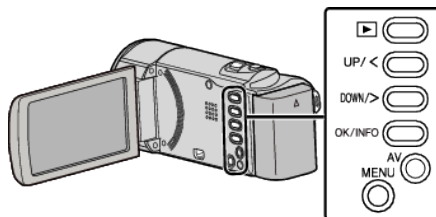

1 Press MENU.

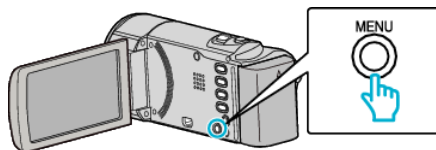

2 Select "BASIC SETTINGS" and press OK.

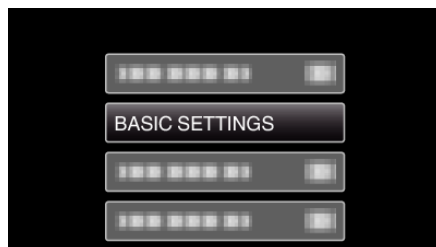

3 Select "AUTO POWER OFF" and press OK.



QUICK RESTART

Enables the power to turn on quickly when the LCD monitor is opened again within 5 minutes.

Setting	Details
OFF	Deactivates the function.
ON	Enables the power to turn on quickly when the LCD monitor is opened again within 5 minutes.

Memo : _____

- The power consumption within 5 minutes after the LCD monitor is closed is reduced.

Displaying the Item

Memo : _____

To select/move cursor towards up/left or down/right, press the button UP/< or DOWN/>.

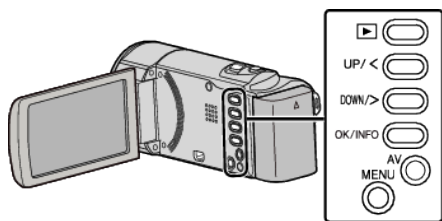

- 1 Press MENU.

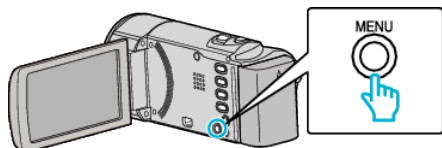

- 2 Select "BASIC SETTINGS" and press OK.

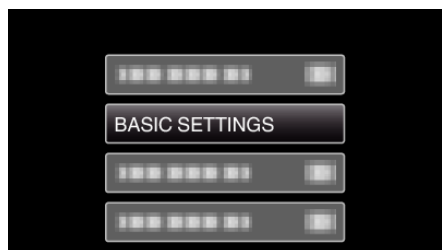

- 3 Select "QUICK RESTART" and press OK.

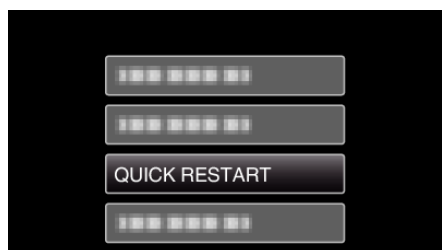

- The power consumption within 5 minutes after the LCD monitor is closed is reduced.

UPDATE

Updates the functions of this unit to the latest version.

For details, refer to the JVC homepage.

(When no program to update the software of this unit is available, nothing will be provided on the homepage.)

<http://www.jvc-victor.co.jp/dvmain/support/download/index.html>

FACTORY PRESET

Returns all the settings to their default values.

Memo : _____

To select/move cursor towards up/left or down/right, press the button UP/< or DOWN/>.

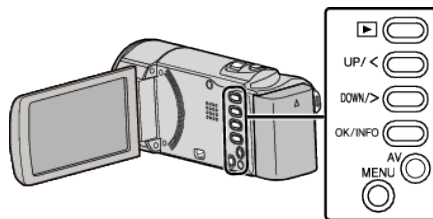

- 1 Press MENU.

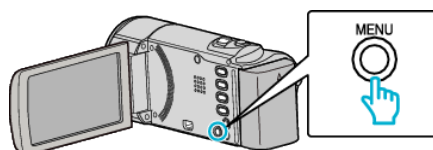

- 2 Select "BASIC SETTINGS" and press OK.

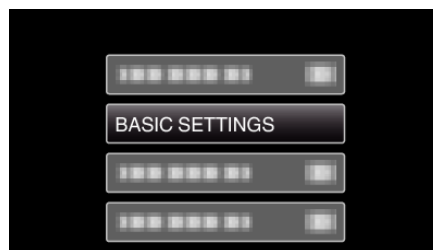

- 3 Select "FACTORY PRESET" and press OK.



- 4 Select "YES" and press OK.

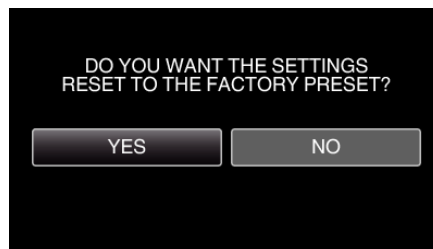

- All settings return to their default values.

Connection Settings Menu

You can adjust various settings for connecting to a TV or DVD recorder.

Setting	Details
DISPLAY ON TV	Displays icons and date/time on a TV screen. "DISPLAY ON TV" (p. 67)
VIDEO OUTPUT	Sets the aspect ratio (16:9 or 4:3) according to the connecting TV. "VIDEO OUTPUT" (p. 67)

DISPLAY ON TV

Displays icons and date/time on a TV screen.

Setting	Details
OFF	Does not display icons and date/time on TV.
ON	Displays icons and date/time on TV.

Displaying the Item

Memo : _____

To select/move cursor towards up/left or down/right, press the button UP/< or DOWN/>.

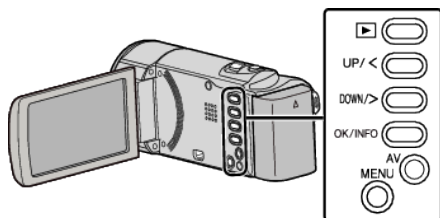

- 1 Press MENU.

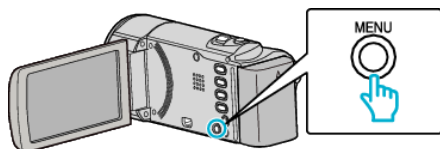

- 2 Select "CONNECTION SETTINGS" and press OK.



- 3 Select "DISPLAY ON TV" and press OK.



VIDEO OUTPUT

Sets the aspect ratio (16:9 or 4:3) according to the connecting TV.

Setting	Details
4:3	Select this when connecting to a conventional TV (4:3).
16:9	Select this when connecting to a widescreen TV (16:9).

Displaying the Item

Memo : _____

To select/move cursor towards up/left or down/right, press the button UP/< or DOWN/>.

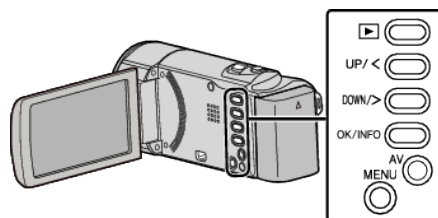

- 1 Press MENU.

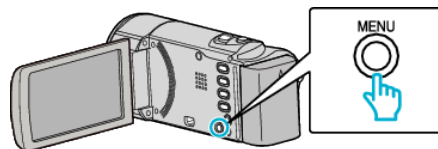

- 2 Select "CONNECTION SETTINGS" and press OK.

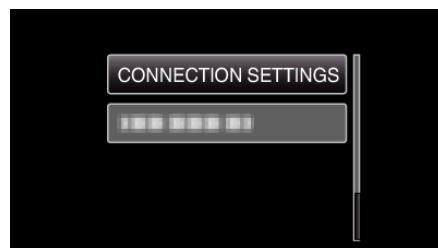

- 3 Select "VIDEO OUTPUT" and press OK.

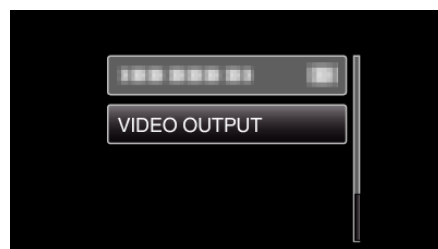

Media Settings Menu

You can perform various settings for the recording media.

Setting	Details
FORMAT SD CARD	Deletes all files on the SD card. “FORMAT SD CARD” (p. 68)

FORMAT SD CARD

Deletes all files on the SD card.

Setting	Details
FILE	Deletes all files on the SD card.
FILE + MANAGEMENT NO	Deletes all files on the SD card and resets the folder and file numbers to "1".

Caution :

- Not available for selection when no SD card is inserted.
- All data on the card will be deleted when it is formatted. Copy all files on the card to a computer before formatting.
- Make sure that the battery pack is fully charged or connect the AC adapter as the formatting process may take some time.

Displaying the Item

Memo :

To select/move cursor towards up/left or down/right, press the button UP/< or DOWN/>.

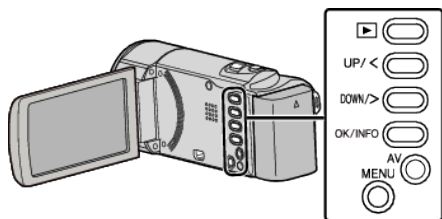

1 Press MENU.

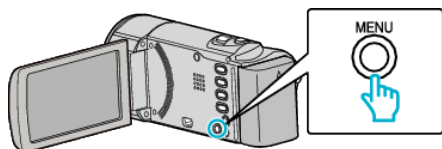

2 Select “MEDIA SETTINGS” and press OK.

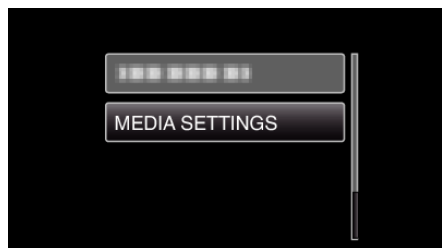

3 Select “FORMAT SD CARD” and press OK.

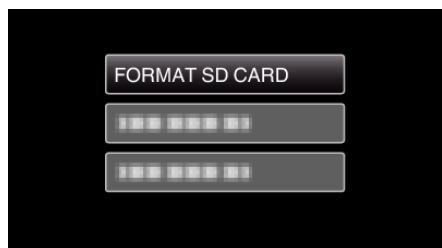

4 Select the desired setting and press OK.



5 Select “YES” and press OK.



Front

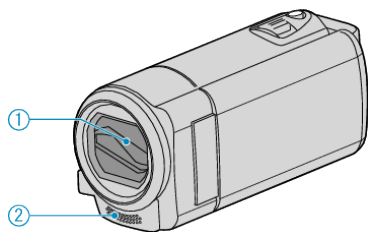

- 1** Lens Cover
 - Do not touch the lens and lens cover.
 - Do not cover the lens with your fingers during recording.
- 2** Monaural Microphone
 - Do not cover the microphone with your fingers during video recording.

Rear

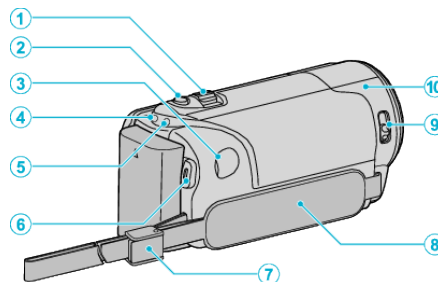

- 1** Zoom/Volume Lever
 - During shooting: Adjusts the shooting range.
 - During video playback: Adjusts the volume.
 - During index screen display: Moves to the next or previous page.
- 2** i.AUTO Button
 - Switches between Intelligent Auto and Manual modes.
- 3** DC Connector
 - Connects to an AC adapter to charge the battery.
- 4** ACCESS (Access) Lamp
 - Lights up/blinks during recording or playback.
 - Do not remove the battery pack, AC adapter, or SD card.
- 5** POWER/CHARGE (Power/Charge) Lamp
 - Lights up: Power "ON"
 - Blinks: Charging in progress
 - Goes out: Charging finished
- 6** START/STOP Button (Video Recording) /
▶/|| (Play/Pause) Button (Video Playback)
 - Starts/stops video recording.
 - Starts/pauses video playback.
- 7** Strap Lock
 - Allows the grip belt to be removed and used as a hand strap.
- 8** Grip Belt
 - Pass your hand through the grip belt to hold this unit firmly.
 - "Grip Adjustment" (p. 14)
- 9** Lens Cover Switch
 - Opens and closes the lens cover.
- 10** Camera Sensor
 - Do not cover the internal sensor with your fingers during video recording.

Bottom

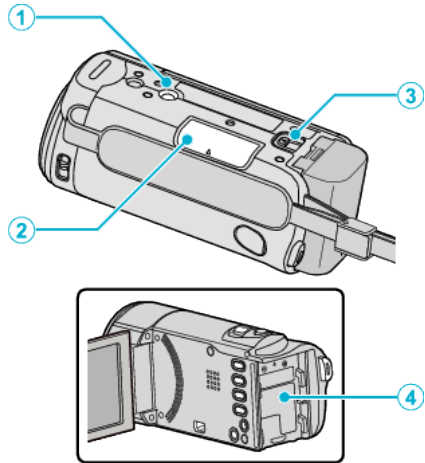

- 1** Tripod Mounting Hole
"Tripod Mounting" (☞ p. 19)
- 2** SD Card Slot
 - Insert an optional SD card.
"Inserting an SD Card" (☞ p. 14)
- 3** Battery Release Lever
"Charging the Battery Pack" (☞ p. 13)
- 4** Battery Mount

Interior

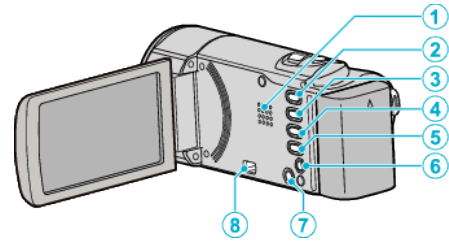

- 1** Speaker
 - Outputs audio sound during video playback.
- 2** (Play/Record) Button
 - Switches between recording and playback modes.
- 3** UP/< Button
 - UP: Scrolls/moves cursor on the icons upward
 - <: Reverse search
- 4** DOWN/> Button
 - DOWN: Scrolls/moves cursor on the icons downward
 - >: Forward search
- 5** OK/INFO Button
 - Confirms the selection. / Displays information as follows.
 - Recording: Displays the remaining time and battery power.
 - Playback: Displays file information such as recording date.
- 6** AV Connector
 - Connects to a TV, etc.
- 7** MENU (Menu) Button
- 8** USB Connector
 - Connects to computer using a USB cable.

LCD Monitor

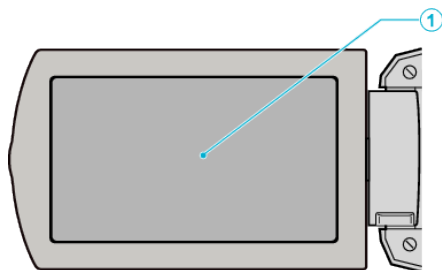

1 LCD Monitor

- Turns the power on/off by opening and closing.
- Enables self-portraits to be taken by rotating the monitor.

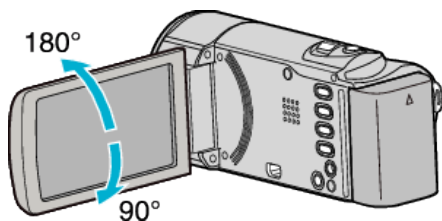
**Caution :**

- Do not press against the surface with force or subject it to strong impact. Doing so may damage or break the screen.

Video Recording

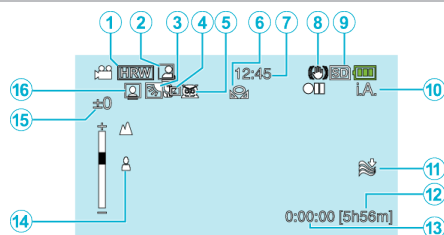

- 1** Video Quality
“VIDEO QUALITY” (☞ p. 57)
- 2** Auto REC
“Recording Automatically by Sensing Movements (AUTO REC)”
(☞ p. 34)
- 3** Backlight Compensation
“Setting Backlight Compensation” (☞ p. 29)
- 4** Tele Macro
“Taking Close-up Shots” (☞ p. 30)
- 5** Scene Select
“Scene Selection” (☞ p. 25)
- 6** White Balance
“Setting White Balance” (☞ p. 28)
- 7** Date/Time
“Clock Setting” (☞ p. 16)
- 8** Digital Image Stabilizer
“Reducing Camera Shake” (☞ p. 31)
- 9** Media
- 10** Recording Mode
“Taking Videos in Intelligent Auto Mode” (☞ p. 22)
“Manual Recording” (☞ p. 24)
- 11** Wind Cut
“WIND CUT” (☞ p. 56)
- 12** Remaining Recording Time
- 13** Scene Counter
- 14** Focus
“Adjusting Focus Manually” (☞ p. 26)
- 15** Brightness
“Adjusting Brightness” (☞ p. 27)
- 16** Face Priority AE/AF
“Capturing Human Subjects Clearly (Face Detection AE/AF)”
(☞ p. 31)

Video Playback

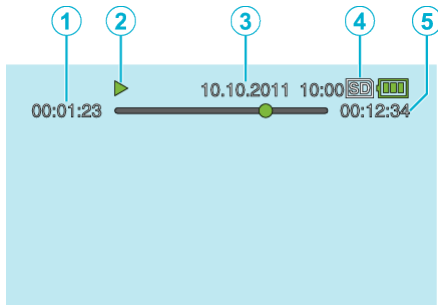

- 1** Scene Counter
- 2** Operation Indicator
"Playing Back Videos" (see p. 37)
- 3** Date/Time
"Clock Setting" (see p. 16)
- 4** Media
- 5** Playback Time
"Playing Back Videos" (see p. 37)

Battery Pack

Unable to turn on the power when using the battery pack.

Recharge the battery pack.

“Charging the Battery Pack” (☞ p. 12)

If the terminal of this unit or the battery pack is dirty, wipe it with a cotton swab or something similar.

If you use any other battery packs besides JVC battery packs, safety and performance cannot be guaranteed. Be sure to use JVC battery packs.

When the battery level is extremely low, this unit does not turn on until it is charged even if it is connected to a computer or AC adapter.

Short usage time even after charging.

Battery deterioration occurs when a battery pack is charged repeatedly.

Replace the battery pack with a new one.

“Optional Accessories” (☞ p. 21)

Unable to charge the battery pack.

When the battery pack is fully charged, the lamp does not flash.

If the terminal of this unit or the battery pack is dirty, wipe it with a cotton swab or something similar.

Using a non-original AC adapter may result in damage to this unit. Be sure to use an original AC adapter.

When charging via a computer, turn on the computer.

The remaining battery display is not correct.

Remaining battery power is not displayed when the AC adapter is connected.

If this unit is used for long periods of time in high or low temperatures, or if the battery pack is repeatedly charged, the amount of remaining battery may not be displayed correctly.

The battery depletes even when the AC adapter is connected.

Please use a JVC AC adapter (AC-V10).

Recording

Recording cannot be performed.

Set to the recording mode with the  (Play/Record) button.

“Interior” (☞ p. 70)

Recording stops automatically.

Recording stops automatically as it cannot be performed for 12 or more consecutive hours according to specifications. (It may take some time to resume recording.)

Turn off this unit, wait for a while, and turn it on again. (This unit stops automatically to protect the circuit when the temperature rises.)

The focus is not adjusted automatically.

If you are recording in a dark place or a subject that has no contrast between dark and light, adjust the focus manually.

“Adjusting Focus Manually” (☞ p. 26)

Wipe the lens with a lens cleaning cloth.

Cancel manual focus on the manual recording menu.

“Adjusting Focus Manually” (☞ p. 26)

Zoom does not work.

Zoom operation is not available in time-lapse recording.

To use digital zoom, set “ZOOM” in the menu to “200x/DIGITAL”.

“ZOOM” (☞ p. 57)

Vertical lines appear on recorded images.

Such a phenomenon occurs when shooting a subject illuminated by bright light. This is not a malfunction.

Card

Cannot insert the SD card.

Make sure not to insert the card in the wrong direction.

“Inserting an SD Card” (☞ p. 14)

Playback

Sound or video is interrupted.

Sometimes playback is interrupted at the connecting section between two scenes. This is not a malfunction.

The same image is displayed for a long time.

Replace the SD card. (When the SD card is damaged, difficulty in reading the data occurs. This unit will try to play back as much as possible, but it will stop eventually if the condition persists.)

The motion is choppy.

Replace the SD card. (When the SD card is damaged, difficulty in reading the data occurs. This unit will try to play back as much as possible, but it will stop eventually if the condition persists.)

Execute “FORMAT SD CARD” in the “MEDIA SETTINGS” menu. (All data will be deleted.)

“FORMAT SD CARD” (☞ p. 68)

Verify the system requirements of your PC when using LoiLoScope AX to play back.

“Verifying System Requirements (Guideline)” (☞ p. 47)

No date/time display.

Set “ON-SCREEN DISPLAY” in the menu accordingly.

“ON-SCREEN DISPLAY” (☞ p. 61)

Set “DISPLAY ON TV” in the menu to “ON”.

“DISPLAY ON TV” (☞ p. 67)

Images are projected vertically on the TV.

Set “VIDEO OUTPUT” in the “CONNECTION SETTINGS” menu to “4:3”.

“VIDEO OUTPUT” (☞ p. 67)

Adjust the TV's screen accordingly.

The image displayed on TV is too small.

Set “VIDEO OUTPUT” in the “CONNECTION SETTINGS” menu to “16:9”.

“VIDEO OUTPUT” (☞ p. 67)

Editing/Copying

Unable to dub to a Blu-ray recorder.

Dubbing cannot be performed by connecting this unit to a Blu-ray recorder with a USB cable. Connect and dub using the supplied AV cable.
 “Dubbing Files by Connecting to a DVD Recorder or VCR” (p. 45)

Unable to delete file.

Files that are protected cannot be deleted. Release protection before deleting the file.
 “Protecting Files” (p. 42)

Computer

Unable to copy files to the computer’s HDD.

Connect the USB cable correctly.
 “Backing Up All Files” (p. 48)
 If the provided software LoiLoScope AX is not installed, some functions may not work properly.
 “Installing the Provided Software” (p. 47)
 Before making backup, make sure that enough free space is left in the computer’s hard disk (HDD).

Unable to copy files to DVD with a computer.

To record to discs, a recordable DVD drive is required for the computer in use.

I am using a Mac computer.

Copy the files to a Mac computer using the following method.
 “Copying to Mac Computer” (p. 51)

The computer cannot recognize the SDXC card.

Confirm and update the OS of your computer.

Screen/Image

The LCD monitor is difficult to see.

The LCD monitor may be difficult to see if used in bright areas such as under direct sunlight.

A band or a ball of bright light appears on the LCD monitor.

Change the direction of this unit to prevent the light source from coming into view. (A band or a ball of bright light may appear when there is a bright light source near this unit, but this is not a malfunction.)

The recorded subject is too dark.

Use backlight compensation when the background is bright and the subject is dark.

“Setting Backlight Compensation” (☞ p. 29)

Use “NIGHTALIVE” in “SCENE SELECT”.

“Scene Selection” (☞ p. 25)

Use “GAIN UP” in the menu.

“GAIN UP” (☞ p. 56)

Set “BRIGHTNESS ADJUST” in the manual settings menu to the “+” side.

“Adjusting Brightness” (☞ p. 27)

The recorded subject is too bright.

Set “BACKLIGHT COMP.” to “OFF” if it is being used.

“Setting Backlight Compensation” (☞ p. 29)

Set “BRIGHTNESS ADJUST” in the manual settings menu to the “-” side.

“Adjusting Brightness” (☞ p. 27)

The color looks strange. (Too bluish, too reddish, etc.)

Wait for a while until natural colors are achieved. (It may take some time for white balance to be adjusted.)

Set “WHITE BALANCE” in the manual settings menu to “MANUAL”. Select

from “FINE”/“CLOUD”/“HALOGEN” according to the light source. Select

“MWB” and adjust accordingly.

“Setting White Balance” (☞ p. 28)

The color looks different.

Set “WHITE BALANCE” in the manual settings menu to “MANUAL”. Select

from “FINE”/“CLOUD”/“HALOGEN” according to the light source. Select

“MWB” and adjust accordingly.

“Setting White Balance” (☞ p. 28)

There are bright or dark spots on the screen.

While the LCD monitor screen has more than 99.99% effective pixels, 0.01% of the pixels may be bright spots (red, blue, green) or dark spots. This is not a malfunction. The spots will not be recorded.

Other Problems

The image is grainy.

When digital zoom is used, the image becomes grainy as it is digitally enlarged.

This unit heats up.

This is not a malfunction. (This unit may become warm when used for a long time.)

The unit operates slowly when switching between modes, or when switching the power on or off.

It is recommended that you copy all files onto your computer, and erase the files from this unit. (If there are many recorded files on this unit, it takes time for the unit to respond.)

Make a backup of important recorded data.

It is recommended to copy your important recorded data to a DVD or other recording media for storage.

JVC will not be responsible for any lost data.

Error Message?

CHECK LENS COVER

Open the lens cover.

SET DATE/TIME!

Connect the AC adapter, charge the battery for more than 24 hours and set the clock. (If the message still appears, the clock battery is exhausted. Consult your nearest JVC dealer.)

“Clock Setting” (☞ p. 16)

COMMUNICATION ERROR

Reconnect the USB cable.

Turn off this unit and the devices connected to it, and turn them on again.

Reattach the battery pack.

NOT FORMATTED

Select “OK”, then select “YES” on the “DO YOU WANT TO FORMAT?” screen.

RECORDING FAILURE

Turn off and on this unit again.

PLAYBACK FAILED

Remove and re-insert the SD card.

“Inserting an SD Card” (☞ p. 14)

Remove any dirt from the SD card terminals.

Insert the SD card before turning on the power.

Do not subject this unit to any strong impact or vibration.

UNSUPPORTED FILE!

Use files recorded with this unit. (Files recorded with other devices may not be playable.)

THIS FILE IS PROTECTED

Switch off the “PROTECT/CANCEL” function in the menu.

“Protecting Files” (☞ p. 42)

CHECK CARD'S WRITE PROTECTION SWITCH

Set the write protect switch of the SD card to off.

INSUFFICIENT AVAILABLE SPACE

Delete files, or move files to a computer or other devices.

Replace the SD card with a new one.

MAXIMUM QUANTITY RECORDING FOLDERS/FILES HAS BEEN REACHED

① Move the files or folders to a computer or other device. (Back up your files.)

② Select “FILE + MANAGEMENT NO” in “FORMAT SD CARD” of the “MEDIA SETTINGS” menu. (All data on the SD card will be deleted.)

SCENE QUANTITY EXCEEDED LIMIT

① Move the files or folders to a computer or other device. (Back up your files.)

② Select “FILE + MANAGEMENT NO” in “FORMAT SD CARD” of the “MEDIA SETTINGS” menu. (All data on the SD card will be deleted.)

NUMBER OF FOLDERS OVERFLOW

① Move the files or folders to a computer or other device. (Back up your files.)

② Select “FILE + MANAGEMENT NO” in “FORMAT SD CARD” of the “MEDIA SETTINGS” menu. (All data on the SD card will be deleted.)

FILE QUANTITY LIMIT EXCEEDED

① Move the files or folders to a computer or other device. (Back up your files.)

② Select “FILE + MANAGEMENT NO” in “FORMAT SD CARD” of the “MEDIA SETTINGS” menu. (All data on the SD card will be deleted.)

CAMERA TEMPERATURE IS TOO COLD KEEP CAMERA POWER ON PLEASE WAIT

Leave this unit turned on for a while.

If the warning still does not disappear, turn off the power and move the unit to a warm place while taking care to avoid a sudden temperature change.

Turn on the power again after a while.

Maintenance

Perform regular maintenance of this unit to enable it to be used for a long time.

Caution :

- Be sure to detach the battery pack, AC adapter, and power plug before performing any maintenance.

Camcorder

- Wipe this unit with a dry, soft cloth to remove any dirt.
- When it is extremely dirty, soak the cloth in a solution of neutral detergent, wipe the body with it, and then use a clean cloth to remove the detergent.

Caution :

- Do not use benzene or thinner. Doing so may cause damage to the unit.
- When using a chemical cloth or cleaner, be sure to observe the warning labels and instructions of the product.
- Do not leave the device in contact with rubber or plastic products for a long time.

Lens/LCD Monitor

- Use a lens blower (commercially available) to remove any dust, and a cleaning cloth (commercially available) to wipe off any dirt.
Mold may form if the lens is left dirty.

Camera

Item	Details
Power supply	Using AC adapter: DC 5.2 V Using battery pack: DC 3.5 V - 3.6 V
Power consumption	2.2 W (when "MONITOR BRIGHTNESS" is set to "3" (standard)) 2.4 W (when "MONITOR BRIGHTNESS" is set to "4" (brighter)) Rated Current Consumption: 1A
Dimensions (mm)	50.5 mm x 55 mm x 110.5 mm (W x H x D: excluding grip belt)
Mass	Approx. 180 g (camera only), Approx. 215 g (including supplied battery pack)
Operating environment	Allowable operating temperature: 0°C to 40°C Allowable storage temperature: -20°C to 50°C Allowable relative humidity: 35 % to 80 %
Image pickup device	1/5.8" 1,500,000 pixels (progressive CMOS)
Recording area (Video)	HRW/SRW: 340,000 to 1,050,000 pixels (dynamic zoom ON) 630,000 to 1,050,000 pixels (dynamic zoom OFF) HR/SR: 340,000 to 790,000 pixels (dynamic zoom ON) 470,000 to 790,000 pixels (dynamic zoom OFF)
Lens	F1.8 - 6.3, f= 2.9 mm to 116.0 mm 16:9 35 mm conversion: 45.6 mm to 3,182 mm (dynamic zoom ON) 35 mm conversion: 45.6 mm to 1,824 mm (dynamic zoom OFF) 4:3 35 mm conversion: 55.9 mm to 3,376 mm (dynamic zoom ON) 35 mm conversion: 55.9 mm to 2,236 mm (dynamic zoom OFF)
Zoom (during video recording)	Optical zoom: Up to 40x Dynamic zoom: Up to 70x (16:9), Up to 60x (4:3) Digital zoom: Up to 200x
LCD monitor	2.7" wide, 230K pixels, polysilicon color LCD
Recording media	SDHC/SDXC card (commercially available) Eye-Fi card (commercially available)
Clock battery	Rechargeable battery

Connectors

Item	Details
AV output connector	Video output: 1.0 V (p-p), 75 Ω Audio output: 300 mV (rms), 1 KΩ
USB connector	Mini USB Type B, USB 2.0 compliant

Video

Item	Details
Recording/ Playback format	MP4 standard Video: MP4 SD Audio: AAC (2ch mono)
Extension	.MP4
Signal system	PAL standard
Image quality (Video)	HRW (16:9) 720 x 576p Average Approximate 8.5 Mbps SRW (16:9) 720 x 576p Average Approximate 4.0 Mbps HR (4:3) 720 x 576p Average Approximate 8.5 Mbps SR (4:3) 720 x 576p Average Approximate 4.0 Mbps
Sound quality (Audio)	48 kHz, 128 kbps

AC Adapter (AC-V10M)

Item	Details
Power supply	AC 110 V to 240 V, 50 Hz/60 Hz
Output	DC 5.2 V, 1 A
Allowable operating temperature	0°C to 40°C (10°C to 35°C during charging)
Dimensions (mm)	83 mm x 28 mm x 40 mm (W x H x D: excluding cord and AC plug)
Mass	Approx. 77 g

Battery Pack (BN-VG107E)

Item	Details
Power voltage	3.5 V - 3.6 V
Capacity	700 mAh
Dimensions (mm)	31 mm x 21.5 mm x 43 mm (W x H x D)
Mass	Approx. 26 g

Memo :

- The specifications and appearance of this product are subject to changes for further improvement without prior notice.

JVC